

1140-LN-B

LINE INPUT TRANSFORMER
1:1 TURNS RATIO WITH DUAL SHIELDS

This transformer is designed for input stages with a wide bandwidth and low distortion. This transformer can be used for balancing input stages on any high impedance input

It also has excellent shielding from the mu metal can.

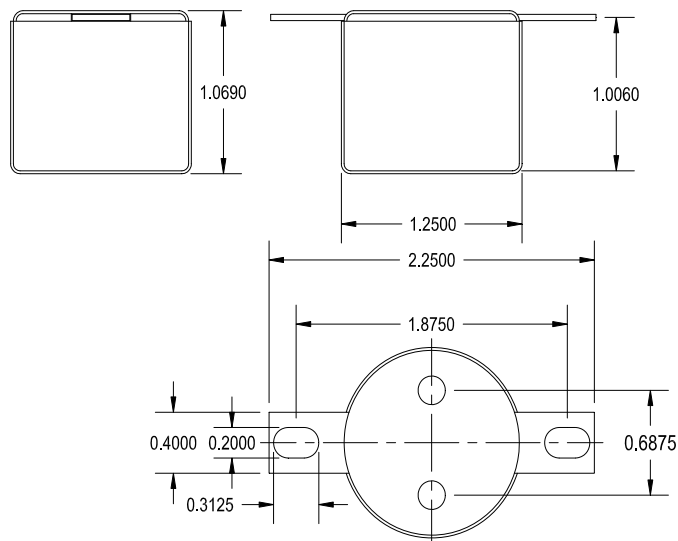

ELECTRICAL SPECIFICATIONS

Characteristic	Conditions	Typical
Input Impedance		10000 Ω
Output Impedance		10000 Ω
Primary Input Impedance	@ 1kHz +4dbu Test Circuit 3	12K Ω
Secondary Output Impedance	@ 1kHz +4dbu Test Circuit 4	2.1K Ω
Maximum input Level	@ 20Hz	+20.0db
DCR		
Primary	@20°C	1.03 K Ω
Secondary	@20°C	1.03 K Ω
Frequency Response	@ 20 Hz, +4 dbu, Test Circuit 3	-0.03db
	@ 20 kHz, +4 dbu, Test Circuit 3	+0.09db
Turns ratio		1:1
Common Mode Rejection Level	@ 60 Hz Test Circuit 2	70db
	3kHz Test Circuit 2	55db
THD	@ 1kHz -20 dbu Test Circuit 1	0.015%
	@ 20Hz -20 dbu Test Circuit 1	0.005%
Phase Shift	@ 20 Hz Test Circuit 1	1.0°
	@ 20 kHz Test Circuit 1	-10.0°
Capacitance	Primary to Shield and Case	525pf
	Secondary to Shield and Case	525pf
Dielectric Strength		500 Vrms



1140-LN-B

PRI:BRN - ORG: 10000 Ω GRY: SHIELD
SEC:GRN - GRN/YEL: 10000 Ω GRY/WHT: SHIELD

CAN GROUND: VIO
MADE IN CANADA DATE

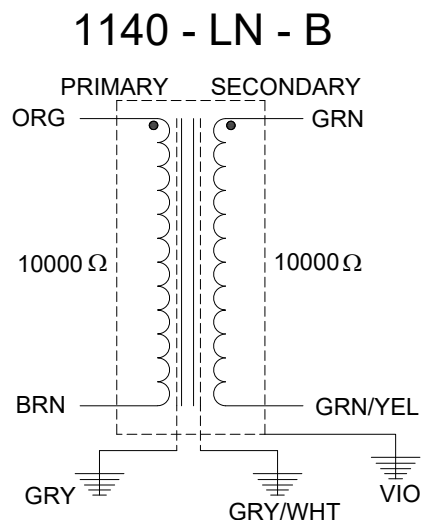

1140-LN-B FREQUENCY RESPONSE

Input Level +4dbu
Rs = 600Ω, RL = 10000Ω

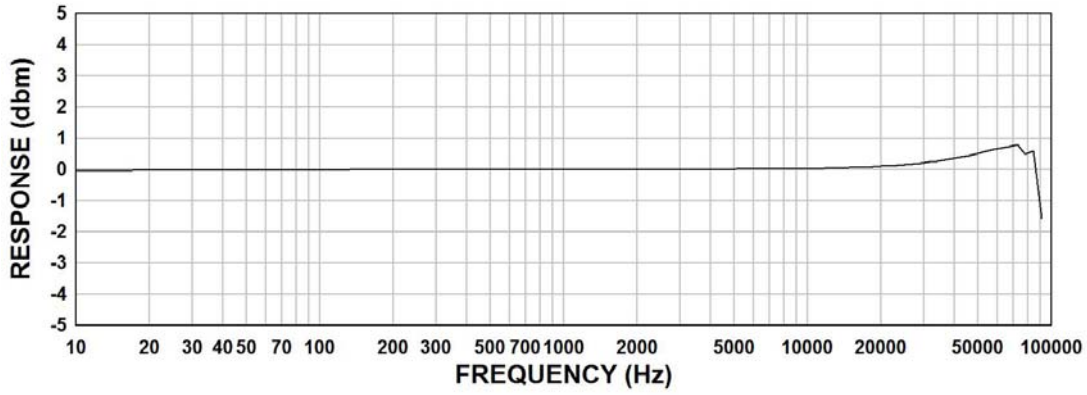

1140-LN-B PHASE SHIFT

Input Level +4dbu
Rs = 600Ω, RL = 10000Ω

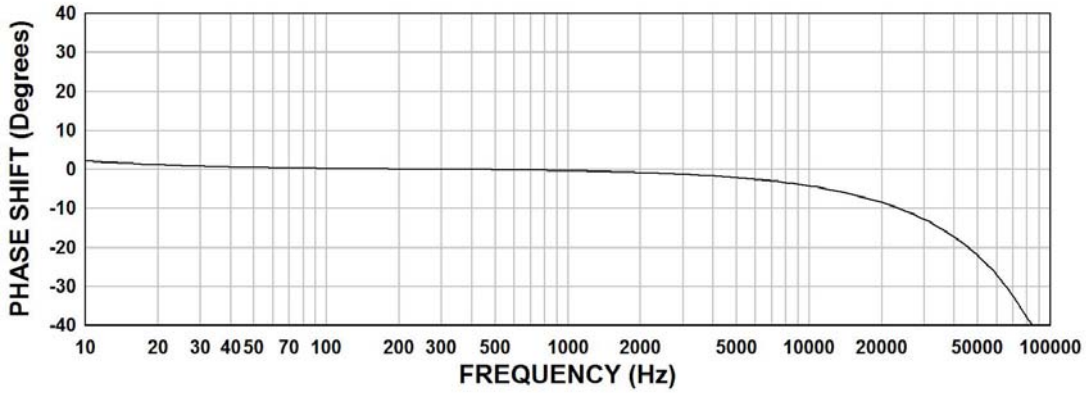

1140-LN-B THD + N

Input Level +4dbu
Rs = 600Ω, RL = 10000Ω

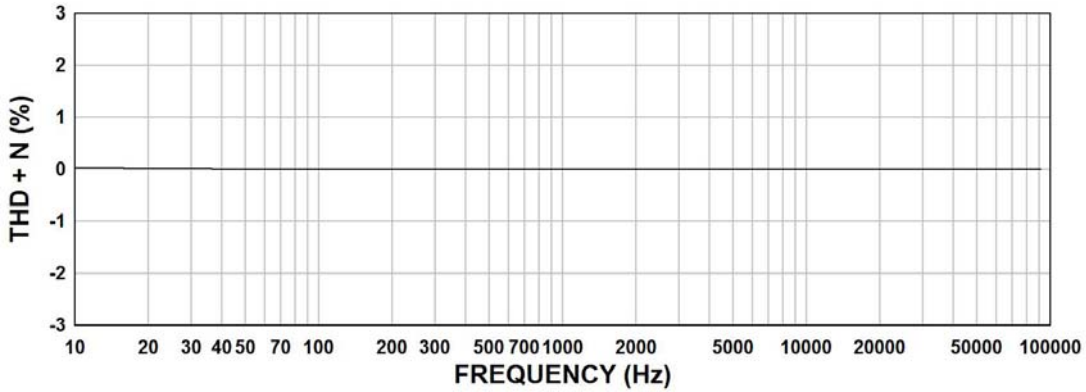

TYPICAL TEST CIRCUIT

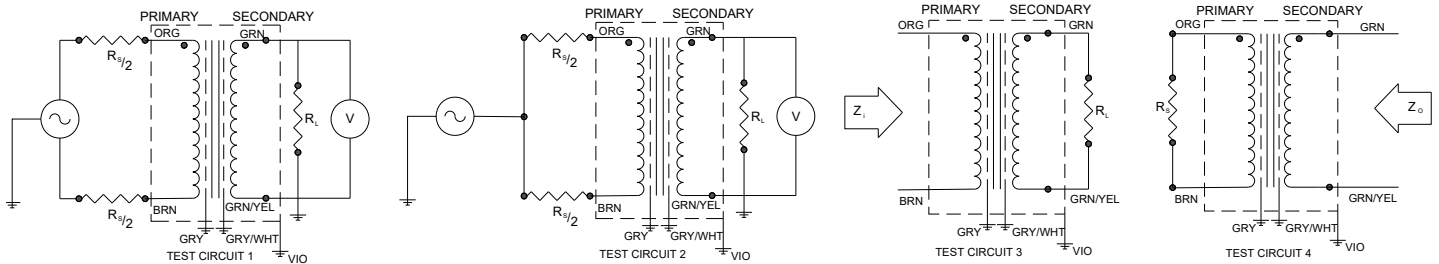

Measurement instruments: Hp4192a Impedance Analyzer; Hp3456a DVM; Keithley 2002 DVM; D scope series iii audio analyzer

This drawing and the information in it is the property of Hammond Manufacturing. It may not be reproduced, transmitted or used in any manner whatsoever without the written permission of Hammond Manufacturing. Data subject to change without notice.