

S Series Power MOSFET



RoHS
COMPLIANT
HALOGEN
FREE
Available

PRODUCT SUMMARY		
V_{DS} at T_J max. (V)	650	
$R_{DS(on)}$ max. at 25 °C (Ω)	$V_{GS} = 10$ V	0.190
Q_g max. (nC)	98	
Q_{gs} (nC)	17	
Q_{gd} (nC)	25	
Configuration	Single	

FEATURES

- Generation one
- High E_{AR} capability
- Lower figure-of-merit $R_{on} \times Q_g$
- 100 % avalanche tested
- Ultra low R_{on}
- dV/dt ruggedness
- Ultra low gate charge (Q_g)
- Material categorization: for definitions of compliance please see www.vishay.com/doc?99912

APPLICATIONS

- PFC power supply stages
- Hard switching topologies
- Solar inverters
- UPS
- Motor control
- Lighting
- Server telecom

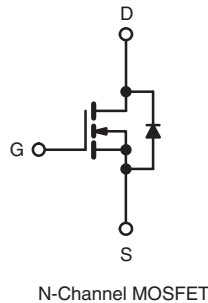
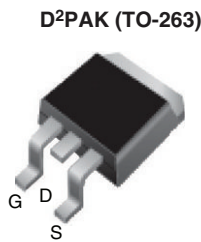

ORDERING INFORMATION	
Package	D ² PAK (TO-263)
Lead (Pb)-free and Halogen-free	SiHB22N60S-GE3
Lead (Pb)-free	SiHB22N60S-E3

ABSOLUTE MAXIMUM RATINGS ($T_C = 25$ °C, unless otherwise noted)					
PARAMETER	SYMBOL		LIMIT	UNIT	
Drain-Source Voltage	V_{DS}		600	V	
Gate-Source Voltage	V_{GS}		± 30		
Continuous Drain Current	V_{GS} at 10 V	$T_C = 25$ °C	22	A	
		$T_C = 100$ °C	13		
Pulsed Drain Current ^a	I_{DM}		65		
Linear Derating Factor	D ² PAK (TO-263)		2	W/°C	
Single Pulse Avalanche Energy ^b	E_{AS}		690	mJ	
Repetitive Avalanche Energy ^a	E_{AR}		25		
Maximum Power Dissipation	D ² PAK (TO-263)		P_D	250	W
Drain-Source Voltage Slope	$T_J = 125$ °C		dV/dt	37	V/ns
Reverse Diode dV/dt ^d				5.3	
Operating Junction and Storage Temperature Range	T_J, T_{stg}		-55 to +150	°C	
Soldering Recommendations (Peak Temperature) ^c	for 10 s		300		

Notes

- Repetitive rating; pulse width limited by maximum junction temperature.
- $V_{DD} = 50$ V, starting $T_J = 25$ °C, $L = 28.2$ mH, $R_g = 25$ Ω , $I_{AS} = 7$ A.
- 1.6 mm from case.
- $I_{SD} \leq I_D$, $dI/dt = 100$ A/ μ s, starting $T_J = 25$ °C.



THERMAL RESISTANCE RATINGS						
PARAMETER		SYMBOL	TYP.	MAX.	UNIT	
Maximum Junction-to-Ambient	D ² PAK (TO-263)	R _{thJA}	-	62	°C/W	
Maximum Junction-to-Case (Drain)	D ² PAK (TO-263)	R _{thJC}	-	0.5		

SPECIFICATIONS (T _J = 25 °C, unless otherwise noted)							
PARAMETER	SYMBOL	TEST CONDITIONS		MIN.	TYP.	MAX.	UNIT
Static							
Drain-Source Breakdown Voltage	V _{DS}	V _{GS} = 0 V, I _D = 1 mA		600	-	-	V
V _{DS} Temperature Coefficient	ΔV _{DS} /T _J	Reference to 25 °C, I _D = 1 mA		-	0.70	-	V/°C
Gate-Source Threshold Voltage (N)	V _{GS(th)}	V _{DS} = V _{GS} , I _D = 250 μA		2.0	-	4.0	V
Gate-Source Leakage	I _{GSS}	V _{GS} = ± 20 V		-	-	± 100	nA
		V _{GS} = ± 30 V		-	-	± 1	μA
Zero Gate Voltage Drain Current	I _{DSS}	V _{DS} = 600 V, V _{GS} = 0 V		-	-	1	μA
		V _{DS} = 600 V, V _{GS} = 0 V, T _J = 150 °C		-	-	100	
Drain-Source On-State Resistance	R _{DS(on)}	V _{GS} = 10 V	I _D = 11 A	-	0.160	0.190	Ω
Forward Transconductance ^a	g _{fs}	V _{DS} = 50 V, I _D = 13 A		-	9.4	-	S
Dynamic							
Input Capacitance	C _{iss}	V _{GS} = 0 V, V _{DS} = 25 V, f = 1.0 MHz		-	2810	-	pF
Output Capacitance	C _{oss}			-	1480	-	
Reverse Transfer Capacitance	C _{rss}			-	33	-	
Effective Output Capacitance (Time Related)	C _{oss eff. (TR)} ^a	V _{GS} = 0 V	V _{DS} = 0 V to 480 V	-	155	-	
Total Gate Charge	Q _g	V _{GS} = 10 V	I _D = 22 A, V _{DS} = 480 V	-	75	110	nC
Gate-Source Charge	Q _{gs}			-	17	-	
Gate-Drain Charge	Q _{gd}			-	25	-	
Turn-On Delay Time	t _{d(on)}	V _{DD} = 380 V, I _D = 22 A, R _g = 9.1 Ω, V _{GS} = 10 V		-	24	50	ns
Rise Time	t _r			-	68	100	
Turn-Off Delay Time	t _{d(off)}			-	77	115	
Fall Time	t _f			-	59	90	
Gate Input Resistance	R _g	f = 1 MHz, open drain		-	0.65	-	Ω
Drain-Source Body Diode Characteristics							
Continuous Source-Drain Diode Current	I _S	MOSFET symbol showing the integral reverse p - n junction diode 		-	-	22	A
Pulsed Diode Forward Current	I _{SM}			-	-	88	
Diode Forward Voltage	V _{SD}	T _J = 25 °C, I _S = 22 A, V _{GS} = 0 V		-	-	1.2	V
Reverse Recovery Time	t _{rr}	T _J = 25 °C, I _F = I _S , di/dt = 100 A/μs, V _R = 25 V		-	462	690	ns
Reverse Recovery Charge	Q _{rr}			-	8.3	16	μC
Reverse Recovery Current	I _{RRM}			-	30	60	A

Note

a. C_{oss eff. (TR)} is a fixed capacitance that gives the same charging time as C_{oss} while V_{DS} is rising from 0 % to 80 % V_{DS}.

TYPICAL CHARACTERISTICS (25 °C, unless otherwise noted)

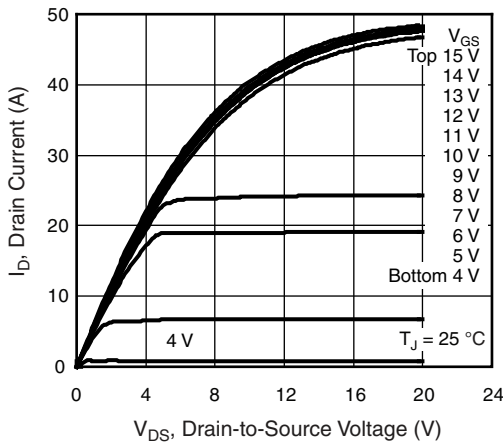

Fig. 1 - Typical Output Characteristics, $T_J = 25\text{ }^\circ\text{C}$

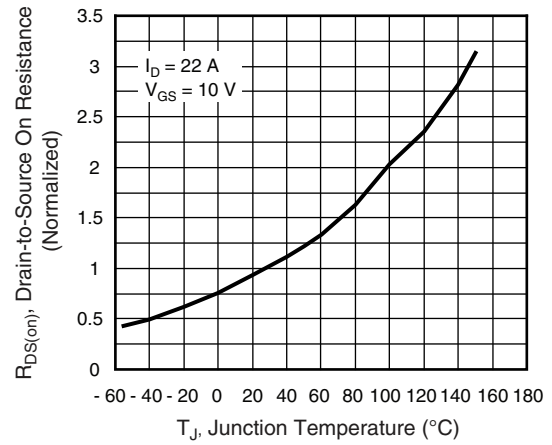

Fig. 4 - Normalized On-Resistance vs. Temperature

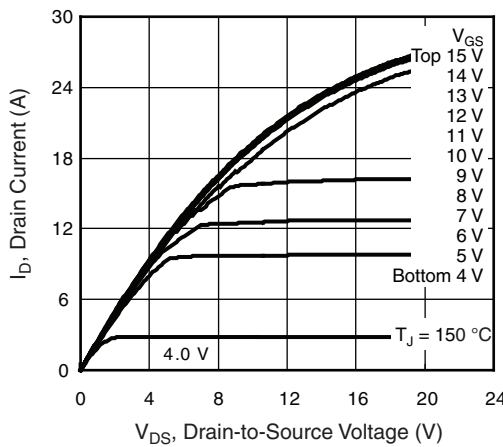

Fig. 2 - Typical Output Characteristics, $T_J = 150\text{ }^\circ\text{C}$

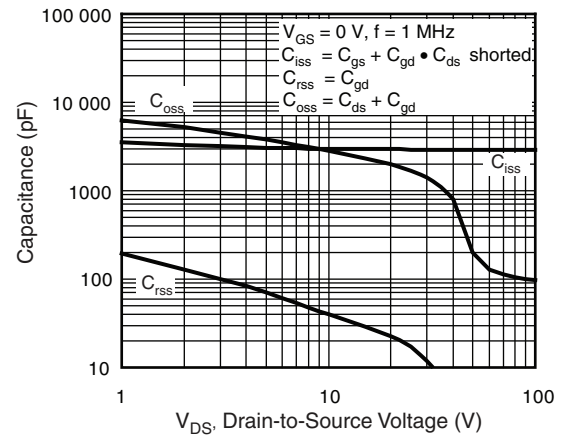

Fig. 5 - Typical Capacitance vs. Drain-to-Source Voltage

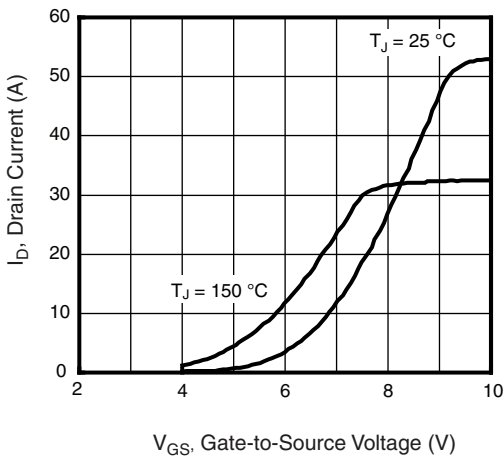

Fig. 3 - Typical Transfer Characteristics

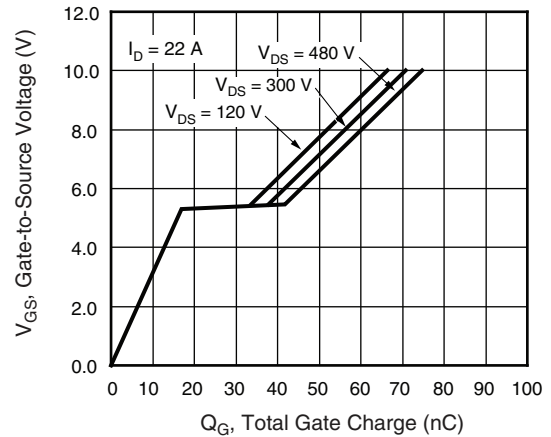

Fig. 6 - Typical Gate Charge vs. Gate-to-Source Voltage

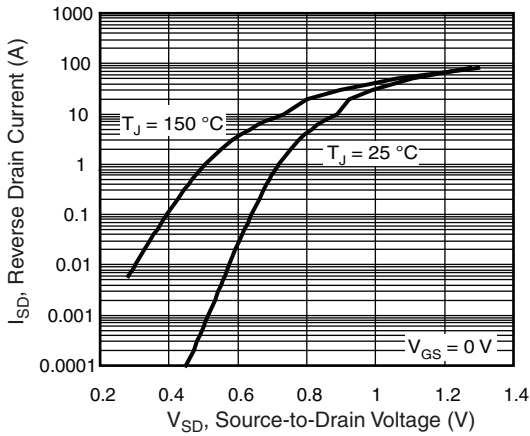

Fig. 7 - Typical Source-Drain Diode Forward Voltage

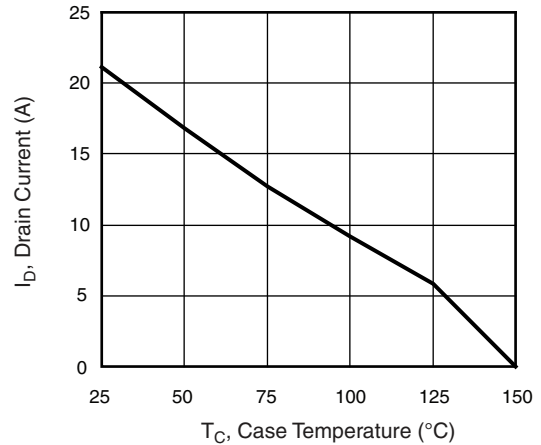

Fig. 9 - Maximum Drain Current vs. Case Temperature

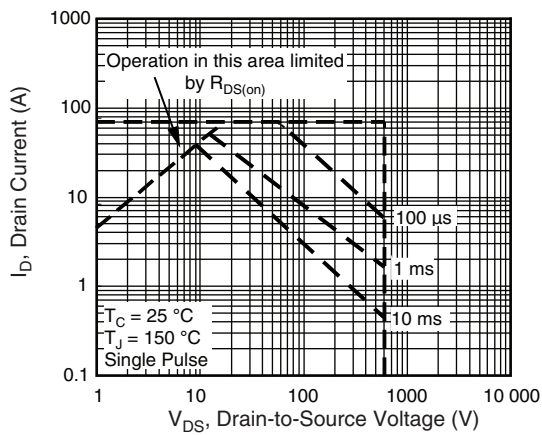

Fig. 8 - Maximum Safe Operating Area

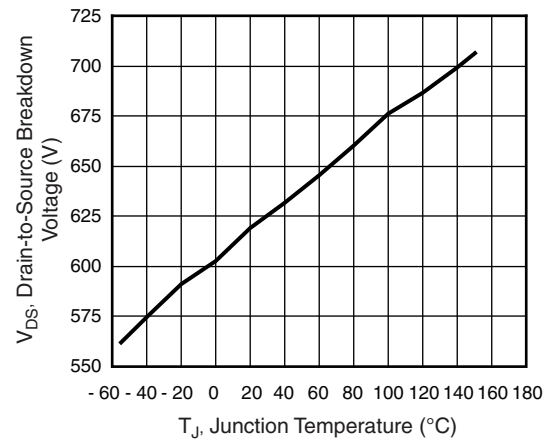

Fig. 10 - Drain-to-Source Breakdown Voltage

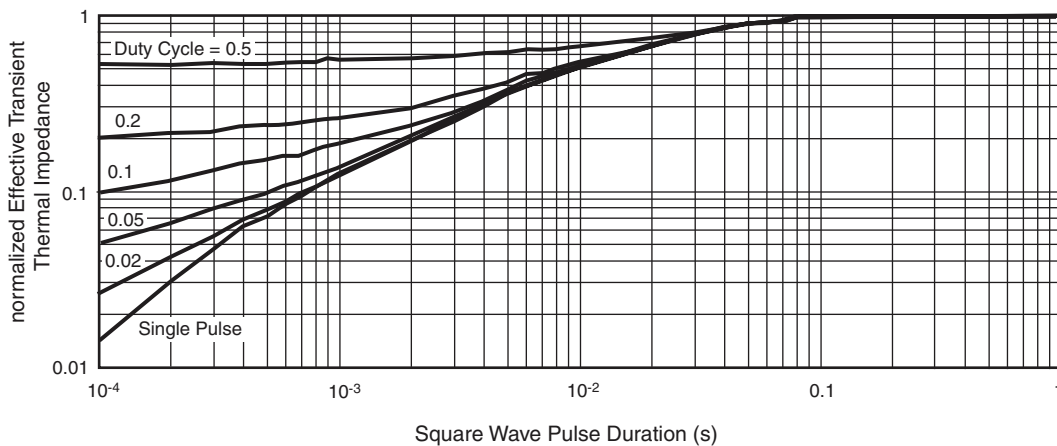

Fig. 11 - Normalized Thermal Transient Impedance, Junction-to-Case

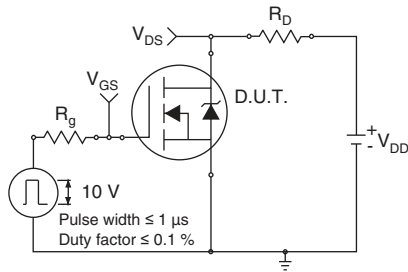

Fig. 12 - Switching Time Test Circuit

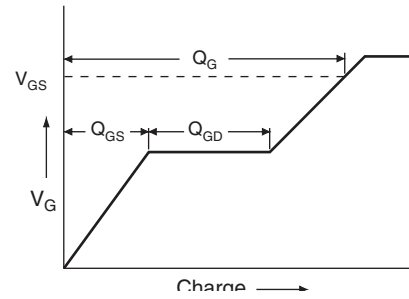

Fig. 16 - Basic Gate Charge Waveform

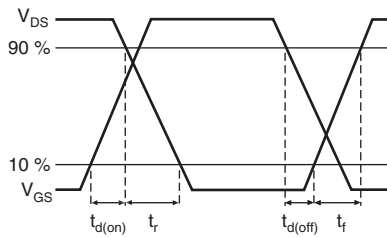

Fig. 13 - Switching Time Waveforms

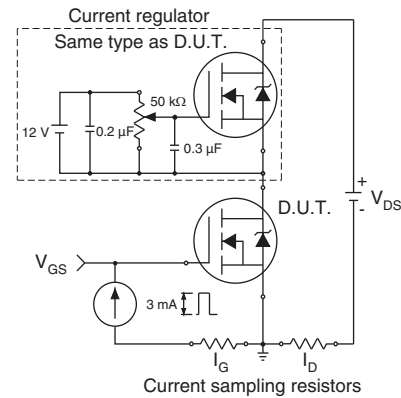

Fig. 17 - Gate Charge Test Circuit

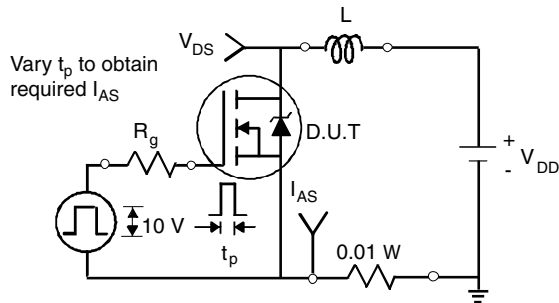

Fig. 14 - Unclamped Inductive Test Circuit

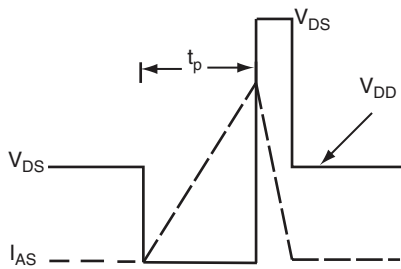
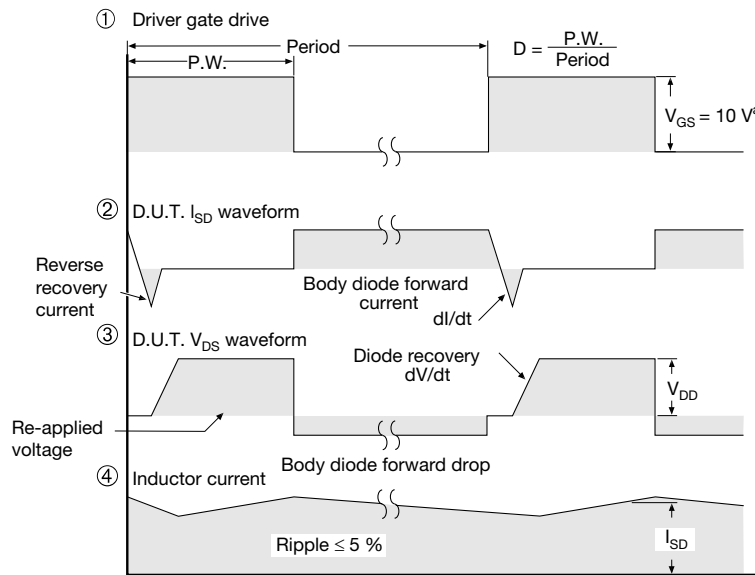
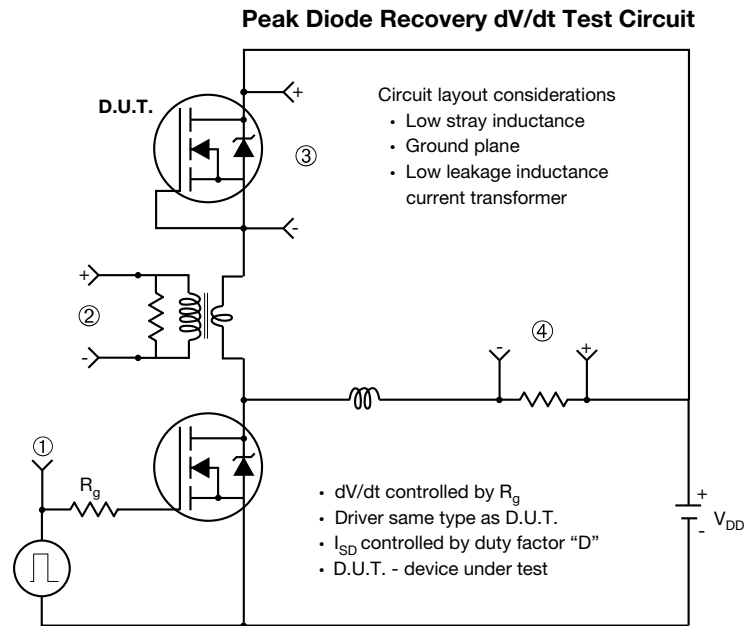

Fig. 15 - Unclamped Inductive Waveforms



Note

a. $V_{GS} = 5\text{ V}$ for logic level devices

Fig. 18 - For N-Channel

Vishay Siliconix maintains worldwide manufacturing capability. Products may be manufactured at one of several qualified locations. Reliability data for Silicon Technology and Package Reliability represent a composite of all qualified locations. For related documents such as package/tape drawings, part marking, and reliability data, see www.vishay.com/ppg?91395.



Disclaimer

ALL PRODUCT, PRODUCT SPECIFICATIONS AND DATA ARE SUBJECT TO CHANGE WITHOUT NOTICE TO IMPROVE RELIABILITY, FUNCTION OR DESIGN OR OTHERWISE.

Vishay Intertechnology, Inc., its affiliates, agents, and employees, and all persons acting on its or their behalf (collectively, "Vishay"), disclaim any and all liability for any errors, inaccuracies or incompleteness contained in any datasheet or in any other disclosure relating to any product.

Vishay makes no warranty, representation or guarantee regarding the suitability of the products for any particular purpose or the continuing production of any product. To the maximum extent permitted by applicable law, Vishay disclaims (i) any and all liability arising out of the application or use of any product, (ii) any and all liability, including without limitation special, consequential or incidental damages, and (iii) any and all implied warranties, including warranties of fitness for particular purpose, non-infringement and merchantability.

Statements regarding the suitability of products for certain types of applications are based on Vishay's knowledge of typical requirements that are often placed on Vishay products in generic applications. Such statements are not binding statements about the suitability of products for a particular application. It is the customer's responsibility to validate that a particular product with the properties described in the product specification is suitable for use in a particular application. Parameters provided in datasheets and / or specifications may vary in different applications and performance may vary over time. All operating parameters, including typical parameters, must be validated for each customer application by the customer's technical experts. Product specifications do not expand or otherwise modify Vishay's terms and conditions of purchase, including but not limited to the warranty expressed therein.

Except as expressly indicated in writing, Vishay products are not designed for use in medical, life-saving, or life-sustaining applications or for any other application in which the failure of the Vishay product could result in personal injury or death. Customers using or selling Vishay products not expressly indicated for use in such applications do so at their own risk. Please contact authorized Vishay personnel to obtain written terms and conditions regarding products designed for such applications.

No license, express or implied, by estoppel or otherwise, to any intellectual property rights is granted by this document or by any conduct of Vishay. Product names and markings noted herein may be trademarks of their respective owners.