

Apr.1.2017 Copyright 2017 HIROSE ELECTRIC CO., LTD. All Rights Reserved.

COUNT	DESCRIPTION OF REVISIONS	BY	CHKD	DATE	COUNT	DESCRIPTION OF REVISIONS	BY	CHKD	DATE
△				..	△				..
△				..	△				..
△				..	△				..

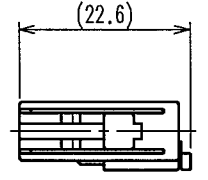

CONNECTOR ASSEMBLED WITH RETAINER

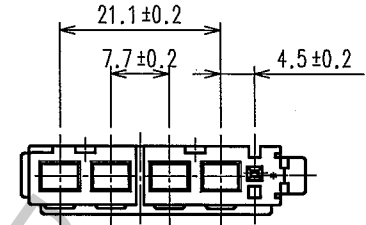
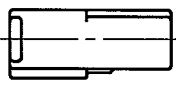
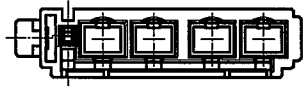
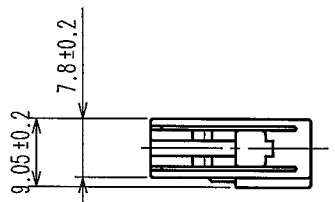
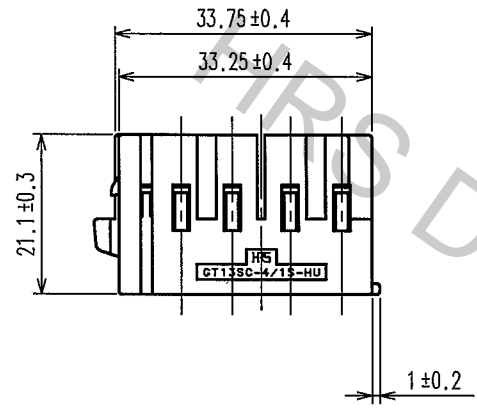
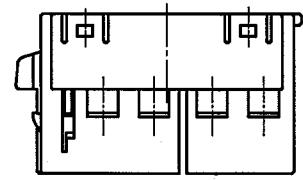

TO

NO.	MATERIAL	FINISH, REMARKS	NO.	MATERIAL	FINISH, REMARKS		
			1	PBT	LIGHT GRAY , UL94HB		
CODE NO. (OLD) CL			DRAWN	DESIGNED	CHECKED	APPROVED	RELEASED
			S.KURIYA	M.OKADA	K. Sato	K. Sato	
			'06.4.5	'01.6.28	06.4.5	06.4.5	..
DRAWING NO. EDC3-165783			PART NO. GT13SC-4/1S-HU				
SCALE 1 : 1			CODE NO. CL763-0021-0				
UNITS mm			1/1				

