

# **User Guide for FIS1100 Evaluation Kit**

(FEBFIS1100MEMS\_IMU6D3X)

6D Inertial Measurement Unit with Motion  
Co-Processor and Sensor Fusion Library

**Featured Fairchild Products:**  
FIS1100, FAN2558, FXL4TD245, FXMA2102

For technical support, please contact [Fairchild Semiconductor](#)  
or your local sales team [Fairchild Sales Offices](#)

## Table of Contents

1. Introduction.....	3
1.1. Description .....	3
1.2. Features .....	4
1.3. Applications .....	4
1.4. Evaluation Board Block Diagram .....	5
2. Evaluation Board Specifications.....	7
3. Photographs.....	8
4. Getting Started with MT Manager.....	9
4.1. FIS1100 SDK Installation .....	9
4.2. Installed Software.....	10
4.3. Hardware Connection.....	10
4.4. Using MT Manager .....	11
5. Printed Circuit Board (PCB).....	22
6. Schematics .....	23
7. Bill of Materials (BOM) .....	26
8. Testing MCU power consumption.....	28
9. Revision History .....	29

## 1. Introduction

This user guide supports the evaluation kit for the FIS1100. The FIS1100 evaluation kit is designed to support your evaluation of the system performance, accuracy and features using the easy to use MT Manager Windows GUI application, as well as to support your hardware integration and embedded software integration efforts using the extensive FIS1100 SDK.

The FIS1100 evaluation kit should be used in conjunction with the FIS1100 datasheets as well as Fairchild's application notes and technical support team. Please visit Fairchild's website at [www.fairchildsemi.com](http://www.fairchildsemi.com).

This document describes the evaluation system for the FIS1100 in combination with the XKF3 sensor fusion library, reference drivers for the FIS1100 (source code) and an example sensor fusion project for ARM Cortex-M microcontrollers. The document contains general information to help the user get started with evaluating the solution, install the FIS1100 SDK and includes an introduction to the MT Manager software, and demonstrates the advantage of the FIS1100 AttitudeEngine™ for building accurate low power 3D motion tracking solutions.

### 1.1. Description

The FIS1100 is the world's first complete consumer 6D MEMS Inertial Measurement Unit (IMU) with sensor fusion to specify system level orientation accuracy. When using the FIS1100 in combination with the supplied XKF3 9D sensor fusion, the system features an accurate  $\pm 3^\circ$  pitch and roll orientation, and a  $\pm 5^\circ$  yaw/heading typical specification.

The FIS1100 incorporates a 3-axis Gyroscope and a 3-axis Accelerometer and can connect an external 3-axis magnetometer through an I<sup>2</sup>C master thus forming a complete 9DOF system.

The FIS1100 also incorporates an advanced vector Digital Signal Processor (DSP) motion co-processor called the AttitudeEngine. The AttitudeEngine efficiently encodes high frequency motion at high internal sampling rates, preserving full accuracy across any output data rate.

This enables the application to utilize low Output Data Rates (ODR) or on-demand (host polling) and still acquire accurate 3D motion data. The AttitudeEngine allows reducing the data processing and interrupt load on a host processor with no compromises in 3D motion tracking accuracy. The result is very low total system power in combination with high accuracy, which are essential to many portable and battery powered applications.

The XKF3 sensor fusion library for ARM Cortex-M provides a robust sensor fusion solution based on Xsens' more than 15 years of experience in the industrial and human movement motion tracking fields. The XKF3 sensor fusion algorithm is optimized for use with the FIS1100 AttitudeEngine to provide high accuracy orientation and high-pass 3D velocity outputs at very low processor utilization.

## 1.2. Features

- FIS1100 6D Inertial Measurement Unit
  - World’s First Complete Consumer Inertial Measurement Unit (IMU) with Sensor Fusion Library to Specify Orientation Accuracy:  $\pm 3^\circ$  Pitch and Roll,  $\pm 5^\circ$  Yaw/Heading
  - 3-Axis Gyroscope and 3-Axis Accelerometer in a Small 3.3 x 3.3 x 1 mm LGA Package
  - Integrated AttitudeEngine Motion Co-processor with Vector DSP Performs Sensor Fusion at 1 kHz Sampling Rate, while Outputting Data to Host Processor at a Lower Rate – Improving Accuracy while Reducing Processor MIPS, Power, and Interrupt Requirements
  - Complete System Solution for 3D Motion Tracking, Optimized 9D Sensor Fusion Library (XKF3) Featuring in-use Auto-Calibration Enabling Accurate 3D Orientation (quaternion) and High-Pass 3D Velocity Motion Tracking
  - Large 1536 Byte FIFO can be used to Buffer 9DOF Sensor Data to Lower System Power Dissipation
  - New Motion on Demand Technology for Polling Based Synchronization
  - Large Dynamic Range from  $\pm 32$  dps to  $\pm 2,560$  dps and  $\pm 2$  g to  $\pm 8$  g
  - Low Latency, High-Resolution OIS Mode
  - Low Noise 50  $\mu\text{g}/\sqrt{\text{Hz}}$  Accelerometer and 10 mdps/ $\sqrt{\text{Hz}}$  Gyroscope
  - Low Power and Warm-Start Modes for Effective Power Management
  - Digitally Programmable Sampling Rate and Filters
  - Host Serial Interface Supporting I<sup>2</sup>C or SPI
  - I<sup>2</sup>C Master for Interfacing External Magnetometer
  - Embedded Temperature Sensor
  - Wide Extended Operating Temperature Range (-40°C to 85°C)
- XKF3 9D Sensor Fusion Library
  - Continuous Sensor Auto Calibration, No User Interaction Required
  - Real-Time, Low-Latency Optimal estimate of 3D Orientation
  - Best-in-Class Immunity to Magnetic Distortions
  - Best-in-Class Immunity to Transient Accelerations
  - Flexible use Scenarios, North Referenced, Unreferenced
  - Extensive Status Reporting for Smooth Integration in Applications
  - Optimized Library for Popular Microcontrollers

## 1.3. Applications

- Sport & Fitness Tracking
- Wearable and Health Monitoring
- Pedestrian Navigation
- Light Industrial, Robotics and Autonomous Machines
- Natural User Interfaces, Gaming, VR/AR
- GNSS Augmentation and Dead Reckoning
- Optical Video and Image Stabilization

### 1.4. Evaluation Board Block Diagram

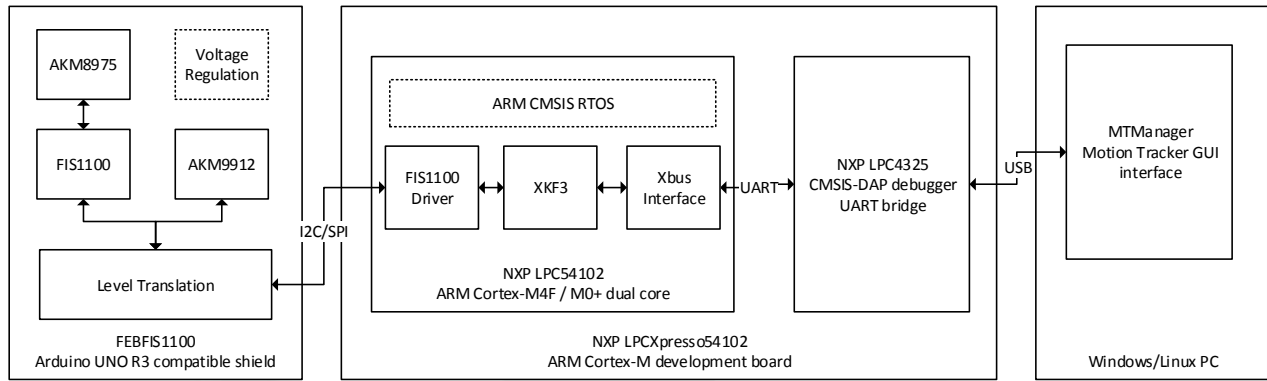
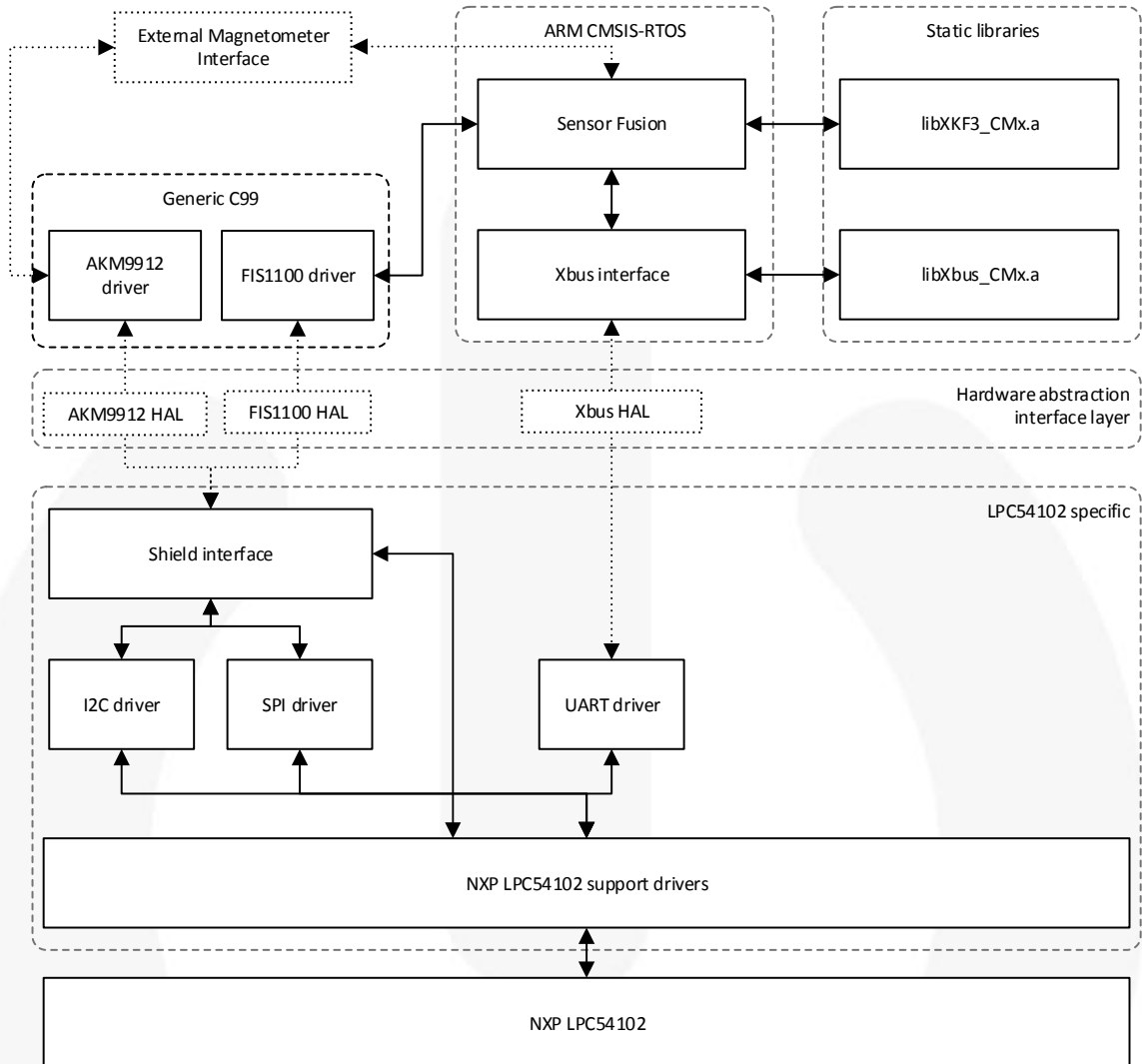

Figure 1. FEBFIS1100MEMS\_IMU6D3X Block Diagram



**Figure 2. Firmware Component Overview**

## 2. Evaluation Board Specifications

Table 1. FEBFIS1100MEMS\_IMU6D3X Arduino Uno-R3 Shield Electrical Specifications

Description	Symbol	Min	Nominal	Max	Comments
Input Voltage	VIN	3.1 V	3.3 V, 5 V	5.5 V	Choice of voltage input pin controlled by placement of R100 or R101 0-Ohm resistors
IO Reference voltage	IOREF	1.65 V		3.65 V	
Voltage on any other pin		GND		IOREF	

Table 2. FEBFIS1100MEMS\_IMU6D3X System Level 3D Orientation Accuracy Specifications

Subsystem	Parameter	Typical	Unit	Comments
<b>FIS1100+XKF3 quaternions</b>	Roll	±3	deg	Requires use of XKF3 software library on host processor.
	Pitch	±3	deg	Requires use of XKF3 software library on host processor.
	Yaw (Heading) Referenced to North	±5	deg	Requires use of XKF3 software library on host processor, using magnetometer, in a homogenous Earth magnetic field.
	Yaw (Heading) Unreferenced	5-25	deg/h	From Allan Variance bias instability. Does not require a magnetometer. <i>(See spec above for use with magnetometer.)</i> Fully immune to magnetic distortions.
<b>FIS1100+XKF3 quaternions</b>	Output Data Rate	8 - 1000	Hz	To benefit from the power saving using the AttitudeEngine, use a max ODR of 64 Hz.

### 3. Photographs

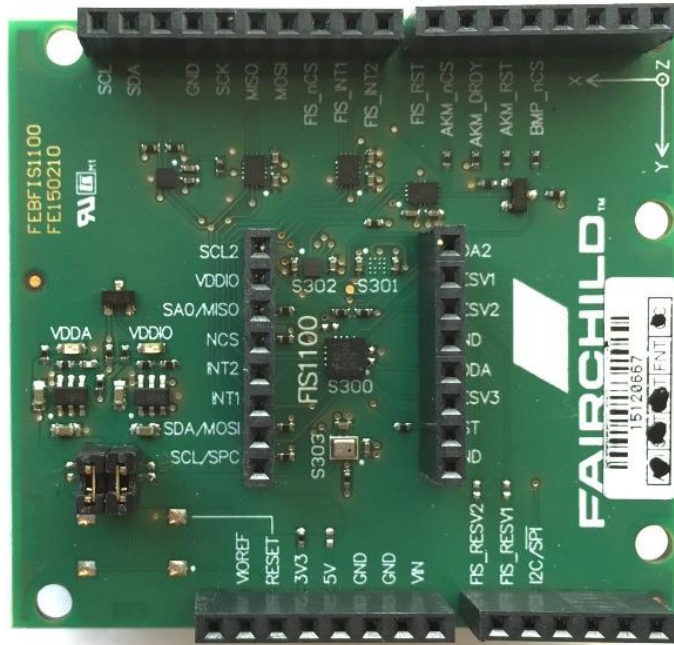

Figure 3. FEBFIS1100MEMS\_IMU6D3X Shield Board (Arduino UNO R3 Compatible)

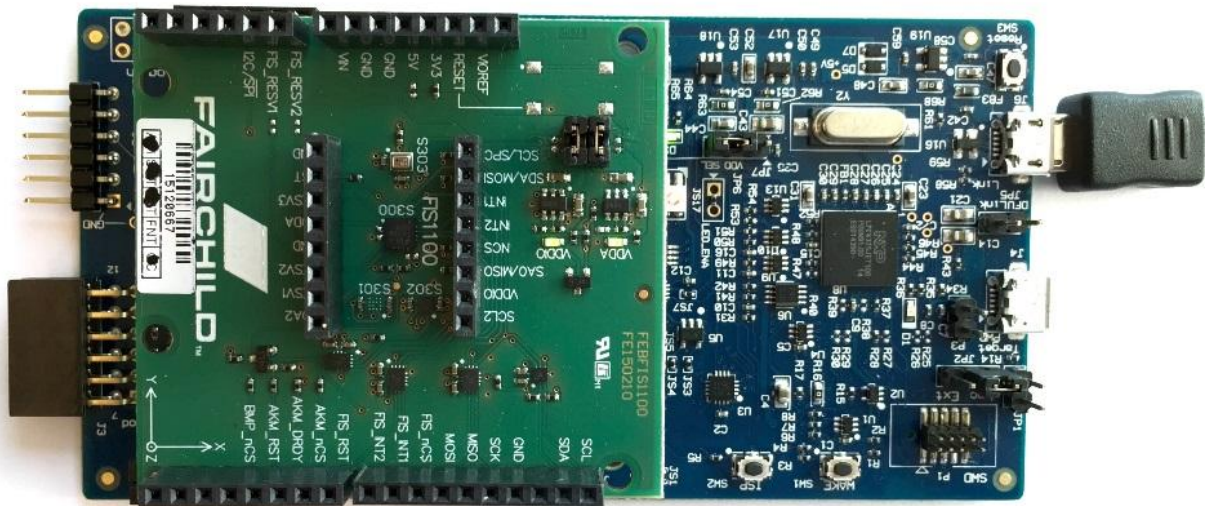

Figure 4. FEBFIS1100MEMS\_IMU6D3X Shield Board Mounted on NXP LPCXpresso54102 MCU Evaluation Board



## 4. Getting Started with MT Manager

### 4.1. FIS1100 SDK Installation

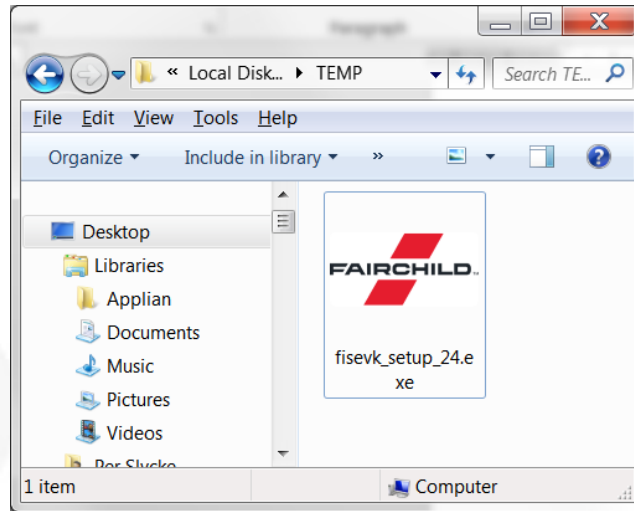

Figure 5. Execute the FIS1100 SDK Installer

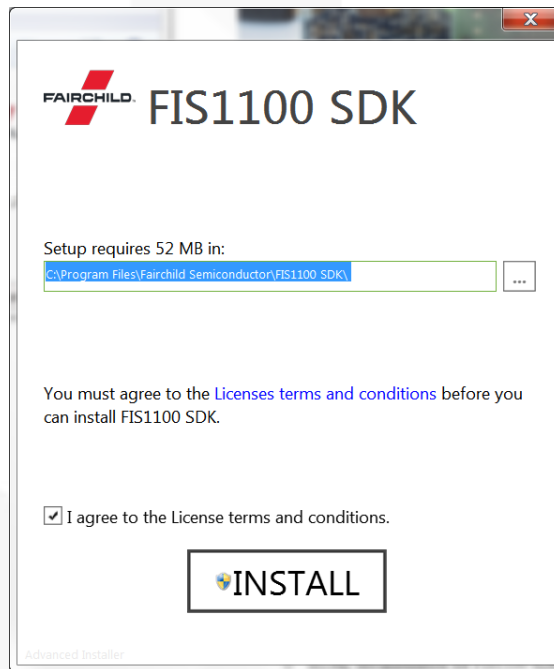

Figure 6. Carefully Review the License Terms and if applicable agree to them to install the FIS1100 SDK

## 4.2. Installed Software

Installed Software Includes:

- **Fairchild MT Manager**
  - GUI to Control FIS1100 Evaluation Board Settings
  - Visualize Real Time Data Streams as Graphs
  - Visualize Real Time 3D Orientation
  - Record Data (ASCII) for Offline Analysis
  - Playback Recorded Data for Offline Analysis
- **FIS1100 Software Development Kit (SDK)**
  - HTML Documentation for FIS1100 SDK, Including XKF3 API
  - High Level C99 Driver for FIS1100
  - XKF3 Libraries for Cortex-M0, M3 and M4F Cores
  - ARM CMSIS-RTOS Reference Implementation for using FIS1100 Driver with XKF3 Library
  - Example Firmware for NXP LPCXpresso5412
  - System Integration Documentation
- **NXP LPCXpresso5412 Board USB Driver**
  - USB UART Emulation
  - ARM CMSIS-DAP Debug Support
  - MCU Power Consumption Measurement<sup>(1)</sup>

## 4.3. Hardware Connection

The FEBFIS1100MEMS\_IMU6D3X “shield” board should be mounted onto the Arduino compatible MCU board as shown in Figure 4. The MCU board should then be connected to the host PC via a USB cable connected to JP6 as shown in Figure 7

For normal use, the DFULink jumper JP5 should be removed before the USB cable is connected to the host PC<sup>(2)</sup>

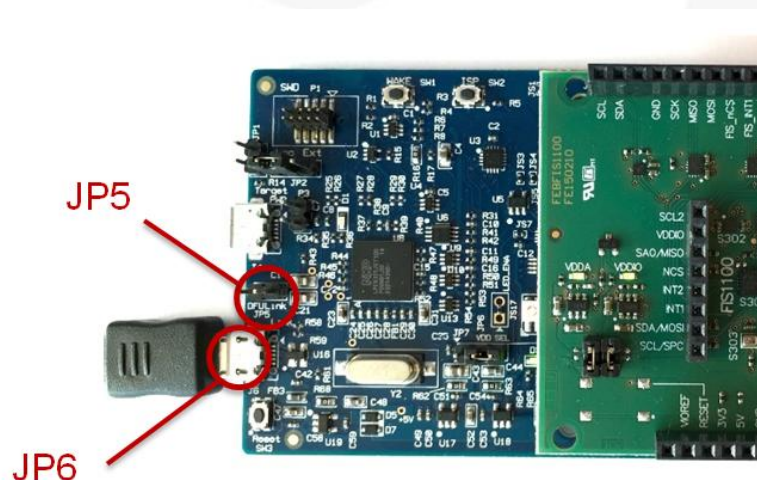

Figure 7. Location of USB connection (J6) and DFULink jumper (JP5)

### Notes:

1. Requires additional tools from NXP to be installed.
2. JP5 can be used to enable firmware upload to support MCU power measurements.

## 4.4. Using MT Manager

### Connecting to Evaluation Systems

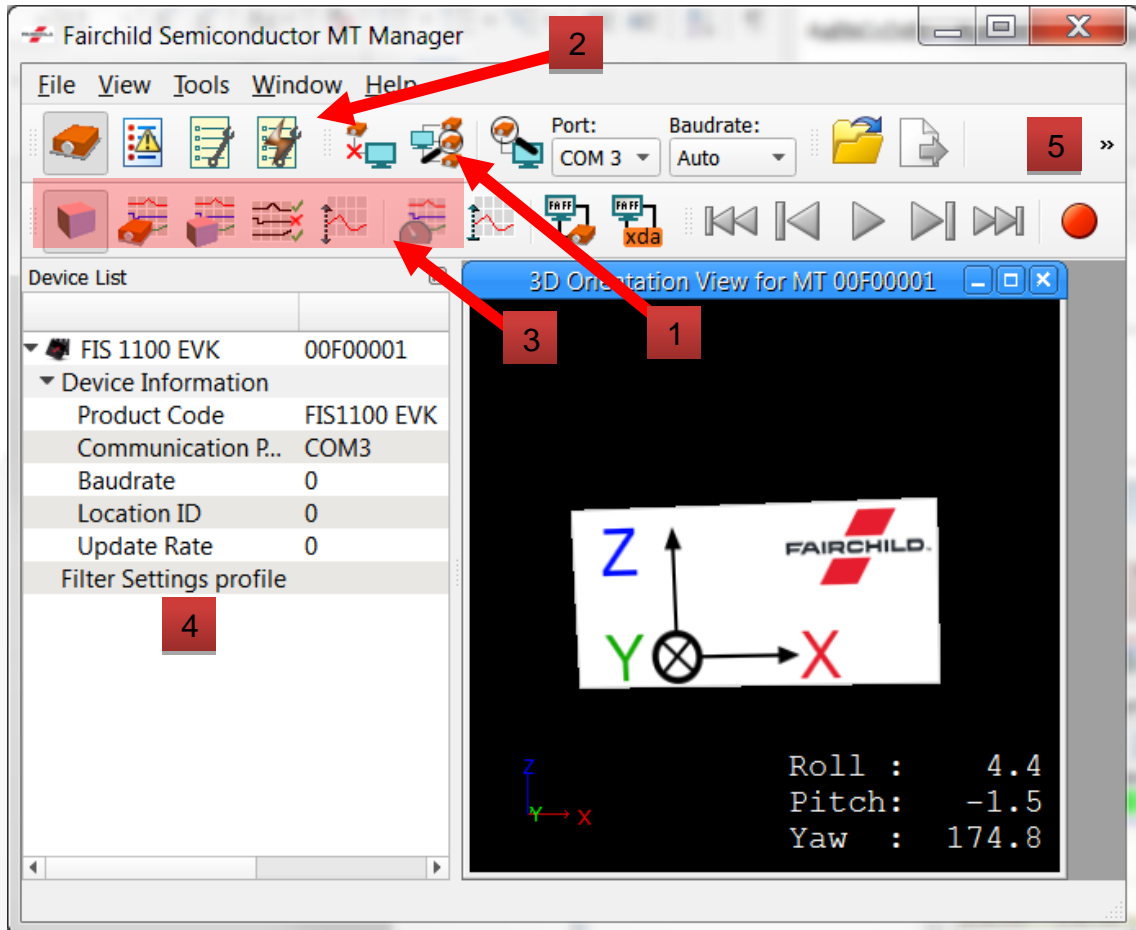

Figure 8. MT Manager GUI

With the FEBFIS1100MEMS\_IMU6D3X evaluation kit connected to the PC via USB, and drivers installed, start the MT Manager software. The software automatically scans for connected systems and displays these in the device list (4). If the MT Manager software is started before the evaluation board is connected, the scan buttons (1) can be used to rescan for a connected evaluation kit. Alternatively press the *F5* key to rescan for a connected evaluation kit.

With an evaluation kit selected in the device list the system operating parameters can be controlled by opening the output configuration panel (2).

Data from attached evaluation boards can be visualized by selecting one or more the visualization buttons (3).

Data from the evaluation system can be recorded to file for off-line analysis using the record button (5). Data is recorded in a custom binary file format (.mtb), which can be exported to ASCII data (File/Export) for easy analysis in other tools.

### Configuring the FIS1100 Evaluation Kit

Clicking on the output configuration button (2) will open the output configuration dialog for the devices selected in the device list (3)

The output configuration dialog allows the major functions of the FIS1100 and XKF3 fusion library to be configured.

**Note:**

3. If only a single device is connected it is automatically selected.

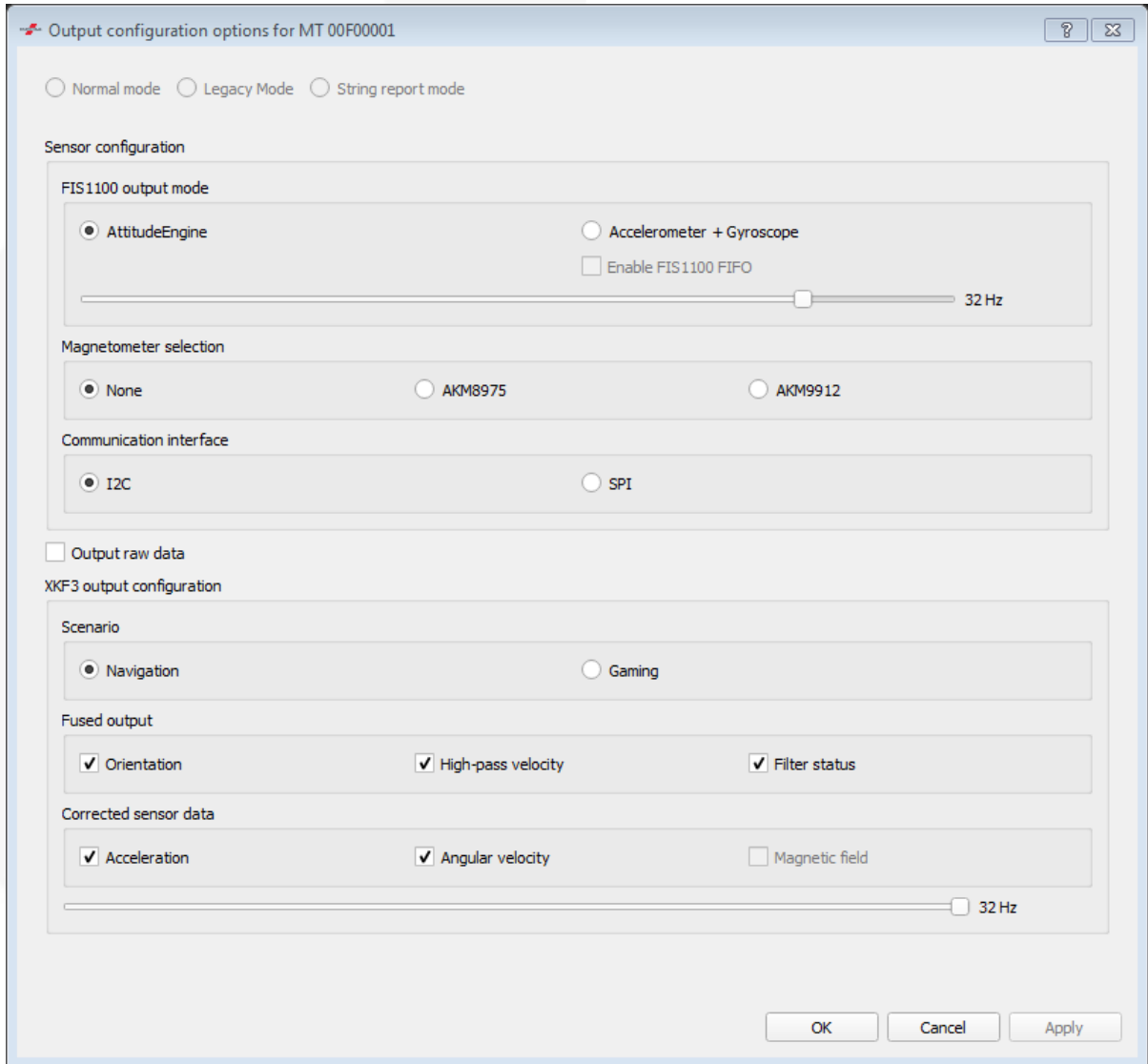

Figure 9. FEBFIS1100MEMS\_IMU6D3X Output Configuration Dialog



**Table 3. FEBFIS1100MEMS\_IMU6D3X Output Configuration Options**

Section	Option	Comments
FIS1100 output mode	AttitudeEngine	Uses the FIS1100 Attitude Engine to process data at 1 kHz and output orientation and velocity increments at the selected ODR
	Accelerometer + Gyroscope	Outputs raw accelerometer and gyroscope data at the selected ODR
	Enable FIS1100 FIFO	Enables the FIS1100 FIFO to reduce data interrupt frequency. This option is only available in Accelerometer + Gyroscope mode.
Magnetometer selection	None	Disables magnetometer support.
	AKM8975	Enables the FIS1100 support for a slaved AK8975C magnetometer.
	AKM9912	Enables firmware controlled sampling of the AKM9912 magnetometer
Communication interface	SPI	Uses SPI for communication with sensor components on the FEBFIS1100MEMS_IMU6D3X shield. Note that once SPI communication has been selected the evaluation board must be reset to return to I <sup>2</sup> C mode.
	I <sup>2</sup> C	Uses I <sup>2</sup> C for communication with sensor components on the FEBFIS1100MEMS_IMU6D3X shield
Output Raw Input Data		Enables sending raw sensor data values to MT Manager
Scenario	Navigation	The 3D orientation output from the XKF3 fusion library is referenced to the local magnetic north and will actively track North based on the Earth magnetic field.
	Gaming	Disables north referenced output, use this scenario if you do not need North referenced data and want the smoothest possible 3D orientation output. If magnetometer data is available, yaw drift will be reduced further.
Fused Outputs	Orientation	Enables sending the XKF3 orientation output to MT Manager
	Filter Status	Enables sending XKF3 status flags to MT Manager
	High-pass Velocity	Enables sending XKF3 high-pass velocity output to MT Manager
Corrected Sensor Data	Acceleration	Enables sending XKF3 corrected acceleration data to MT Manager
	Angular Velocity	Enables sending XKF3 corrected angular velocity (gyroscope) data to MT Manager
	Magnetic Field	Enables sending XKF3 corrected magnetometer data to MT Manager

### Visualizing Sensor Data

MT Manager provides real time visualization of data sent from the evaluation system.



#### 3D Orientation View

The 3D Orientation View provides a representation of the 3D orientation of the evaluation board. The view is orientated such that the user is looking from North to South at the evaluation board.

The 'Orientation' output must be enabled in the output configuration options dialog to use this view.

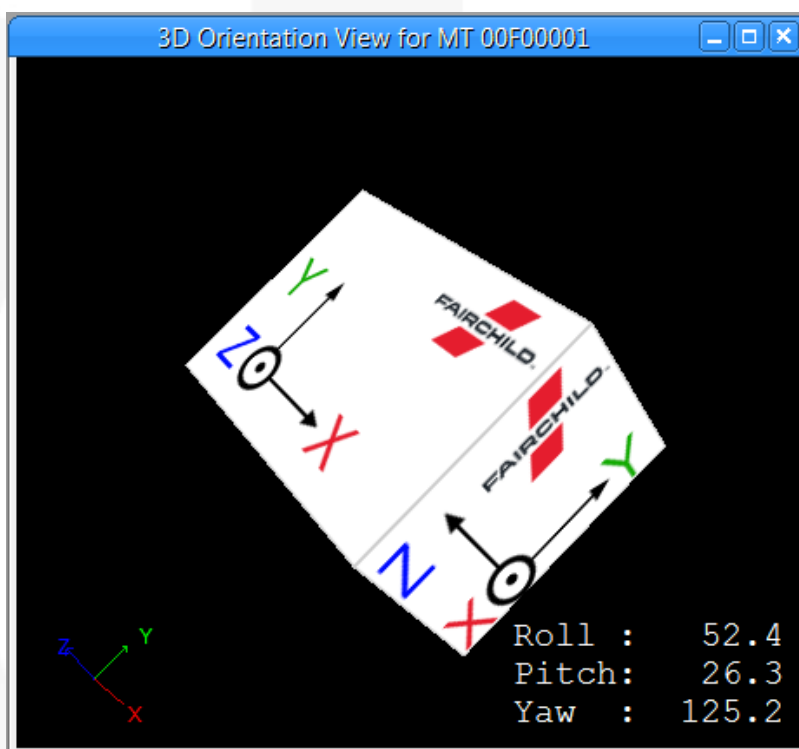

Figure 10. 3D Orientation View



#### Inertial Data View

The Inertial Data view provides graphical visualization of the inertial and magnetic field data output by the XKF3 fusion library. The XKF3 fusion library corrects for typical sensor errors such as gyroscope biases and magnetic hard and soft-iron distortions.

The 'Corrected Sensor Data' options in the output configuration options dialog control which sensor data types are available for visualization.

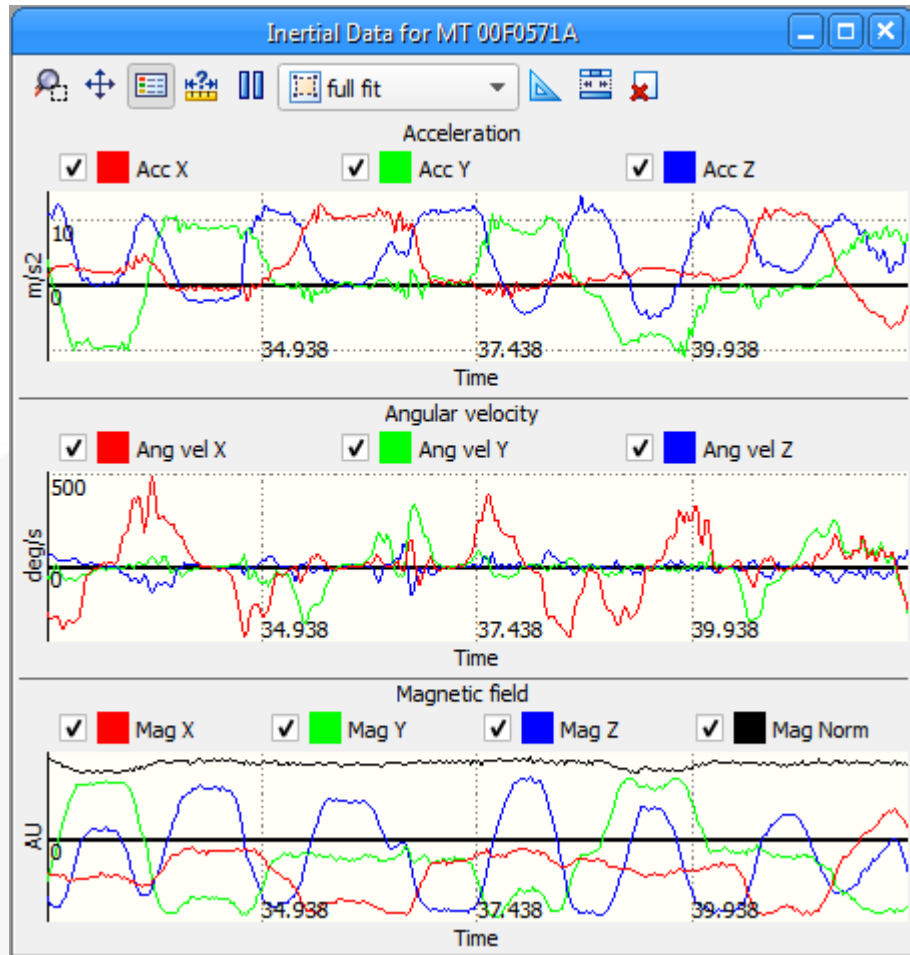
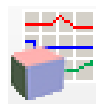

Figure 11. Inertial Data View

### Euler/Quaternion Orientation Data View



The Euler/Quaternion Orientation Data views provide graphical visualization of the orientation of the evaluation board. The choice of visualization mode can be made in the Tools → Preferences → MT Manager → Graphs configuration dialog.

The 'Orientation' output must be enabled in the output configuration options dialog to use this view.

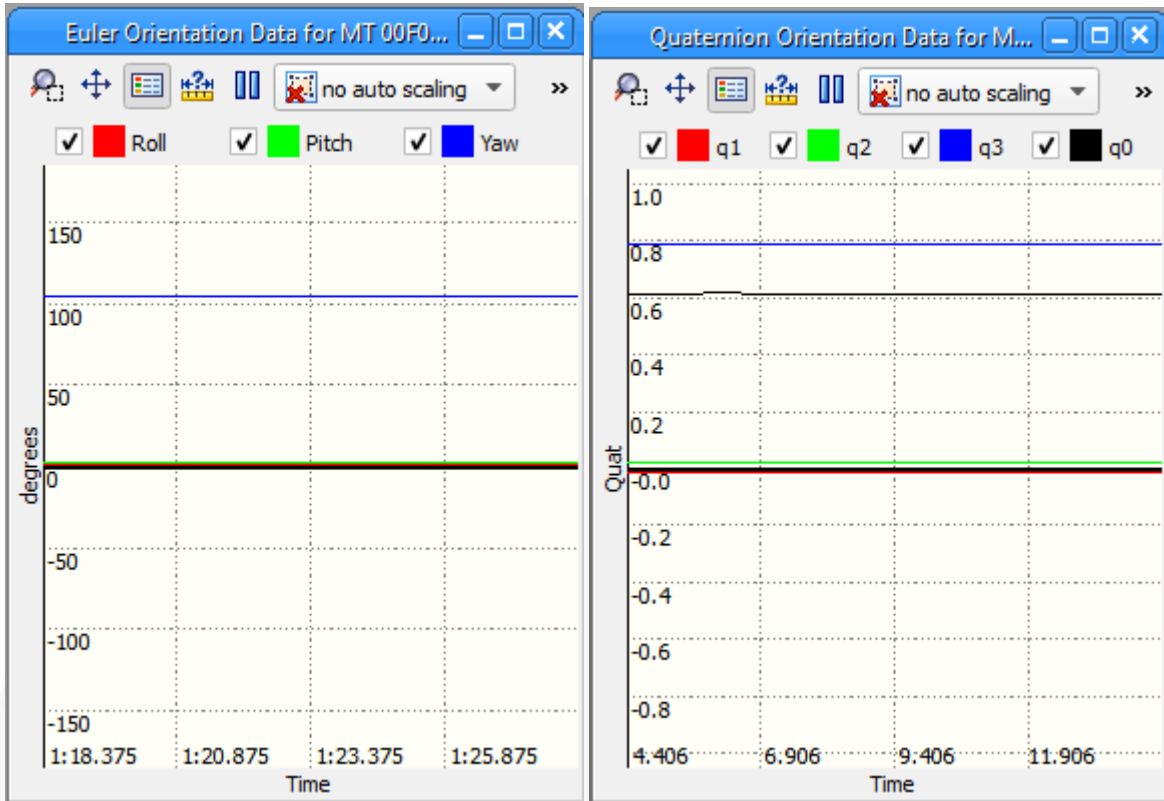

Figure 12. Euler/Quaternion Orientation Data Views



### Status Data View

The Status Data view provides a graphical representation of the XKF3 fusion library status flags. These status flags are provided by XKF3 to provide applications feedback on problems with the input sensor data that might affect the quality of the fused output quantities.

The 'Filter Status' output must be enabled in the output configuration options dialog to use this view.



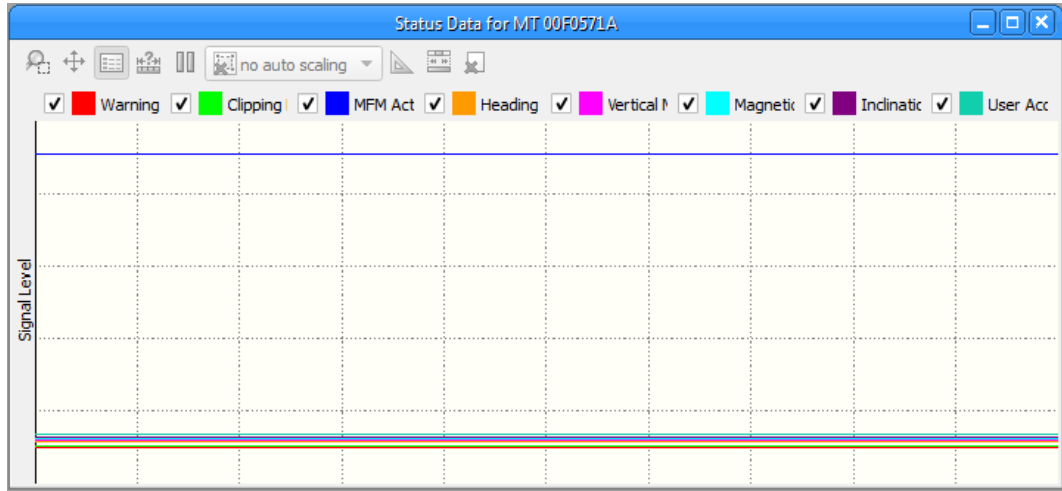
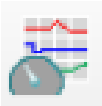

Figure 13. Status Data View

Table 4. XKF3 Status Flag Descriptions

Flag	Description
Warning	High value indicates that the output of XKF3 should not be trusted. Details of possible causes can be found in the subsequent flags.
Clipping Detected	High indicates that one or more sensors have exceeded their dynamic range.
MFM Active	High indicates that automatic magnetometer calibration is active and a new calibration is being determined.
Heading Unreliable	High indicates that the heading of the system cannot be determined accurately. The 'Vertical Mag Field' and 'Magnetic Distortion' flags may provide further details.
Vertical Mag Field	High indicates that the local magnetic field is close to vertical (aligned with gravity).
Magnetic Distortion	High indicates that the local magnetic field is distorted.
Inclination Warning	High indicates that the inclination (roll/pitch) of the system cannot be determined accurately. The 'User Acc Warning' flag may provide further details.
User Acc Warning	High indicates that the acceleration of the system violates the XKF3 model assumption (that the average acceleration is zero within some time period). This can happen when accelerating for long times, such as in a car.

### Velocity Data View



The Velocity Data view provides a graphical representation of the XKF3 fusion library's high pass velocity output. The high pass velocity output is designed for tracking short term motion of the system, such as gestures of the arm with respect to the torso.

The 'High-pass Velocity' option must be enabled in the output configuration options dialog to use this view.

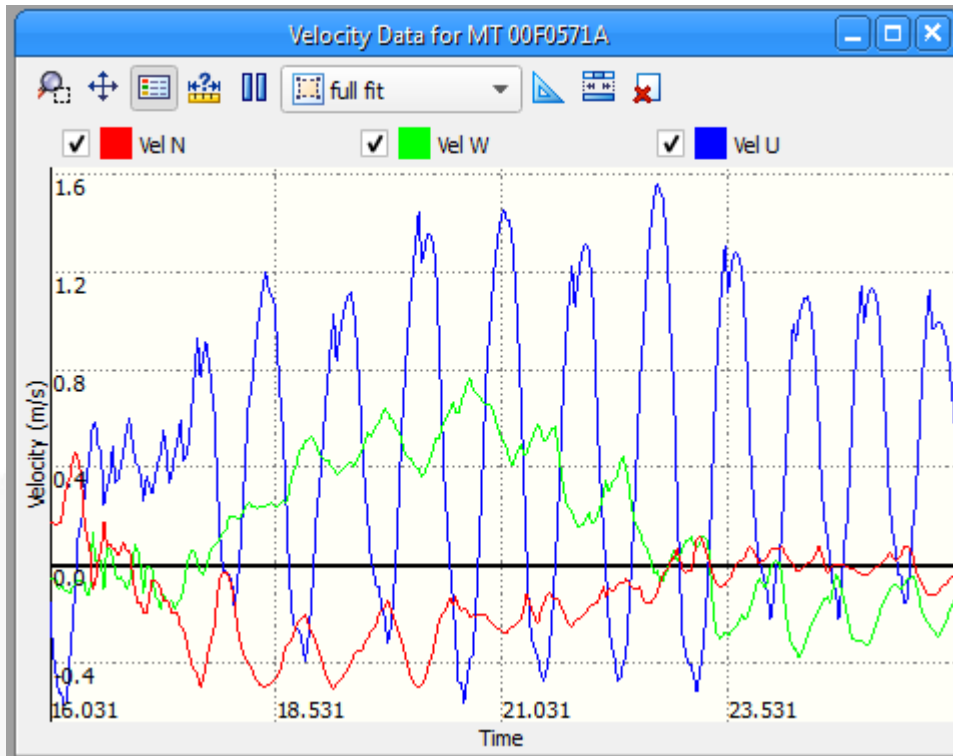

Figure 14. HP Velocity Data View

### Device context menu

Right clicking on the FIS1100 SDK device in the Device List provides a context menu with three options:

- Sleep – Wake on Motion: Selecting this menu item places the evaluation kit into wake on motion mode. The FIS1100 will be configured to provide an interrupt on detecting motion that will wake the MCU from sleep.
- Store filter state: Selecting this menu item requests the evaluation kit to save the XKF3 filter state to non-volatile storage. This allows the automatically estimated calibration parameters to be stored over power cycles, resulting in better startup performance.
- Disconnect: Selecting this menu item will disconnect the MTManager GUI from the evaluation kit.

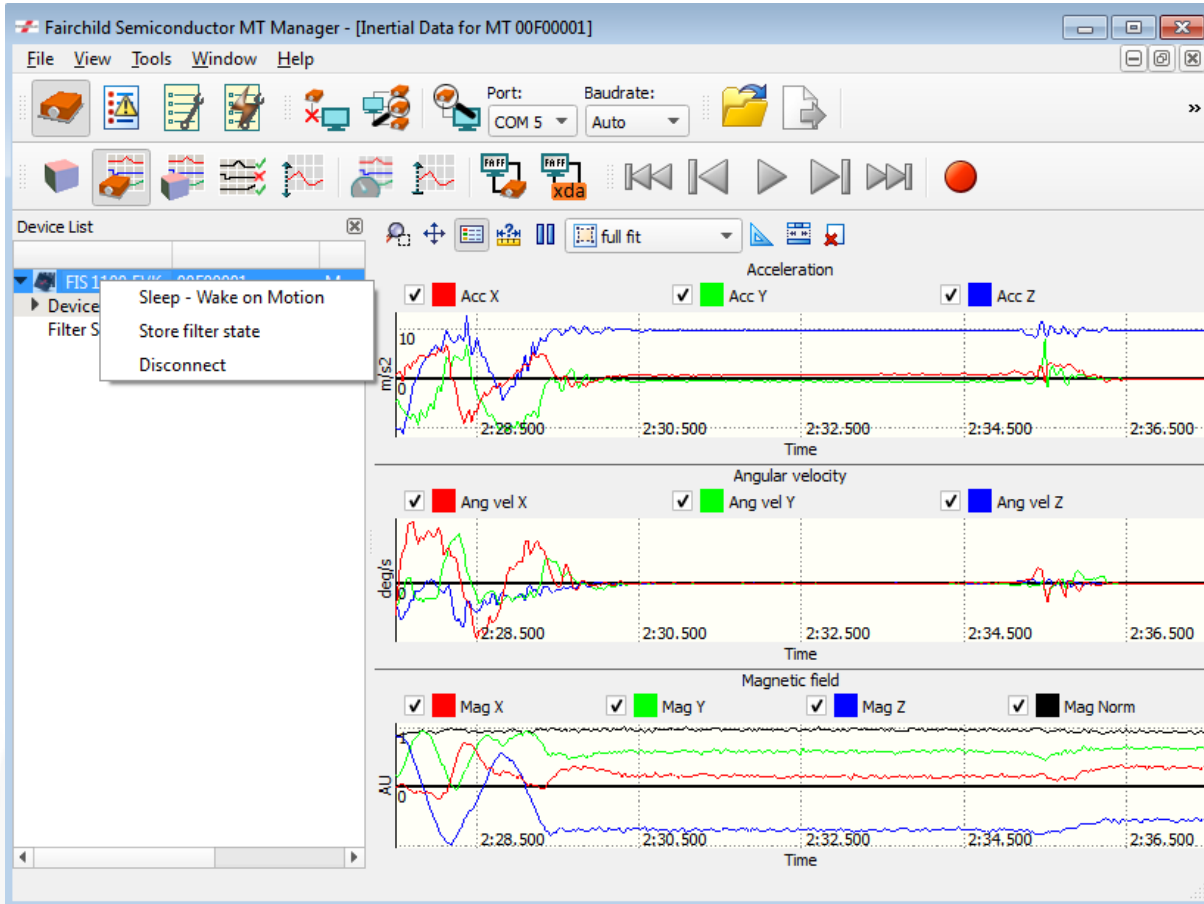



Figure 15. Device Context Menu Available on Right Clicking on FIS1100 SDK Device in Device List

### Recording and Exporting Data

Data from the evaluation system can be recorded to file for off-line analysis using the record button , see Figure 8. The data to record should be configured in the output configuration dialog prior to starting recording.

Data is recorded in a custom binary file format (.mtb). Recorded data in .mtb format can be exported to ASCII format for analysis in external tools. The data fields to export can be selected in the Tools->Preferences dialog as show in Figure 16.

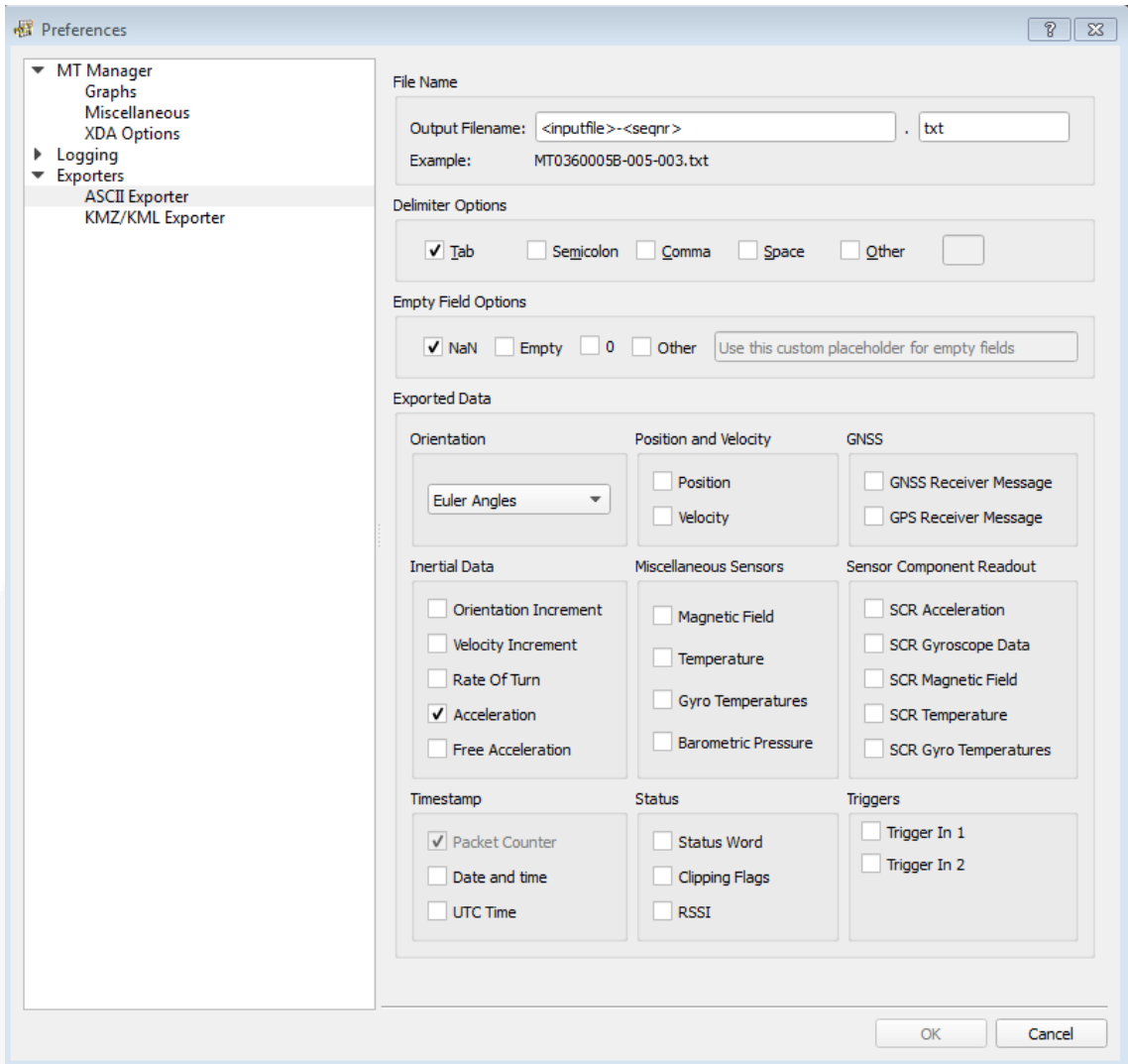

Figure 16. MT Manager ASCII Export Configuration



**Table 5. FEBFIS1100MEMS\_IMU6D3X Export Options**

Section	Option	Description	Comments
Orientation	None	Don't output orientation data	
	Quaternion	Output orientation as unit quaternion	Orientation output must be selected in output configuration options dialog for this data to be available for export.
	Euler Angles	Output orientation as Euler angles	
	Matrix	Output orientation as rotation matrix	
Position and Velocity	Position		Not supported by FEBFIS1100MEMS_IMU6D3X
	Velocity	Output high pass velocity data	High pass velocity output must be selected in output configuration dialog for this data to be available for export.
GNSS			
Inertial Data	Orientation Increment		Not supported by FEBFIS1100MEMS_IMU6D3X
	Velocity Increment		
	Rate of Turn	Output XKF3 corrected gyroscope data	Rate of Turn output must be selected in output configuration dialog for this data to be available for export.
	Acceleration	Output XKF3 corrected acceleration data	Accelerometer output must be selected in output configuration dialog for this data to be available for export
	Free Acceleration		Not supported by FEBFIS1100MEMS_IMU6D3X
Miscellaneous Sensors	Magnetic Field	Output XKF3 corrected magnetic field data	Magnetic Field output must be selected in output configuration dialog for this data to be available to export
	Temperature		Not supported by FEBFIS1100MEMS_IMU6D3X
	Gyro Temperatures		
	Barometric Pressure		
Sensor Component Readout	SCR Acceleration	Raw acceleration samples from the FIS1100	Output Raw Input Data must be selected in output configuration dialog for this data to be available to export
	SCR Gyroscope Data	Raw gyroscope samples from the FIS1100	
	SCR Magnetic Field	Raw magnetometer samples	
	SCR Temperature		Not supported by FEBFIS1100MEMS_IMU6D3X
	SCR Gyro Temperature		
Timestamp			
Status	Status Word	Output XKF3 status flags	Filter Status output must be selected in output configuration dialog for this data to be available to export.
	Clipping Flags		Not supported by FEBFIS1100MEMS_IMU6D3X
	RSSI		
Triggers			

## 5. Printed Circuit Board (PCB)

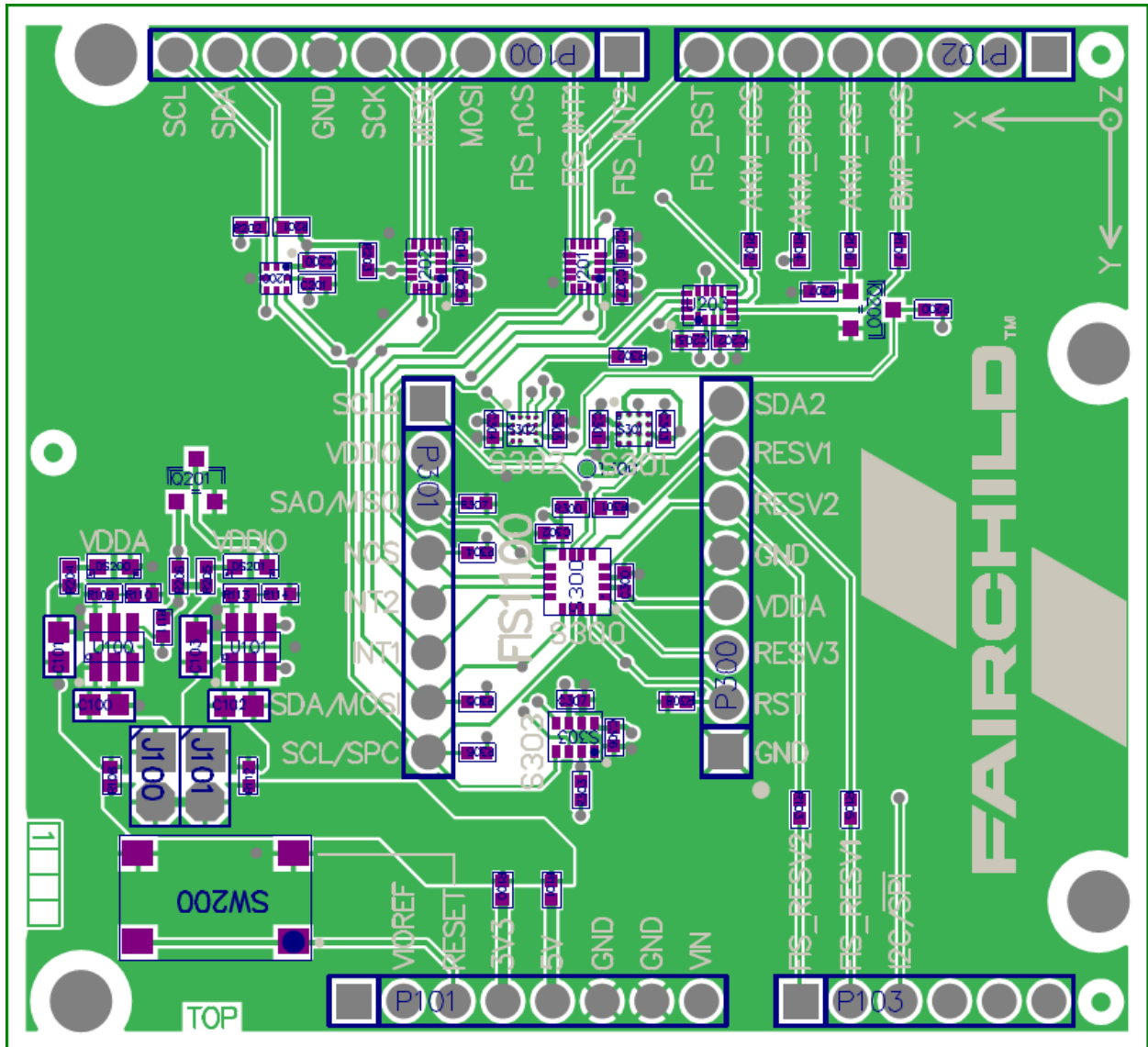

Figure 17. Top Side

## 6. Schematics

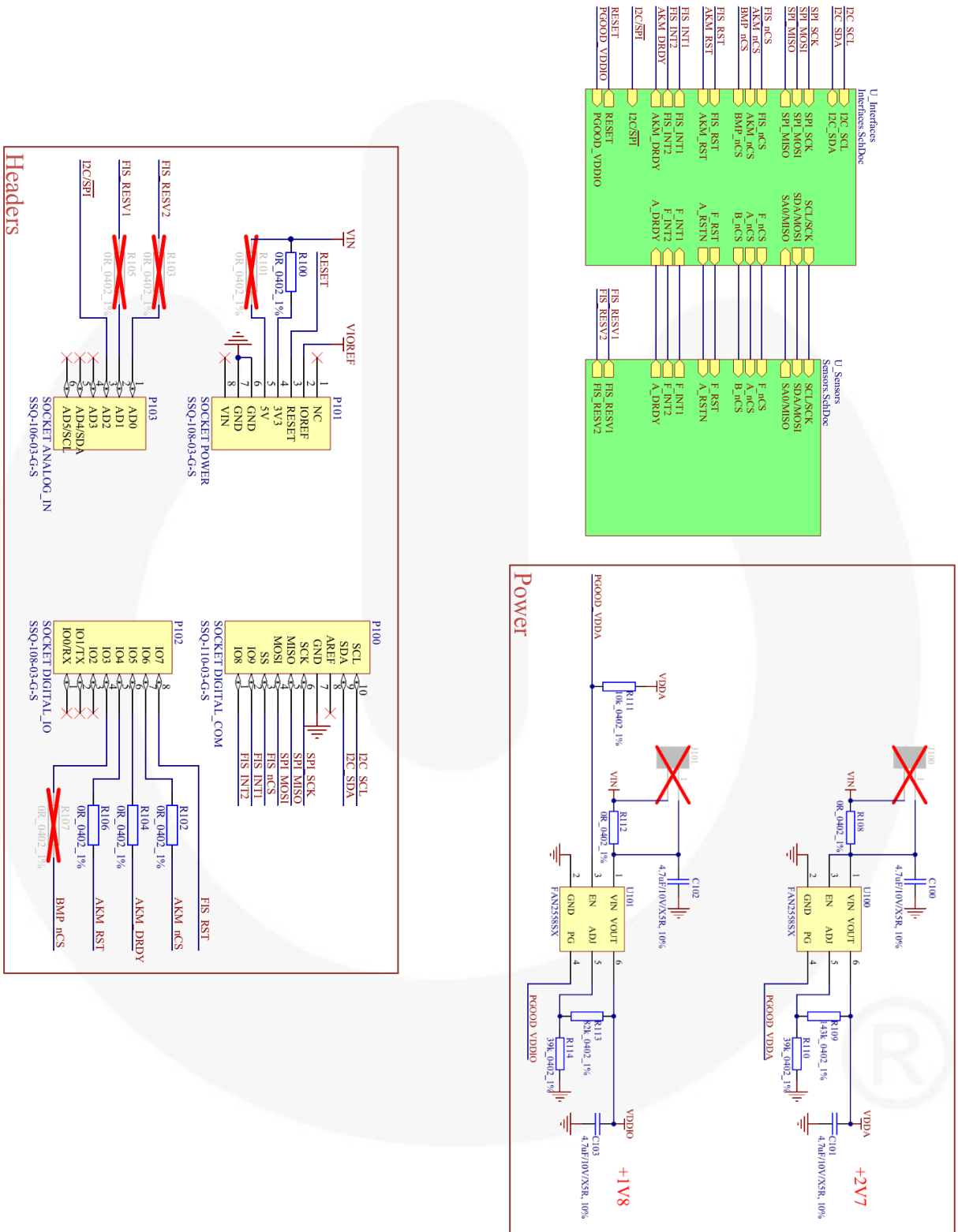

Figure 18. FEBFIS1100MEMS\_IMU6D3X Evaluation Board Schematic (Main)

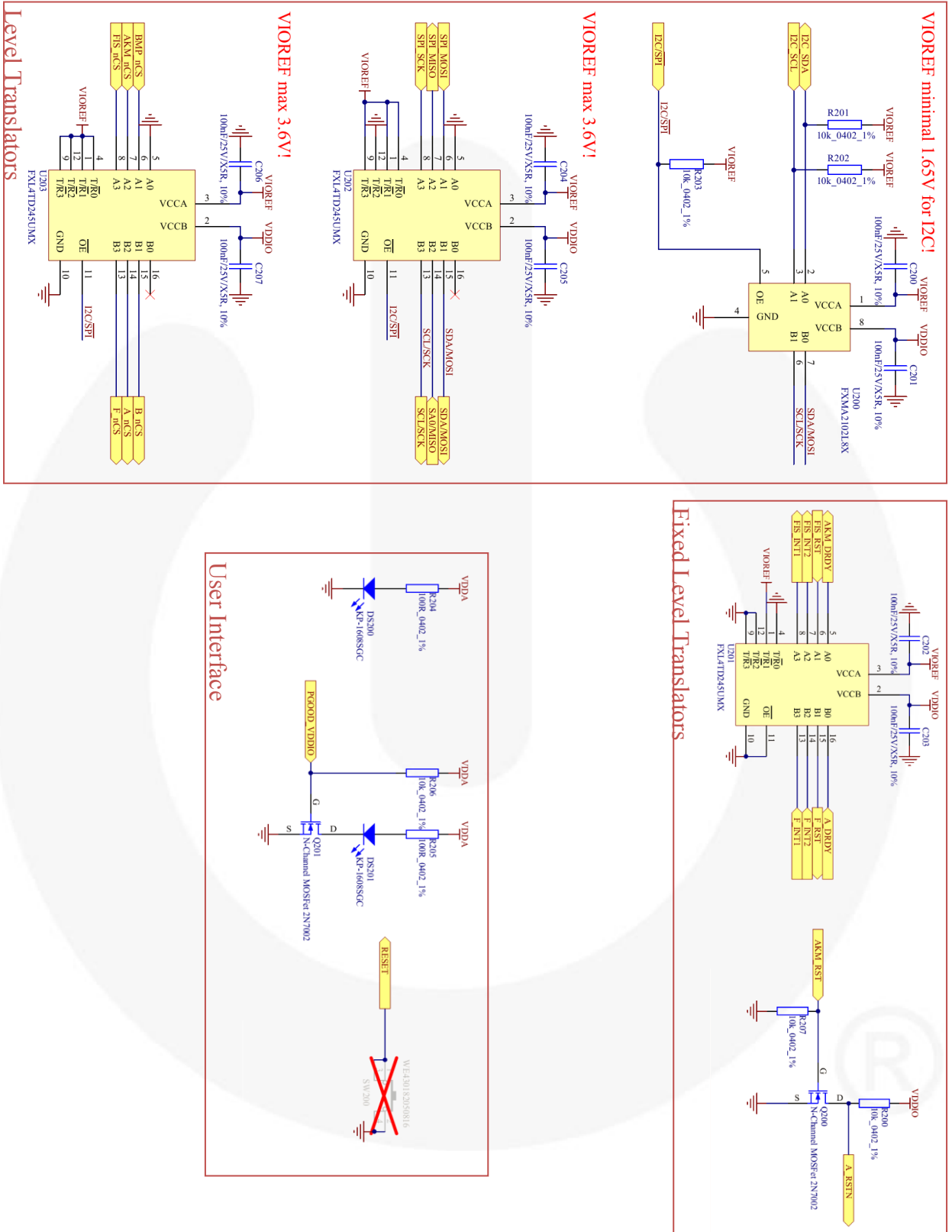
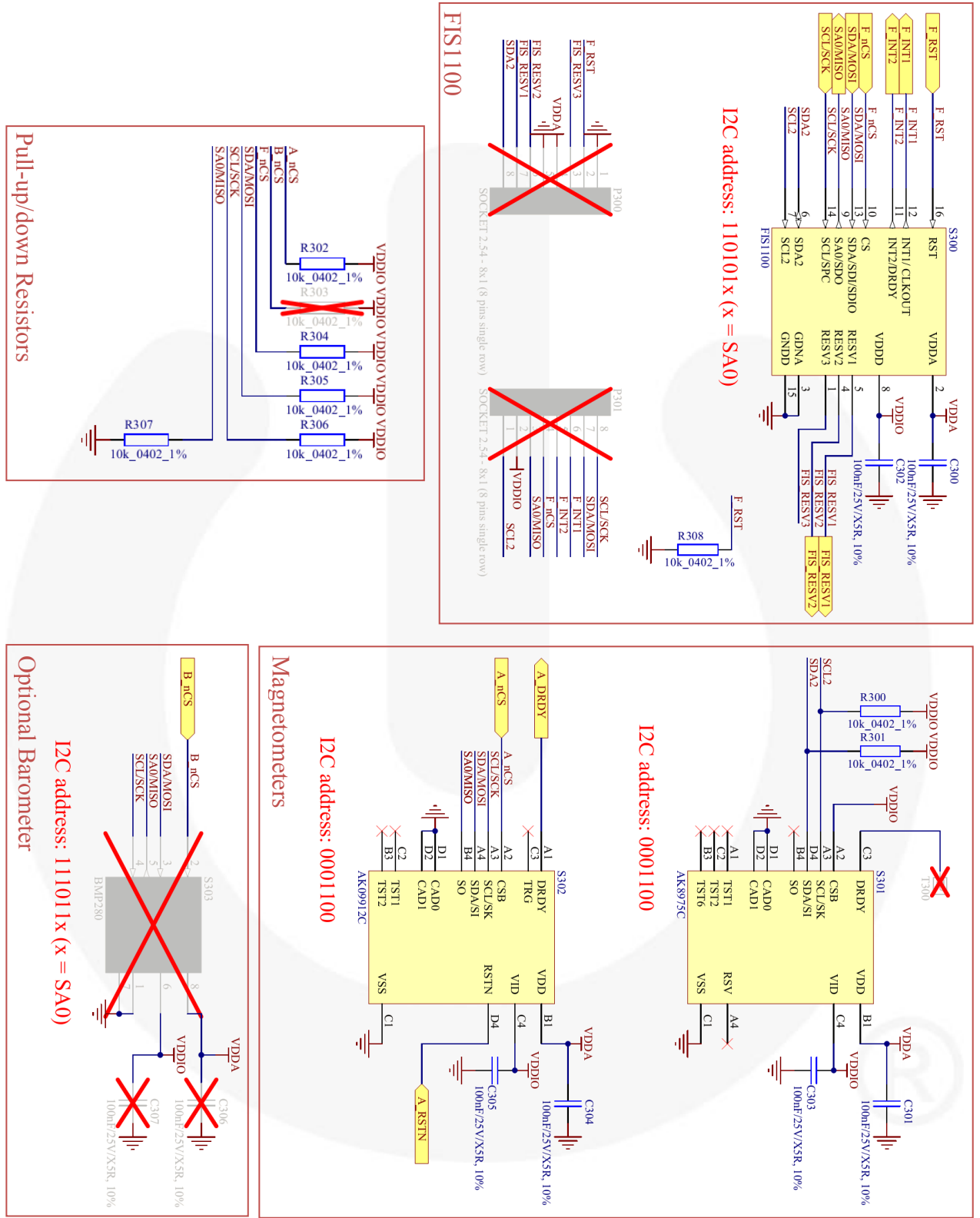

Figure 19. FEBFIS1100MEMS\_IMU6D3X Evaluation Board Schematic (Interfaces)





**Figure 20. FEBFIS1100MEMS\_IMU6D3X Evaluation Board Schematic (Sensors)**



## 7. Bill of Materials (BOM)

Reference	Qty.	Part Number	Value	Description	Manufacturer
C100, C101, C102, C103	4		4.7 $\mu$ F/10 V/X5R, 10%	4.7 $\mu$ F/10 V/X5R, 10%	
C200, C201, C202, C203, C204, C205, C206, C207, C300, C301, C302, C303, C304, C305	14		100 nF/25 V/X5R, 10%	100 nF/25 V/X5R, 10%	
DS200, DS201	2	KP-1608SGC	LED, 0603, GREEN	LED, 0603, Green	Kingbright
P100	1	SSQ-110-03-G-S	SOCKET DIGITAL_COM	10-pins Stackable Socket for Communication and digital IO	Samtec
P101	1	SSQ-108-03-G-S	SOCKET POWER	8-pins Stackable Socket for Power	Samtec
P102	1	SSQ-108-03-G-S	SOCKET DIGITAL_IO	8-pins Stackable Socket for Digital IO	Samtec
P103	1	SSQ-106-03-G-S	SOCKET ANALOG_IN	6-pins Stackable Socket for Analog Inputs	Samtec
Q200, Q201	2	2N7002	N-Channel MOSFET 2N7002	N-MOSFET 2N7002	Fairchild
R100, R102, R104, R106, R108, R112	6		0R_0402_1%	0R_0402_1%	
R109	1		143k_0402_1%	143k_0402_1%	
R110, R114	2		39k_0402_1%	39k_0402_1%	
R111, R200, R201, R202, R203, R206, R207, R300, R301, R302, R304, R305, R306, R307, R308	15		10k_0402_1%	10k_0402_1%	
R113	1		82k_0402_1%	82k_0402_1%	
R204, R205	2		100R_0402_1%	100R_0402_1%	
S300	1	FIS1100	FIS1100	FIS1100: Virtual 9 Degrees of Freedom (9 DOF) Attitude and Heading Reference System (AHRS)	Fairchild
S301	1	AK8975C	AK8975C	3-axis Electronic Compass	AKM
S302	1	AK09912C	AK09912C	3-axis Electronic Compass	AKM
U100, U101	2	FAN2558SX	FAN2558SX	180 mA Low Voltage CMOS LDO	Fairchild
U200	1	FXMA2102L8X	FXMA2102L8X	Dual-Supply, 2-Bit Voltage Translator for Open-Drain Applications	Fairchild

Continued on the following page...



### Bill of Materials (Continued)

Reference	Qty.	Part Number	Value	Description	Manufacturer
U201, U202, U203	3	FXL4TD245UMX	FXL4TD245UMX	Low-Voltage Dual-Supply 4-Bit Signal Translator with Independent Direction Controls	Fairchild
C306, C307	0		100 nF/25 V/X5R, 10%	100 nF/25 V/X5R, 10%	
J100, J101	0		HEADER 2.54 - 2x1 (2 pins single row)	Header 2 pins Single Row 2.54 mm Pitch	
P300, P301	0	SSQ-108-01-G-S	SOCKET 2.54 - 8x1 (8 pins single row)	8-pins Socket with 2.54 mm Pitch	Samtec
R101, R103, R105, R107	0		0R_0402_1%	0R_0402_1%	
R303	0		10k_0402_1%	10k_0402_1%	
S303	0			RESERVED	
SW200	0	430182050816	WE 430182050816	Tact Switch Ws-TSS	Wurth Elektronik

## 8. Testing MCU power consumption

The MCU development environment for the NXP LPCXpresso54102 board used by the FEBFIS1100MEMS\_IMU6D3X evaluation kit allows measuring the MCU power consumption. This allows the MCU power consumption and utilization to be evaluated with different configurations of FIS1100 outputs.

For details on performing power measurements please refer to the FIS1100 SDK HTML documentation included in the FIS1100 SDK installation.

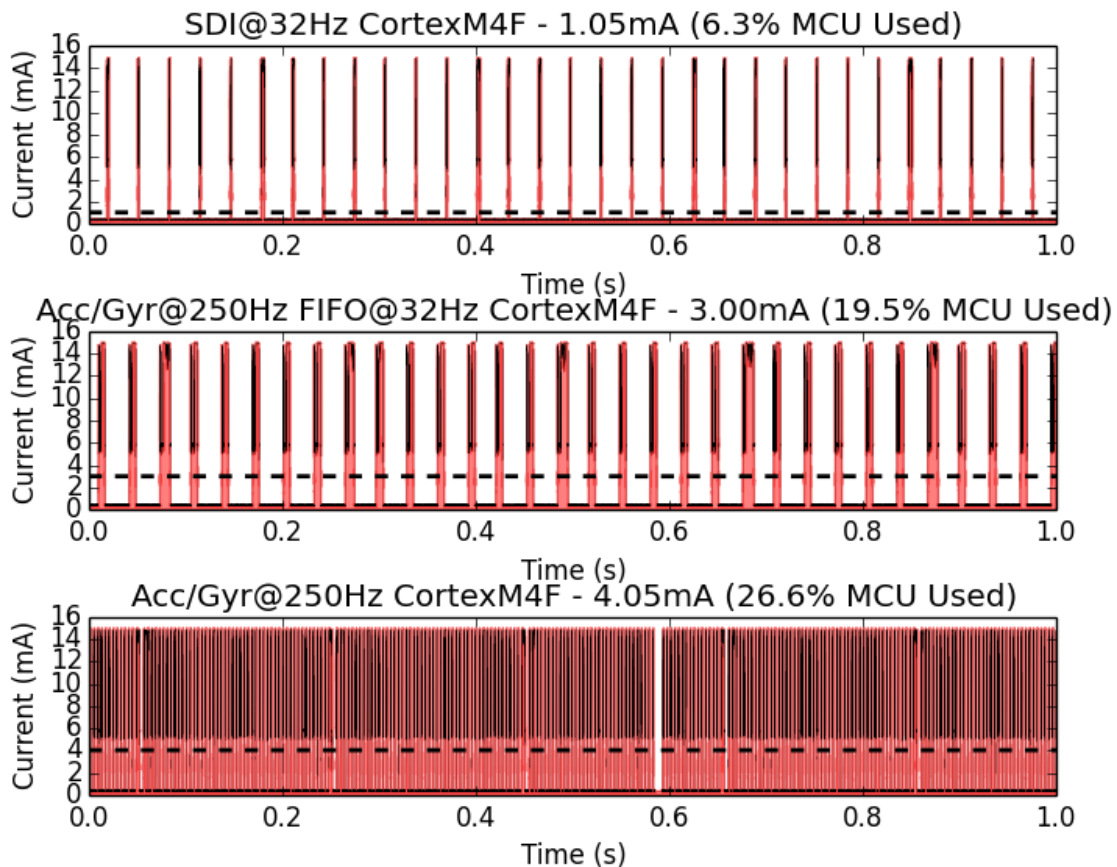

Figure 21. Power Consumption of the MCU Comparison example for FIS1100 Configurations using the AttitudeEngine (SDI) vs. the FIS1100 Configured to Output Raw Accelerometer and Gyroscope Samples



## 9. Revision History

Rev.	Date	Description
1.0.	April 2015	Initial Release

### WARNING AND DISCLAIMER

Replace components on the Evaluation Board only with those parts shown on the parts list (or Bill of Materials) in the Users' Guide. Contact an authorized Fairchild representative with any questions.

This board is intended to be used by certified professionals, in a lab environment, following proper safety procedures. Use at your own risk. The Evaluation board (or kit) is for demonstration purposes only and neither the Board nor this User's Guide constitute a sales contract or create any kind of warranty, whether express or implied, as to the applications or products involved. Fairchild warrants that its products meet Fairchild's published specifications, but does not guarantee that its products work in any specific application. Fairchild reserves the right to make changes without notice to any products described herein to improve reliability, function, or design. Either the applicable sales contract signed by Fairchild and Buyer or, if no contract exists, Fairchild's standard Terms and Conditions on the back of Fairchild invoices, govern the terms of sale of the products described herein.

#### DISCLAIMER

FAIRCHILD SEMICONDUCTOR RESERVES THE RIGHT TO MAKE CHANGES WITHOUT FURTHER NOTICE TO ANY PRODUCTS HEREIN TO IMPROVE RELIABILITY, FUNCTION, OR DESIGN. FAIRCHILD DOES NOT ASSUME ANY LIABILITY ARISING OUT OF THE APPLICATION OR USE OF ANY PRODUCT OR CIRCUIT DESCRIBED HEREIN; NEITHER DOES IT CONVEY ANY LICENSE UNDER ITS PATENT RIGHTS, NOR THE RIGHTS OF OTHERS.

#### LIFE SUPPORT POLICY

FAIRCHILD'S PRODUCTS ARE NOT AUTHORIZED FOR USE AS CRITICAL COMPONENTS IN LIFE SUPPORT DEVICES OR SYSTEMS WITHOUT THE EXPRESS WRITTEN APPROVAL OF THE PRESIDENT OF FAIRCHILD SEMICONDUCTOR CORPORATION.

As used herein:

1. Life support devices or systems are devices or systems which, (a) are intended for surgical implant into the body, or (b) support or sustain life, or (c) whose failure to perform when properly used in accordance with instructions for use provided in the labeling, can be reasonably expected to result in significant injury to the user.
2. A critical component is any component of a life support device or system whose failure to perform can be reasonably expected to cause the failure of the life support device or system, or to affect its safety or effectiveness.

### ANTI-COUNTERFEITING POLICY

Fairchild Semiconductor Corporation's Anti-Counterfeiting Policy. Fairchild's Anti-Counterfeiting Policy is also stated on our external website, [www.fairchildsemi.com](http://www.fairchildsemi.com), under Sales Support.

Counterfeiting of semiconductor parts is a growing problem in the industry. All manufacturers of semiconductor products are experiencing counterfeiting of their parts. Customers who inadvertently purchase counterfeit parts experience many problems such as loss of brand reputation, substandard performance, failed applications, and increased cost of production and manufacturing delays. Fairchild is taking strong measures to protect ourselves and our customers from the proliferation of counterfeit parts. Fairchild strongly encourages customers to purchase Fairchild parts either directly from Fairchild or from Authorized Fairchild Distributors who are listed by country on our web page cited above. Products customers buy either from Fairchild directly or from Authorized Fairchild Distributors are genuine parts, have full traceability, meet Fairchild's quality standards for handling and storage and provide access to Fairchild's full range of up-to-date technical and product information. Fairchild and our Authorized Distributors will stand behind all warranties and will appropriately address any warranty issues that may arise. Fairchild will not provide any warranty coverage or other assistance for parts bought from Unauthorized Sources. Fairchild is committed to combat this global problem and encourage our customers to do their part in stopping this practice by buying direct or from authorized distributors.

### EXPORT COMPLIANCE STATEMENT

These commodities, technology, or software were exported from the United States in accordance with the Export Administration Regulations for the ultimate destination listed on the commercial invoice. Diversion contrary to U.S. law is prohibited.

U.S. origin products and products made with U.S. origin technology are subject to U.S. Re-export laws. In the event of re-export, the user will be responsible to ensure the appropriate U.S. export regulations are followed.