

PCB terminal blocks, PCB connectors, panel feedthrough terminal blocks and electronics housings

Catalogue 2013

Let's connect.

OMNIMATE - device connectivity

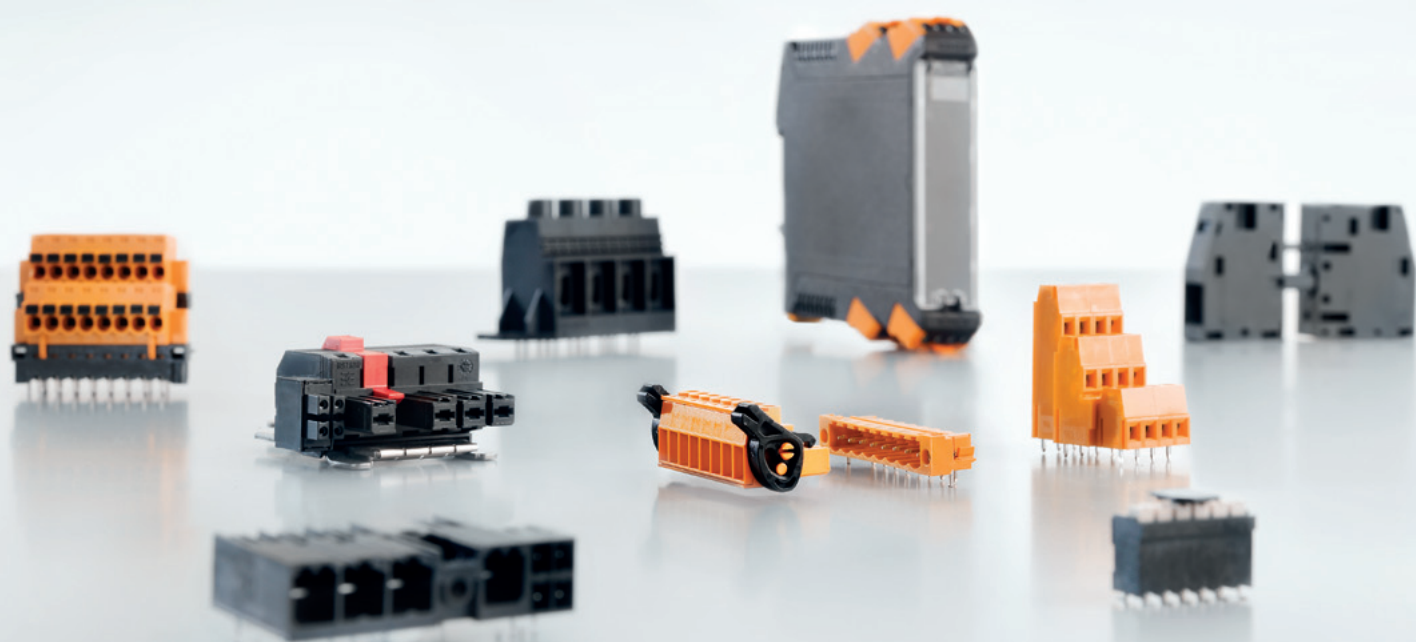

The World of Industrial Connectivity

As experienced experts we support our customers and partners around the world with products, solutions and services in the industrial environment of power, signal and data. Immerse yourself in our world of Industrial Connectivity. Let's connect.

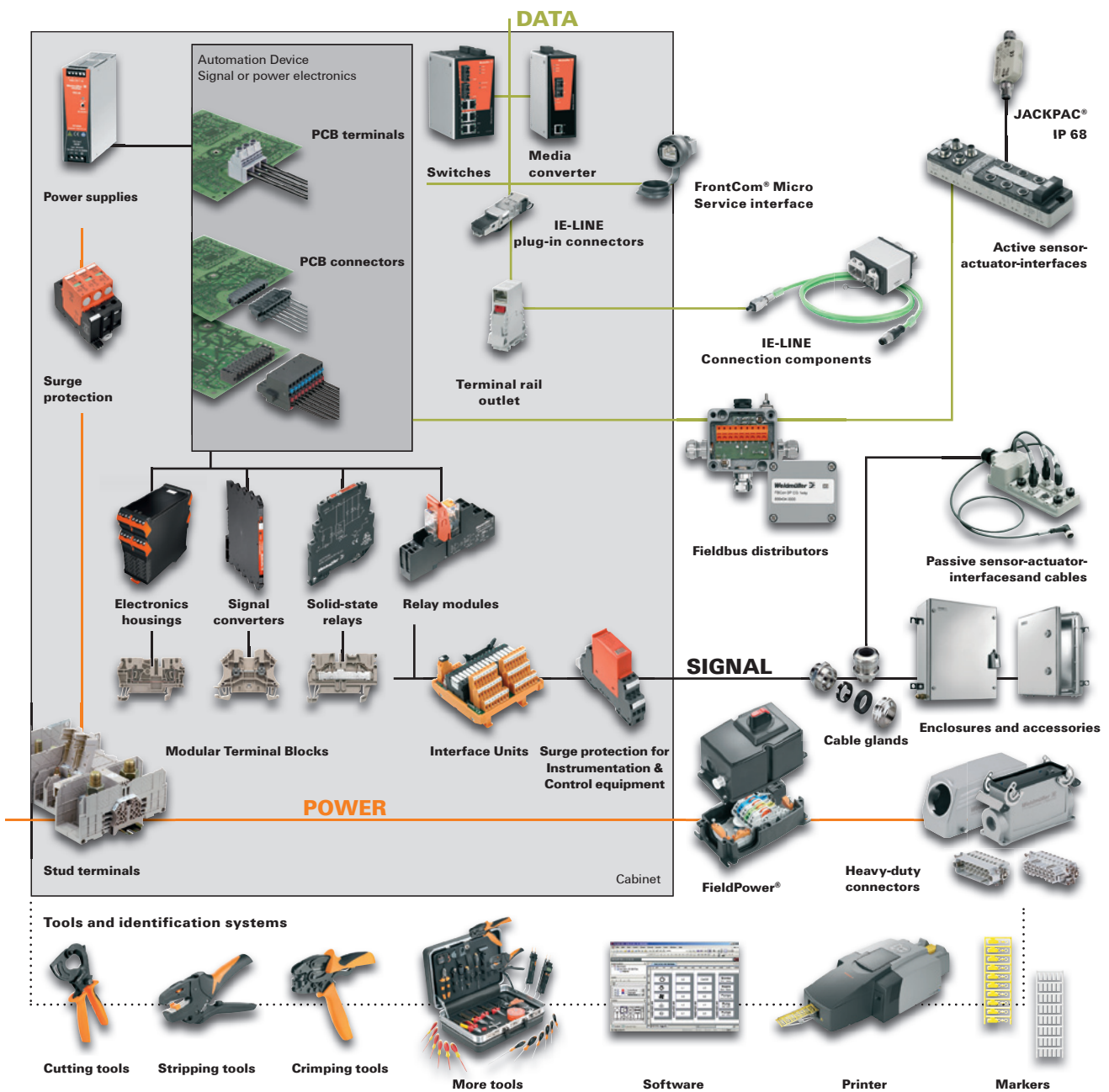

Dear Customers,

The PDF versions of our catalogues offer practical additional functions, helping you to find your way around our product range and simplifying the ordering process.

In addition to the catalogue, the PDF also contains:

- Internal page links
- Links to the online catalogue

Try it out for yourself. Click the order number to obtain more detailed information and close-up images via you web browser. The links in the PDF file also enable you to go directly to the next desired catalogue page.

Further Weidmüller product catalogues can be accessed by clicking the following:

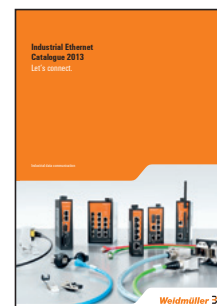
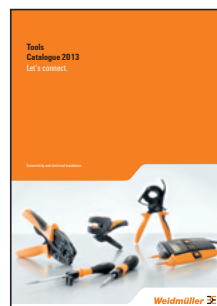
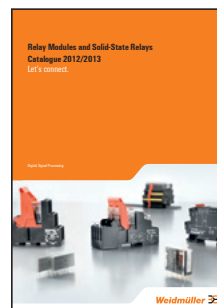

PCB terminal blocks, PCB connectors, panel feedthrough terminal blocks and electronics housings

Catalogue 2

PCB terminal blocks, PCB connectors,
panel feedthrough terminal blocks and
electronics housings

Introduction

OMNIMATE Signal

PCB terminals

PCB connectors

Accessories

OMNIMATE Power

PCB terminals

PCB connectors

Through-Panel Terminals

Accessories

OMNIMATE Housing

Housings for electronics

Accessories

Appendix

Technical appendix

Index

Search according to type or order number,
Addresses worldwide

OMNIMATE Signal – Overview

PCB terminals

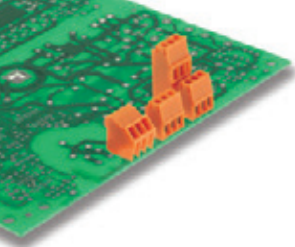
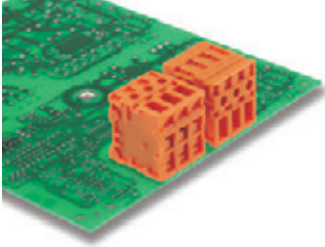
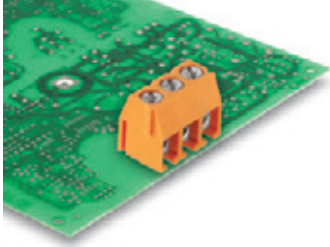
Chapter B	Clamping yoke screw connection LS, LM, LP and LL	TOP screw connection TOP1.5 and TOP4GS	Leaf spring screw connection PS and PM
			
Explanation	B.2	B.2	B.2
Quick selection	B.8	B.8	B.8
Technical data	B.10	B.46	B.54

PCB terminals

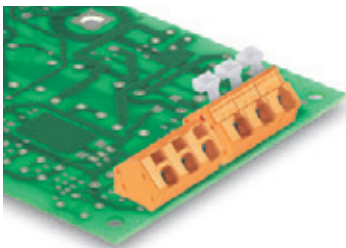
Chapter B	PUSH IN-spring connection LSF-SMT	Tension clamp connection LMZF and LMZF multi-level
		
Explanation	B.4	B.2
Quick selection	B.8	B.8
Technical data	B.58	B.96

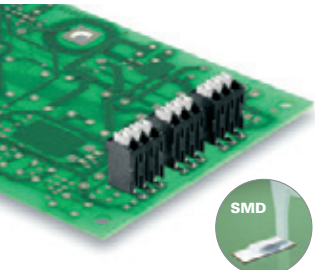

PCB terminals

Chapter B	PUSH IN-spring connection LSF-SMD
	
Explanation	B.6
Quick selection	B.8
Technical data	B.58

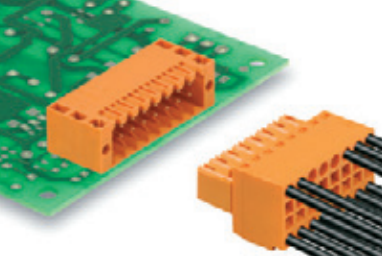
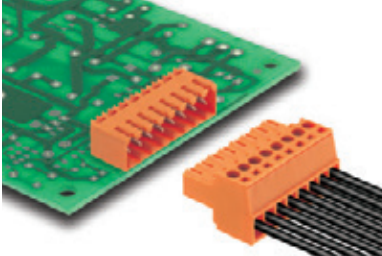
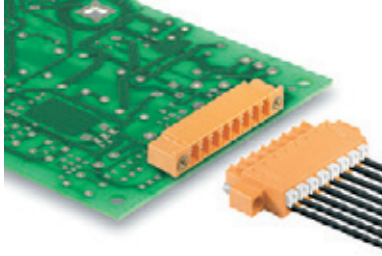
PCB connectors

Chapter C	2-row, Pitch 3.50 mm Series B2C / S2C 3.50	Pitch 3.50 mm Series BL / SL 3.50	Pitch 3.81 mm Series BC / SC 3.81	
				
	Connection	up to 1.00 mm ² / AWG 16	up to 1.50 mm ² / AWG 14	up to 1.50 mm ² / AWG 16
	Explanation	C.2	C.20	C.60
	Quick selection	C.4	C.24	C.64
Technical data	C.6	C.26	C.66	

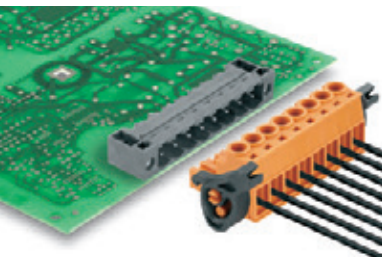
PCB connectors

Chapter C	Pitch 5.00 mm Series BL / SL 5.00	Pitch 5.08 mm Series BL / SL 5.08	Pitch 5.00 mm Series RSV	
				
	Connection	up to 4.00 mm ² / AWG 12	up to 4.00 mm ² / AWG 12	up to 2.50 mm ² / AWG 12
	Explanation	C.120	C.120	C.250
	Quick selection	C.132	C.162	C.252
Technical data	C.134	C.168	C.254	

OMNIMATE Signal - Accessories

Chapter D	Accessories	
	Technical data	from D.2

OMNIMATE Power – Overview

PCB terminals

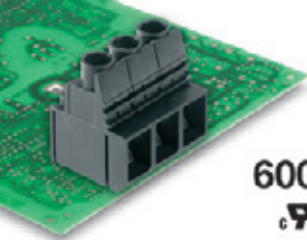
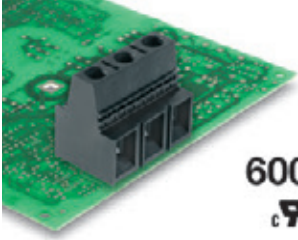
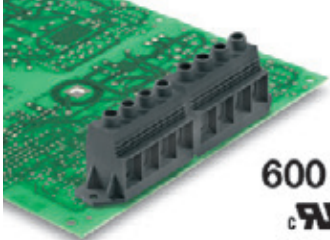
Chapter E	Pitch 10.16 – 12.7 mm Series LU / LUP	Pitch 15.00 mm Series LX	Pitch 15.00 mm Series LXXX
			
Connection	16 mm ²	25 mm ²	up to 50 mm ² / AWG 1
Explanation	E.2	E.2	E.2
Quick selection	E.4	E.4	E.4
Technical data	E.6	E.10	E.12

PCB connectors

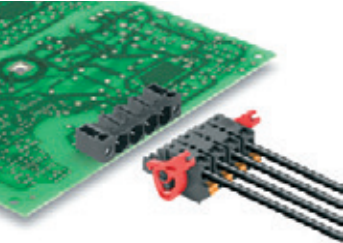
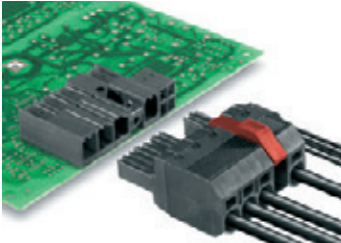
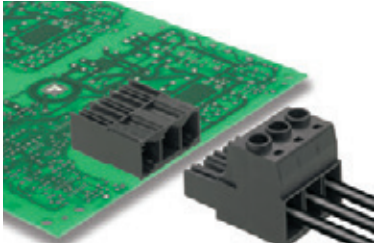
Chapter F	Pitch 7.62 mm Series BL / SL HP	Pitch 7.62 mm Series BV / SV HP	Pitch 10.16 mm Series BU / SU HP
			
Connection	up to 4.00 mm ² / AWG 12	up to 6.00 mm ² / AWG 10	up to 16.00 mm ² / AWG 6
Explanation	F.4	F.24	F.76
Quick selection	F.6	F.26	F.78
Technical data	F.8	F.28	F.80

PCB connectors

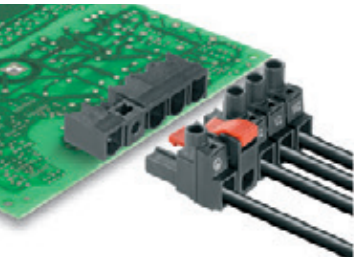
Chapter F	Pitch 7.62 - 10.16 mm Series IT
	
Connection	up to 16.00 mm ² / AWG 6
Explanation	F.92
Quick selection	F.94
Technical data	F.96

Through-Panel Terminals



<p>Chapter G</p>	<p>Series WGK</p> 
<p>Explanation</p>	<p>up to 95 mm² / AWG 4/0</p>
<p>Quick selection</p>	<p>G.2</p>
<p>Technical data</p>	<p>G.4</p>

OMNIMATE Power - Accessories



<p>Chapter H</p>	<p>Accessories</p> 
<p>Technical data</p>	<p>from H.2</p>

OMNIMATE Housing – Overview

Housings for electronics

Chapter I	OMNIMATE Housing 	Component housing CH20M 
Explanation	I.2	I.6
Orientation guide	I.4	I.15
Technical data		I.16

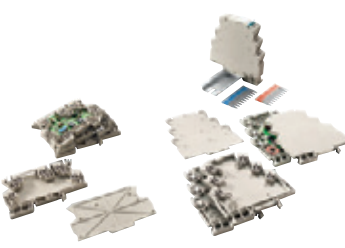
Housings for electronics

Chapter I	Terminal housing MHS, MHZ and MCZ 	Profile housing RS 
Explanation	I.36	I.40
Orientation guide		I.43
Technical data	I.38	I.44

OMNIMATE Housing – Accessories

Chapter J	Accessories 
Technical data	from J.2

Introduction

Introduction	OMNIMATE - Device connectivity and electronics housings Products, service and support	A.2
---------------------	--	-----

Introduction and overview of our basic portfolio

OMNIMATE – device connectivity and electronics housings from Weidmüller – take advantage of quality, efficiency and expertise for reliability and added value over the entire product lifespan.

Our wide, applications-based product line includes PCB terminals and connectors, feedthrough terminals, and electronics housings for industrial applications with an emphasis on signal processing and power electronics.

As a pioneering and leading provider of device connectivity, Weidmüller supports the entire design-in process with deep-rooted application expertise and proven know-how in finding solutions. Our global design-in support provides the perfect connection between products and services.

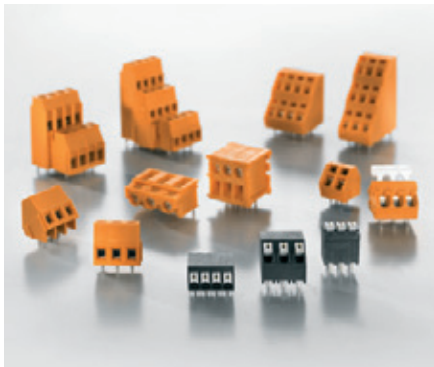

OMNIMATE Signal – PCB terminals

A simple and direct terminal connection to the circuit board: the terminal provides a high-density component assembly with good usability despite the compact dimensions. Typical applications are sensor-actuator interfaces and power supplies for the control and building industries. The main advantages:

- All standard connection systems, from clamping yoke to PUSH IN
- All-purpose usage with pitches from 3.50 to 10.00 mm
- Wide variety of reflow-compatible products
- Compact, multi-level construction



OMNIMATE Signal – PCB connectors

This convenient wire-insert method is the established standard in process and manufacturing automation as well as the measurement and control industries. The wide OMNIMATE line, with its six product series, provides design flexibility, efficient processing, and safe, intuitive handling. Additional advantages:

- Wire connections to meet market requirements: including a 0.5 mm² IDC bus, 1.5 mm² spring connection, and 4 mm² clamping yoke for two wires.
- A connection to the PCB that complies with SMT and wave soldering process.
- Compact, strong, all-purpose: 36 connections in 3.5 pitch; highest load capacity in 3.81 pitch; widest usage range in 5.08 pitch.



OMNIMATE Power – PCB terminals

The sturdy, direct connection for extreme current and voltage requirements in power electronics such as solar inverters, frequency converters and high-performance power supplies.

- High power: 150 A / 1000 V / 50 mm² (IEC) and 600 V / 127 A / AWG 1 (UL)
- Simple UL approval of the device up to 600 V
- Zero-maintenance steel clamp for screw connections that are resistant to vibration



OMNIMATE Power – PCB connectors

The pluggable connection method for modern drive systems and high-power electronics such as motor starters, inverters, servo drives and frequency converters. OMNIMATE Power sets the new standard – with increased safety and innovative solutions such as the pluggable shield, integrated signal contacts and one-handed operation.

- Applications-based scalability: ranging from the compact 4 mm² connection for 29 A, to the sturdy 16 mm² connection for 50 kVA (IEC).
- Unlimited usage up to 600 V (UL) or 1000 V (IEC)



OMNIMATE Power – WGK through panel terminals

The logical expansion of the portfolio to include direct through panel connectors for device panels. Excellent for applications such as EMC filters, discrete-built inverters for drive systems and encapsulated devices. A wide variety of applications made possible with:

- Wide power range for currents from 32 to 232 A and wire cross-sections from 4 to 95 mm² (AWG 4/0)
- Various types of connections: solder connection, cable-lug-stud connection, and clamping yoke screw connection.
- Options for accommodating horizontal or vertical wire outlets



OMNIMATE Housing – Electronics housings

The perfect platform for form and function: Weidmüller’s electronics housings provide a state-of-the-art platform for applications such as I/O sliced-design terminals, interface units, signal conditioners and power supplies. The portfolio covers all applications in the electrical cabinet, for example

- Component housing like the modular CH20M system for an individual design, efficient SMT processing and innovative use - scalable from 6 to 67 mm
- Profile cases for special designs and small batches with 6 widths in variable or modular configurations.



Individual services

The services described here are a perfect supplement to the basic portfolio – simple and quick to configure and tailor-made for your individual requirements. You can benefit from our decades of experience and innovative technologies.

In detail: your service portfolio

Customised colouring

Colour is a simple yet influential element of design. You can structure, integrate, design or label the connection area. With a wide selection of different colour schemes, customise our components to your application:



- Standard colours: black, orange, grey, green
- Signal and functional colours: blue, yellow, red

Clear labeling

Providing for smooth installation and quick repairs:



- A flexible layout for application-specific marking
- Including sharp-contoured special characters and symbols
- 4 methods: pad printing, laser printing, inkjet labels and adhesive systems

Process-compatible packaging

The proper packaging for your manufacturing process raises efficiency. You can choose between:



- Box (standard): space saving and environmentally friendly
- Tape on reel: A specific roll for each feeder from 24 mm
- Tube: can be automatically assembled, even without a feeder
- Tray: even large components can be quickly reached

The aim: your tailored solution

Weidmüller's products and services are designed with one goal in mind: optimisation. No more, and no less than this.

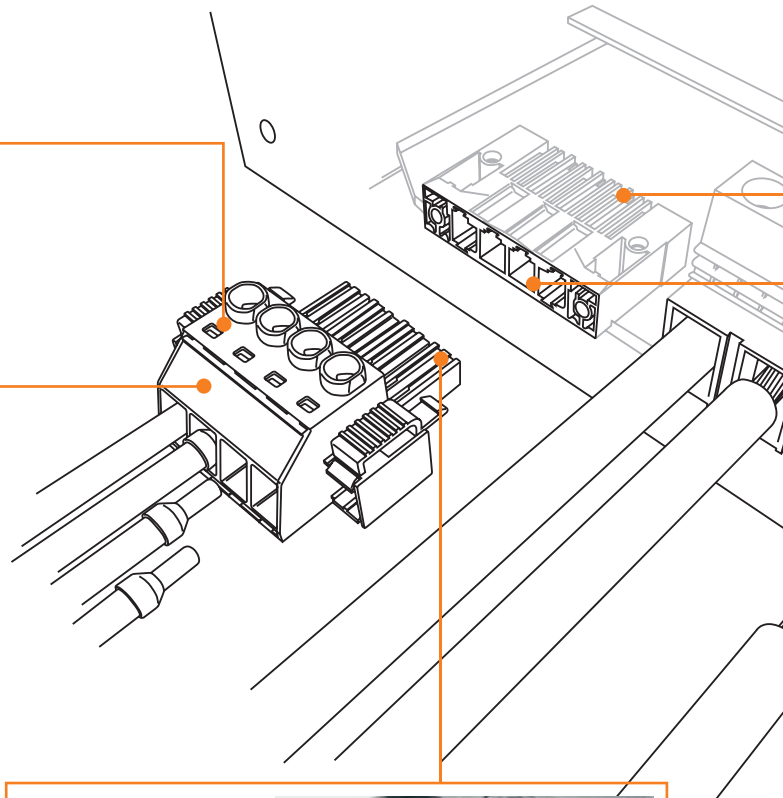

Distinctive coding

So that only those components which belong together fit together. Take advantage of our systematic connector or PCB coding systems:



- Versatile: individual manual coding in the process or on-site
- Practical: pre-assembled coding from the factory, per your requirements
- Efficient: pre-formed coding with large quantities

<http://galaxy.weidmueller.com>

Weidmüller’s design-in partnership – more than just contacts.

- More design freedom, clearer differentiation, greater degree of innovation
- Less overhead, less compromises, a shorter time to market
- Consistently reliable, maintenance-free, secure connections

The result: satisfied customers, greater success.

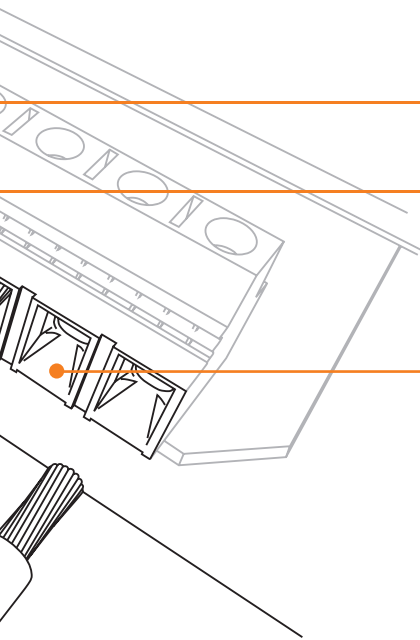

Pin lengths optimised for the process



Choose the ideal pin length based on engineering requirements and process parameters, including:

- Circuit board construction: thickness, assembly type
- Assembly process: manual or automatic
- Soldering process: wave or reflow soldering

Application-oriented contact platings

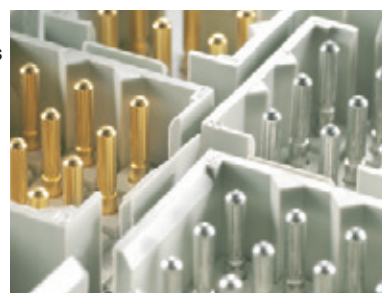

Specify the proper contact platings – based on the electrical parameters and dependent on:

- Environmental conditions such as moisture level
- Mechanical factors such as vibration
- Application characteristics such as the number of plugging cycles
- Thermal influences such as temperature values and cycles

Selective assembly

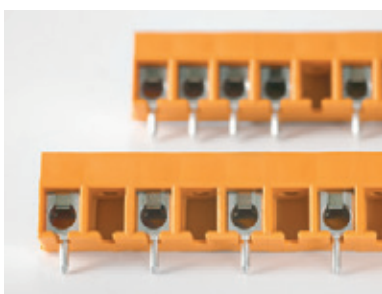

Extend the clearance and creepage distances – partial assembly is simple and:

- Space saving: smaller dimensions than a large pitch
- Efficient: different voltage ranges in one component
- Economical: possible to use lower performance classes

Application-specific development



Seamlessly proceeding with your custom configuration: In addition to our technical and production expertise, Weidmüller’s principle of “pro-active design-in” ensures that your solution will always be integrated into your project and application.

Unending support: Partnership Powered by Weidmüller

Adapted to your design-in needs, we have a variety of useful tools available on the Internet so that you can find the right OMNIMATE components for your needs.



How can I find the right product for my application?

Take advantage of the basic selection in our product configurator. This online assistant gives you expert support, along with all of the engineering data. <http://galaxy.weidmueller.com>

Key in your design data, select your components and ask about the features: number of poles, terminal pin length, colour, contact surface and packaging. All in a single click.

Detail configuration for reliable field application.

If the basic configuration is not sufficient, you can build the product that fits your needs using the configurator. You can also have coding - some with assembly and inscription, with the option of printing techniques, colours and letter/symbol orientation. Just pick your product and send it in a query to Weidmüller.



Are you looking for product data?

You will find all of the documents in the online catalogue including data sheets, drawings, related products and 3-D models, all in a common format and with direct access to the product. For viewing, printing out, downloading and email.



Reference sample from our warehouse.

Do you need initial samples for your prototypes? Just order your design-in samples, quickly and easily. With the OMNIMATE® Sample Service for Weidmüller connection components and electronic housings, you can find your design-in sample online and get it delivered anywhere you want, within 72 hours. Select from more than 2,500 product models of our OMNIMATE® power, signal and housing solutions. You can check the application suitability of the ordered components in only 72 hours.

We have help and advice on hand: proactive design-in

A helpful and reliable team: online resources plus „human resources“ in the form of web assistants and your own personal contact person.

You profit from:

- constructive customer relations
- a high level of applications expertise
- an unflagging search for solutions



We're only satisfied when you are. That's why our effort doesn't stop at delivery. We are pleased to support you in coming up with solutions to your challenges - from market roll-out all the way to special customer requirements.

Six simple steps to reach your goal with twice the efficiency: your customised solution with service plus support.

Take advantage of our service and support combination for optimising your design-in process – from the specification stage to component integration.

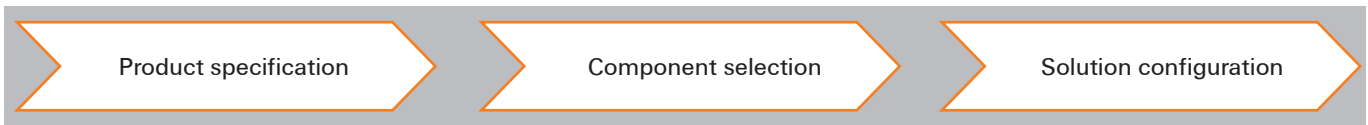

**Your starting point:
our comprehensive standard portfolio**

The market standard for quality, efficiency and innovation – this is our contribution towards your success.



**Your options to upgrade:
the complete accessory portfolio**

Supplement your basic components with additional functions.



**Freedom of design:
our versatile services portfolio**

Make your selection a part of your application – by selecting the design, function, construction and process.

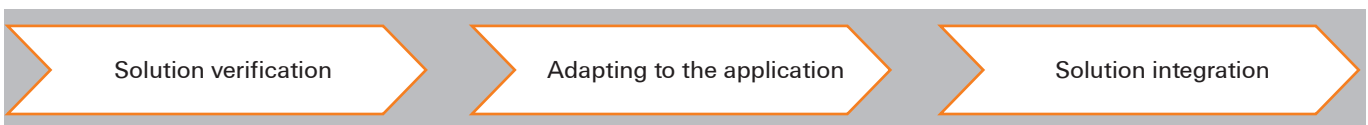

**The basis for decision:
the TARGET-balance**

From concept, via model to the prototype: supplement our CAD support and verify your design with our prototype service.

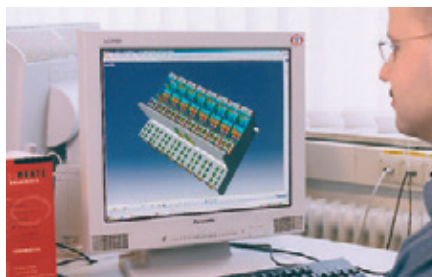

**Tailor made:
with individual development**

Do you need more than a standard configuration? We will put our heads together to come up with your custom solution, for your individual requirements.



**The result:
an exact solution**

Whether it's a configuration or modification – take advantage of our services – to make sure your customer comes back - not your equipment.

<http://galaxy.weidmueller.com>

Connection system

Clamping yoke screw connection

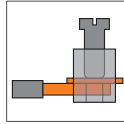

The clamping-yoke connection is the most used screw connection in the world. Steel clamping-yokes made of using a stamping and bending process guarantee a vibration proof clamp connection. When the screw on the clamp is tightened, there is a counter effect in the clamping yoke's threaded area which prevents the connection accidentally loosening. As the screw thread is on an inclined plane, there is a force gain created and a very high clamping force is achieved. Weidmüller uses hardened steel with optimal corrosion protection for stability and security and copper alloys in the contact area for good electrical conductivity.

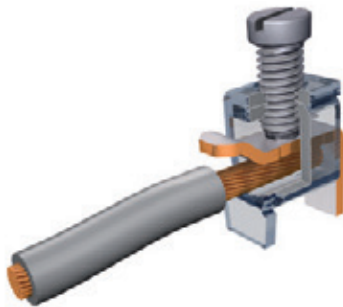

Customer benefits:

- The screw connection guarantees a globally accepted, vibration proof and maintenance free connection.
- A large conductor clamping area is covered.
- The "Wire Ready" technology ensures that the terminal points are fully open at delivery, even after being transported world-wide
- The "Wire Guard" protection mechanism prevents accidental insertion of the wire underneath the clamping area which can be dangerous, it protects against hidden faulty contacts
- The flat clamping yoke also enables the clamping of very small cross-section wires

Field of application:

The standard connection for applications in industrial environments with the highest requirements for reliability even under harsh conditions.

PUSH IN spring connection

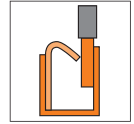

The PUSH IN spring connection with direct plug-in technology allows the fastest wiring process: the stripped or prepared wire is simply pushed into the terminal point as far as it will go and the connection is finished. Operating the release lever is only required with flexible wires or to release the connection. The stainless steel spring ensures a high contact force between wire and the tinned copper busbar. A stainless steel cage enclosure prevents subsidence in the contact area. To prevent any drop in clamping force plastic parts were deliberately not used.

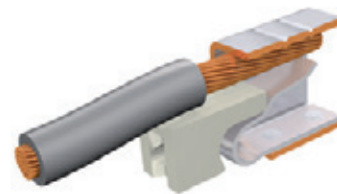

Customer benefits:

- Fast, tool-less wire connection with direct insertion technology
- The stainless steel spring results in a vibration-resistant connection
- Higher resistance to wire pull-out than in a tension clamp system
- Constant conductor clamping force independent of the operator
- Operator error is reduced using a colour-coded and intuitive actuator
- Wire feed and the operation are aligned in the same direction which permits a compact equipment design

Field of application:

The default choice for operation in the field; it permits speedy wiring and, combined with its small size, its intuitive use is also advantageous even in environments with severe vibration.

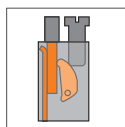

TOP screw connection terminal with Pull-Effect

In the traditional case, the screw is always at a right angle to the conductor outlet direction. The TOP connection, however, allows wire insertion and the screw orientation in the same direction. The TOP connection produces the greatest possible packing density in the terminal area. The "pull effect" ensures that the connected wire is pulled in to the clamping point producing a secure contact.

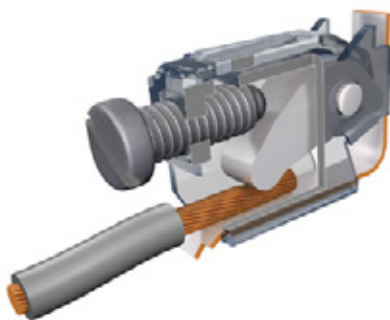

Customer benefits:

- The "pull effect" pulls the wire into the terminal point. Problems with clearance and creepage distances are avoided.
- Wire feed and the operation are aligned in the same direction which permits a compact equipment design
- The minimum installation height results in an extremely high packing density

Field of application:

Housing design or installation requirements such as PCB slots, that do not allow a right angled screw operation for reasons of space.

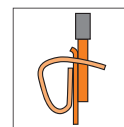

Tension clamp connection

The pre-tensioned tension clamp is made from high quality rust and acid resistant steel, which pulls the wire against the galvanised copper busbar. This results in a permanent and vibration resistant connection. Operation is simple; the spring is opened with a screwdriver, wire is fed through the wire guide into the spring cage and the screwdriver is removed resulting in a clamped wire. The surface-treated busbar ensures low contact resistance and a high resistance to corrosion.

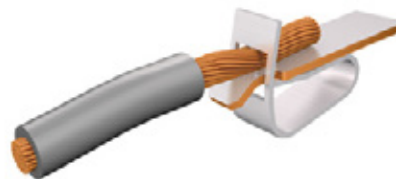

Customer benefits:

- Constant conductor clamping force independent of the operator
- Wide-spread connection technology
- Simple operation using a screwdriver or the integrated release lever

Field of application:

Fast wiring with a constant clamping force, even in environments with severe vibration.

Connection system

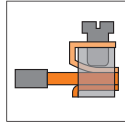

Leaf spring screw connection

The leaf spring screw connection is the oldest method on the market for connecting a conductor. The leaf spring prevents damage to the conductor when the clamp screw is tightened. The leaf spring is a simplified connection yet suited for the requirements of building automation connection technology.



Customer benefits:

- Cost effective alternative to the clamping-yoke connection
- A particularly simple connection solution suited to less demanding environmental conditions.
- High power density in a small footprint

Field of application:

Applications with less demanding environmental conditions and narrow installation space.



Crimp connection

The crimp connection method provides an affordable solution with pre-assembled female plugs that is also appropriate for large batch jobs. The crimp contacts can be attached using hand tools or with a crimping machine for producing large batches. The contacts are then locked into the housing provided. For fully automated processing, taped crimp contacts are available.



Customer benefits:

- Rapid, fully automated pre-assembly of connectors is possible
- Long-lasting, positive connection methods
- Minimal contact resistances
- The conductor connection is extremely thermal shock and vibration resistant

Field of application:

Applications that combine fully automatic and factory oriented processing steps with the actual field wiring. Works in environments with severe vibration or temperature fluctuations.



THR soldered connection

Reflow products in THT (through-hole technology) are the best alternative to using just SMT (surface-mount technology) if higher forces might be operating on the printed-circuit board components. The component design of Weidmüller products is specifically developed for this application and takes into account the requirements in terms of structural shape, temperature stability and processing for THT products from the word „go“.

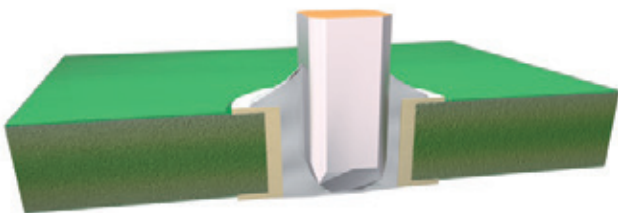

Customer benefits:

- Special temperature-resistant plastics with a melting point of over 300 °C.
- 2 pin lengths – 1.5 mm for low paste requirements and 3.2 mm for focus on quality assurance.
- Packed in standard cardboard boxes or antistatic belts, for use in pick-and-place machines.
- Comparably higher current-carrying capacity due to the plastic's high temperature stability.

Field of application:

Applications where fast processing and reliable and stable connections to the printed-circuit board are of the essence. Reflow, wave or hand soldering with high temperature requirements.



SMD surface soldering connection

Electronic subassemblies are manufactured economically using surface-mount technology (SMT) with surface-mount devices (SMD). Design measures such as co-planarity and the size/shape of the soldering pads lend electromechanical components a reliable and stable printed-circuit board connection. The structural shape and temperature stability of Weidmüller SMD components are matched to processing in automated surface mounting equipment.

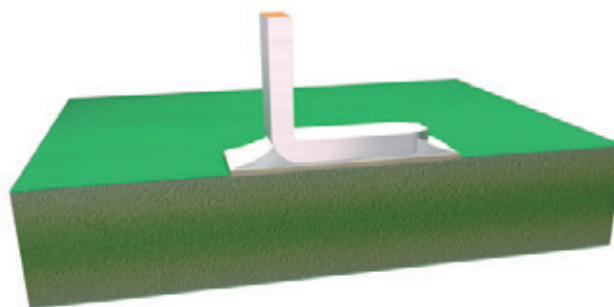

Customer benefits:

- In contrast to THR, no holes are necessary for printed-circuit boards (for instance, with glass ceramic-printed circuit boards).
- Two soldering pads per connecting point boost mechanical stability.
- Standard packaging in the antistatic belt means it can be used in pick-and-place machines.
- High dimensional stability due to plastic with a high level of temperature resistance, with a melting point over 300 °C.

Field of application:

Subassemblies that are exclusively equipped with SMD components and exposed to medium electromechanical loads.

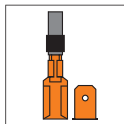

Flat-blade connection

Flat blade connections are a widespread connection method in accordance with DIN 46247. This technology connects pre-assembled, insulated and non-insulated cable-lug sleeves by simply insertion of the cable-lug connector on a standard terminal block.



Customer benefits:

- Fully automated, pre-assembled wire bundles are possible
- Can be used with 2.8 and 6.3 mm flat blade receptacles
- Suitable for insulated and uninsulated versions.

Field of application:



Suitable for applications where pre-assembled cables need to be fitted quickly to the PCB.

Fastening options for OMNIMATE printed-circuit board plug-and-socket connectors

<http://www.OMNIMATE.net>

Flange options for plug-and-socket connectors

- = recommended
- = possible to a limited extent

		O	G	B	F / FI	LF/LFI/FLF	RF	MF/MSF				
		open	closed	dovetail for B block	flange with nut	flange with nut	locking flange without a nut (for release latch)	centre flange with/without nut				
fastening for the printed-circuit board		no	no	with the nut from accessories	optional screw	terminal pin	terminal pin	terminal pin (partially)				
		pin headers										
												
		socket terminal strips										
												
OMNIMATE signal and power	G	closed	no			●	●	●	●	●	●	
	B	dovetail for B block	via accessories with a screw			●	●	●	●	●		
	F	flange	screw			●	●	●	●			
	FI	inverted flange	nut			●	●	●	●			
	LH	release gear	no			●	●	●	●	●		
	LR	release latch	bar			●	●	●	●	●		
OMNIMATE Power	F	flange	locking hook					●				
	FI/SFI	inverted flange	locking hook/with screw					●	●			
	MF/MSF	centre flange	locking hook/with screw								●	

OMNIMATE Signal PCB terminals

OMNIMATE Signal PCB terminals	Explanation	B.2
	Quick selection	B.8
	Clamping yoke screw connection	B.10
	TOP screw connection	B.46
	Leaf spring screw connection	B.54
	PUSH IN spring connection	B.58
	Tension clamp connection	B.96

OMNIMATE Signal PCB terminals

Flexible and versatile available in pitches from 3.5 to 9.52 mm

B

A wide variety of application requirements from the industrial automation and control fields are solved using the components from the comprehensive OMNIMATE Signal PCB terminal range.

You can find a suitable solution for almost any application, whether in terms of the conductor outlet direction, the pitch, the wire cross-section to be clamped, the required contact density through multi-level varieties or the sort of connection you want.

Standard-compliant integration

Following relevant international guidelines/standards and Weidmüller's laboratory accreditation ensure highest quality standards for use globally.



Screw connection system

The automatically counter-operating Weidmüller steel clamping yoke uses force generated by tightening the screw to open the upper thread. Settling of the connected wires and vibrations are compensated for and this guarantees a maintenance free operation. Subsequent tightening and maintenance of the screw is not needed.

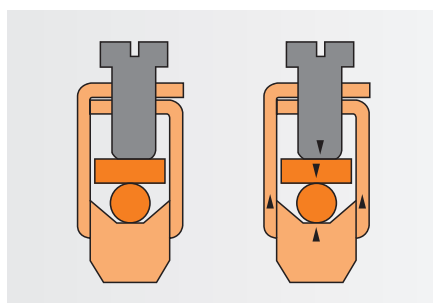

Fire resistance

The high-quality plastics used in many of the product families in the OMNIMATE Signal product line meet the higher fire safety requirements according to the domestic appliance standard IEC 60335-1.

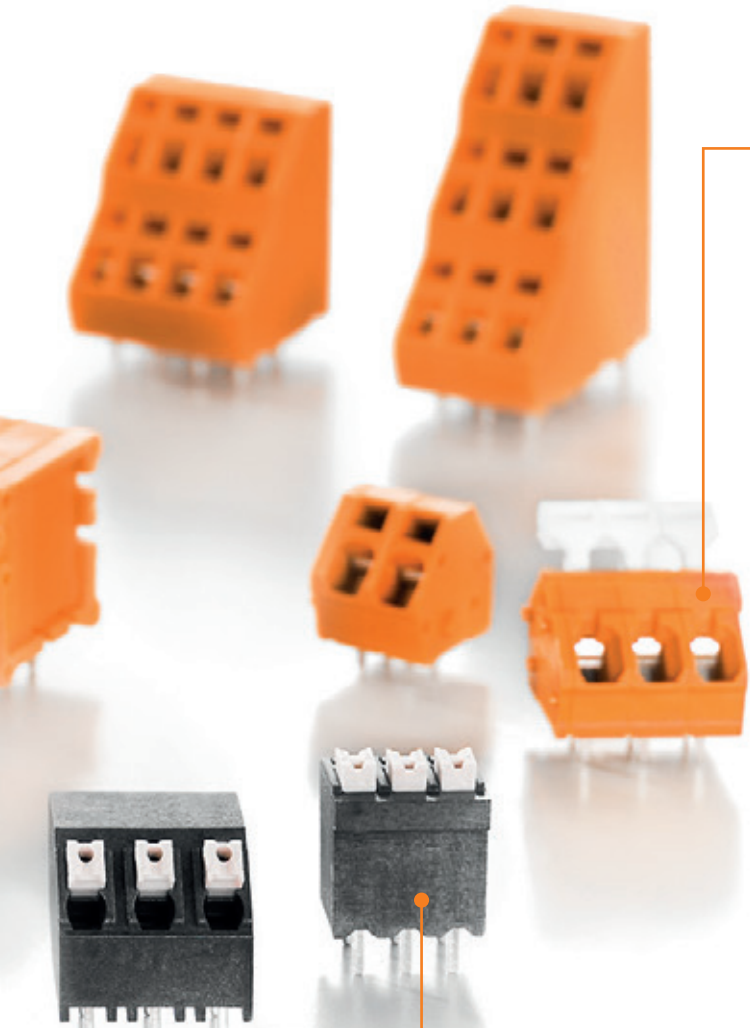

Tension clamp connection system

Simple and fast - the universal screw-less connector with a steel spring. Ideal for PCB installation terminals where it is important that the connections are secure. Single row, with or without an operating lever to open the terminal point with a wire cross-section of up to 2.5 mm². Higher connector density with double, or triple level variations with a pitch of 5.08 mm and clamping range of up to 2,5 mm².

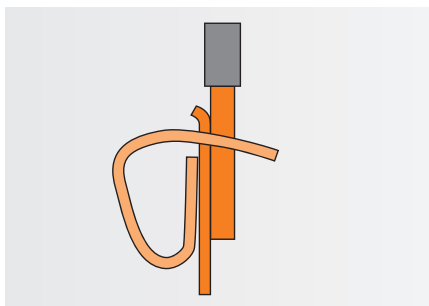

PUSH IN connection system

The innovative quick connector – simple, safe and economical. Direct insertion of solid-core wires and stranded wires with ferrules when used with the LSF-SMT series.

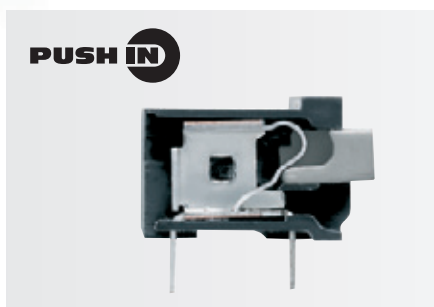

Power reserve for safety

The high performance insulating material WEMID with a continuous operating temperature of 120 °C for higher load currents and ambient temperatures. OMNIMATE Signal PCB terminals already exceed the standard PA working temperature (100 °C) of many product families by 20 °K. This allows more power reserves and increased safety during temperature fluctuations or overloads.

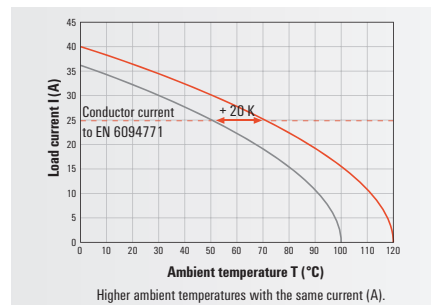

OMNIMATE Signal PUSH IN PCB terminals

Spring connection LSF-SMT is available in pitches from 3.5 to 7.62 mm

B

The innovative quick connector - simple, safe and economical.

Its compact dimensions and surprising performance of 17.5 A / 800 V (IEC) means that the LSF-SMT meets the market push for miniaturisation. The OMNIMATE Signal PCB terminals LSF-SMT offer a wide pitch range from 3.5 to 7.62 mm, in various conductor outlet directions (90°/135°/180°) to the PCB for connections of wire cross-sections of up to 1.5 mm². The use of high-quality materials guarantees maximum cost effectiveness in the manufacturing of electronic assemblies.

Form stability for the reflow soldering process

The high-temperature-resistant insulating material LCP used in the LSF-SMT range, is characterised by its form and dimensional stability. Due to low moisture absorption, the LSF-SMT can be immediately used in the Reflow THR soldering process without an extra drying phase. The uninterrupted production process from automated assembly to soldering is achieved saving you time and money.

SMT/THR process compatible

The compact design and packaging (tape-on-reel) for automatic pick and place systems of SMT production lines reduces production costs of electronic components even further.



Flexible processing

With a pin length of 3.5 mm for hand and wave soldering, or 1.5 mm for reflow soldering (THR), there are standard models available even for double sided assembled PCBs.

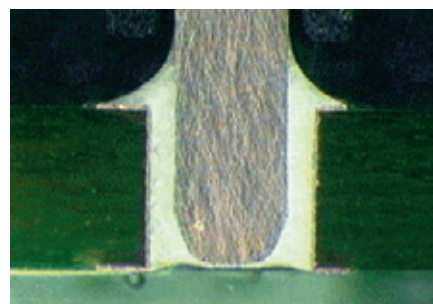

Fire resistance

The high-quality plastics used meet the higher fire safety requirements according to the domestic appliance standard IEC 60335-1.



Design flexibility

With the conductor outlet directions of 90°/135° and 180° over all pitches from 3.5 to 7.62 mm, all design options are possible.

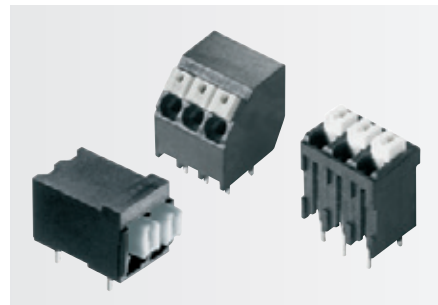

Marking and mapping

Terminal points can be distinctively marked with coloured push buttons or individual printing.



Safe and efficient

Solid conductors or wires with ferrules up to 1.5 mm² can be connected with the rapid spring-connection technology PUSH IN. The integrated push buttons are used for releasing. Amazingly simple and simply amazing in practice.

PUSH IN

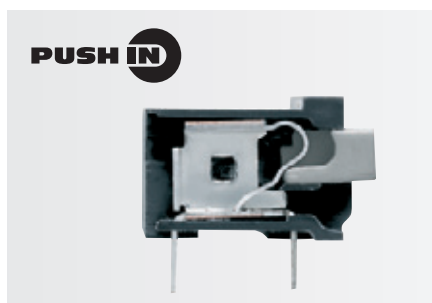

OMNIMATE Signal – LSF-SMD 3.5/180 „PUSH IN“-PCB terminals for SMD assembly



B

The new LSF-SMD meets the demands for fully automatic PCB assembling as a surface-mounting device (SMD). Two SMD solder pads per pole ensures a high mechanical stability. It is now possible for applications on glass based, ceramic based and aluminium compound based PCB 's to also take advantage of "PUSH IN" technology.

The existing portfolio of Weidmüller's reflow compatible LSF-SMT terminals with THR soldering has been expanded to include a real SMD variant.

The 3.5 mm pitch and the wire outlet direction of 180° allow a high packing density with a maximum wire cross section of 1.5 mm².

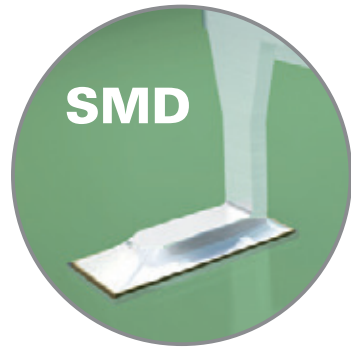

Order a sample

Let yourself be convinced by the LSF-SMD features. Request a free sample using.



Reliable processing

The LCP causes no formation of blisters and no predrying is required (MSL 1). Direct assembly with the SMT process is possible.

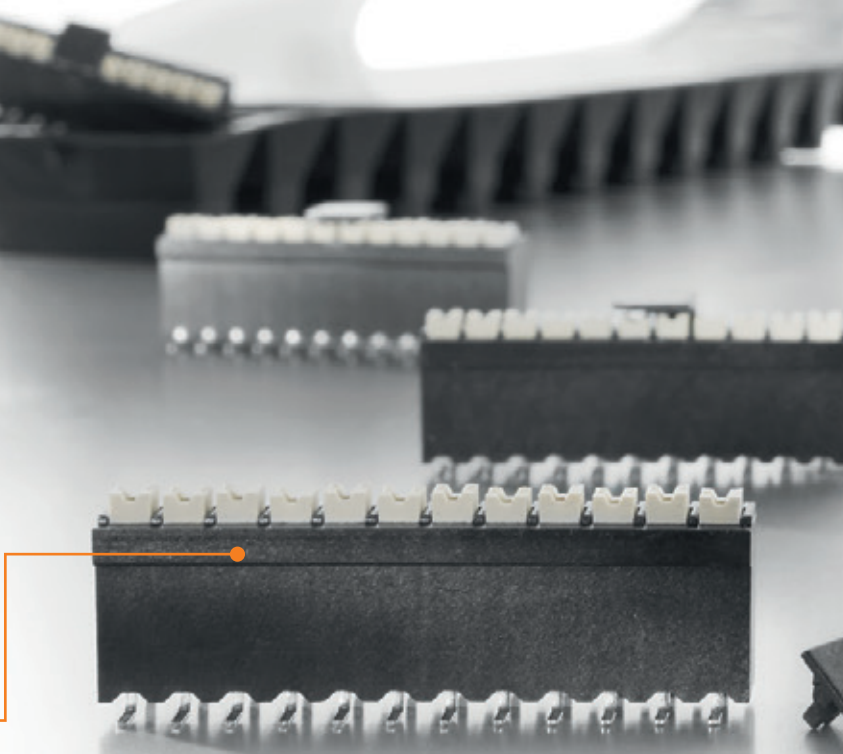
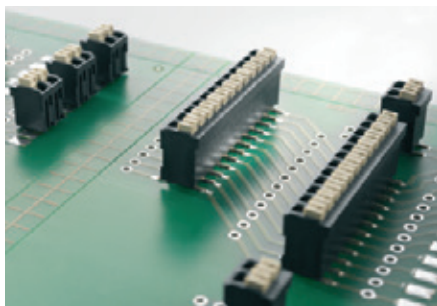

Stable soldering connections

With two solder pins per pole, the LSF-SMD PCB terminal is adequately attached to the circuit board and does not need an additional mounting flange.

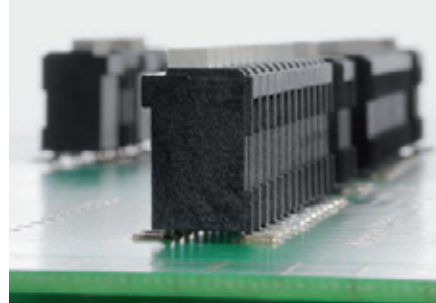

Efficient assembly

An efficient automatic assembly process is supported by the tape on reel packaging in standard tape widths. The optimised Pick and Place pads ensure that the pick and place process is safe and reliable.



Fast wire connection method

Safe contact connections up to 1.5 mm² with no tools needed: made possible by the proven "PUSH IN" connection system. The integrated release button is used to disconnect the cable in a simple and quick manner.

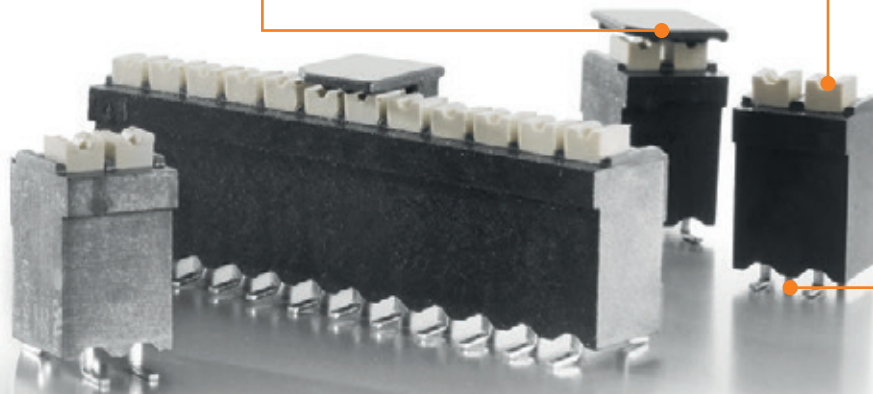
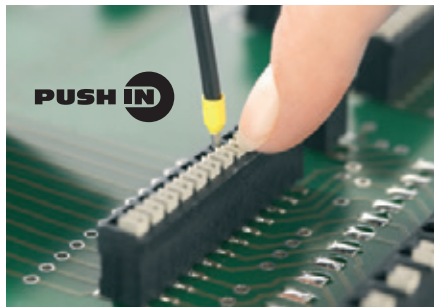

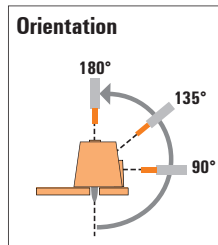

<http://www.OMNIMATE.net>

PCB terminals

Type of connection	Clamping range	Type	IEC / UL	90°	135°	180°	
Screw	Clamping yoke ≤ 1.5 mm ²	LM	IEC: 320 V/16 A/0.5 - 1.5 mm ² UL: 300 V/10 A/AWG 28 - 14	●	●		
		LS	IEC: 630 V/17.5 A/0.08 - 1.5 mm ² UL: 300 V/15 A/AWG 28 - 14	●			
	≤ 2.5 mm ²	LM	IEC: 630 V/17.5 A/0.2 - 2.5 mm ² UL: 300 V/15 A/AWG 24 - 14	●	●	●	
		LP	IEC: 500 V/32 A/0.5 - 6 mm ² UL: 300 V/20 A/AWG 26 - 12	●	●	●	
	≤ 6.0 mm ²	LL	IEC: 500 V/32.5 A/0.5 - 6 mm ² UL: 300 V/20 A/AWG 28 - 12	●		●	
		TOP1.5GS	IEC: 630 V/24 A/0.5 - 2.5 mm ² UL: 300 V/10 A/AWG 26 - 14	●		●	
	TOP	≤ 6.0 mm ²	TOP4GS	IEC: 320 V/32 A/0.5 - 6 mm ² UL: 300 V/30 A/AWG 26 - 10	●		●
		Leaf spring ≤ 1.5 mm ²	PS	IEC: 320 V/17.5 A/0.2 - 1.5 mm ² UL: 300 V/10 A/AWG 28 - 16	●		
	≤ 2.5 mm ²		PM	IEC: 600 V/24 A/0.13 - 2.5 mm ² UL: 300 V/15 A/AWG 26 - 14	●		
	Spring	PUSH IN ≤ 1.5 mm ²	LSF-SMT	IEC: 320 V/17.5 A/0.2 - 1.5 mm ² UL: 300 V/12 A/AWG 24 - 16	●	●	●
LSF-SMD			IEC: 320 V/17.5 A/0.2 - 1.5 mm ² UL: 300 V/12 A/AWG 24 - 16			●	
Tension clamp ≤ 2.5 mm ²		LMZF	IEC: 630 V/24 A/0.13 - 2.5 mm ² UL: 300 V/15 A/AWG 26 - 14		●		

Pitch, in mm		3.50		3.81	5.00			5.08			6.35	7.50	7.62	9.52		10.00	10.16
Number of Levels		1	2	1	1	2	3	1	2	3	1	1	1	1	2	1	1
Reflow																	
THT	SMD																
		●	●														
		●															
								●									
					●			●	●	●							
					●	●		●	●	●		●	●			●	●
					●			●				●	●				
					●	●	●	●	●	●				●	●		
					●			●	●	●							
								●					●				
								●					●				
		●															
					●			●									
●		●		●	●			●				●	●				
●		●		●	●			●				●	●				
●		●		●	●			●				●	●				
	●	●															
					●			●	●	●		●	●			●	●

LM 3.5

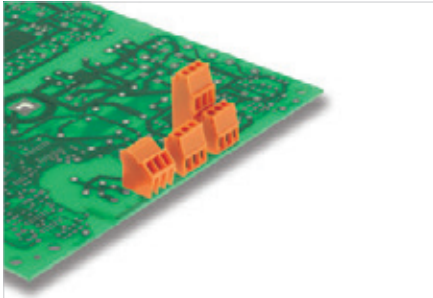

Small, compact PCB terminal with the proven clamping-yoke screw connection in 3.5 mm pitch, suitable for wire cross-sections up to 1.5 mm².

- Wire outlet direction: 90° and 135° version.
- 2- and 3-pole block construction can be aligned together for higher pole counts.

Technical data

In compliance with IEC 60664-1 / IEC 61984

Clamping range, max.	mm ²		
Solid core H05(07) V-U	mm ²		
Stranded H07 V-R			
Flexible H05(07) V-K	mm ²		
Flexible with ferrule	mm ²		
Ferrule with plastic collar	mm ²		
Stripping length	mm		
Screwdriver blade	mm		
According to norm			
Tightening torque range	Nm		
Rated current, max.	A	16	14
At ambient temperature		20°C	40°C
For conductor cross-section	mm ²		1.5
Overvoltage category		III	III II
Pollution severity		3	2 2
Rated voltage	V	160	160 320
Rated impulse voltage	kV	2.5	2.5 2.5
UL / CUL (Use Group)		B	C D
Rated voltage	V	300	300
Rated current	A	10	10
AWG conductor	AWG		28-14
CSA (Use Group)		B	C D
Rated voltage	V	300	300
Rated current	A	10	10
AWG conductor	AWG		28-14
General data			
Type of insulation material		PA	
UL 94 flammability rating		V-2	
Contact base material		Copper alloy	
Material of contact surface		tinned	
Pin dimensions = d	mm	1.0 x 0.6	
Solder eyelet Ø = D	mm	1.3	
Solder eyelet Ø tolerance	mm	+ 0,1	

Product data

IEC: 320 V / 16 A / 0.5 - 1.5 mm²
 UL: 300 V / 10 A / AWG 28 - 14

For additional articles and information, refer to catalog.weidmueller.com

Note:

- Additional colours on request
- Rated current related to rated cross-section & min. No. of poles.
- Max. outer diameter of the conductor: 2.9 mm
- Wire end ferrule with plastic collar to DIN 46228/4
- P on drawing = pitch
- Rated data refer only to the component itself. Clearance and creepage distances to other components are to be designed in accordance with the relevant application standards.

LM 3.5/..90



Dimensioned drawing

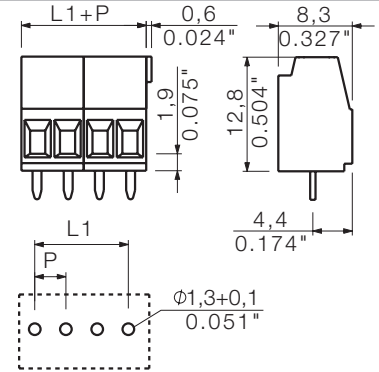

Ordering data

Solder pin length		3.2 mm		
Colour		Orange		
Pitch		3.50 mm		
Pol.	L1	(inch)	Qty.	Order No.
2	3.50	0.138	100	1667750000
3	7.00	0.276	100	1667770000
4	10.50	0.413	100	1845040000
5	14.00	0.551	100	1720250000
6	17.50	0.689	50	1845050000
7	21.00	0.827	50	1845060000
8	24.50	0.965	50	1845070000
9	28.00	1.102	50	1845080000
10	31.50	1.240	50	1845090000
11	35.00	1.378	50	1845100000
12	38.50	1.516	50	1845110000

Accessories

Note: Refer to the Accessories chapter for additional accessories.

Screwdriver		Order No.
	SDIS 0.4X2.5X75	9008370000
	SDS 0.4X2.5X75	9009030000

Representative deratings curve

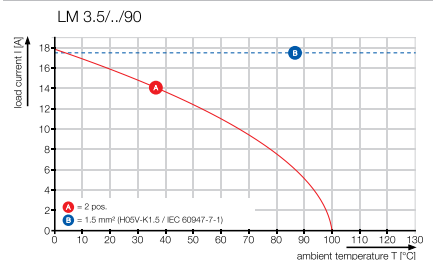

LM 3.5

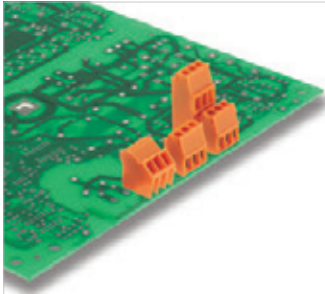

Small, compact PCB terminal with the proven clamping-yoke screw connection in 3.5 mm pitch, suitable for wire cross-sections up to 1.5 mm².

- Wire outlet direction: 90° and 135° version.
- 2- and 3-pole block construction can be aligned together for higher pole counts.

Technical data

In compliance with IEC 60664-1 / IEC 61984

Clamping range, max.	mm ²	0.08...2.08	
Solid core H05(07) V-U	mm²	0.5...1.5	
Stranded H07 V-R			
Flexible H05(07) V-K	mm ²	0.5...1.5	
Flexible with ferrule	mm ²		
Ferrule with plastic collar	mm ²	0.5...0.75	
Stripping length	mm	5	
Screwdriver blade	mm	0.4 x 2.5	
According to norm		DIN 5264	
Tightening torque range	Nm	0.2...0.25	
Rated current, max.	A	16	14
At ambient temperature		20°C	40°C
For conductor cross-section	mm ²	1.5	
Overvoltage category		III	III II
Pollution severity		3	2 2
Rated voltage	V	160	160 320
Rated impulse voltage	kV	2.5	2.5 2.5
UL / CUL (Use Group)		B	C D
Rated voltage	V	300	300
Rated current	A	10	10
AWG conductor	AWG	28-14	
CSA (Use Group)		B	C D
Rated voltage	V	300	300
Rated current	A	10	10
AWG conductor	AWG	28-14	
General data			
Type of insulation material		PA	
UL 94 flammability rating		V-2	
Contact base material		Copper alloy	
Material of contact surface		tinned	
Pin dimensions = d	mm	1.0 x 0.6	
Solder eyelet Ø = D	mm	1.3	
Solder eyelet Ø tolerance	mm	+ 0,1	

Product data

IEC: 320 V / 16 A / 0.5 - 1.5 mm²
UL: 300 V / 10 A / AWG 28 - 14

For additional articles and information, refer to catalog.weidmueller.com

Note:

- Additional colours on request
- Rated current related to rated cross-section & min. No. of poles.
- Max. outer diameter of the conductor: 2.9 mm
- Wire end ferrule with plastic collar to DIN 46228/4
- P on drawing = pitch
- Rated data refer only to the component itself. Clearance and creepage distances to other components are to be designed in accordance with the relevant application standards.

Accessories

Note: Refer to the Accessories chapter for additional accessories.

Screwdriver		Order No.
	SDIS 0.4X2.5X75	9008370000
	SDS 0.4X2.5X75	9009030000

LM 3.5/./135

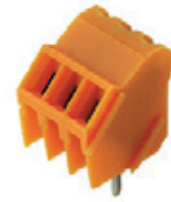

Dimensioned drawing

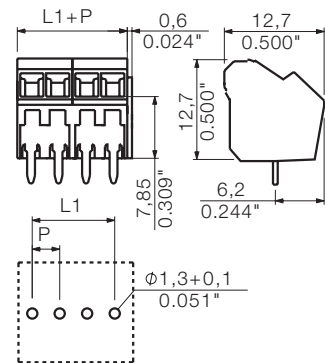

Ordering data

Solder pin length		3.2 mm		
Colour		Orange		
Pitch		3.50 mm		
Pol.	L1	(inch)	Qty.	Order No.
2	3.50	0.138	100	1714980000
3	7.00	0.276	100	1715020000
4	10.50	0.413	100	1845220000
5	14.00	0.551	50	1845230000
6	17.50	0.689	50	1845240000
7	21.00	0.827	50	1845250000
8	24.50	0.965	50	1845260000
9	28.00	1.102	50	1845270000
10	31.50	1.240	50	1845280000
11	35.00	1.378	50	1845290000
12	38.50	1.516	50	1845300000

Representative deratings curve

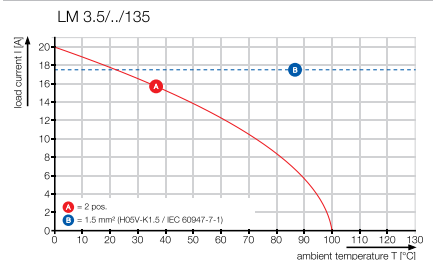

LM 3.5

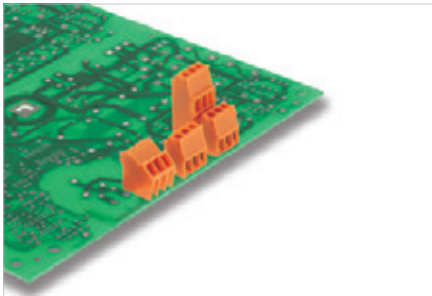

Small, compact PCB terminal with the proven clamping-yoke screw connection in 3.5 mm pitch, suitable for wire cross-sections up to 1.5 mm².

- Wire outlet direction: 90° and 135° version.
- 2- and 3-pole block construction can be aligned together for higher pole counts.

Technical data

In compliance with IEC 60664-1 / IEC 61984		
Clamping range, max.	mm ²	0.08...2.08
Solid core H05(07) V-U	mm ²	0.5...1.5
Stranded H07 V-R		
Flexible H05(07) V-K	mm ²	0.5...1.5
Flexible with ferrule	mm ²	
Ferrule with plastic collar	mm ²	0.5...0.75
Stripping length	mm	5
Screwdriver blade	mm	0.4 x 2.5
According to norm		DIN 5264
Tightening torque range	Nm	0.2...0.25
Rated current, max.	A	13 11
At ambient temperature	20°C	40°C
For conductor cross-section	mm ²	1.5
Overvoltage category		III III II
Pollution severity		3 2 2
Rated voltage	V	160 160 320
Rated impulse voltage	kV	2.5 2.5 2.5
UL / CUL (Use Group)	B C D	
Rated voltage	V	300 300
Rated current	A	10 10
AWG conductor	AWG	28-14
CSA (Use Group)	B C D	
Rated voltage	V	300 300
Rated current	A	10 10
AWG conductor	AWG	28-14
General data		
Type of insulation material		PA
UL 94 flammability rating		V-2
Contact base material		Copper alloy
Material of contact surface		tinned
Pin dimensions = d	mm	1.0 x 0.6
Solder eyelet Ø = D	mm	1.3
Solder eyelet Ø tolerance	mm	+ 0,1

Product data

IEC: 320 V / 13 A / 0.5 - 1.5 mm²
 UL: 300 V / 10 A / AWG 28 - 14

For additional articles and information, refer to catalog.weidmueller.com

Note:

- Additional colours on request
- Rated current related to rated cross-section & min. No. of poles.
- Max. outer diameter of the conductor: 2.9 mm
- Wire end ferrule with plastic collar to DIN 46228/4
- P on drawing = pitch
- Rated data refer only to the component itself. Clearance and creepage distances to other components are to be designed in accordance with the relevant application standards.

LM1N 3.5/./90



Dimensioned drawing

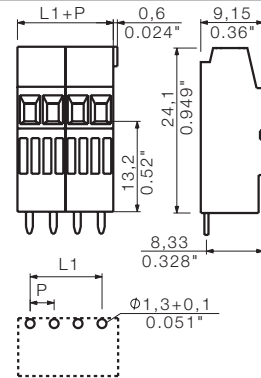

Ordering data

Solder pin length		3.2 mm		
Colour		Orange		
Pitch		3.50 mm		
Pol.	L1	(inch)	Qty.	Order No.
2	3.50	0.138	100	1716710000
3	7.00	0.276	100	1716720000

Accessories

Note: Refer to the Accessories chapter for additional accessories.

Screwdriver		Order No.
	SDIS 0.4X2.5X75	9008370000
	SDS 0.4X2.5X75	9009030000

Representative deratings curve

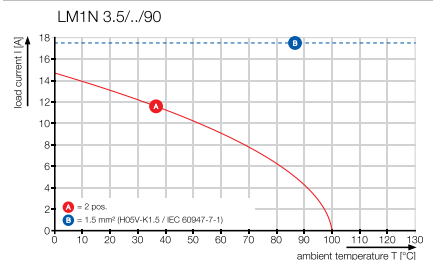

LM 3.5

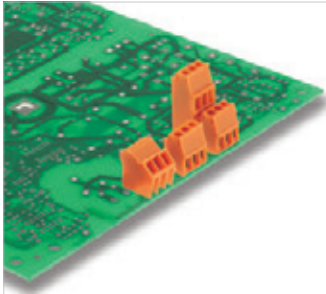

Small, compact PCB terminal with the proven clamping-yoke screw connection in 3.5 mm pitch, suitable for wire cross-sections up to 1.5 mm².

- Wire outlet direction: 90° and 135° version.
- 2- and 3-pole block construction can be aligned together for higher pole counts.

Product data

IEC: 320 V / 13 A / 0.5 - 1.5 mm²
UL: 300 V / 10 A / AWG 28 - 14

For additional articles and information, refer to catalog.weidmueller.com

Note:

- Additional colours on request
- Rated current related to rated cross-section & min. No. of poles.
- Max. outer diameter of the conductor: 2.9 mm
- Wire end ferrule with plastic collar to DIN 46228/4
- P on drawing = pitch
- Rated data refer only to the component itself. Clearance and creepage distances to other components are to be designed in accordance with the relevant application standards.

LM2N 3.5/./90

Multi level



Dimensioned drawing

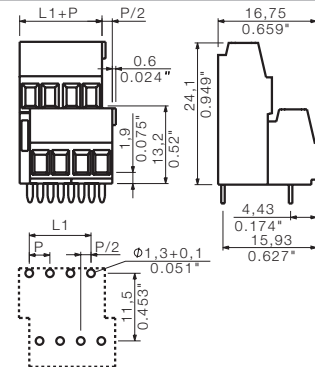

Technical data

In compliance with IEC 60664-1 / IEC 61984

Clamping range, max.	mm ²	0.08...2.08	
Solid core H05(07) V-U	mm²	0.5...1.5	
Stranded H07 V-R			
Flexible H05(07) V-K	mm ²	0.5...1.5	
Flexible with ferrule	mm ²		
Ferrule with plastic collar	mm ²	0.5...0.75	
Stripping length	mm	5	
Screwdriver blade	mm	0.4 x 2.5	
According to norm		DIN 5264	
Tightening torque range	Nm	0.2...0.2	
Rated current, max.	A	13	11
At ambient temperature		20°C	40°C
For conductor cross-section	mm ²	1.5	
Overtoltage category		III	III II
Pollution severity		3	2 2
Rated voltage	V	160	160 320
Rated impulse voltage	kV	2.5	2.5 2.5
UL / CUL (Use Group)		B	C D
Rated voltage	V	300	300
Rated current	A	10	10
AWG conductor	AWG	28-14	
CSA (Use Group)		B	C D
Rated voltage	V	300	300
Rated current	A	10	10
AWG conductor	AWG	28-14	
General data			
Type of insulation material		PA	
UL 94 flammability rating		V-2	
Contact base material		Copper alloy	
Material of contact surface		tinned	
Pin dimensions = d	mm	1.0 x 0.6	
Solder eyelet Ø = D	mm	1.3	
Solder eyelet Ø tolerance	mm	+ 0,1	

Accessories

Note: Refer to the Accessories chapter for additional accessories.

Screwdriver		Order No.
	SDIS 0.4X2.5X75	9008370000
	SDS 0.4X2.5X75	9009030000

Ordering data

Solder pin length		3.2 mm		
Colour		Orange		
Pitch		3.50 mm		
Pol.	L1	(inch)	Qty.	Order No.
4	3.50	0.138	100	1703700000
6	7.00	0.276	100	1703710000
8	10.50	0.413	100	1703720000
10	14.00	0.551	50	1703730000
12	17.50	0.689	50	1703740000
14	21.00	0.827	50	1703750000
16	24.50	0.965	50	1703760000
18	28.00	1.102	50	1703770000
20	31.50	1.240	50	1703780000
22	35.00	1.378	25	1703790000
24	38.50	1.516	25	1703800000
26	42.00	1.654	25	1703810000
28	45.50	1.791	25	1703820000
30	49.00	1.929	25	1703830000
32	52.50	2.067	25	1703840000
34	56.00	2.205	25	1703850000
36	59.50	2.343	25	1703860000
38	63.00	2.480	25	1703870000
40	66.50	2.618	25	1703880000
42	70.00	2.756	20	1703890000
44	73.50	2.894	20	1703900000
46	77.00	3.031	20	1703910000
48	80.50	3.169	20	1703920000

Representative deratings curve

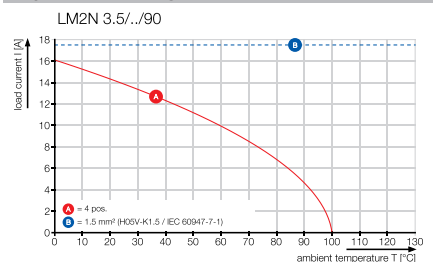

LS 5.08

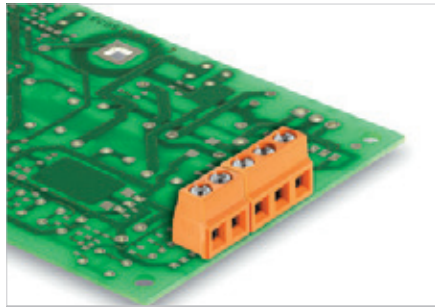

Small, compact PCB terminal with our proven clamping-yoke screw connection in 5.08 mm pitch, suitable for wire cross-sections up to 1.5 mm².

- Increased derating reserves because WEMID insulating material is used.
- Wire outlet direction of 90°.
- 2- and 3-pole block construction can be aligned together for higher pole counts.

Technical data

In compliance with IEC 60664-1 / IEC 61984			
Clamping range, max.	mm ²	0.08...1.5	
Solid core H05(07) V-U	mm ²	0.08...1.5	
Stranded H07 V-R			
Flexible H05(07) V-K	mm ²	0.08...1.5	
Flexible with ferrule	mm ²	0.25...1.5	
Ferrule with plastic collar	mm ²	0.25...1.5	
Stripping length	mm	6	
Screwdriver blade	mm	0.6 x 3.5	
According to norm		DIN 5264	
Tightening torque range	Nm	0.4...0.5	
Rated current, max.	A	17.5	17.5
At ambient temperature		20°C	40°C
For conductor cross-section	mm ²	1.5	
Overvoltage category		III	III II
Pollution severity		3	2 2
Rated voltage	V	250	320 630
Rated impulse voltage	kV	4	4 4
UL / CUL (Use Group)		B	C D
Rated voltage	V	300	300
Rated current	A	15	10
AWG conductor	AWG	28-14	
CSA (Use Group)		B	C D
Rated voltage	V	300	300
Rated current	A	20	10
AWG conductor	AWG	28-14	
General data			
Type of insulation material		Wemid (PA)	
UL 94 flammability rating		V-0	
Contact base material		Copper alloy	
Material of contact surface		tinned	
Pin dimensions = d	mm	0.5 x 1.0	
Solder eyelet Ø = D	mm	1.3	
Solder eyelet Ø tolerance	mm	+ 0,1	

Product data

IEC: 630 V / 17.5 A / 0.08 - 1.5 mm²
 UL: 300 V / 15 A / AWG 28 - 14

For additional articles and information, refer to catalog.weidmueller.com

Note:

- Rated current related to rated cross-section & min. No. of poles.
- Wire end ferrule without plastic collar to DIN 46228/1
- Wire end ferrule with plastic collar to DIN 46228/4
- P on drawing = pitch
- Rated data refer only to the component itself. Clearance and creepage distances to other components are to be designed in accordance with the relevant application standards.

LS 5.08/./90



Dimensioned drawing

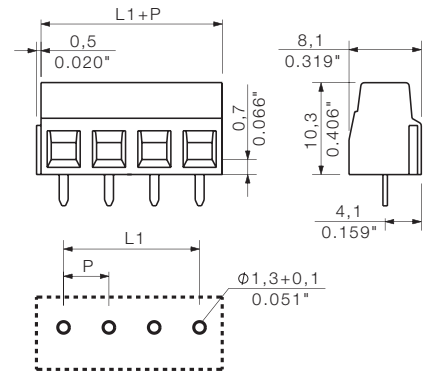

Ordering data

Solder pin length					3.5 mm
Colour					Orange
Pitch		5.08 mm			
Pol.	L1	(inch)	Qty.	Order No.	
2	5.08	0.200	100	1912520000	
3	10.16	0.400	100	1912530000	
4	15.24	0.600	100	1912540000	
5	20.32	0.800	100	1912560000	
6	25.40	1.000	100	1912570000	
7	30.48	1.200	100	1912850000	
8	35.56	1.400	100	1912890000	
9	40.64	1.600	100	1912900000	
10	45.72	1.800	100	1912910000	
11	50.80	2.000	100	1912930000	
12	55.88	2.200	100	1912940000	

Accessories

Note: Refer to the Accessories chapter for additional accessories.

Screwdriver		Order No.
	SDIS 0.6X3.5X100	9008390000
	SDS 0.6X3.5X100	9008330000

Representative deratings curve

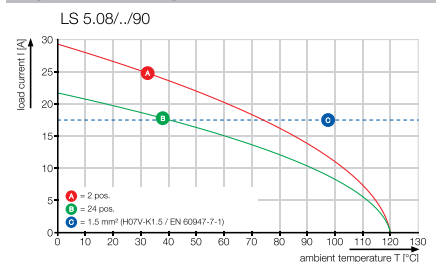

LM 5.00

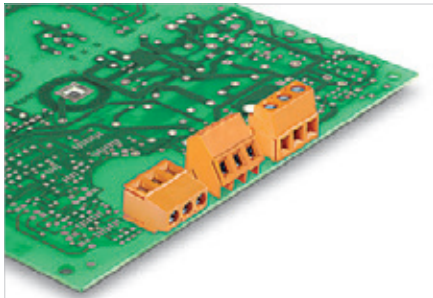

Single-row PCB terminal with our proven clamping-yoke screw connection in 5.00 mm pitch, suitable for wire cross-sections up to 2.5 mm².

- Increased derating reserves because WEMID insulating material is used.
- Wire outlet direction: 90°, 135° and 180° versions.
- 2- and 3-pole block construction can be aligned together for higher pole counts.

Technical data

In compliance with IEC 60664-1 / IEC 61984			
Clamping range, max.	mm ²	0.2...2.5	
Solid core H05(07) V-U	mm²	0.2...2.5	
Stranded H07 V-R			
Flexible H05(07) V-K	mm ²	0.2...1.5	
Flexible with ferrule	mm ²	0.25...1.5	
Ferrule with plastic collar	mm ²	0.25...1.5	
Stripping length	mm	6	
Screwdriver blade	mm	0.6 x 3.5	
According to norm		DIN 5264	
Tightening torque range	Nm	0.4...0.5	
Rated current, max.	A	17.5	17.5
At ambient temperature		20°C	40°C
For conductor cross-section	mm ²	1.5	
Overvoltage category		III	III II
Pollution severity		3	2 2
Rated voltage	V	250	320 630
Rated impulse voltage	kV	4	4 4
UL / CUL (Use Group)		B	C D
Rated voltage	V	300	300
Rated current	A	15	10
AWG conductor	AWG	24-14	
CSA (Use Group)		B	C D
Rated voltage	V	300	300
Rated current	A	18	10
AWG conductor	AWG	24-14	
General data			
Type of insulation material		Wemid (PA)	
UL 94 flammability rating		V-0	
Contact base material		Copper alloy	
Material of contact surface		tinned	
Pin dimensions = d	mm	0.95 x 0.8	
Solder eyelet Ø = D	mm	1.3	
Solder eyelet Ø tolerance	mm	+ 0,1	

Product data

IEC: 630 V / 17.5 A / 0.2 - 2.5 mm²
 UL: 300 V / 15 A / AWG 24 - 14

For additional articles and information, refer to catalog.weidmuller.com

Note:

- Rated current related to rated cross-section & min. No. of poles.
- Wire end ferrule without plastic collar to DIN 46228/1
- Wire end ferrule with plastic collar to DIN 46228/4
- P on drawing = pitch
- Rated data refer only to the component itself. Clearance and creepage distances to other components are to be designed in accordance with the relevant application standards.

LM 5.00/..90



Dimensioned drawing

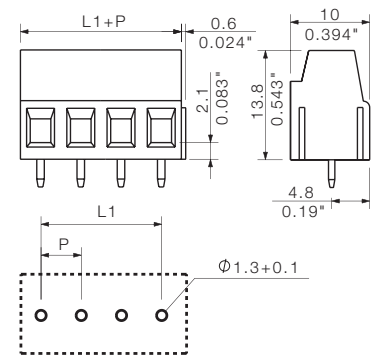

Accessories

Note: Refer to the Accessories chapter for additional accessories.

Screwdriver		Order No.
	SDIS 0.6X3.5X100	9008390000
	SDS 0.6X3.5X100	9008330000

Ordering data

Solder pin length		3.5 mm		
Colour		Orange		
Pitch	5.00 mm			
Pol.	L1	(inch)	Qty.	Order No.
2	5.00	0.197	500	1715310000
3	10.00	0.394	500	1715320000
4	15.00	0.591	50	1821490000
5	20.00	0.787	50	1845310000
6	25.00	0.984	50	1845320000
7	30.00	1.181	50	1845330000
8	35.00	1.378	50	1845340000
9	40.00	1.575	50	1845350000
10	45.00	1.772	50	1845360000
11	50.00	1.969	50	1845370000
12	55.00	2.165	50	1845380000

Representative deratings curve

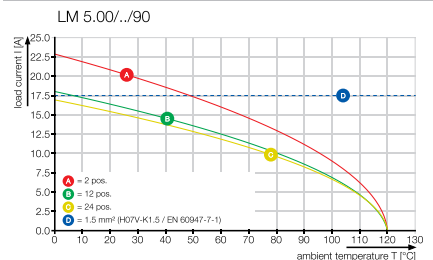

LM 5.00../135



Dimensioned drawing

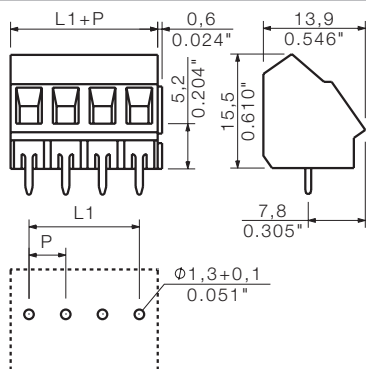

Ordering data

Solder pin length		3.5 mm		
Colour		Orange		
Pitch		5.00 mm		
Pol.	L1	(inch)	Qty.	Order No.
2	5.00	0.197	500	1715350000
3	10.00	0.394	500	1715360000
4	15.00	0.591	50	1845390000
5	20.00	0.787	50	1845400000
6	25.00	0.984	50	1845410000
7	30.00	1.181	50	1845420000
8	35.00	1.378	50	1845430000
9	40.00	1.575	50	1845440000
10	45.00	1.772	50	1845450000
11	50.00	1.969	50	1845460000
12	55.00	2.165	50	1845470000

LM 5.00../180



Dimensioned drawing

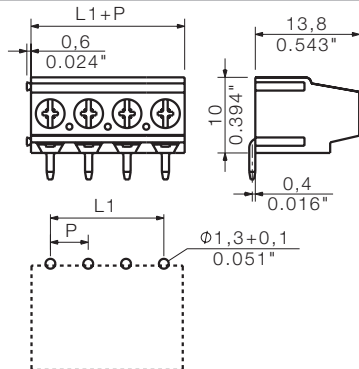

Ordering data

Solder pin length		3.5 mm		
Colour		Orange		
Pitch		5.00 mm		
Pol.	L1	(inch)	Qty.	Order No.
2	5.00	0.197	500	1715330000
3	10.00	0.394	500	1715340000

Additional deratings curves

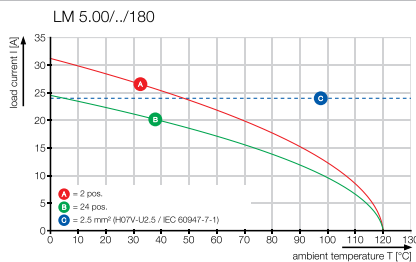
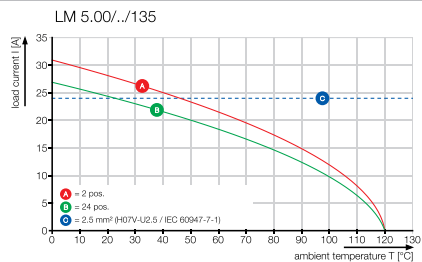

LM 5.08

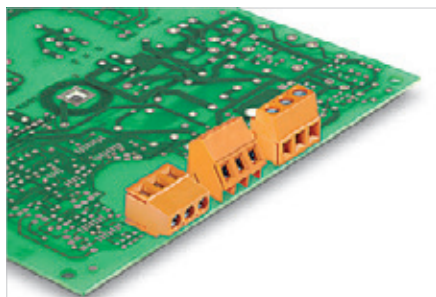

Single-row PCB terminal with our proven clamping-yoke screw connection in 5.08 mm pitch, suitable for wire cross-sections up to 2.5 mm².

- Increased derating reserves because WEMID insulating material is used.
- Wire outlet direction: 90°, 135° and 180° versions.
- 2- and 3-pole block construction can be aligned together for higher pole counts.

Technical data

In compliance with IEC 60664-1 / IEC 61984			
Clamping range, max.	mm ²	0.2...2.5	
Solid core H05(07) V-U	mm ²	0.2...2.5	
Stranded H07 V-R			
Flexible H05(07) V-K	mm ²	0.2...1.5	
Flexible with ferrule	mm ²	0.25...1.5	
Ferrule with plastic collar	mm ²	0.25...1.5	
Stripping length	mm	6	
Screwdriver blade	mm	0.6 x 3.5	
According to norm		DIN 5264	
Tightening torque range	Nm	0.4...0.5	
Rated current, max.	A	17.5	17.5
At ambient temperature		20°C	40°C
For conductor cross-section	mm ²	1.5	
Overtoltage category		III	III II
Pollution severity		3	2 2
Rated voltage	V	250	320 630
Rated impulse voltage	kV	4	4 4
UL / CUL (Use Group)		B	C D
Rated voltage	V	300	300
Rated current	A	15	10
AWG conductor	AWG	24-14	
CSA (Use Group)		B	C D
Rated voltage	V	300	300
Rated current	A	18	10
AWG conductor	AWG	24-14	
General data			
Type of insulation material		Wemid (PA)	
UL 94 flammability rating		V-0	
Contact base material		Copper alloy	
Material of contact surface		tinned	
Pin dimensions = d	mm	0.95 x 0.8	
Solder eyelet Ø = D	mm	1.3	
Solder eyelet Ø tolerance	mm	+ 0,1	

Product data

IEC: 630 V / 17.5 A / 0.2 - 2.5 mm²
 UL: 300 V / 15 A / AWG 24 - 14

For additional articles and information, refer to catalog.weidmueller.com

Note:

- Rated current related to rated cross-section & min. No. of poles.
- Wire end ferrule without plastic collar to DIN 46228/1
- Wire end ferrule with plastic collar to DIN 46228/4
- P on drawing = pitch
- Rated data refer only to the component itself. Clearance and creepage distances to other components are to be designed in accordance with the relevant application standards.

LM 5.08../90



Dimensioned drawing

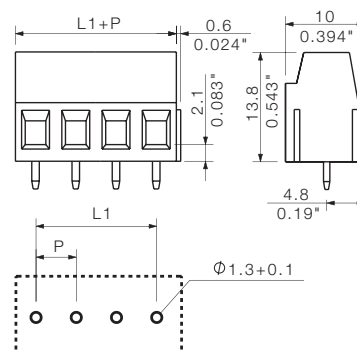

Accessories

Note: Refer to the Accessories chapter for additional accessories.

Screwdriver	Order No.
SDIS 0.6X3.5X100	9008390000
SDS 0.6X3.5X100	9008330000

Ordering data

Solder pin length		3.5 mm		
Colour		Orange		
Pitch		5.08 mm		
Pol.	L1	(inch)	Qty.	Order No.
2	5.08	0.200	500	1716080000
3	10.16	0.400	500	1716090000
4	15.24	0.600	50	9994130000
5	20.32	0.800	50	9994140000
6	25.40	1.000	50	9994150000
7	30.48	1.200	50	9994160000
8	35.56	1.400	50	9994170000
9	40.64	1.600	50	9994180000
10	45.72	1.800	50	9994190000
11	50.80	2.000	50	9994200000
12	55.88	2.200	50	9994210000
13	60.96	2.400	50	9994220000
14	66.04	2.600	50	9994230000
15	71.12	2.800	50	9994240000
16	76.20	3.000	50	9994250000
17	81.28	3.200	50	9994260000
18	86.36	3.400	50	9994270000
19	91.44	3.600	50	9994280000
20	96.52	3.800	50	9994290000
21	101.60	4.000	50	9994300000
22	106.68	4.200	50	9994310000
23	111.76	4.400	50	9994320000
24	116.84	4.600	50	9994330000

Representative deratings curve

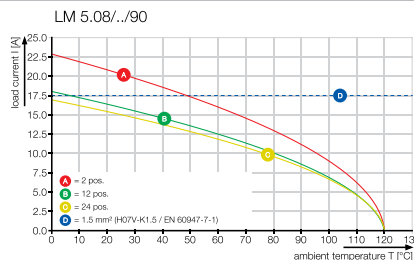

LM 5.08../135



Dimensioned drawing

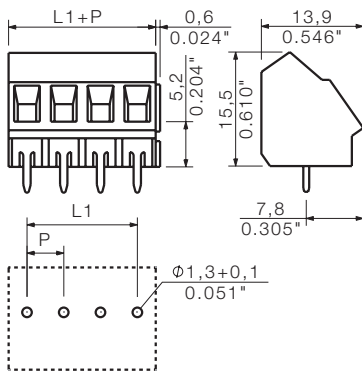

Ordering data

Solder pin length		3.5 mm	
Colour		Orange	
Pitch		5.08 mm	
Pol.	L1	(inch)	Qty. Order No.
2	5.08	0.200	500 1716120000
3	10.16	0.400	500 1716130000
4	15.24	0.600	50 9994550000
5	20.32	0.800	50 9994560000
6	25.40	1.000	50 9994570000
7	30.48	1.200	50 9994580000
8	35.56	1.400	50 9994590000
9	40.64	1.600	50 9994600000
10	45.72	1.800	50 9994610000
11	50.80	2.000	50 9994620000
12	55.88	2.200	50 9994630000
13	60.96	2.400	50 9994640000
14	66.04	2.600	50 9994650000
15	71.12	2.800	50 9994660000
16	76.20	3.000	50 9994670000
17	81.28	3.200	50 9994680000
18	86.36	3.400	50 9994690000
19	91.44	3.600	50 9994700000
20	96.52	3.800	50 9994710000
21	101.60	4.000	50 9994720000
22	106.68	4.200	50 9994730000
23	111.76	4.400	50 9994740000
24	116.84	4.600	50 9994750000

LM 5.08../180



Dimensioned drawing

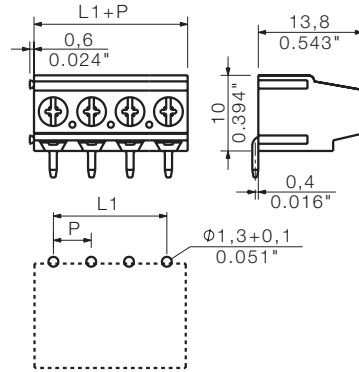

Ordering data

Solder pin length		3.5 mm	
Colour		Orange	
Pitch		5.08 mm	
Pol.	L1	(inch)	Qty. Order No.
2	5.08	0.200	500 1716100000
3	10.16	0.400	500 1716110000
4	15.24	0.600	50 9994970000
5	20.32	0.800	50 9994980000
6	25.40	1.000	50 9994990000
7	30.48	1.200	50 9995000000
8	35.56	1.400	50 9995010000
9	40.64	1.600	50 9995020000
10	45.72	1.800	50 9995030000
11	50.80	2.000	50 9995040000
12	55.88	2.200	50 9995050000
13	60.96	2.400	50 9995060000
14	66.04	2.600	50 9995070000
15	71.12	2.800	50 9995080000
16	76.20	3.000	50 9995090000
17	81.28	3.200	50 9995100000
18	86.36	3.400	50 9995110000
19	91.44	3.600	50 9995120000
20	96.52	3.800	50 9995130000
21	101.60	4.000	50 9995140000
22	106.68	4.200	50 9995150000
23	111.76	4.400	50 9995210000
24	116.84	4.600	50 9995220000

Additional deratings curves

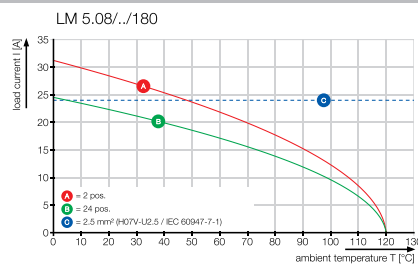
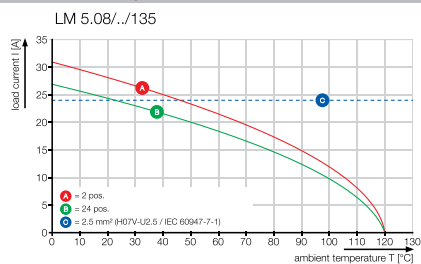

LM 5.08, multi level

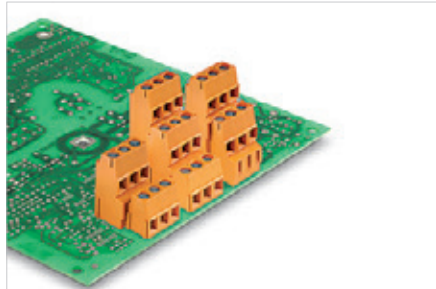

Multi-level PCB terminal with our proven clamping-yoke screw connection in 5.08 mm pitch, suitable for wire cross-sections up to 2.5 mm².

- Increased derating reserves because WEMID insulating material is used.
- Wire outlet direction of 90°.
- Block construction can be aligned together for higher pole counts.

Technical data

In compliance with IEC 60664-1 / IEC 61984		
Clamping range, max.	mm ²	0.2...2.5
Solid core H05(07) V-U	mm ²	0.2...2.5
Stranded H07 V-R		
Flexible H05(07) V-K	mm ²	0.2...1.5
Flexible with ferrule	mm ²	0.25...1.5
Ferrule with plastic collar	mm ²	0.25...1.5
Stripping length	mm	6
Screwdriver blade	mm	0.6 x 3.5
According to norm		DIN 5264
Tightening torque range	Nm	0.4...0.5
Rated current, max.	A	17.5 17.5
At ambient temperature		20°C 40°C
For conductor cross-section	mm ²	1.5
Overtoltage category		III III II
Pollution severity		3 2 2
Rated voltage	V	250 320 630
Rated impulse voltage	kV	4 4 4
UL / CUL (Use Group)		B C D
Rated voltage	V	300 300
Rated current	A	15 10
AWG conductor	AWG	24-14
CSA (Use Group)		B C D
Rated voltage	V	300 300
Rated current	A	18 10
AWG conductor	AWG	24-14
General data		
Type of insulation material		Wemid (PA)
UL 94 flammability rating		V-0
Contact base material		Copper alloy
Material of contact surface		tinned
Pin dimensions = d	mm	0.95 x 0.8
Solder eyelet Ø = D	mm	1.3
Solder eyelet Ø tolerance	mm	+ 0,1

Product data

IEC: 630 V / 17.5 A / 0.2 - 2.5 mm²
 UL: 300 V / 15 A / AWG 24 - 14

For additional articles and information, refer to catalog.weidmueller.com

Note:

- Rated current related to rated cross-section & min. No. of poles.
- Wire end ferrule without plastic collar to DIN 46228/1
- Wire end ferrule with plastic collar to DIN 46228/4
- P on drawing = pitch
- Rated data refer only to the component itself. Clearance and creepage distances to other components are to be designed in accordance with the relevant application standards.

LM1N 5.08/./90

Single row, middle



Dimensioned drawing

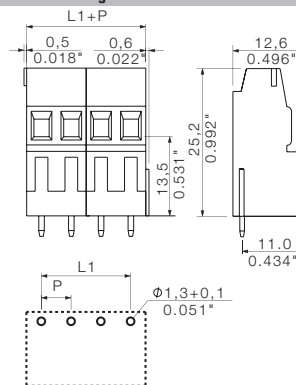

Ordering data

Solder pin length		3.5 mm	
Colour		Orange	
Pitch		5.08 mm	
Pol.	L1	(inch)	Qty. Order No.
2	5.08	0.200	100 1766300000
3	10.16	0.400	100 1766310000

Accessories

Note: Refer to the Accessories chapter for additional accessories.

Screwdriver	Order No.
SDIS 0.6X3.5X100	9008390000
SDS 0.6X3.5X100	9008330000

Representative deratings curve

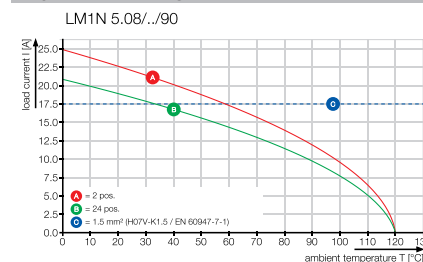

LM1H 5.08/./90

Single row, high

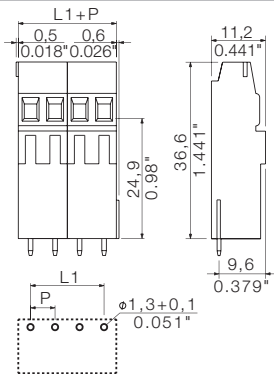
**Dimensioned drawing****Ordering data**

Solder pin length		3.5 mm		
Colour		Orange		
Pitch		5.08 mm		
Pol.	L1	(inch)	Qty.	Order No.
2	5.08	0.200	100	1766360000
3	10.16	0.400	100	1766370000

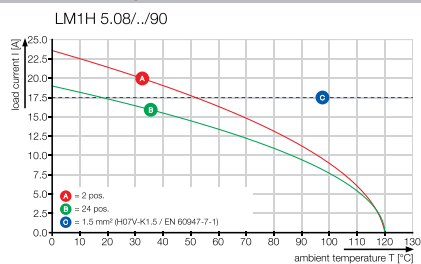
Additional deratings curves

LM 5.08, multi level

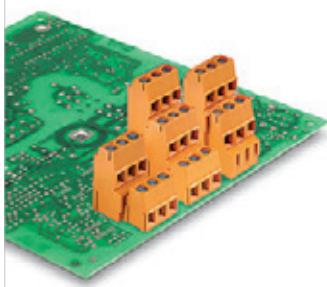

Multi-level PCB terminal with our proven clamping-yoke screw connection in 5.08 mm pitch, suitable for wire cross-sections up to 2.5 mm².

- Increased derating reserves because WEMID insulating material is used.
- Wire outlet direction of 90°.
- Block construction can be aligned together for higher pole counts.

Technical data

In compliance with IEC 60664-1 / IEC 61984

Clamping range, max.	mm ²	0.2...2.5
Solid core H05(07) V-U	mm²	0.2...2.5
Stranded H07 V-R		
Flexible H05(07) V-K	mm ²	0.2...1.5
Flexible with ferrule	mm ²	0.25...1.5
Ferrule with plastic collar	mm ²	0.25...1.5
Stripping length	mm	6
Screwdriver blade	mm	0.6 x 3.5
According to norm		DIN 5264
Tightening torque range	Nm	0.4...0.5
Rated current, max.	A	17.5 17.5
At ambient temperature	20°C 40°C	
For conductor cross-section	mm ²	1.5
Overtolerance category		III III II
Pollution severity		3 2 2
Rated voltage	V	250 320 630
Rated impulse voltage	kV	4 4 4
UL / CUL (Use Group)	B C D	D
Rated voltage	V	300 300
Rated current	A	15 10
AWG conductor	AWG	24-14
CSA (Use Group)	B C D	D
Rated voltage	V	300 300
Rated current	A	18 10
AWG conductor	AWG	24-14
General data		
Type of insulation material		Wemid (PA)
UL 94 flammability rating		V-0
Contact base material		Copper alloy
Material of contact surface		tinned
Pin dimensions = d	mm	0.95 x 0.8
Solder eyelet Ø = D	mm	1.3
Solder eyelet Ø tolerance	mm	+ 0,1

Product data

IEC: 630 V / 17.5 A / 0.2 - 2.5 mm²
 UL: 300 V / 15 A / AWG 24 - 14

For additional articles and information, refer to catalog.weidmueller.com

Note:

- Rated current related to rated cross-section & min. No. of poles.
- Wire end ferrule without plastic collar to DIN 46228/1
- Wire end ferrule with plastic collar to DIN 46228/4
- P on drawing = pitch
- Rated data refer only to the component itself. Clearance and creepage distances to other components are to be designed in accordance with the relevant application standards.

LM2N 5.08/..90

Double level row



Dimensioned drawing

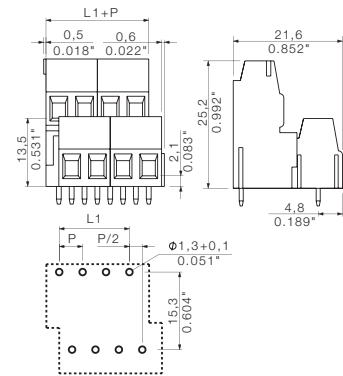

Ordering data

Solder pin length		3.5 mm		
Colour		Orange		
Pitch		5.08 mm		
Pol.	L1	(inch)	Qty.	Order No.
4	5.08	0.200	50	1768850000
6	10.16	0.400	50	1768860000
8	15.24	0.600	50	1768870000
10	20.32	0.800	50	1768880000
12	25.40	1.000	20	1768890000
14	30.48	1.200	20	1768900000
16	35.56	1.400	20	1768910000
18	40.64	1.600	20	1768920000
20	45.72	1.800	20	1768930000
22	50.80	2.000	20	1768940000
24	55.88	2.200	10	1768950000
26	60.96	2.400	10	1768960000
28	66.04	2.600	10	1768970000
30	71.12	2.800	10	1768980000
32	76.20	3.000	10	1768990000
34	81.28	3.200	10	1769000000
36	86.36	3.400	10	1769010000
38	91.44	3.600	10	1769020000
40	96.52	3.800	10	1769030000
42	101.60	4.000	10	1769040000
44	106.68	4.200	10	1769050000
46	111.76	4.400	10	1769060000
48	116.84	4.600	10	1769070000

Representative deratings curve

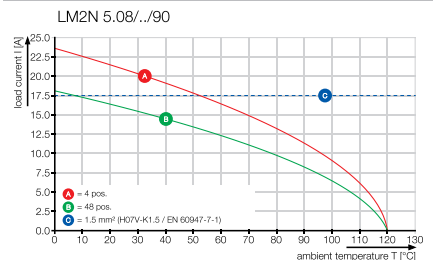

LM2H 5.08../90

Double level row high



Dimensioned drawing

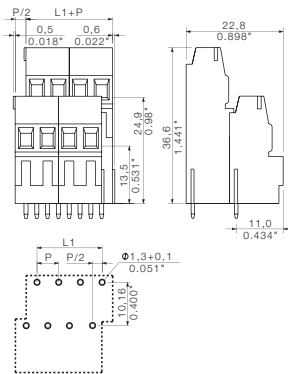

Ordering data

Solder pin length		3.5 mm	
Colour		Orange	
Pitch		5.08 mm	
Pol.	L1 (inch)	Qty.	Order No.
4	5.08	0.200	50 1769240000
6	10.16	0.400	50 1769250000
8	15.24	0.600	50 1769260000
10	20.32	0.800	50 1769270000
12	25.40	1.000	20 1769280000
14	30.48	1.200	20 1769290000
16	35.56	1.400	20 1769300000
18	40.64	1.600	20 1769310000
20	45.72	1.800	20 1769320000
22	50.80	2.000	20 1769330000
24	55.88	2.200	10 1769340000
26	60.96	2.400	10 1769350000
28	66.04	2.600	10 1769360000
30	71.12	2.800	10 1769370000
32	76.20	3.000	10 1769380000
34	81.28	3.200	10 1769390000
36	86.36	3.400	10 1769400000
38	91.44	3.600	10 1769410000
40	96.52	3.800	10 1769420000
42	101.60	4.000	10 1769430000
44	106.68	4.200	10 1769440000
46	111.76	4.400	10 1769450000
48	111.76	4.400	10 1769460000

LM3R 5.08../90

Triple level



Dimensioned drawing

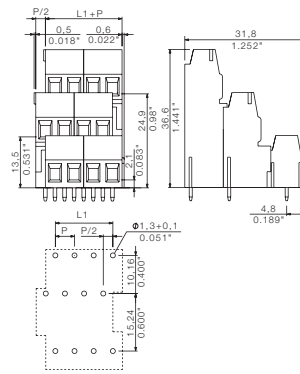

Ordering data

Solder pin length		3.5 mm	
Colour		Orange	
Pitch		5.08 mm	
Pol.	L1 (inch)	Qty.	Order No.
6	5.08	0.200	50 1769620000
9	10.16	0.400	50 1769630000
12	15.24	0.600	50 1769640000
15	20.32	0.800	25 1769650000
18	25.40	1.000	25 1769660000
21	30.48	1.200	20 1769670000
24	35.56	1.400	20 1769680000
27	40.64	1.600	20 1769690000
30	45.72	1.800	10 1769700000
33	50.80	2.000	10 1769710000
36	55.88	2.200	10 1769720000
39	60.96	2.400	10 1769730000
42	66.04	2.600	10 1769740000
45	71.12	2.800	10 1769750000
48	76.20	3.000	10 1769760000
51	81.28	3.200	10 1769770000
54	86.36	3.400	5 1769780000
57	91.44	3.600	5 1769790000
60	96.52	3.800	5 1769800000
63	101.60	4.000	5 1769810000
66	106.68	4.200	5 1769820000
69	111.76	4.400	5 1769830000
72	116.84	4.600	5 1769840000

Additional deratings curves

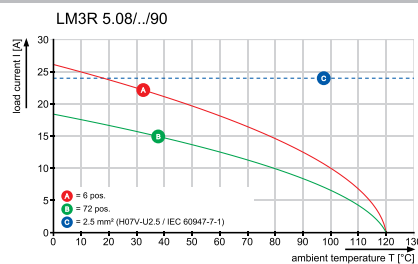
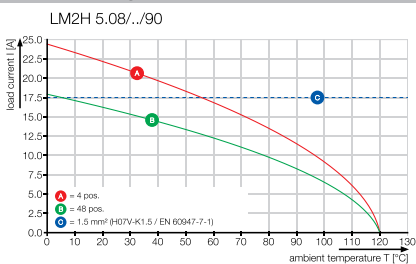

LP & LPP 5.00

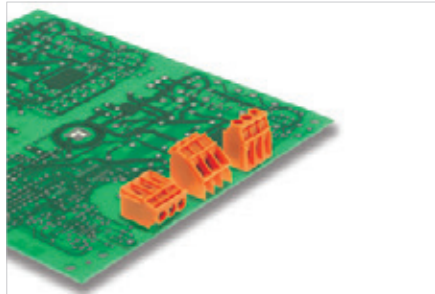

Single-row PCB terminal with our proven clamping-yoke screw connection in 5.00 mm pitch, suitable for wire cross-sections up to 6.0 mm².

- Wire outlet direction: 90°, 135° and 180° versions.
- 90° and 135° versions optionally with integrated test point for test plug PS 2.0.
- Version with a wide variety of extra functions.
- 2- and 3-pole block construction can be aligned together for higher pole counts.

Technical data

In compliance with IEC 60664-1 / IEC 61984			
Clamping range, max.	mm ²	0.13...6	
Solid core H05(07) V-U	mm²	0.5...6	
Stranded H07 V-R			
Flexible H05(07) V-K	mm ²	0.5...4	
Flexible with ferrule	mm ²	0.5...2.5	
Ferrule with plastic collar	mm ²	0.5...2.5	
Stripping length	mm	6	
Screwdriver blade	mm		
According to norm			
Tightening torque range	Nm	0.5...0.6	
Rated current, max.	A	32	32
At ambient temperature	20°C	40°C	
For conductor cross-section	mm ²	2.5	
Overvoltage category		III	III II
Pollution severity		3	2 2
Rated voltage	V	250	250 500
Rated impulse voltage	kV	4	4 4
UL / CUL (Use Group)		B	C D
Rated voltage	V	300	300
Rated current	A	20	10
AWG conductor	AWG	26-12	
CSA (Use Group)		B	C D
Rated voltage	V	300	300
Rated current	A	20	10
AWG conductor	AWG	26-12	
General data			
Type of insulation material		PA	
UL 94 flammability rating		V-2	
Contact base material		Copper alloy	
Material of contact surface		tinned	
Pin dimensions = d	mm	0.75 x 0.9	
Solder eyelet Ø = D	mm	1.3	
Solder eyelet Ø tolerance	mm	+ 0,1	

Product data

IEC: 500 V / 32 A / 0.5 - 6 mm²
 UL: 300 V / 20 A / AWG 26 - 12

For additional articles and information, refer to catalog.weidmueller.com

Note:

- Additional colours on request
- Rated current related to rated cross-section & min. No. of poles.
- Wire end ferrule without plastic collar to DIN 46228/1
- Wire end ferrule with plastic collar to DIN 46228/4
- P on drawing = pitch
- Rated data refer only to the component itself. Clearance and creepage distances to other components are to be designed in accordance with the relevant application standards.

LPP 5.00/./90

with test point



Dimensioned drawing

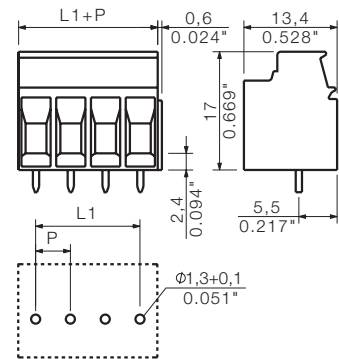



Ordering data

Solder pin length		3.2 mm		
Colour		Orange		
Pitch		5.00 mm		
Pol.	L1	(inch)	Qty.	Order No.
2	5.00	0.197	100	1594340000
3	10.00	0.394	100	1594350000

Accessories

Note: Refer to the Accessories chapter for additional accessories.

Marker holder and functional holder		Order No.
	LPA BZ2	1497260000
	LPA BZ3	1497360000
	LPA FA2	1495960000
	LPA FA2 BZ	1496160000
	LPA FA3	1496060000
	LPA FA3 BZ	1496260000
Fuse and disconnection element		
	LPA SI STI3.2 OR	1495060000
	LPA TR STI3.2 OR	1495460000
Intermediate plate + mounting block		
	LPBB MU OR	1747530000
	LPBB OR	1747540000
	LPHP 7.XX OR	1753440000
	LPZP 1.27/90 OR	1747490000
	LPZP 2.54/135 OR	1753740000
	LPZP 2.54/90 OR	1747480000
	LPZP1N 2.54 OR	1747470000
Cross-connection		
	LPA QB 10	1472500000
	LPA QB 17	1584770000
	LPA QB 2	1472200000
	LPA QB 24	1472600000
	LPA QB 3	1472300000
	LPA QB 4	1472400000
Screwdriver		
	SDIS 0.6X3.5X100	9008390000
	SDS 0.6X3.5X100	9008330000

Representative deratings curve

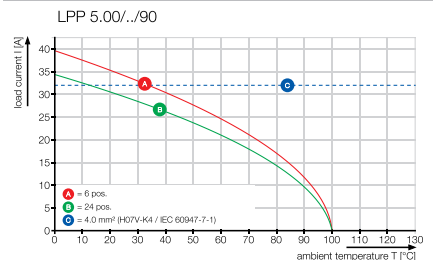

LP 5.00/./135

with test point



LP 5.00/./180



Dimensioned drawing

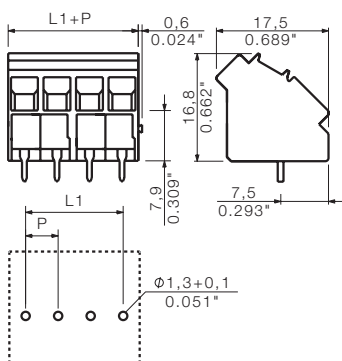

Dimensioned drawing

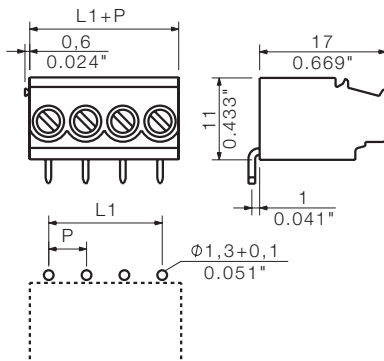

Ordering data

Solder pin length		3.2 mm		
Colour		Orange		
Pitch		5.00 mm		
Pol.	L1	(inch)	Qty.	Order No.
2	5.00	0.197	100	1595750000
3	10.00	0.394	100	1595710000
4	15.00	0.591	50	1791710000
5	20.00	0.787	50	1843210000
6	25.00	0.984	50	1843220000
7	30.00	1.181	50	1843230000
8	35.00	1.378	50	1843240000
9	40.00	1.575	50	1843250000
10	45.00	1.772	50	1843260000
11	50.00	1.969	50	1843270000
12	55.00	2.165	50	1843280000

Ordering data

Solder pin length		3.2 mm		
Colour		Orange		
Pitch		5.00 mm		
Pol.	L1	(inch)	Qty.	Order No.
2	5.00	0.197	100	1761330000
3	10.00	0.394	100	1761340000

Additional deratings curves

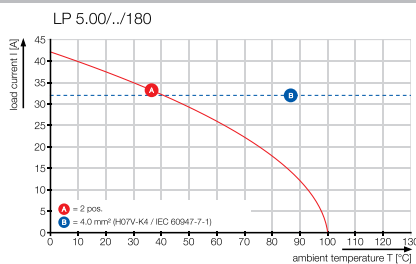
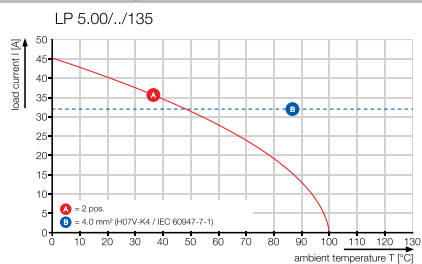

LP & LPP 5.08

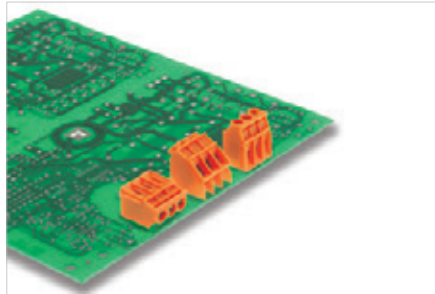

Single-row PCB terminal with our proven clamping-yoke screw connection in 5.08 mm pitch, suitable for wire cross-sections up to 6.0 mm².

- Wire outlet direction: 90°, 135° and 180° versions.
- 90° and 135° versions optionally with integrated test point for test plug PS 2.0.
- Version with a wide variety of extra functions.
- 2- and 3-pole block construction can be aligned together for higher pole counts.

Technical data

In compliance with IEC 60664-1 / IEC 61984			
Clamping range, max.	mm ²	0.13...6	
Solid core H05(07) V-U	mm²	0.5...6	
Stranded H07 V-R			
Flexible H05(07) V-K	mm ²	0.5...4	
Flexible with ferrule	mm ²	0.5...2.5	
Ferrule with plastic collar	mm ²	0.5...2.5	
Stripping length	mm	6	
Screwdriver blade	mm	0.6 x 3.5	
According to norm		DIN 5264	
Tightening torque range	Nm	0.5...0.6	
Rated current, max.	A	32	32
At ambient temperature		20°C	40°C
For conductor cross-section	mm ²		
Overvoltage category		III	III II
Pollution severity		3	2 2
Rated voltage	V	250	250 500
Rated impulse voltage	kV	4	4 4
UL / CUL (Use Group)	B C D	B	C D
Rated voltage	V	300	300
Rated current	A	20	10
AWG conductor	AWG	26-12	
CSA (Use Group)	B C D	B	C D
Rated voltage	V	300	300
Rated current	A	20	10
AWG conductor	AWG	26-12	
General data			
Type of insulation material		PA	
UL 94 flammability rating		V-2	
Contact base material		Copper alloy	
Material of contact surface		tinned	
Pin dimensions = d	mm	0.75 x 0.9	
Solder eyelet Ø = D	mm	1.3	
Solder eyelet Ø tolerance	mm	+ 0,1	

Product data

IEC: 500 V / 32 A / 0.5 - 6 mm²
 UL: 300 V / 20 A / AWG 26 - 12

For additional articles and information, refer to catalog.weidmueller.com

Note:

- Additional colours on request
- Rated current related to rated cross-section & min. No. of poles.
- Wire end ferrule without plastic collar to DIN 46228/1
- Wire end ferrule with plastic collar to DIN 46228/4
- P on drawing = pitch
- Rated data refer only to the component itself. Clearance and creepage distances to other components are to be designed in accordance with the relevant application standards.

LPP 5.08/./90

with test point



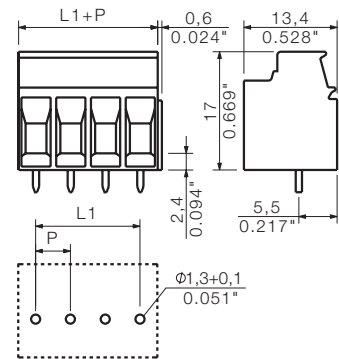

Dimensioned drawing



Accessories

Note: Refer to the Accessories chapter for additional accessories.

Marker holder and functional holder		Order No.
	LPA B22	1497260000
	LPA BZ3	1497360000
	LPA FA2	1495960000
	LPA FA2 BZ	1496160000
	LPA FA3	1496060000
	LPA FA3 BZ	1496260000
Fuse and disconnection element		
	LPA SI STI3.2 OR	1495060000
	LPA TR STI3.2 OR	1495460000
Intermediate plate + mounting block		
	LPBB MU OR	1747530000
	LPBB OR	1747540000
	LPHP 7.XX OR	1753440000
	LPZP 1.27/90 OR	1747490000
	LPZP 2.54/135 OR	1753740000
	LPZP 2.54/90 OR	1747480000
	LPZP1N 2.54 OR	1747470000
Cross-connection		
	LPA QB 10	1472500000
	LPA QB 17	1584770000
	LPA QB 2	1472200000
	LPA QB 24	1472600000
	LPA QB 3	1472300000
	LPA QB 4	1472400000
Screwdriver		
	SDIS 0.6X3.5X100	9008390000
	SDS 0.6X3.5X100	9008330000

Ordering data

Solder pin length		3.2 mm	
Colour		Orange	
Pitch		5.08 mm	
Pol.	L1	(inch)	Qty. Order No.
2	5.08	0.200	100 1594400000
3	10.16	0.400	100 1594410000

Representative deratings curve

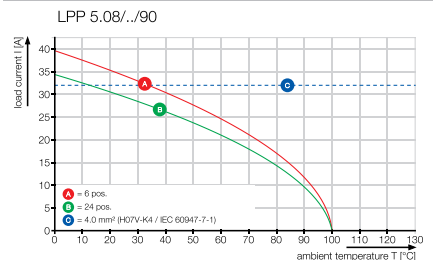

LP 5.08/./135

with test point



Dimensioned drawing

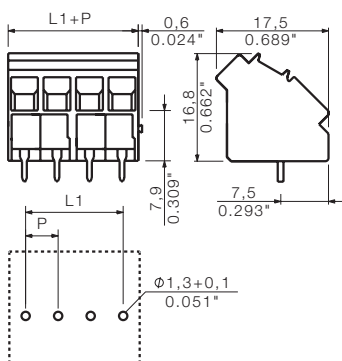

Ordering data

Solder pin length		3.2 mm		
Colour		Orange		
Pitch		5.08 mm		
Pol.	L1	(inch)	Qty.	Order No.
2	5.08	0.200	100	1595730000
3	10.16	0.400	100	1595690000
5	20.32	0.800	50	1843150000
6	25.40	1.000	50	1759360000
7	30.48	1.200	50	1843160000
8	35.56	1.400	50	1752940000
9	40.64	1.600	50	1843170000
10	45.72	1.800	50	1843180000
11	50.80	2.000	50	1843190000
12	55.88	2.200	50	1843200000

LP 5.08/./180



Dimensioned drawing

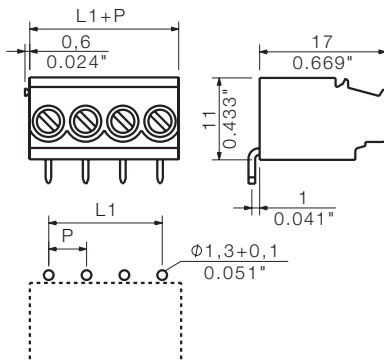

Ordering data

Solder pin length		3.2 mm		
Colour		Orange		
Pitch		5.08 mm		
Pol.	L1	(inch)	Qty.	Order No.
2	5.08	0.200	100	1753810000
3	10.16	0.400	100	1753820000

Additional deratings curves

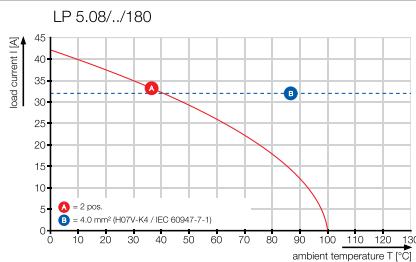
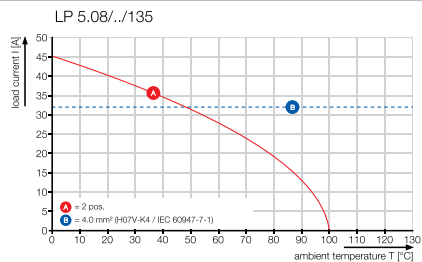

LP 5.00, multi level

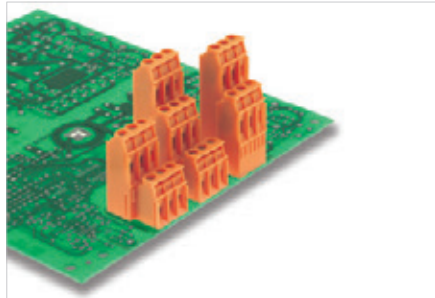

Multi-level PCB terminal with our proven clamping-yoke screw connection in 5.00 mm pitch, suitable for wire cross-sections up to 6 mm².

- Wire outlet direction of 90°.
- Block construction can be aligned together for higher pole counts.

Technical data

In compliance with IEC 60664-1 / IEC 61984		
Clamping range, max.	mm ²	0.13...6
Solid core H05(07) V-U	mm²	0.5...6
Stranded H07 V-R		
Flexible H05(07) V-K	mm ²	0.5...4
Flexible with ferrule	mm ²	0.5...2.5
Ferrule with plastic collar	mm ²	0.5...2.5
Stripping length	mm	6
Screwdriver blade	mm	0.6 x 3.5
According to norm		DIN 5264
Tightening torque range	Nm	0.5...0.6
Rated current, max.	A	32 32
At ambient temperature	20°C	40°C
For conductor cross-section	mm ²	2.5
Overtension category		III III II
Pollution severity		3 2 2
Rated voltage	V	250 250 500
Rated impulse voltage	kV	4 4 4
UL / CUL (Use Group)	B C D	B C D
Rated voltage	V	300 300
Rated current	A	20 10
AWG conductor	AWG	26-12
CSA (Use Group)	B C D	B C D
Rated voltage	V	300 300
Rated current	A	20 10
AWG conductor	AWG	26-12
General data		
Type of insulation material		PA
UL 94 flammability rating		V-2
Contact base material		Copper alloy
Material of contact surface		tinned
Pin dimensions = d	mm	0.75 x 0.9
Solder eyelet Ø = D	mm	1.3
Solder eyelet Ø tolerance	mm	+ 0,1

Product data

IEC: 500 V / 32 A / 0.5 - 6 mm²
 UL: 300 V / 20 A / AWG 26 - 12

For additional articles and information, refer to catalog.weidmueller.com

Note:

- Additional colours on request
- Rated current related to rated cross-section & min. No. of poles.
- Wire end ferrule without plastic collar to DIN 46228/1
- Wire end ferrule with plastic collar to DIN 46228/4
- P on drawing = pitch
- Rated data refer only to the component itself. Clearance and creepage distances to other components are to be designed in accordance with the relevant application standards.

LP1N 5.00/./90



Dimensioned drawing

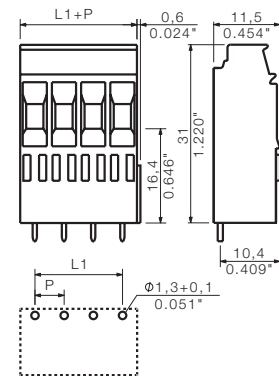

Ordering data

Solder pin length		3.2 mm		
Colour		Orange		
Pitch		5.00 mm		
Pol.	L1	(inch)	Qty.	Order No.
2	5.00	0.197	100	1640870000
3	10.00	0.394	100	1640880000

Accessories

Note: Refer to the Accessories chapter for additional accessories.

Marker holder and functional holder	Order No.
LPA BZ2	1497260000
LPA BZ3	1497360000
LPA FA2	1495960000
LPA FA2 BZ	1496160000
LPA FA3	1496060000
LPA FA3 BZ	1496260000
Cross-connection	
LPA QB 10	1472500000
LPA QB 17	1584770000
LPA QB 2	1472200000
LPA QB 24	1472600000
LPA QB 3	1472300000
LPA QB 4	1472400000
Screwdriver	
SDIS 0.6X3.5X100	9008390000
SDS 0.6X3.5X100	9008330000

Representative deratings curve

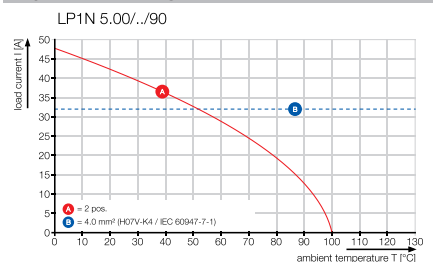

LP2N 5.00/./90



Dimensioned drawing

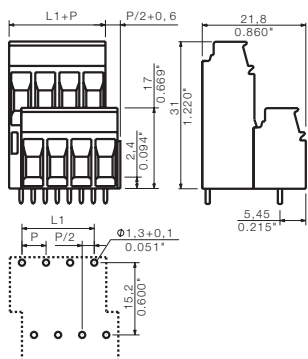

Ordering data

Solder pin length	3.2 mm		
Colour	Orange		
Pitch	5.00 mm		
Pol.	L1	(inch)	Qty. Order No.
4	5.00	0.197	50 1635160000
6	10.00	0.394	50 1625560000
8	15.00	0.591	50 1596450000
10	20.00	0.787	50 1596490000
16	35.00	1.378	20 1596550000
20	45.00	1.772	20 1596590000
24	55.00	2.165	10 1596630000
30	70.00	2.756	10 1596670000

Additional deratings curves

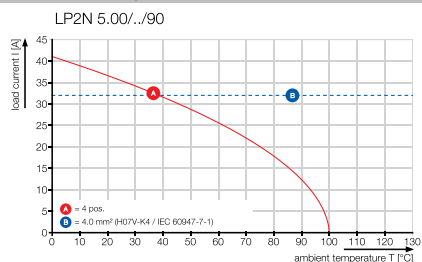

LP 5.08, multi level

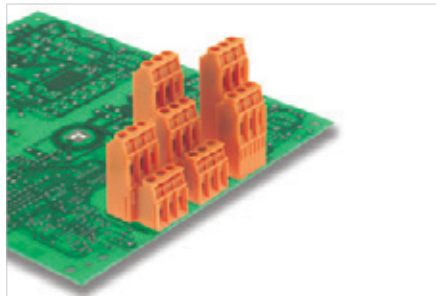

Multi-level PCB terminal with our proven clamping-yoke screw connection in 5.08 mm pitch, suitable for wire cross-sections up to 6 mm².

- Wire outlet direction of 90°. Block construction can be aligned together for higher pole counts.

Technical data

In compliance with IEC 60664-1 / IEC 61984			
Clamping range, max.	mm ²	0.13...6	
Solid core H05(07) V-U	mm²	0.5...6	
Stranded H07 V-R			
Flexible H05(07) V-K	mm ²	0.5...4	
Flexible with ferrule	mm ²	0.5...2.5	
Ferrule with plastic collar	mm ²	0.5...2.5	
Stripping length	mm	6	
Screwdriver blade	mm	0.6 x 3.5	
According to norm		DIN 5264	
Tightening torque range	Nm	0.5...0.6	
Rated current, max.	A	32	32
At ambient temperature		20°C	40°C
For conductor cross-section	mm ²	2.5	
Overvoltage category		III	III II
Pollution severity		3	2 2
Rated voltage	V	250	250 500
Rated impulse voltage	kV	4	4 4
UL / CUL (Use Group)		B	C D
Rated voltage	V	300	300
Rated current	A	20	10
AWG conductor	AWG	26-12	
CSA (Use Group)		B	C D
Rated voltage	V	300	300
Rated current	A	20	10
AWG conductor	AWG	26-12	
General data			
Type of insulation material		PA	
UL 94 flammability rating		V-2	
Contact base material		Copper alloy	
Material of contact surface		tinned	
Pin dimensions = d	mm	0.75 x 0.9	
Solder eyelet Ø = D	mm	1.3	
Solder eyelet Ø tolerance	mm	+ 0,1	

Product data

IEC: 500 V / 32 A / 0.5 - 6 mm²
 UL: 300 V / 20 A / AWG 26 - 12

For additional articles and information, refer to catalog.weidmueller.com

Note:

- Additional colours on request
- Rated current related to rated cross-section & min. No. of poles.
- Wire end ferrule without plastic collar to DIN 46228/1
- Wire end ferrule with plastic collar to DIN 46228/4
- P on drawing = pitch
- Rated data refer only to the component itself. Clearance and creepage distances to other components are to be designed in accordance with the relevant application standards.

LP1N 5.08/./90



Dimensioned drawing

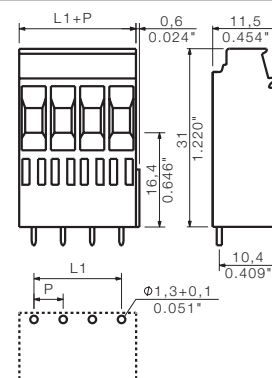

Ordering data

Solder pin length		3.2 mm		
Colour		Orange		
Pitch		5.08 mm		
Pol.	L1	(inch)	Qty.	Order No.
2	5.08	0.200	100	1640830000
3	10.16	0.400	100	1640840000

Accessories

Note: Refer to the Accessories chapter for additional accessories.

Marker holder and functional holder	Order No.
LPA BZ2	1497260000
LPA BZ3	1497360000
LPA FA2	1495960000
LPA FA2 BZ	1496160000
LPA FA3	1496060000
LPA FA3 BZ	1496260000
Cross-connection	
LPA QB 10	1472500000
LPA QB 17	1584770000
LPA QB 2	1472200000
LPA QB 24	1472600000
LPA QB 3	1472300000
LPA QB 4	1472400000
Screwdriver	
SDIS 0.6X3.5X100	9008390000
SDS 0.6X3.5X100	9008330000

Representative deratings curve

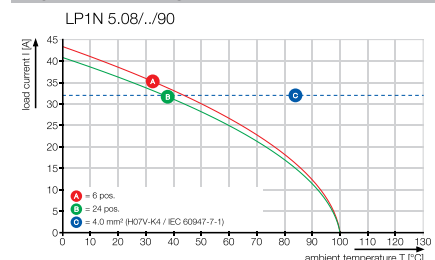

LP2N 5.08/./90



Dimensioned drawing

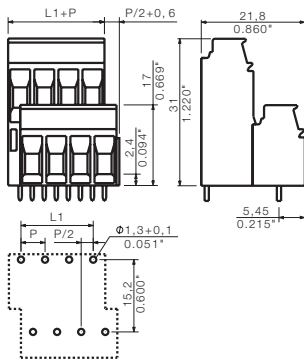

Ordering data

Solder pin length		3.2 mm			
Colour		Orange			
Pitch		5.08 mm			
Pol.	L1	(inch)	Qty.	Order No.	
4	5.08	0.200	50	1635140000	
6	10.16	0.400	50	1625540000	
8	15.24	0.600	50	1596460000	
10	20.32	0.800	50	1596510000	
12	25.40	1.000	50	1844510000	
14	30.48	1.200	50	1844520000	
16	35.56	1.400	20	1596530000	
18	40.64	1.600	20	1844530000	
20	45.72	1.800	20	1596570000	
22	50.80	2.000	20	1844540000	
24	55.88	2.200	10	1596610000	
26	60.96	2.400	10	1844550000	
28	66.04	2.600	10	1844560000	
30	71.12	2.800	10	1596650000	
32	76.20	3.000	10	1844570000	
34	81.28	3.200	10	1844580000	
36	86.36	3.400	10	1844590000	
38	91.44	3.600	10	1844600000	
40	96.52	3.800	10	1844610000	
42	101.60	4.000	10	1844620000	
44	106.68	4.200	10	1844630000	
46	111.76	4.400	10	1844640000	
48	116.84	4.600	10	1844650000	

LP1H 5.08/./90



Dimensioned drawing

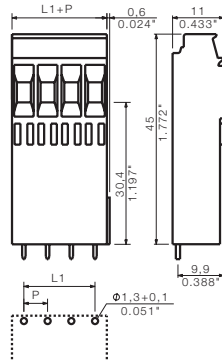

Ordering data

Solder pin length		3.2 mm			
Colour		Orange			
Pitch		5.08 mm			
Pol.	L1	(inch)	Qty.	Order No.	
2	5.08	0.200	100	1640910000	
3	10.16	0.400	100	1640920000	

LP2HR 5.08/./90



Dimensioned drawing

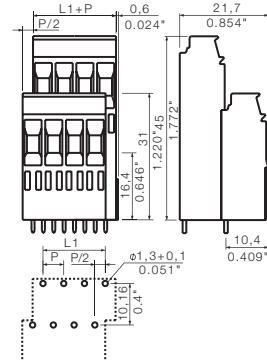

Ordering data

Solder pin length		3.2 mm			
Colour		Orange			
Pitch		5.08 mm			
Pol.	L1	(inch)	Qty.	Order No.	
4	5.08	0.200	50	1636210000	
6	10.16	0.400	50	1636220000	
8	15.24	0.600	50	1636230000	
10	20.32	0.800	50	1636240000	
12	25.40	1.000	20	1844660000	
14	30.48	1.200	20	1844670000	
16	35.56	1.400	20	1636250000	
18	40.64	1.600	20	1844680000	
20	45.72	1.800	20	1636260000	
24	55.88	2.200	10	1636270000	
26	60.96	2.400	10	1844690000	
28	66.04	2.600	10	1844700000	
30	71.12	2.800	10	1636280000	
32	76.20	3.000	10	1844710000	
34	81.28	3.200	10	1844720000	
36	86.36	3.400	10	1844730000	
38	91.44	3.600	10	1844740000	
40	96.52	3.800	10	1844750000	
42	101.60	4.000	10	1844760000	
44	106.68	4.200	10	1844770000	
46	111.76	4.400	10	1844780000	
48	116.84	4.600	10	1646480000	

Additional deratings curves

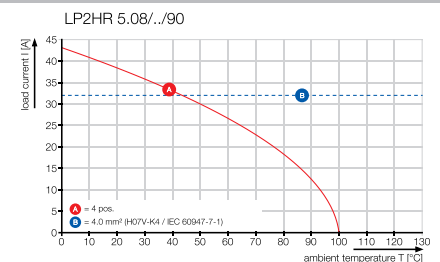
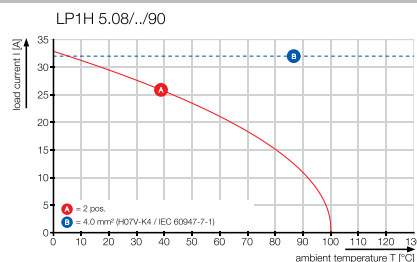
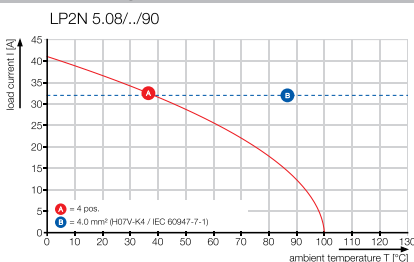

LP 5.08, multi level

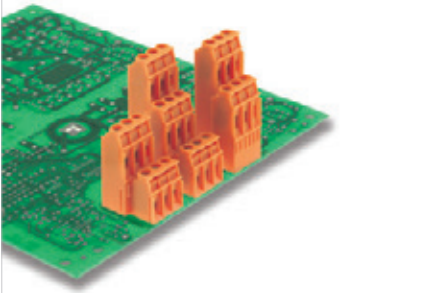

Multi-level PCB terminal with our proven clamping-yoke screw connection in 5.08 mm pitch, suitable for wire cross-sections up to 6 mm².

- Wire outlet direction of 90°. Block construction can be aligned together for higher pole counts.

Product data

IEC: 500 V / 32 A / 0.5 - 6 mm²
 UL: 300 V / 20 A / AWG 26 - 12

For additional articles and information, refer to catalog.weidmueller.com

Note:

- Additional colours on request
- Rated current related to rated cross-section & min. No. of poles.
- Wire end ferrule without plastic collar to DIN 46228/1
- Wire end ferrule with plastic collar to DIN 46228/4
- P on drawing = pitch
- Rated data refer only to the component itself. Clearance and creepage distances to other components are to be designed in accordance with the relevant application standards.

LP3R 5.08/./90



Dimensioned drawing

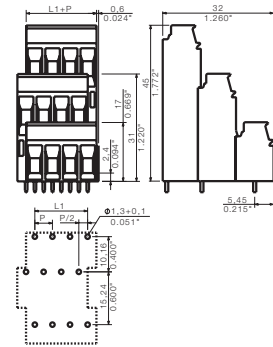



Technical data

In compliance with IEC 60664-1 / IEC 61984		
Clamping range, max.	mm ²	0.13...6
Solid core H05(07) V-U	mm ²	0.5...6
Stranded H07 V-R		
Flexible H05(07) V-K	mm ²	0.5...4
Flexible with ferrule	mm ²	0.5...2.5
Ferrule with plastic collar	mm ²	0.5...2.5
Stripping length	mm	6
Screwdriver blade	mm	0.6 x 3.5
According to norm		DIN 5264
Tightening torque range	Nm	0.5...0.6
Rated current, max.	A	32 30
At ambient temperature		20°C 40°C
For conductor cross-section	mm ²	2.5
Overvoltage category		III III II
Pollution severity		3 2 2
Rated voltage	V	250 250 500
Rated impulse voltage	kV	4 4 4
UL / CUL (Use Group)	B C D	D
Rated voltage	V	300 300
Rated current	A	20 10
AWG conductor	AWG	26-12
CSA (Use Group)	B C D	D
Rated voltage	V	300 300
Rated current	A	20 10
AWG conductor	AWG	26-12
General data		
Type of insulation material		PA
UL 94 flammability rating		V-2
Contact base material		Copper alloy
Material of contact surface		tinned
Pin dimensions = d	mm	0.75 x 0.9
Solder eyelet Ø = D	mm	1.3
Solder eyelet Ø tolerance	mm	+ 0,1

Accessories

Note: Refer to the Accessories chapter for additional accessories.

Marker holder and functional holder	Order No.
 LPA B22	1497260000
LPA BZ3	1497360000
LPA FA2	1495960000
LPA FA2 BZ	1496160000
LPA FA3	1496060000
LPA FA3 BZ	1496260000
Cross-connection	
LPA QB 10	1472500000
LPA QB 17	1584770000
LPA QB 2	1472200000
LPA QB 24	1472600000
LPA QB 3	1472300000
LPA QB 4	1472400000
Screwdriver	
 SDIS 0.6X3.5X100	9008390000
SDS 0.6X3.5X100	9008330000

Ordering data

Solder pin length		3.2 mm		
Colour		Orange		
Pitch		5.08 mm		
Pol.	L1	(inch)	Qty.	Order No.
6	5.08	0.200	50	1653930000
9	10.16	0.400	50	1596320000
12	15.24	0.600	50	1596340000
15	20.32	0.800	25	1596360000
18	25.40	1.000	25	1596380000
21	30.48	1.200	20	1844790000
24	35.56	1.400	20	1596400000
27	40.64	1.600	10	1844800000
30	45.72	1.800	10	1596420000
33	50.80	2.000	10	1844810000
36	55.88	2.200	10	1844820000
39	60.96	2.400	10	1844830000
42	66.04	2.600	10	1844840000
45	71.12	2.800	10	1844850000
48	76.20	3.000	10	1844860000
51	81.28	3.200	10	1844870000
54	86.36	3.400	10	1844880000
57	91.44	3.600	5	1844890000
60	96.52	3.800	5	1844900000
63	101.60	4.000	5	1844910000
66	106.68	4.200	5	1844920000
69	111.76	4.400	5	1844930000
72	116.84	4.600	5	1844940000

Representative deratings curve

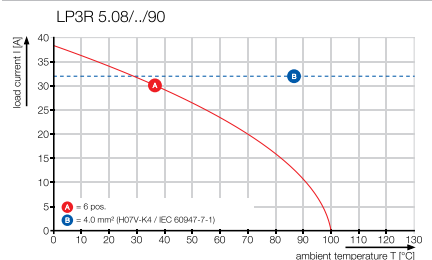

LP 5.08 partition

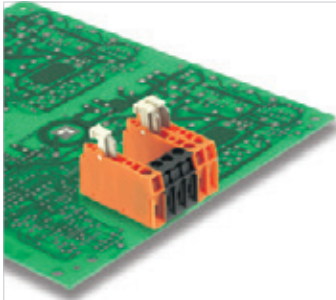

Isolating element with our proven clamping-yoke screw connection in 5.08 mm pitch, suitable for wire cross-sections up to 6.0 mm².

- Direction of wire outlet: 90° version with integrated test point for test plug PS 2.0.

Product data

IEC: 500 V / 32 A / 0.5 - 6 mm²
UL: 300 V / 15 A / AWG 26 - 12

For additional articles and information, refer to catalog.weidmueller.com

Note:

- Additional colours on request
- Rated current related to rated cross-section & min. No. of poles.
- Wire end ferrule without plastic collar to DIN 46228/1
- Wire end ferrule with plastic collar to DIN 46228/4
- P on drawing = pitch
- Rated data refer only to the component itself. Clearance and creepage distances to other components are to be designed in accordance with the relevant application standards.

LPTR 5.08/./90



Dimensioned drawing

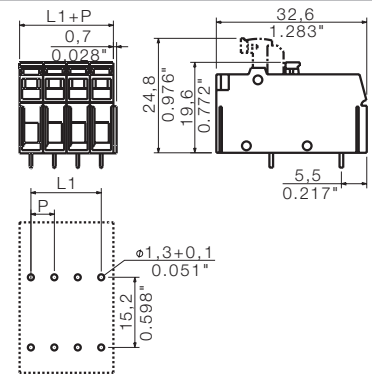



Technical data

In compliance with IEC 60664-1 / IEC 61984

Clamping range, max.	mm ²	0.13...6
Solid core H05(07) V-U	mm²	0.5...6
Stranded H07 V-R		
Flexible H05(07) V-K	mm ²	0.5...4
Flexible with ferrule	mm ²	0.5...2.5
Ferrule with plastic collar	mm ²	0.5...2.5
Stripping length	mm	6
Screwdriver blade	mm	0.6 x 3.5
According to norm		DIN 5264
Tightening torque range	Nm	0.5...0.6
Rated current, max.	A	32 32
At ambient temperature	20°C	40°C
For conductor cross-section	mm ²	2.5
Overtoltage category		III III II
Pollution severity		3 2 2
Rated voltage	V	250 250 500
Rated impulse voltage	kV	4 4 4
UL / CUL (Use Group)	B C D	
Rated voltage	V	300 300
Rated current	A	15 10
AWG conductor	AWG	26-12
CSA (Use Group)	B C D	
Rated voltage	V	300 300
Rated current	A	15 10
AWG conductor	AWG	26-12
General data		
Type of insulation material		PA
UL 94 flammability rating		V-2
Contact base material		Copper alloy
Material of contact surface		tinned
Pin dimensions = d	mm	0.75 x 0.9
Solder eyelet Ø = D	mm	1.3
Solder eyelet Ø tolerance	mm	+ 0,1

Accessories

Note: Refer to the Accessories chapter for additional accessories.

Screwdriver		Order No.
	SDIS 0.6X3.5X100	9008390000
	SDS 0.6X3.5X100	9008330000
Test plug		
	PS 2.0 MC	0310000000

Ordering data

Solder pin length	3.2 mm			
Colour	Orange			
Pitch	5.08 mm			
Pol.	L1	(inch)	Qty.	Order No.
1	0.00	0.000	100	1755180000

Representative deratings curve

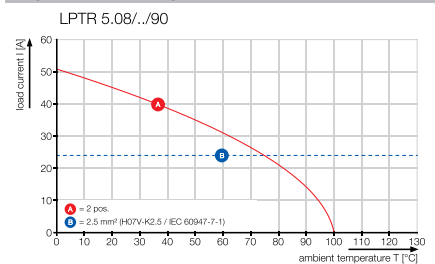

LP 7.50

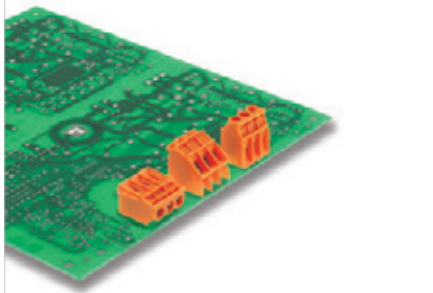

Single-row PCB terminal with our proven clamping-yoke screw connection in 7.50 mm pitch, suitable for wire cross-sections up to 6.0 mm².

- Wire outlet direction: 90°, 135° and 180° versions.
- 90° and 135° versions optionally with integrated test point for test plug PS 2.0.
- Version with a wide variety of extra functions.
- 2- and 3-pole block construction can be aligned together for higher pole counts.

Technical data

In compliance with IEC 60664-1 / IEC 61984		
Clamping range, max.	mm ²	0.13...6
Solid core H05(07) V-U	mm²	0.5...6
Stranded H07 V-R		...6
Flexible H05(07) V-K	mm ²	0.5...4
Flexible with ferrule	mm ²	0.5...2.5
Ferrule with plastic collar	mm ²	0.5...2.5
Stripping length	mm	6
Screwdriver blade	mm	0.6 x 3.5
According to norm		DIN 5264
Tightening torque range	Nm	0.5...0.6
Rated current, max.	A	32 32
At ambient temperature		20°C 40°C
For conductor cross-section	mm ²	2.5
Overtoltage category		III III II
Pollution severity		3 2 2
Rated voltage	V	500 500 1000
Rated impulse voltage	kV	6 6 6
UL / CUL (Use Group)	B C D	B C D
Rated voltage	V	300 300
Rated current	A	20 10
AWG conductor	AWG	26-12
CSA (Use Group)	B C D	B C D
Rated voltage	V	300 300
Rated current	A	20 10
AWG conductor	AWG	26-12
General data		
Type of insulation material		PA
UL 94 flammability rating		V-2
Contact base material		Copper alloy
Material of contact surface		tinned
Pin dimensions = d	mm	0.75 x 0.9
Solder eyelet Ø = D	mm	1.3
Solder eyelet Ø tolerance	mm	+ 0,1

Product data

IEC: 1000 V / 32 A / 0.5 - 6 mm²
 UL: 300 V / 20 A / AWG 26 - 12

For additional articles and information, refer to catalog.weidmueller.com

Note:

- Additional colours on request
- Rated current related to rated cross-section & min. No. of poles.
- Wire end ferrule without plastic collar to DIN 46228/1
- Wire end ferrule with plastic collar to DIN 46228/4
- P on drawing = pitch
- Rated data refer only to the component itself. Clearance and creepage distances to other components are to be designed in accordance with the relevant application standards.

LP 7.5/./90



Dimensioned drawing

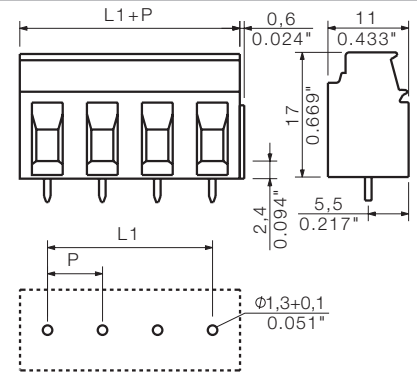

Ordering data

Solder pin length		3.2 mm	
Colour		Orange	
Pitch		7.50 mm	
Pol.	L1	(inch)	Qty. Order No.
2	7.50	0.295	100 1594420000
3	15.00	0.591	100 1594430000

Accessories

Note: Refer to the Accessories chapter for additional accessories.

Screwdriver		Order No.
	SDIS 0.6X3.5X100	9008390000
	SDS 0.6X3.5X100	9008330000

Representative deratings curve

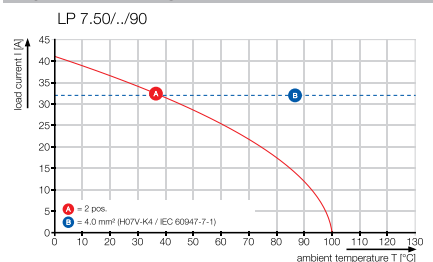

LPP 7.50../90

with test point



Dimensioned drawing

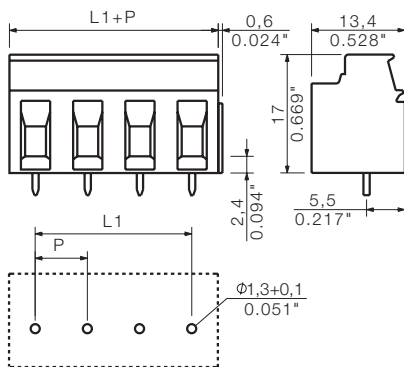

Ordering data

Solder pin length		3.2 mm		
Colour		Orange		
Pitch		7.50 mm		
Pol.	L1	(inch)	Qty.	Order No.
2	7.50	0.295	100	1594440000
3	15.00	0.591	100	1594450000

LP 7.50../135

with test point



Dimensioned drawing

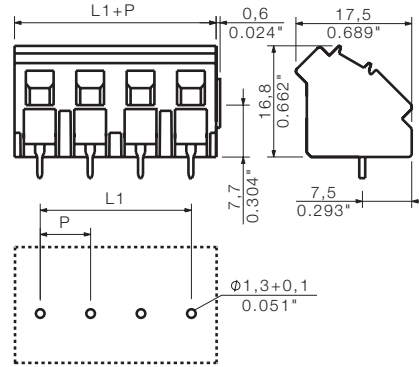

Ordering data

Solder pin length		3.2 mm		
Colour		Orange		
Pitch		7.50 mm		
Pol.	L1	(inch)	Qty.	Order No.
2	7.50	0.295	100	1595770000
3	15.00	0.591	100	1595810000

LP 7.50../180

with test point



Dimensioned drawing

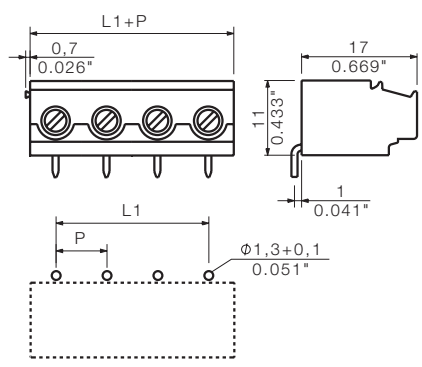

Ordering data

Solder pin length		3.2 mm		
Colour		Orange		
Pitch		7.50 mm		
Pol.	L1	(inch)	Qty.	Order No.
2	7.50	0.295	100	1761370000
3	15.00	0.591	100	1761380000

Additional deratings curves

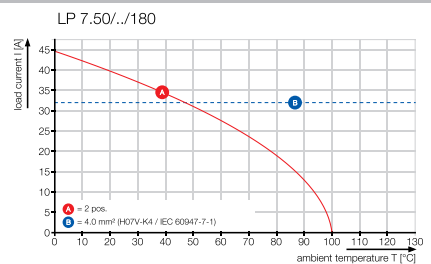
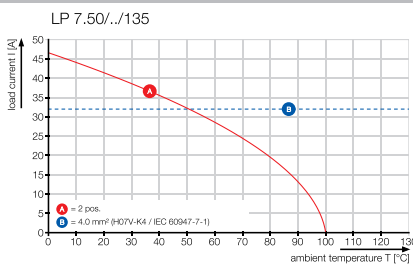
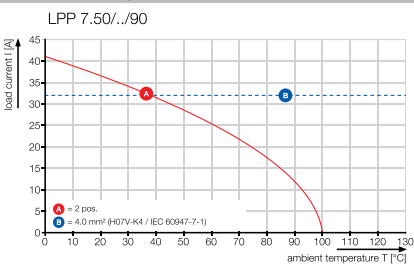

LP 7.62

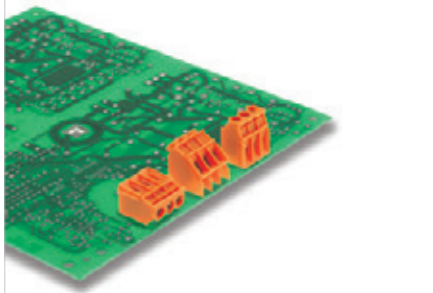

Single-row PCB terminal with our proven clamping-yoke screw connection in 7.62 mm pitch, suitable for wire cross-sections up to 6.0 mm².

- Wire outlet direction: 90°, 135° and 180° versions.
- 90° and 135° versions optionally with integrated test point for test plug PS 2.0.
- Version with a wide variety of extra functions.
- 2- and 3-pole block construction can be aligned together for higher pole counts.

Technical data

In compliance with IEC 60664-1 / IEC 61984		
Clamping range, max.	mm ²	0.13...6
Solid core H05(07) V-U	mm²	0.5...6
Stranded H07 V-R		...6
Flexible H05(07) V-K	mm ²	0.5...4
Flexible with ferrule	mm ²	0.5...2.5
Ferrule with plastic collar	mm ²	0.5...2.5
Stripping length	mm	6
Screwdriver blade	mm	0.6 x 3.5
According to norm		DIN 5264
Tightening torque range	Nm	0.5...0.6
Rated current, max.	A	32 32
At ambient temperature		20°C 40°C
For conductor cross-section	mm ²	2.5
Overtoltage category		III III II
Pollution severity		3 2 2
Rated voltage	V	500 500 1000
Rated impulse voltage	kV	6 6 6
UL / CUL (Use Group)	B C D	B C D
Rated voltage	V	300 300
Rated current	A	20 10
AWG conductor	AWG	26-12
CSA (Use Group)	B C D	B C D
Rated voltage	V	300 300
Rated current	A	20 10
AWG conductor	AWG	26-12
General data		
Type of insulation material		PA
UL 94 flammability rating		V-2
Contact base material		Copper alloy
Material of contact surface		tinned
Pin dimensions = d	mm	0.75 x 0.9
Solder eyelet Ø = D	mm	1.3
Solder eyelet Ø tolerance	mm	+ 0,1

Product data

IEC: 1000 V / 32 A / 0.5 - 6 mm²
 UL: 300 V / 20 A / AWG 26 - 12

For additional articles and information, refer to catalog.weidmueller.com

Note:

- Additional colours on request
- Rated current related to rated cross-section & min. No. of poles.
- Wire end ferrule without plastic collar to DIN 46228/1
- Wire end ferrule with plastic collar to DIN 46228/4
- P on drawing = pitch
- Rated data refer only to the component itself. Clearance and creepage distances to other components are to be designed in accordance with the relevant application standards.

LP 7.62/./90



Dimensioned drawing

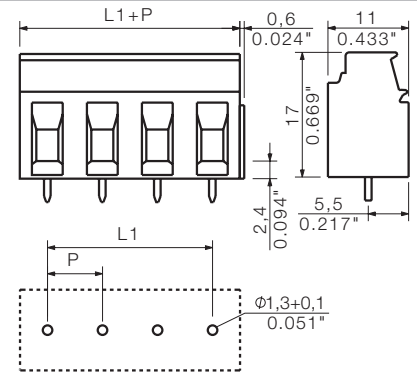

Ordering data

Solder pin length		3.2 mm	
Colour		Orange	
Pitch		7.62 mm	
Pol.	L1	(inch)	Qty. Order No.
2	7.62	0.300	100 1594460000
3	15.24	0.600	100 1594470000

Accessories

Note: Refer to the Accessories chapter for additional accessories.

Screwdriver		Order No.
	SDIS 0.6X3.5X100	9008390000
	SDS 0.6X3.5X100	9008330000

Representative deratings curve

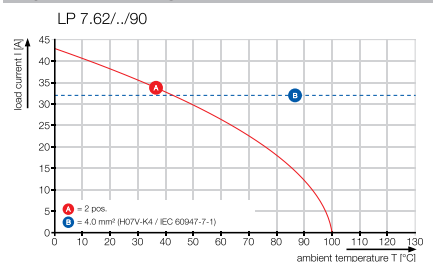

LPP 7.62/./90

with test point



Dimensioned drawing

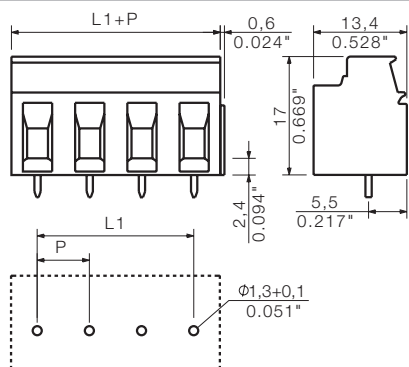

Ordering data

Solder pin length		3.2 mm		
Colour		Orange		
Pitch		7.62 mm		
Pol.	L1	(inch)	Qty.	Order No.
2	7.62	0.300	100	1594480000
3	15.24	0.600	100	1594490000

LP 7.62/./135

with test point



Dimensioned drawing

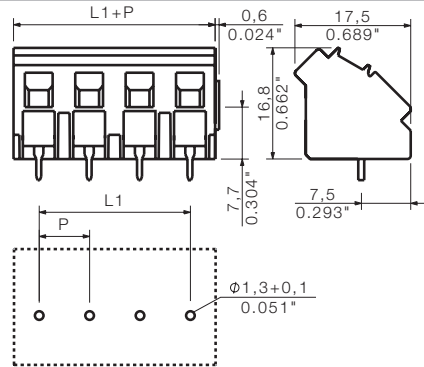

Ordering data

Solder pin length		3.2 mm		
Colour		Orange		
Pitch		7.62 mm		
Pol.	L1	(inch)	Qty.	Order No.
2	7.62	0.300	100	1595790000
3	15.24	0.600	100	1595830000

LP 7.62/./180

with test point



Dimensioned drawing

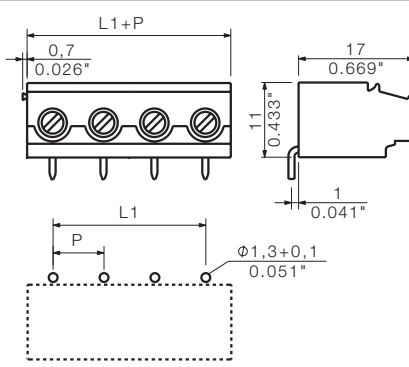

Ordering data

Solder pin length		3.2 mm		
Colour		Orange		
Pitch		7.62 mm		
Pol.	L1	(inch)	Qty.	Order No.
2	7.62	0.300	100	1753890000
3	15.24	0.600	100	1753900000

Additional deratings curves

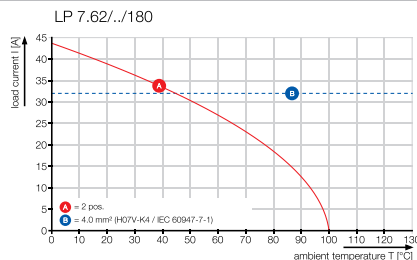
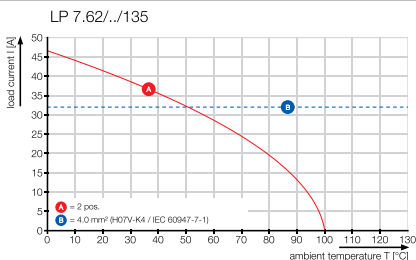
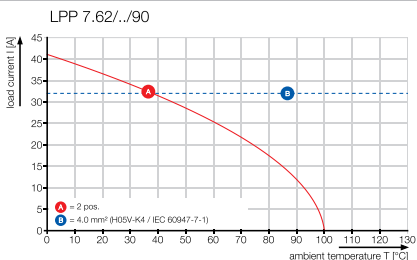

LL 5.00 & LL 5.08

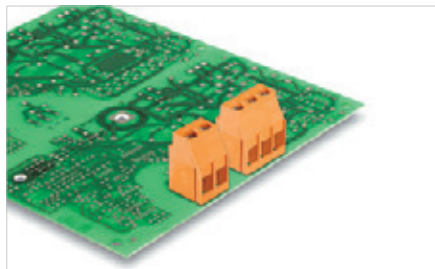

Single-row PCB terminal with our proven clamping-yoke screw connection in 5.00 and 5.08 mm pitches, suitable for wire cross-sections up to 6.0 mm².

- Increased derating reserves because WEMID insulating material is used.
- Wire outlet direction of 90°.
- 2- and 3-pole block construction can be aligned together for higher pole counts.

Technical data

In compliance with IEC 60664-1 / IEC 61984			
Clamping range, max.	mm ²	0.08...6	
Solid core H05(07) V-U	mm²	0.5...6	
Stranded H07 V-R			
Flexible H05(07) V-K	mm ²	0.5...4	
Flexible with ferrule	mm ²	0.5...2.5	
Ferrule with plastic collar	mm ²	0.5...2.5	
Stripping length	mm	6	
Screwdriver blade	mm	0.6 x 3.5	
According to norm		DIN 5264	
Tightening torque range	Nm	0.5...0.6	
Rated current, max.	A	32.5	27.5
At ambient temperature		20°C	40°C
For conductor cross-section	mm ²	2.5	
Overtoltage category		III	III II
Pollution severity		3	2 2
Rated voltage	V	250	320 500
Rated impulse voltage	kV	4	4 4
UL / CUL (Use Group)	B C D	B	C D
Rated voltage	V	300	300
Rated current	A	20	10
AWG conductor	AWG	28-12	
CSA (Use Group)	B C D	B	C D
Rated voltage	V	300	300
Rated current	A	20	10
AWG conductor	AWG	28-12	
General data			
Type of insulation material		Wemid (PA)	
UL 94 flammability rating		V-0	
Contact base material		Copper alloy	
Material of contact surface		tinned	
Pin dimensions = d	mm	0.75 x 0.9	
Solder eyelet Ø = D	mm	1.3	
Solder eyelet Ø tolerance	mm	+ 0,1	

Product data

IEC: 500 V / 32.5 A / 0.5 - 6 mm²
 UL: 300 V / 20 A / AWG 28 - 12

For additional articles and information, refer to catalog.weidmueller.com

Note:

- Rated current related to rated cross-section & min. No. of poles.
- Wire end ferrule without plastic collar to DIN 46228/1
- Wire end ferrule with plastic collar to DIN 46228/4
- P on drawing = pitch
- Rated data refer only to the component itself. Clearance and creepage distances to other components are to be designed in accordance with the relevant application standards.

LL 5.00/./90



Dimensioned drawing

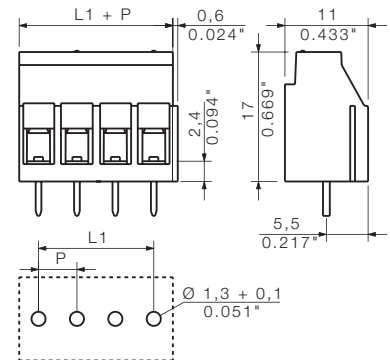

Ordering data

Solder pin length		3.2 mm		
Colour		Orange		
Pitch	5.00 mm			
Pol.	L1	(inch)	Qty.	Order No.
2	5.00	0.197	100	1934270000
3	10.00	0.394	100	1934280000
4	15.00	0.591	100	1001720000
5	20.00	0.788	50	1001730000
6	25.00	0.985	50	1001740000
7	30.00	1.182	50	1001750000
8	35.00	1.379	50	1001760000
9	40.00	1.576	50	1001770000
10	45.00	1.773	50	1001780000
11	50.00	1.970	50	1001790000
12	55.00	2.167	50	1001800000
13	60.00	2.364	50	1251330000
14	65.00	2.561	50	1001810000
15	70.00	2.758	50	1251340000
16	75.00	2.955	50	1001820000
17	80.00	3.152	20	1251350000
18	85.00	3.349	20	1251360000
19	90.00	3.546	20	1251370000
20	95.00	3.743	20	1251380000
21	100.00	3.940	20	1251390000
22	105.00	4.137	20	1251410000
23	110.00	4.334	20	1251420000
24	115.00	4.531	20	1001830000

Representative deratings curve

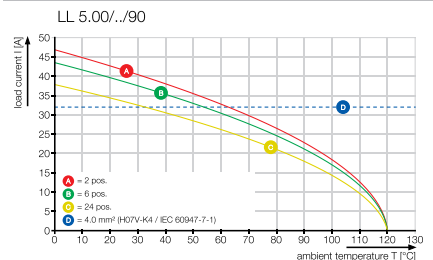

Accessories

Note: Refer to the Accessories chapter for additional accessories.

Screwdriver		Order No.
	SDIS 0.6X3.5X100	9008390000
	SDS 0.6X3.5X100	9008330000

LL 5.08/./90



Dimensioned drawing

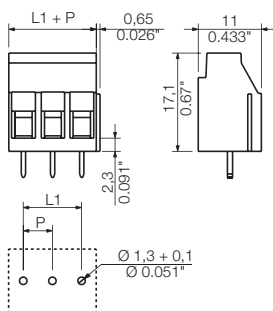

Ordering data

Solder pin length		3.2 mm		
Colour		Orange		
Pitch		5.08 mm		
Pol.	L1	(inch)	Qty.	Order No.
2	5.08	0.200	100	1934250000
3	10.16	0.400	100	1934260000
4	15.24	0.600	100	1001850000
5	20.32	0.800	50	1001860000
6	25.40	1.000	50	1001870000
7	30.48	1.200	50	1001880000
8	35.56	1.400	50	1001890000
9	40.64	1.600	50	1001900000
10	45.72	1.800	50	1001910000
11	50.80	2.000	50	1001920000
12	55.88	2.200	50	1001930000
13	60.96	2.400	50	1001940000
14	66.04	2.600	50	1001950000
15	71.12	2.800	50	1001960000
16	76.20	3.000	50	1001970000
17	81.28	3.200	20	1001980000
18	86.36	3.400	20	1001990000
19	91.44	3.600	20	1002000000
20	96.52	3.800	20	1002010000
21	101.60	4.000	20	1002020000
22	106.68	4.200	20	1002030000
23	111.76	4.400	20	1002040000
24	116.84	4.600	20	1002050000

Additional deratings curves

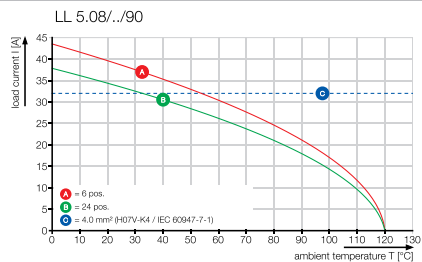

LL 5.00, multi level

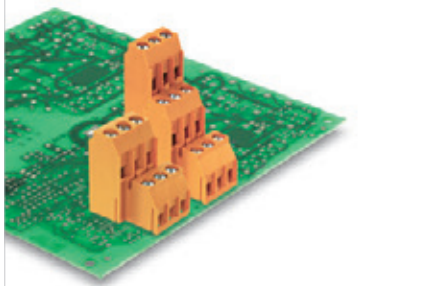

Multi-level PCB terminal with our proven clamping-yoke screw connection in 5.00 mm pitch, suitable for wire cross-sections up to 6 mm².

- Increased derating reserves because WEMID insulating material is used.
- Wire outlet direction of 90°.
- Block construction can be aligned together for higher pole counts.

Technical data

In compliance with IEC 60664-1 / IEC 61984			
Clamping range, max.	mm ²	0.08...6	
Solid core H05(07) V-U	mm ²	0.5...6	
Stranded H07 V-R			
Flexible H05(07) V-K	mm ²	0.5...4	
Flexible with ferrule	mm ²	0.5...2.5	
Ferrule with plastic collar	mm ²	0.5...2.5	
Stripping length	mm	6	
Screwdriver blade	mm	0.6 x 3.5	
According to norm		DIN 5264	
Tightening torque range	Nm	0.5...0.6	
Rated current, max.	A	32.5	27.5
At ambient temperature		20°C	40°C
For conductor cross-section	mm ²	2.5	
Overtoltage category		III	III II
Pollution severity		3	2 2
Rated voltage	V	250	320 500
Rated impulse voltage	kV	4	4 4
UL / CUL (Use Group)		B	C D
Rated voltage	V	300	300
Rated current	A	20	10
AWG conductor	AWG	28-12	
CSA (Use Group)		B	C D
Rated voltage	V	300	300
Rated current	A	20	10
AWG conductor	AWG	28-12	
General data			
Type of insulation material		Wemid (PA)	
UL 94 flammability rating		V-0	
Contact base material		Copper alloy	
Material of contact surface		tinned	
Pin dimensions = d	mm	0.75 x 0.9	
Solder eyelet Ø = D	mm	1.3	
Solder eyelet Ø tolerance	mm	+ 0,1	

Product data

IEC: 500 V / 32.5 A / 0.5 - 6 mm²
 UL: 300 V / 20 A / AWG 28 - 12

For additional articles and information, refer to catalog.weidmueller.com

Note:

- Rated current related to rated cross-section & min. No. of poles.
- Wire end ferrule without plastic collar to DIN 46228/1
- Wire end ferrule with plastic collar to DIN 46228/4
- P on drawing = pitch
- Rated data refer only to the component itself. Clearance and creepage distances to other components are to be designed in accordance with the relevant application standards.

LL1N 5.00/.. /90



Dimensioned drawing

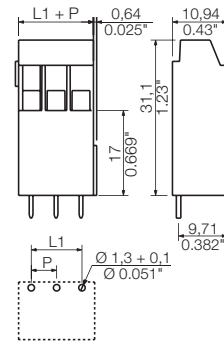

Accessories

Note: Refer to the Accessories chapter for additional accessories.

Screwdriver	Order No.
 SDIS 0.6X3.5X100	9008390000
SDS 0.6X3.5X100	9008330000

Ordering data

Solder pin length		3.2 mm		
Colour		Orange		
Pitch		5.00 mm		
Pol.	L1	(inch)	Qty.	Order No.
2	5.00	0.197	100	1975250000
3	10.00	0.394	100	1975260000
4	15.00	0.591	100	1975270000
5	20.00	0.788	50	1975280000
6	25.00	0.985	50	1975290000
7	30.00	1.182	50	1975300000
8	35.00	1.379	50	1975310000
9	40.00	1.576	50	1975320000
10	45.00	1.773	50	1975330000
11	50.00	1.970	50	1975340000
12	55.00	2.167	50	1975350000

Representative deratings curve

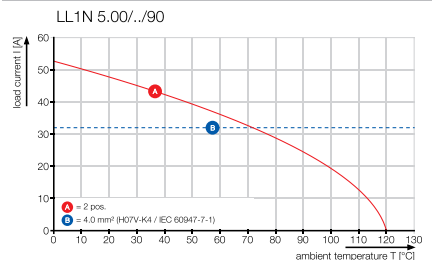

LL2N 5.00/./90



Dimensioned drawing

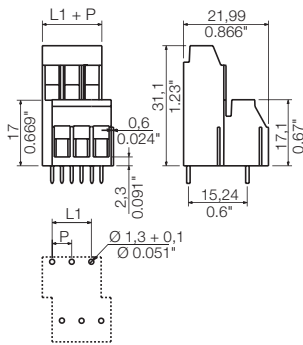

LL3R 5.00/./90



Dimensioned drawing

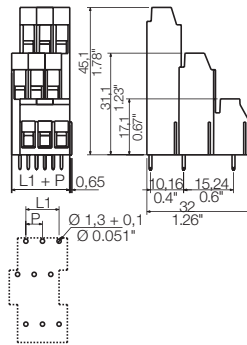

Ordering data

Solder pin length		3.2 mm		
Colour		Orange		
Pitch		5.00 mm		
Pol.	L1	(inch)	Qty.	Order No.
4	10.00	0.197	50	1934310000
8	15.00	0.591	50	1977260000
12	25.00	0.985	50	1977280000
16	35.00	1.379	20	1977310000
20	45.00	1.773	20	1977330000
24	55.00	2.167	10	1977350000
28	65.00	2.561	10	1977370000
32	75.00	2.955	10	1977390000
36	85.00	3.349	10	1977410000
40	95.00	3.743	10	1977430000
44	105.00	4.137	10	1977450000
48	115.00	4.531	10	1977470000

Ordering data

Solder pin length		3.2 mm		
Colour		Orange		
Pitch		5.00 mm		
Pol.	L1	(inch)	Qty.	Order No.
6	5.00	0.197	50	1934360000
12	15.00	0.591	50	1978850000
18	25.00	0.985	25	1978870000
24	35.00	1.379	20	1978890000
30	45.00	1.773	10	1978910000
36	55.00	2.167	10	1978930000
42	65.00	2.561	10	1978950000
48	75.00	2.955	10	1978970000
54	85.00	3.349	10	1978990000
60	95.00	3.743	5	1979010000
66	105.00	4.137	5	1979030000
72	115.00	4.531	5	1979050000

Additional deratings curves

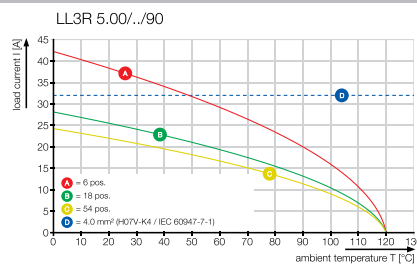
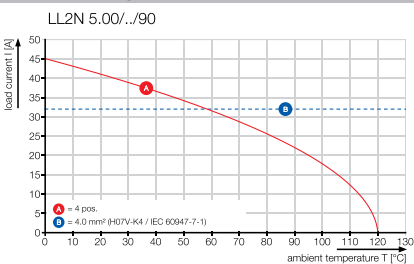

LL 5.08, multi level

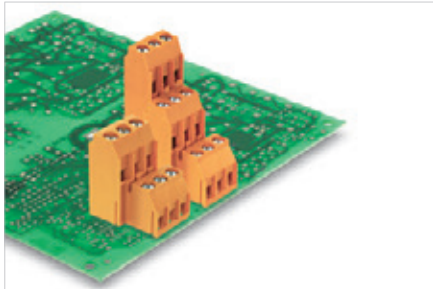

Multi-level PCB terminal with our proven clamping-yoke screw connection in 5.08 mm pitch, suitable for wire cross-sections up to 6 mm².

- Increased derating reserves because WEMID insulating material is used.
- Wire outlet direction of 90°.
- Block construction can be aligned together for higher pole counts.

Technical data

In compliance with IEC 60664-1 / IEC 61984			
Clamping range, max.	mm ²	0.08...6	
Solid core H05(07) V-U	mm ²	0.5...6	
Stranded H07 V-R			
Flexible H05(07) V-K	mm ²	0.5...4	
Flexible with ferrule	mm ²	0.5...2.5	
Ferrule with plastic collar	mm ²	0.5...2.5	
Stripping length	mm	6	
Screwdriver blade	mm	0.6 x 3.5	
According to norm		DIN 5264	
Tightening torque range	Nm	0.5...0.6	
Rated current, max.	A	32.5	27.5
At ambient temperature		20°C	40°C
For conductor cross-section	mm ²	2.5	
Overtoltage category		III	III II
Pollution severity		3	2 2
Rated voltage	V	250	320 500
Rated impulse voltage	kV	4	4 4
UL / CUL (Use Group)		B	C D
Rated voltage	V	300	300
Rated current	A	20	10
AWG conductor	AWG	28-12	
CSA (Use Group)		B	C D
Rated voltage	V	300	300
Rated current	A	20	10
AWG conductor	AWG	28-12	
General data			
Type of insulation material		Wemid (PA)	
UL 94 flammability rating		V-0	
Contact base material		Copper alloy	
Material of contact surface		tinned	
Pin dimensions = d	mm	0.75 x 0.9	
Solder eyelet Ø = D	mm	1.3	
Solder eyelet Ø tolerance	mm	+ 0,1	

Product data

IEC: 500 V / 32.5 A / 0.5 - 6 mm²
 UL: 300 V / 20 A / AWG 28 - 12

For additional articles and information, refer to catalog.weidmueller.com

Note:

- Rated current related to rated cross-section & min. No. of poles.
- Wire end ferrule without plastic collar to DIN 46228/1
- Wire end ferrule with plastic collar to DIN 46228/4
- P on drawing = pitch
- Rated data refer only to the component itself. Clearance and creepage distances to other components are to be designed in accordance with the relevant application standards.

LL1N 5.08../90



Dimensioned drawing

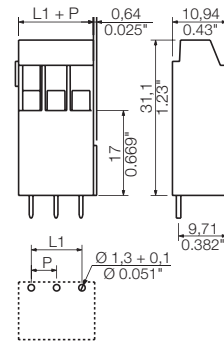

Accessories

Note: Refer to the Accessories chapter for additional accessories.

Screwdriver	Order No.
 SDIS 0.6X3.5X100	9008390000
SDS 0.6X3.5X100	9008330000

Ordering data

Solder pin length					3.2 mm
Colour					Orange
Pitch 5.08 mm					
Pol.	L1	(inch)	Qty.	Order No.	
2	5.08	0.200	100	1975360000	
3	10.16	0.400	100	1975370000	
4	15.24	0.600	100	1975380000	
5	20.32	0.800	50	1975390000	
6	25.40	1.000	50	1975400000	
7	30.48	1.200	50	1975410000	
8	35.56	1.400	50	1975420000	
9	40.64	1.600	50	1975430000	
10	45.72	1.800	50	1975440000	
11	50.80	2.000	50	1975460000	
12	55.88	2.200	50	1975470000	

Representative deratings curve

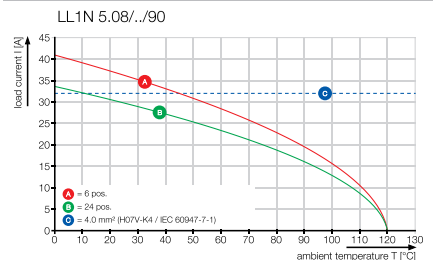

LL2N 5.08/./90



Dimensioned drawing

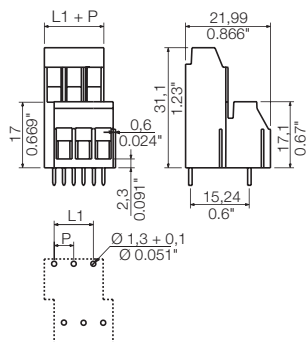

Ordering data

Solder pin length		3.2 mm			
Colour		Orange			
Pitch		5.08 mm			
Pol.	L1	(inch)	Qty.	Order No.	
8	15.24	0.600	50	1977480000	
12	25.40	1.000	50	1977500000	
16	35.56	1.400	20	1977520000	
20	45.72	1.800	20	1977540000	
24	55.88	2.200	10	1977560000	
28	66.04	2.600	10	1977580000	
32	76.20	3.000	10	1977600000	
36	86.36	3.400	10	1977620000	
40	96.52	3.800	10	1977640000	
44	106.68	4.200	10	1977660000	
48	116.84	4.600	10	1977680000	

LL3R 5.08/./90



Dimensioned drawing

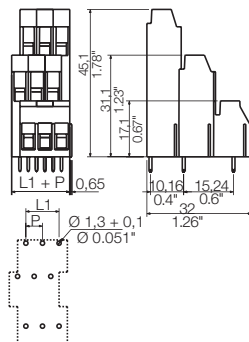

Ordering data

Solder pin length		3.2 mm			
Colour		Orange			
Pitch		5.08 mm			
Pol.	L1	(inch)	Qty.	Order No.	
6	5.08	0.200	50	1934340000	
12	15.24	0.600	50	1979060000	
18	25.40	1.000	25	1979080000	
24	35.56	1.400	20	1979100000	
30	45.72	1.800	10	1979120000	
36	55.88	2.200	10	1979140000	
42	66.04	2.600	10	1979160000	
48	76.20	3.000	10	1979180000	
54	86.36	3.400	10	1979200000	
60	96.52	3.800	5	1979220000	
66	106.68	4.200	5	1979240000	
72	116.84	4.600	5	1979260000	

Additional deratings curves

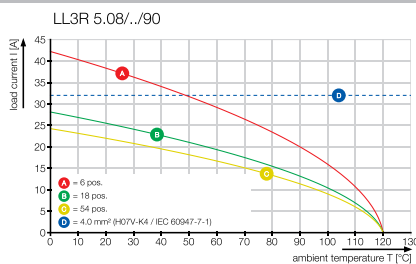
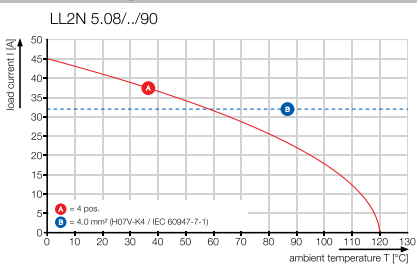

LL 9.52

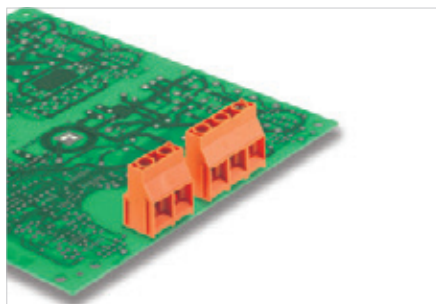

Single-row PCB terminal with our proven clamping-yoke screw connection in 9.52 mm pitch, suitable for wire cross-sections up to 6 mm².

- Increased derating reserves because WEMID insulating material is used.
- Wire outlet direction of 90°.
- 2- and 3-pole block construction can be aligned together for higher pole counts.

Technical data

In compliance with IEC 60664-1 / IEC 61984		
Clamping range, max.	mm ²	0.18...6
Solid core H05(07) V-U	mm²	0.18...6
Stranded H07 V-R		
Flexible H05(07) V-K	mm ²	0.22...4
Flexible with ferrule	mm ²	0.5...4
Ferrule with plastic collar	mm ²	0.5...2.5
Stripping length	mm	7
Screwdriver blade	mm	0.8 x 4.0
According to norm		DIN 5264
Tightening torque range	Nm	0.5...0.6
Rated current, max.	A	32 32
At ambient temperature		20°C 40°C
For conductor cross-section	mm ²	4
Overtoltage category		III III II
Pollution severity		3 2 2
Rated voltage	V	690 1000 1000
Rated impulse voltage	kV	8 8 6
UL / CUL (Use Group)	B C D	B C D
Rated voltage	V	300 300
Rated current	A	30 30
AWG conductor	AWG	26-10
CSA (Use Group)	B C D	B C D
Rated voltage	V	300 300
Rated current	A	30 35
AWG conductor	AWG	26-10
General data		
Type of insulation material		Wemid (PA)
UL 94 flammability rating		V-0
Contact base material		Copper alloy
Material of contact surface		tinned
Pin dimensions = d	mm	0.5 x 1.0
Solder eyelet Ø = D	mm	1.3
Solder eyelet Ø tolerance	mm	+ 0,1

Product data

IEC: 1000 V / 32 A / 0.18 - 6 mm²
 UL: 300 V / 30 A / AWG 26 - 10

For additional articles and information, refer to catalog.weidmueller.com

Note:

- Rated current related to rated cross-section & min. No. of poles.
- Wire end ferrule without plastic collar to DIN 46228/1
- Wire end ferrule with plastic collar to DIN 46228/4
- P on drawing = pitch
- Rated data refer only to the component itself. Clearance and creepage distances to other components are to be designed in accordance with the relevant application standards.

LL 9.52/. /90



Dimensioned drawing

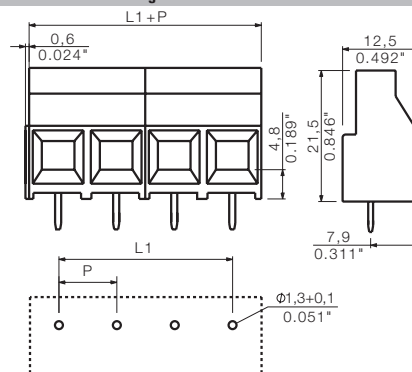

Accessories

Note: Refer to the Accessories chapter for additional accessories.

Screwdriver		Order No.
	SDIS 0.8X4.0X100	9008400000
	SDS 0.8X4.0X100	9008340000
Crosshead screwdriver		
	SDK PZ1	9008530000

Ordering data

Solder pin length		5 mm		
Colour		Orange		
Pitch		9.52 mm		
Pol.	L1	(inch)	Qty.	Order No.
2	9.52	0.375	100	1724680000
3	19.04	0.750	100	1724690000

Representative deratings curve

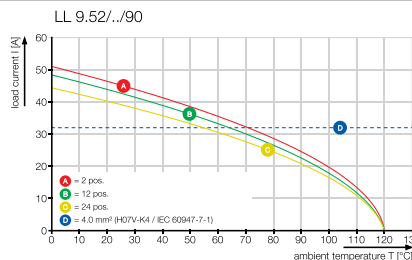

LL 9.52, multi level

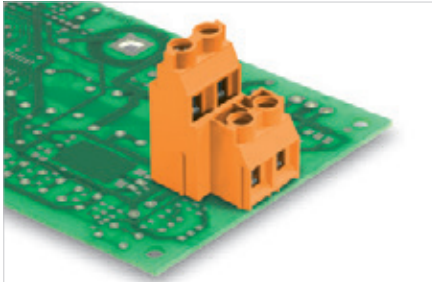

Double-level PCB terminal with our proven clamping-yoke screw connection in 9.52 mm pitch, suitable for wire cross-sections up to 6 mm².

- Increased derating reserves because WEMID insulating material is used.
- Wire outlet direction of 90°.
- Block construction can be aligned together for higher pole counts.

Technical data

In compliance with IEC 60664-1 / IEC 61984

Clamping range, max.	mm ²	0.18...6
Solid core H05(07) V-U	mm²	0.18...6
Stranded H07 V-R		
Flexible H05(07) V-K	mm ²	0.22...4
Flexible with ferrule	mm ²	0.5...2.5
Ferrule with plastic collar	mm ²	0.5...2.5
Stripping length	mm	7
Screwdriver blade	mm	0.8 x 4.0
According to norm		DIN 5264
Tightening torque range	Nm	0.5...0.6
Rated current, max.	A	32 32
At ambient temperature	20°C	40°C
For conductor cross-section	mm ²	4
Overvoltage category		III III II
Pollution severity		3 2 2
Rated voltage	V	690 690 1000
Rated impulse voltage	kV	6 6 6
UL / CUL (Use Group)	B C D	B C D
Rated voltage	V	300 300
Rated current	A	30 30
AWG conductor	AWG	26-10
CSA (Use Group)	B C D	B C D
Rated voltage	V	300 300
Rated current	A	30 30
AWG conductor	AWG	26-10
General data		
Type of insulation material		Wemid (PA)
UL 94 flammability rating		V-0
Contact base material		Copper alloy
Material of contact surface		tinned
Pin dimensions = d	mm	0.5 x 1.0
Solder eyelet Ø = D	mm	1.3
Solder eyelet Ø tolerance	mm	+ 0,1

Product data

IEC: 1000 V / 32 A / 0.18 - 6 mm²
UL: 300 V / 30 A / AWG 26 - 10

For additional articles and information, refer to catalog.weidmueller.com

Note:

- Rated current related to rated cross-section & min. No. of poles.
- Wire end ferrule without plastic collar to DIN 46228/1
- Wire end ferrule with plastic collar to DIN 46228/4
- P on drawing = pitch
- Rated data refer only to the component itself. Clearance and creepage distances to other components are to be designed in accordance with the relevant application standards.

LL2N 9.52/./90



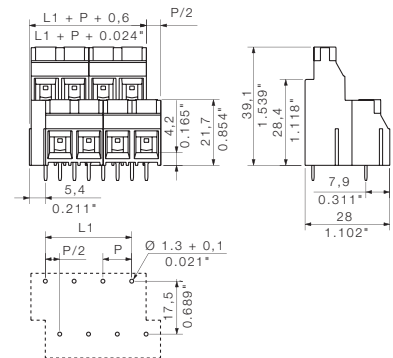

Dimensioned drawing



Accessories

Note: Refer to the Accessories chapter for additional accessories.

Screwdriver		Order No.
	SDIS 0.8X4.0X100	9008400000
	SDS 0.8X4.0X100	9008340000
Crosshead screwdriver		
	SDK PZ1	9008530000

Ordering data

Solder pin length		5 mm		
Colour		Orange		
Pitch		9.52 mm		
Pol.	L1	(inch)	Qty.	Order No.
4	9.52	3.750	10	1926350000
8	28.56	11.250	10	1926360000
12	47.60	18.750	10	1926370000
16	66.64	26.250	5	1926380000
20	85.68	33.750	5	1926390000
24	104.72	41.250	5	1926400000

Representative deratings curve

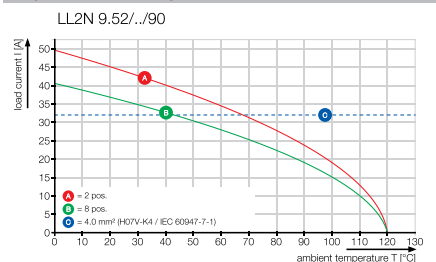

TOP 1.5GS/./-5.08

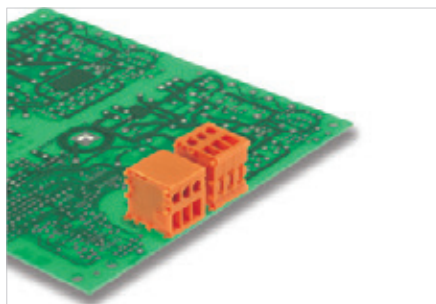

PCB terminal with TOP screw connection, in 5.08 mm pitch, for wire cross-sections up to 2.5 mm².

- Wire entry and screw connection in the same direction.
- In versions with 90° (horizontal) or 180° (vertical) angle to PCB.

Technical data

In compliance with IEC 60664-1 / IEC 61984			
Clamping range, max.	mm ²	0.13...2.5	
Solid core H05(07) V-U	mm ²	0.5...2.5	
Stranded H07 V-R			
Flexible H05(07) V-K	mm ²	0.5...2.5	
Flexible with ferrule	mm ²	0.5...2.5	
Ferrule with plastic collar	mm ²	0.5...2.5	
Stripping length	mm	10	
Screwdriver blade	mm	0.6 x 3.5	
According to norm		DIN 5264	
Tightening torque range	Nm	0.4...0.5	
Rated current, max.	A	24	21
At ambient temperature		20°C	40°C
For conductor cross-section	mm ²	2.5	
Overtolerance category		III	III II
Pollution severity		3	2 2
Rated voltage	V	250	320 630
Rated impulse voltage	kV	2.5	2.5 2.5
UL / CUL (Use Group)		B	C D
Rated voltage	V	300	300
Rated current	A	10	10
AWG conductor	AWG	26-14	
CSA (Use Group)		B	C D
Rated voltage	V	300	300
Rated current	A	10	10
AWG conductor	AWG	26-14	
General data			
Type of insulation material		PA	
UL 94 flammability rating		V-2	
Contact base material		CuZn	
Material of contact surface		tinned	
Pin dimensions = d	mm	0.8 x 1.0	
Solder eyelet Ø = D	mm	1.3	
Solder eyelet Ø tolerance	mm	+ 0,1	

Product data

IEC: 630 V / 24 A / 0.5 - 2.5 mm²
 UL: 300 V / 10 A / AWG 26 - 14

For additional articles and information, refer to catalog.weidmueller.com

Note:

- Additional colours on request
- Rated current related to rated cross-section & min. No. of poles.
- Wire end ferrule without plastic collar to DIN 46228/1
- Wire end ferrule with plastic collar to DIN 46228/4
- Crimp form A for wire end ferrules with PZ 6/5 crimping tool are recommended for the largest cable sizes.
- P on drawing = pitch
- Rated data refer only to the component itself. Clearance and creepage distances to other components are to be designed in accordance with the relevant application standards.

TOP 1.5GS/./-90-5.08



Dimensioned drawing

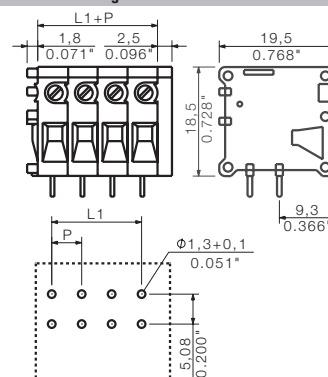

Ordering data

Solder pin length		3.5 mm		
Colour		Orange		
Pitch		5.08 mm		
Pol.	L1	(inch)	Qty.	Order No.
2	5.08	0.200	100	0641960000
3	10.16	0.400	100	0642060000
4	15.24	0.600	50	0642160000
5	20.32	0.800	50	1578820000
6	25.40	1.000	50	0593860000
7	30.48	1.200	50	0593960000
8	35.56	1.400	50	0594060000
9	40.64	1.600	50	0594160000
10	45.72	1.800	50	0642260000
11	50.80	2.000	50	0594260000
12	55.88	2.200	50	0594360000
13	60.96	2.400	50	0594460000
14	66.04	2.600	50	0594560000
15	71.12	2.800	50	0594660000
16	76.20	3.000	20	0642360000
17	81.28	3.200	20	0594760000
18	86.36	3.400	20	1707040000
19	91.44	3.600	10	0594960000
20	96.52	3.800	10	0595060000
21	101.60	4.000	10	0595160000
22	106.68	4.200	10	0595260000
23	111.76	4.400	10	0595360000
24	116.84	4.600	10	0595460000

Representative deratings curve

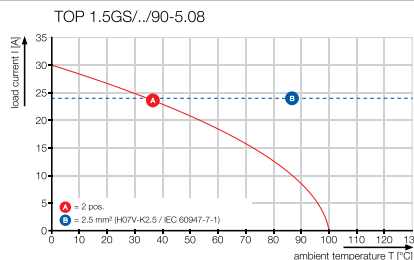

Accessories

Note: Refer to the Accessories chapter for additional accessories.

Mounting block		Order No.
	TOP1.5GS BB OR	1539860000
Screwdriver		
	SDIS 0.6X3.5X100	9008390000
	SDS 0.6X3.5X100	9008330000

TOP 1.5GS../180-5.08



Dimensioned drawing

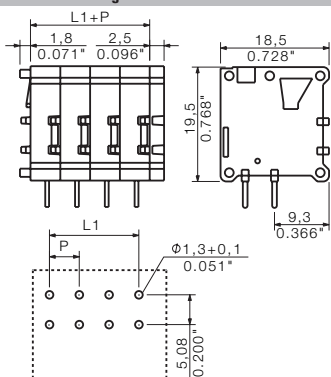

Ordering data

Solder pin length		4.5 mm		
Colour		Orange		
Pitch		5.08 mm		
Pol.	L1	(inch)	Qty.	Order No.
2	5.08	0.200	100	0569960000
3	10.16	0.400	100	0570160000
4	15.24	0.600	50	0570360000
5	20.32	0.800	50	0597360000
6	25.40	1.000	50	0597460000
7	30.48	1.200	50	1695700000
8	35.56	1.400	25	0597660000
9	40.64	1.600	20	1474660000
10	45.72	1.800	20	0570560000
11	50.80	2.000	20	1474760000
12	55.88	2.200	20	0597960000
13	60.96	2.400	20	1724740000
14	66.04	2.600	20	0598160000
15	71.12	2.800	20	1782490000
16	76.20	3.000	20	0570760000
17	81.28	3.200	20	0598360000
18	86.36	3.400	20	0598460000
19	91.44	3.600	20	0598560000
20	96.52	3.800	20	0598660000
21	101.60	4.000	10	0598760000
22	106.68	4.200	10	0598860000
23	111.76	4.400	10	0598960000
24	116.84	4.600	10	0599060000

Additional deratings curves

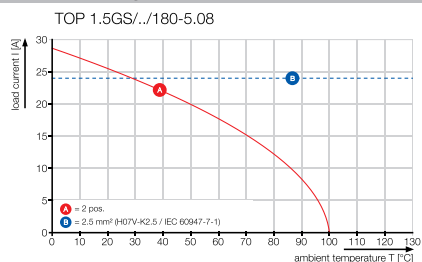

TOP 1.5GS/./-7.62

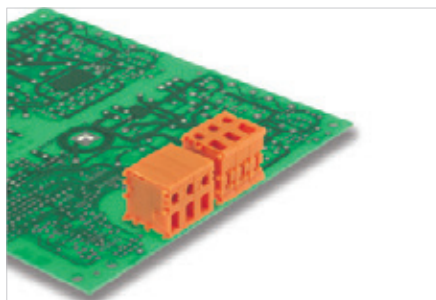

PCB terminal with TOP screw connection, in 7.62 mm pitch, for wire cross-sections up to 2.5 mm².

- Wire entry and screw connection in the same direction.
- In versions with 90° (horizontal) or 180° (vertical) angle to PCB.

Technical data

In compliance with IEC 60664-1 / IEC 61984		
Clamping range, max.	mm ²	0.13...2.5
Solid core H05(07) V-U	mm ²	0.5...2.5
Stranded H07 V-R		
Flexible H05(07) V-K	mm ²	0.5...2.5
Flexible with ferrule	mm ²	0.5...2.5
Ferrule with plastic collar	mm ²	0.5...2.5
Stripping length	mm	10
Screwdriver blade	mm	0.6 x 3.5
According to norm		DIN 5264
Tightening torque range	Nm	0.4...0.5
Rated current, max.	A	24 21
At ambient temperature		20°C 40°C
For conductor cross-section	mm ²	2.5
Overtolerance category		III III II
Pollution severity		3 2 2
Rated voltage	V	400 630 1000
Rated impulse voltage	kV	4 4 4
UL / CUL (Use Group)	B C D	B C D
Rated voltage	V	300 300
Rated current	A	10 10
AWG conductor	AWG	26-14
CSA (Use Group)	B C D	B C D
Rated voltage	V	300 300
Rated current	A	10 10
AWG conductor	AWG	26-14
General data		
Type of insulation material		PA
UL 94 flammability rating		V-2
Contact base material		CuZn
Material of contact surface		tinned
Pin dimensions = d	mm	0.8 x 1.0
Solder eyelet Ø = D	mm	1.3
Solder eyelet Ø tolerance	mm	+ 0,1

Product data

IEC: 1000 V / 24 A / 0.5 - 2.5 mm²
 UL: 300 V / 10 A / AWG 26 - 14



For additional articles and information, refer to catalog.weidmueller.com

Note:

- Additional colours on request
- Rated current related to rated cross-section & min. No. of poles.
- Wire end ferrule without plastic collar to DIN 46228/1
- Wire end ferrule with plastic collar to DIN 46228/4
- Crimp form A for wire end ferrules with PZ 6/5 crimping tool are recommended for the largest cable sizes.
- P on drawing = pitch
- Rated data refer only to the component itself. Clearance and creepage distances to other components are to be designed in accordance with the relevant application standards.

Accessories

Note: Refer to the Accessories chapter for additional accessories.

Mounting block		Order No.
	TOP1.5GS BB OR	1539860000
Screwdriver		
	SDIS 0.6X3.5X100	9008390000
	SDS 0.6X3.5X100	9008330000

TOP 1.5GS/./-90-7.62



Dimensioned drawing

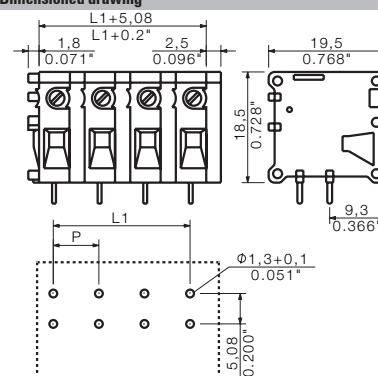

Ordering data

Solder pin length		3.5 mm		
Colour		Orange		
Pitch		7.62 mm		
Pol.	L1	(inch)	Qty.	Order No.
2	7.62	0.300	100	0393360000
3	15.24	0.600	100	0393460000
4	22.86	0.900	50	0393560000
5	30.48	1.200	25	0393660000
6	38.10	1.500	20	1683990000
7	45.72	1.800	20	1647310000
8	53.34	2.100	20	0642460000
9	60.96	2.400	20	0393960000
10	68.58	2.700	20	0642560000
11	76.20	3.000	20	0394060000
12	83.82	3.300	20	0394160000

Representative deratings curve

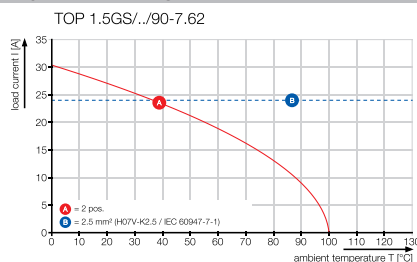

TOP 1.5GS/./180-7.62



Dimensioned drawing

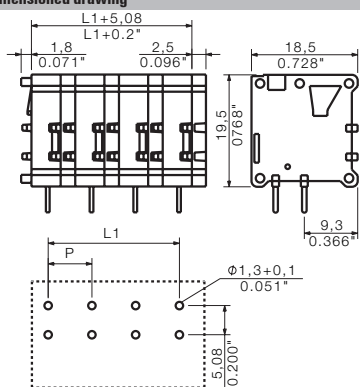

Ordering data

Solder pin length		4.5 mm	
Colour		Orange	
Pitch		7.62 mm	
Pol.	L1	(inch)	Qty. Order No.
2	7.62	0.300	100 0391360000
3	15.24	0.600	50 0391460000
4	22.86	0.900	50 0391560000
5	30.48	1.200	25 1490460000
6	38.10	1.500	25 1597060000
7	45.72	1.800	25 1597070000
8	53.34	2.100	20 0570960000
9	60.96	2.400	20 1597080000
10	68.58	2.700	20 0571160000
11	76.20	3.000	20 1597090000
12	83.82	3.300	20 0392160000

Additional deratings curves

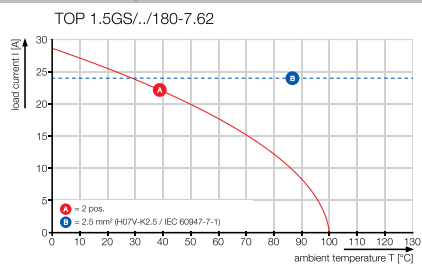

TOP 4GS../-6.35

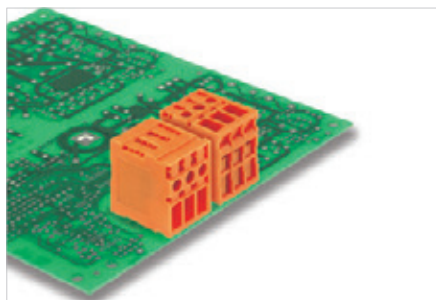

PCB terminal with TOP screw connection, in 6.35 mm pitch, for wire cross-sections up to 6.0 mm².

- Wire entry and screw connection in the same direction.
- In versions with 90° (horizontal) or 180° (vertical) angle to PCB.

Technical data

In compliance with IEC 60664-1 / IEC 61984			
Clamping range, max.	mm ²	0.13...6	
Solid core H05(07) V-U	mm ²	0.5...6	
Stranded H07 V-R			
Flexible H05(07) V-K	mm ²	0.5...4	
Flexible with ferrule	mm ²	0.5...4	
Ferrule with plastic collar	mm ²	0.5...4	
Stripping length	mm	13	
Screwdriver blade	mm	0.6 x 3.5	
According to norm		DIN 5264	
Tightening torque range	Nm	0.5...0.6	
Rated current, max.	A	32	32
At ambient temperature		20°C	40°C
For conductor cross-section	mm ²	4	
Overtoltage category		III	III II
Pollution severity		3	2 2
Rated voltage	V	320	320 320
Rated impulse voltage	kV	2.5	2.5 2.5
UL / CUL (Use Group)		B	C D
Rated voltage	V	300	300
Rated current	A	30	10
AWG conductor	AWG	26-10	
CSA (Use Group)		B	C D
Rated voltage	V	300	300
Rated current	A	30	10
AWG conductor	AWG	26-10	
General data			
Type of insulation material		PA	
UL 94 flammability rating		V-2	
Contact base material		E-Cu	
Material of contact surface		tinned	
Pin dimensions = d	mm	0.8 x 0.8	
Solder eyelet Ø = D	mm	1.3	
Solder eyelet Ø tolerance	mm	+ 0,1	

Product data

IEC: 320 V / 32 A / 0.5 - 6 mm²
 UL: 300 V / 30 A / AWG 26 - 10

For additional articles and information, refer to catalog.weidmueller.com

Note:

- Additional colours on request
- Rated current related to rated cross-section & min. No. of poles.
- Wire end ferrule without plastic collar to DIN 46228/1
- Wire end ferrule with plastic collar to DIN 46228/4
- Crimp form A for wire end ferrules with PZ 6/5 crimping tool are recommended for the largest cable sizes.
- P on drawing = pitch
- Rated data refer only to the component itself. Clearance and creepage distances to other components are to be designed in accordance with the relevant application standards.

TOP 4GS../-90-6.35



Dimensioned drawing

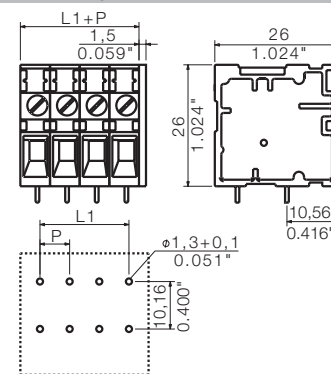

Ordering data

Solder pin length		3.5 mm		
Colour		Orange		
Pitch		6.35 mm		
Pol.	L1	(inch)	Qty.	Order No.
2	6.35	0.250	100	1401760000
3	12.70	0.500	100	1650300000
4	19.05	0.750	50	1786030000
5	25.40	1.000	50	1786040000
6	31.75	1.250	50	1786050000
7	38.10	1.500	50	1786060000
8	44.45	1.750	50	1667910000
9	50.80	2.000	50	1786070000
10	57.15	2.250	50	1786080000
11	63.50	2.500	50	1786090000
12	69.85	2.750	50	1786100000

Accessories

Note: Refer to the Accessories chapter for additional accessories.

Screwdriver	Order No.
SDIS 0.6X3.5X100	9008390000
SDS 0.6X3.5X100	9008330000

Representative deratings curve

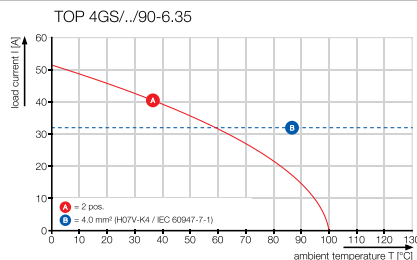

TOP 4GS../180-6.35



Dimensioned drawing

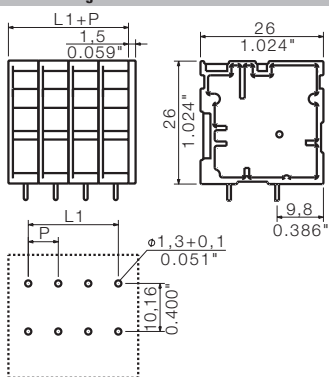

Ordering data

Solder pin length		3.5 mm		
Colour		Orange		
Pitch		6.35 mm		
Pol.	L1	(inch)	Qty.	Order No.
2	6.35	0.250	100	1786190000
3	12.70	0.500	100	1786200000
4	19.05	0.750	50	1786210000
5	25.40	1.000	50	1786220000
6	31.75	1.250	50	1786230000
7	38.10	1.500	50	1786240000
8	44.45	1.750	50	1786250000
9	50.80	2.000	50	1786260000
10	57.15	2.250	50	1786270000
11	63.50	2.500	50	1786280000
12	69.85	2.750	50	1786290000

Additional deratings curves

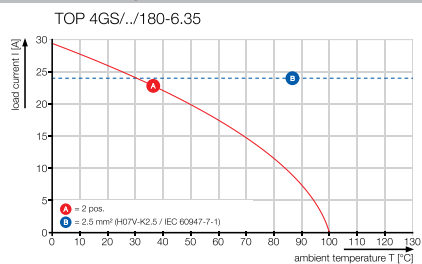

TOP 4GS../-7.62

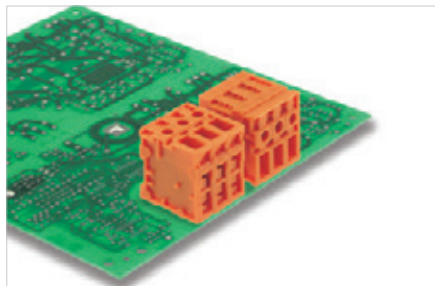

PCB terminal with TOP screw connection, in 7.62 mm pitch, for wire cross-sections up to 6.0 mm².

- Wire entry and screw connection in the same direction.
- In versions with 90° (horizontal) or 180° (vertical) angle to PCB.

Technical data

In compliance with IEC 60664-1 / IEC 61984		
Clamping range, max.	mm ²	0.13...6
Solid core H05(07) V-U	mm ²	0.5...6
Stranded H07 V-R		
Flexible H05(07) V-K	mm ²	0.5...4
Flexible with ferrule	mm ²	0.5...4
Ferrule with plastic collar	mm ²	0.5...4
Stripping length	mm	13
Screwdriver blade	mm	0.6 x 3.5
According to norm		DIN 5264
Tightening torque range	Nm	0.5...0.6
Rated current, max.	A	32 32
At ambient temperature		20°C 40°C
For conductor cross-section	mm ²	4
Overtolerance category		III III II
Pollution severity		3 2 2
Rated voltage	V	500 630 1000
Rated impulse voltage	kV	4 4 4
UL / CUL (Use Group)	B C D	B C D
Rated voltage	V	300 300
Rated current	A	30 10
AWG conductor	AWG	26-10
CSA (Use Group)	B C D	B C D
Rated voltage	V	300 300
Rated current	A	30 10
AWG conductor	AWG	26-10
General data		
Type of insulation material		PA
UL 94 flammability rating		V-2
Contact base material		E-Cu
Material of contact surface		tinned
Pin dimensions = d	mm	0.8 x 0.8
Solder eyelet Ø = D	mm	1.3
Solder eyelet Ø tolerance	mm	+ 0,1

Product data

IEC: 1000 V / 32 A / 0.5 - 6 mm²
 UL: 300 V / 30 A / AWG 26 - 10

For additional articles and information, refer to catalog.weidmueller.com

Note:

- Additional colours on request
- Rated current related to rated cross-section & min. No. of poles.
- Wire end ferrule without plastic collar to DIN 46228/1
- Wire end ferrule with plastic collar to DIN 46228/4
- Crimp form A for wire end ferrules with PZ 6/5 crimping tool are recommended for the largest cable sizes.
- P on drawing = pitch
- Rated data refer only to the component itself. Clearance and creepage distances to other components are to be designed in accordance with the relevant application standards.

TOP 4GS../90-7.62



Dimensioned drawing

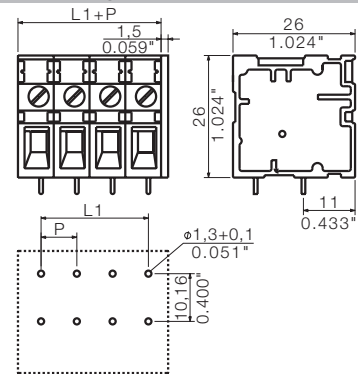

Ordering data

Solder pin length		3.5 mm		
Colour		Orange		
Pitch		7.62 mm		
Pol.	L1	(inch)	Qty.	Order No.
2	7.62	0.300	50	0289660000
3	15.24	0.600	50	0289760000
4	22.86	0.900	50	0290160000
5	30.48	1.200	50	1698740000
6	38.10	1.500	50	1786410000
7	45.72	1.800	50	1647300000
8	53.34	2.100	50	1786420000
9	60.96	2.400	50	1786430000
10	68.58	2.700	50	1786440000
11	76.20	3.000	50	1759860000
12	83.82	3.300	50	1786450000

Accessories

Note: Refer to the Accessories chapter for additional accessories.

Screwdriver	Order No.
SDIS 0.6X3.5X100	9008390000
SDS 0.6X3.5X100	9008330000

Representative deratings curve

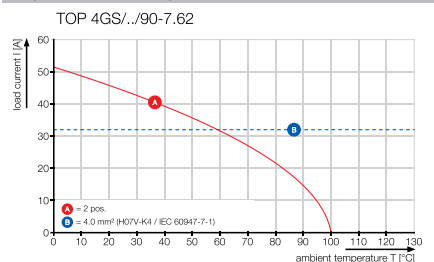

TOP 4GS../180-7.62



Dimensioned drawing

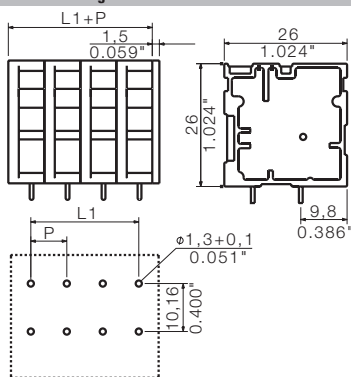

Ordering data

Solder pin length		3.5 mm	
Colour		Orange	
Pitch		7.62 mm	
Pol.	L1	(inch)	Qty. Order No.
2	7.62	0.300	50 0298360000
3	15.24	0.600	50 0298460000
4	22.86	0.900	50 0298560000
5	30.48	1.200	50 1786540000
6	38.10	1.500	50 1494560000
7	45.72	1.800	50 1786550000
8	53.34	2.100	50 1786560000
9	60.96	2.400	50 1571700000
10	68.58	2.700	50 1786570000
11	76.20	3.000	50 1786580000
12	83.82	3.300	50 1749170000

Additional deratings curves

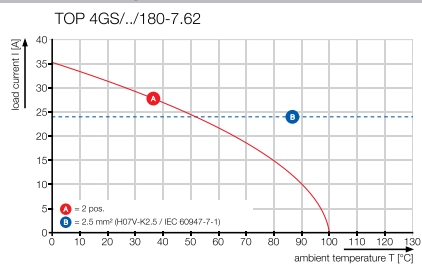

PS 3.5/..90

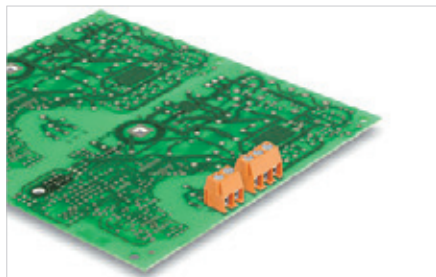

Very compact PCB terminal with pressure-clamp screw connection, in 3.5 mm pitch for wire cross-sections up to 1.5 mm².

- Increased derating reserves because WEMID insulating material is used.
- Wire outlet direction of 90°.
- 2- and 3-pole block construction can be aligned together for higher pole counts.

Technical data

In compliance with IEC 60664-1 / IEC 61984		
Clamping range, max.	mm ²	0.08...1.5
Solid core H05(07) V-U	mm ²	0.2...1.5
Stranded H07 V-R		
Flexible H05(07) V-K	mm ²	0.2...1.5
Flexible with ferrule	mm ²	0.25...0.75
Ferrule with plastic collar	mm ²	0.25...0.75
Stripping length	mm	4
Screwdriver blade	mm	0.4 x 2.5
According to norm		DIN 5264
Tightening torque range	Nm	0.2...0.25
Rated current, max.	A	17.5 17.5
At ambient temperature	20°C	40°C
For conductor cross-section	mm ²	0.75
Overtoltage category		III III II
Pollution severity		3 2 2
Rated voltage	V	160 160 320
Rated impulse voltage	kV	2.5 2.5 2.5
UL / CUL (Use Group)	B C D	
Rated voltage	V	300 300
Rated current	A	10 10
AWG conductor	AWG	28-16
CSA (Use Group)	B C D	
Rated voltage	V	300
Rated current	A	10
AWG conductor	AWG	28-16
General data		
Type of insulation material		Wemid (PA)
UL 94 flammability rating		V-0
Contact base material		Copper alloy
Material of contact surface		tinned
Pin dimensions = d	mm	0.8
Solder eyelet Ø = D	mm	1.3
Solder eyelet Ø tolerance	mm	+ 0,1

Product data

IEC: 320 V / 17.5 A / 0.2 - 1.5 mm²
 UL: 300 V / 10 A / AWG 28 - 16

For additional articles and information, refer to catalog.weidmueller.com

Note:

- Rated current related to rated cross-section & min. No. of poles.
- Wire end ferrule without plastic collar to DIN 46228/1
- Wire end ferrule with plastic collar to DIN 46228/4
- The data given under CSA relates to a cUL approval - E60693
- P on drawing = pitch
- Rated data refer only to the component itself. Clearance and creepage distances to other components are to be designed in accordance with the relevant application standards.

Accessories

Note: Refer to the Accessories chapter for additional accessories.

Screwdriver	Order No.
SDIS 0.6X3.5X100	9008390000

PS 3.5/..90



Dimensioned drawing

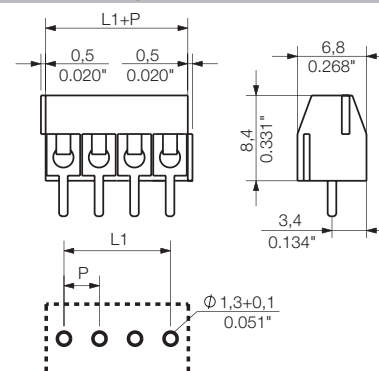

Ordering data

Solder pin length		3.5 mm		
Colour		Orange		
Pitch		3.50 mm		
Pol.	L1	(inch)	Qty.	Order No.
2	3.50	0.138	100	1912320000
3	7.00	0.276	100	1912330000
4	10.50	0.413	100	1912340000
5	14.00	0.551	100	1912350000
6	17.50	0.689	100	1912360000
7	21.00	0.827	100	1912370000
8	24.50	0.965	100	1912380000
9	28.00	1.102	100	1912390000
10	31.50	1.240	100	1912400000
11	35.00	1.378	100	1912410000
12	38.50	1.516	100	1912420000

Representative deratings curve

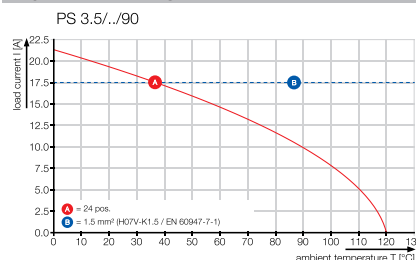

PM 5.00/./90

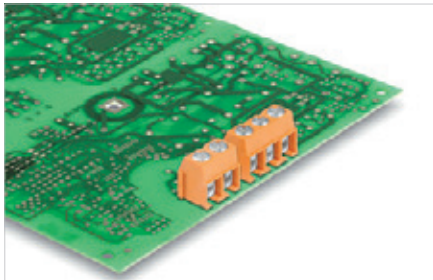

PCB terminal with pressure-clamp screw connection in 5.00 and 5.08 mm pitches for wire cross-sections up to 2.5 mm².

- Increased derating reserves because WEMID insulating material is used.
- Wire outlet direction of 90°.
- 2- and 3-pole block construction can be aligned together for higher pole counts.

Technical data

In compliance with IEC 60664-1 / IEC 61984

Clamping range, max.	mm ²	0.13...2.5
Solid core H05(07) V-U	mm²	0.13...2.5
Stranded H07 V-R		
Flexible H05(07) V-K	mm ²	0.13...2.5
Flexible with ferrule	mm ²	0.25...1.5
Ferrule with plastic collar	mm ²	0.25...1.5
Stripping length	mm	6
Screwdriver blade	mm	0.6 x 3.5
According to norm		DIN 5264
Tightening torque range	Nm	0.4...0.5
Rated current, max.	A	24 24
At ambient temperature		20°C 40°C
For conductor cross-section	mm ²	1.5
Overtoltage category		III III II
Pollution severity		3 2 2
Rated voltage	V	250 250 600
Rated impulse voltage	kV	4 4 4
UL / CUL (Use Group)	B C D	B C D
Rated voltage	V	300 300
Rated current	A	15 10
AWG conductor	AWG	26-14
CSA (Use Group)	B C D	B C D
Rated voltage	V	300 300
Rated current	A	15 10
AWG conductor	AWG	26-14
General data		
Type of insulation material		Wemid (PA)
UL 94 flammability rating		V-0
Contact base material		Copper alloy
Material of contact surface		tinned
Pin dimensions = d	mm	1.0
Solder eyelet Ø = D	mm	1.3
Solder eyelet Ø tolerance	mm	+ 0,1

Product data

IEC: 600 V / 24 A / 0.13 - 2.5 mm²
 UL: 300 V / 15 A / AWG 26 - 14

For additional articles and information, refer to catalog.weidmueller.com

Note:

- Rated current related to rated cross-section & min. No. of poles.
- Wire end ferrule without plastic collar to DIN 46228/1
- Wire end ferrule with plastic collar to DIN 46228/4
- The data given under CSA relates to a cUL approval - E60693
- P on drawing = pitch
- Rated data refer only to the component itself. Clearance and creepage distances to other components are to be designed in accordance with the relevant application standards.

PM 5.00/./90



Dimensioned drawing

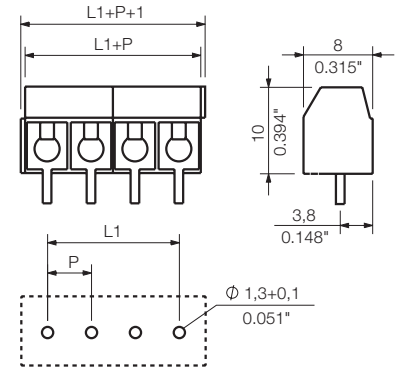

Ordering data

Solder pin length		3.5 mm		
Colour		Orange		
Pitch		5.00 mm		
Pol.	L1	(inch)	Qty.	Order No.
2	5.00	0.197	500	1791610000
3	10.00	0.394	500	1791620000
4	15.00	0.591	100	1234650000
5	20.00	0.787	100	1234670000
6	10.00	0.394	100	1234680000
7	30.00	1.181	100	1234690000
8	35.00	1.378	100	1234700000
9	40.00	1.575	100	1234710000
10	45.00	1.772	100	1234720000
11	50.00	1.969	100	1234730000
12	55.00	2.165	100	1234740000

Accessories

Note: Refer to the Accessories chapter for additional accessories.

Screwdriver	Order No.
SDIS 0.6X3.5X100	9008390000

Representative deratings curve

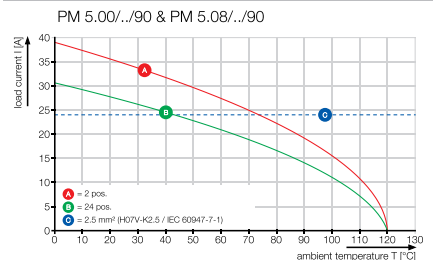

PM 5.08/./90

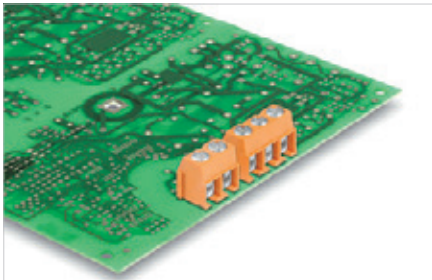

PCB terminal with pressure-clamp screw connection in 5.00 and 5.08 mm pitches for wire cross-sections up to 2.5 mm².

- Increased derating reserves because WEMID insulating material is used.
- Wire outlet direction of 90°.
- 2- and 3-pole block construction can be aligned together for higher pole counts.

Technical data

In compliance with IEC 60664-1 / IEC 61984		
Clamping range, max.	mm ²	0.13...2.5
Solid core H05(07) V-U	mm ²	0.13...2.5
Stranded H07 V-R		
Flexible H05(07) V-K	mm ²	0.13...2.5
Flexible with ferrule	mm ²	0.25...1.5
Ferrule with plastic collar	mm ²	0.25...1.5
Stripping length	mm	6
Screwdriver blade	mm	0.6 x 3.5
According to norm		DIN 5264
Tightening torque range	Nm	0.4...0.5
Rated current, max.	A	24 24
At ambient temperature		20°C 40°C
For conductor cross-section	mm ²	1.5
Overtoltage category		III III II
Pollution severity		3 2 2
Rated voltage	V	250 250 600
Rated impulse voltage	kV	4 4 4
UL / CUL (Use Group)	B C D	
Rated voltage	V	300 300
Rated current	A	15 10
AWG conductor	AWG	26-14
CSA (Use Group)	B C D	
Rated voltage	V	300 300
Rated current	A	15 10
AWG conductor	AWG	26-14
General data		
Type of insulation material		Wemid (PA)
UL 94 flammability rating		V-0
Contact base material		Copper alloy
Material of contact surface		tinned
Pin dimensions = d	mm	1.0
Solder eyelet Ø = D	mm	1.3
Solder eyelet Ø tolerance	mm	+ 0,1

Product data

IEC: 600 V / 24 A / 0.13 - 2.5 mm²
 UL: 300 V / 15 A / AWG 26 - 14

For additional articles and information, refer to catalog.weidmueller.com

Note:

- Rated current related to rated cross-section & min. No. of poles.
- Wire end ferrule without plastic collar to DIN 46228/1
- Wire end ferrule with plastic collar to DIN 46228/4
- The data given under CSA relates to a cUL approval - E60693
- P on drawing = pitch
- Rated data refer only to the component itself. Clearance and creepage distances to other components are to be designed in accordance with the relevant application standards.

Accessories

Note: Refer to the Accessories chapter for additional accessories.

PM 5.08/./90



Dimensioned drawing

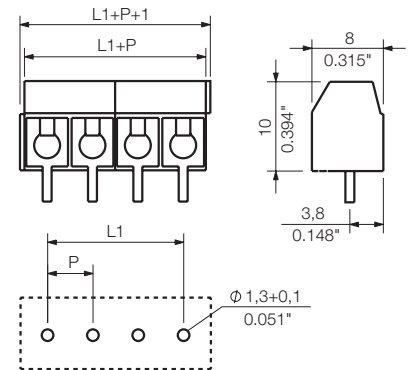

Ordering data

Solder pin length		3.5 mm		
Colour		Orange		
Pitch		5.08 mm		
Pol.	L1	(inch)	Qty.	Order No.
2	5.08	0.200	500	1760490000
3	10.16	0.400	500	1760500000
4	15.24	0.600	100	1234550000
5	20.32	0.800	100	1234570000
6	25.40	1.000	100	1234580000
7	30.48	1.200	100	1234590000
8	35.56	1.400	100	1234600000
9	40.64	1.600	100	1234610000
10	45.72	1.800	100	1234620000
11	50.80	2.000	100	1234630000
12	55.88	2.200	100	1234640000

Representative deratings curve

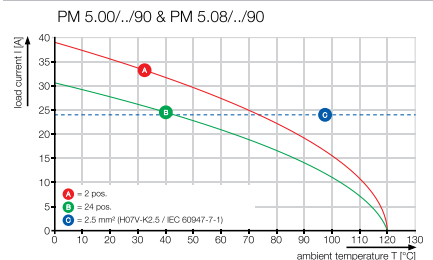

LSF-SMD 3.50/180

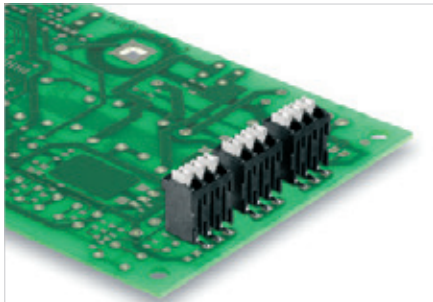

PCB terminal for fully automatic assembly using reflow soldering (SMD), with PUSH IN wire connections. Conductor inserted and slider operated in same direction (TOP).

- Solid wires & stranded wires with wire-end ferrules need only to be inserted and they are ready.
- When connecting stranded wires without wire-end ferrules the handling area is used to open the terminal point
- Intuitive handling - since the wire-entry area and handling area are clearly separated.
- Packaged in tape-on-reel
- Conductor outlet direction 180°

Technical data

In compliance with IEC 60664-1 / IEC 61984			
Clamping range, max.	mm ²	0.13...1.5	
Solid core H05(07) V-U	mm ²	0.2...1.5	
Stranded H07 V-R			
Flexible H05(07) V-K	mm ²	0.2...1.5	
Flexible with ferrule	mm ²	0.25...1.5	
Ferrule with plastic collar	mm ²	0.25...0.75	
Stripping length	mm		
Screwdriver blade	mm		
According to norm			
Tightening torque range	Nm		
Rated current, max.	A	17.5	17.5
At ambient temperature		20°C	40°C
For conductor cross-section	mm ²	1.5	
Overtoltage category		III	III II
Pollution severity		3	2 2
Rated voltage	V	160	160 320
Rated impulse voltage	kV	2.5	2.5 2.5
UL / CUL (Use Group)		B	C D
Rated voltage	V	300	300
Rated current	A	12	10
AWG conductor	AWG	24-16	
CSA (Use Group)		B	C D
Rated voltage	V	300	300
Rated current	A	10	10
AWG conductor	AWG	24-16	
General data			
Type of insulation material		LCP GF	
UL 94 flammability rating		V-0	
Contact base material		Copper alloy	
Material of contact surface		tinned	
Pin dimensions = d	mm	0.35 x 0.8	
Solder eyelet Ø = D	mm		
Solder eyelet Ø tolerance	mm		

Product data

IEC: 320 V / 17.5 A / 0.2 - 1.5 mm²
 UL: 300 V / 12 A / AWG 24 - 16

For additional articles and information, refer to catalog.weidmuller.com

Note:

- Additional push button colours on request
- Rated current related to rated cross-section & min. No. of poles.
- Wire end ferrule without plastic collar to DIN 46228/1
- P on drawing = pitch
- Operating force of slider max. 40 N
- Rated data refer only to the component itself. Clearance and creepage distances to other components are to be designed in accordance with the relevant application standards.
- Crimping shape „A“ for wire end ferrules with PZ 6/5 crimping tool are recommended for the largest cable sizes.

LSF-SMD 3.50/180

Reflow-compatible PCB terminal



Dimensioned drawing

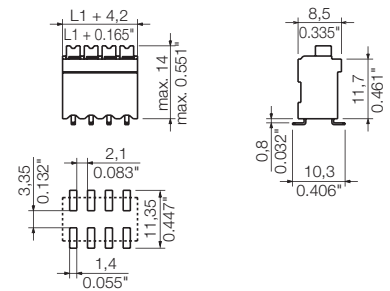

Accessories

Note: Refer to the Accessories chapter for additional accessories.

Screwdriver		Order No.
	SDIS 0.4X2.5X75	9008370000
	SDS 0.4X2.5X75	9009030000

Ordering data

Solder pin length					
Colour					Black
Pitch 3.50 mm					
Pol.	L1	(inch)	Qty.	Order No.	
2	3.50	0.138	180	1250360000	
3	7.00	0.276	180	1250370000	
4	10.50	0.414	180	1250380000	
5	14.00	0.552	180	1250390000	
6	17.50	0.690	180	1250410000	
7	21.00	0.828	180	1250420000	
8	24.50	0.966	180	1250430000	
9	28.00	1.104	180	1250440000	
10	31.50	1.242	180	1250450000	
11	35.00	1.380	180	1250460000	
12	38.50	1.518	180	1250470000	

Representative deratings curve

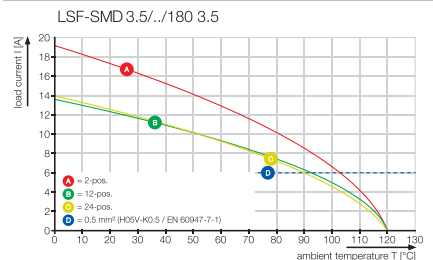

LSF-SMT 3.5/.. /90

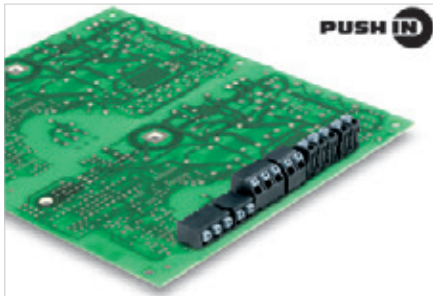

PUSH IN

PCB terminal for fully automatic assembly, in 3.5 mm pitch, for THR reflow soldering (SMT) and wave soldering.

- PUSH IN wire connection, for wire cross-sections up to 1.5 mm².
- Form and dimensional stability provided by the LCP insulating material.
- Conductor inserted and slider operated in same direction (TOP).
- Packaged in tube or tape-on-reel.
- Pin lengths optimised to 1.5 mm or 3.5 mm.
- Wire outlet direction of 90°.

Technical data

In compliance with IEC 60664-1 / IEC 61984			
Clamping range, max.	mm ²	0.13...1.5	
Solid core H05(07) V-U	mm ²	0.2...1.5	
Stranded H07 V-R			
Flexible H05(07) V-K	mm ²	0.2...1.5	
Flexible with ferrule	mm ²	0.25...1.5	
Ferrule with plastic collar	mm ²	0.25...0.75	
Stripping length	mm	8	
Screwdriver blade	mm		
According to norm			
Tightening torque range	Nm		
Rated current, max.	A	17.5	17.5
At ambient temperature		20°C	40°C
For conductor cross-section	mm ²	1.5	
Overtoltage category		III	III II
Pollution severity		3	2 2
Rated voltage	V	160	160 320
Rated impulse voltage	kV	2.5	2.5 2.5
UL / CUL (Use Group)		B	C D
Rated voltage	V	300	300
Rated current	A	12	10
AWG conductor	AWG	24-16	
CSA (Use Group)		B	C D
Rated voltage	V	300	300
Rated current	A	10	10
AWG conductor	AWG	24-16	
General data			
Type of insulation material		LCP GF	
UL 94 flammability rating		V-0	
Contact base material		Copper alloy	
Material of contact surface		tinned	
Pin dimensions = d	mm	0.35 x 0.8	
Solder eyelet Ø = D	mm	1.1	
Solder eyelet Ø tolerance	mm	+ 0,1	

Product data

IEC: 320 V / 17.5 A / 0.2 - 1.5 mm²
 UL: 300 V / 12 A / AWG 24 - 16

For additional articles and information, refer to catalog.weidmueller.com

Note:

- Additional push button colours on request
- Rated current related to rated cross-section & min. No. of poles.
- Wire end ferrule without plastic collar to DIN 46228/1
- P on drawing = pitch
- Operating force of slider max. 40 N
- Rated data refer only to the component itself. Clearance and creepage distances to other components are to be designed in accordance with the relevant application standards.
- Crimping shape „A“ for wire end ferrules with PZ 6/5 crimping tool are recommended for the largest cable sizes.

LSF-SMT 3.5/.. /90

Reflow-compatible PCB Terminal



Dimensioned drawing

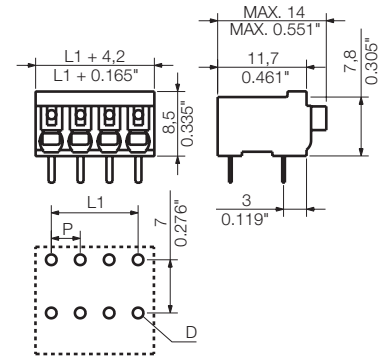

Accessories

Note: Refer to the Accessories chapter for additional accessories.

Screwdriver		Order No.
	SDIS 0.4X2.5X75	9008370000
	SDS 0.4X2.5X75	9009030000

Ordering data

Solder pin length		1.5 mm	3.5 mm		
Colour		Black	Black		
Pitch 3.50 mm					
Pol.	L1 (inch)	Qty.	Order No.	Order No.	
2	3.50	0.138	71	1870500000	1824420000
3	7.00	0.276	49	1870530000	1824430000
4	10.50	0.413	37	1870550000	1824440000
5	14.00	0.551	30	1870580000	1824450000
6	17.50	0.689	25	1870590000	1824460000
7	21.00	0.827	21	1871020000	1824470000
8	24.50	0.965	19	1871030000	1824480000
9	28.00	1.102	17	1871040000	1824490000
10	31.50	1.240	15	1871050000	1824500000
11	35.00	1.378	14	1871060000	1824510000
12	38.50	1.516	12	1871070000	1824520000
13	42.00	1.654	11	1871080000	1870380000
14	45.50	1.791	11	1871090000	1870390000
15	49.00	1.929	10	1871100000	1870400000
16	52.50	2.067	9	1871110000	1870410000
17	56.00	2.205	9	1871120000	1870420000
18	59.50	2.343	8	1871130000	1870430000
19	63.00	2.480	8	1871140000	1870440000
20	66.50	2.618	7	1871150000	1870450000
21	70.00	2.756	7	1871160000	1870460000
22	73.50	2.894	7	1871170000	1870470000
23	77.00	3.031	6	1871180000	1870480000
24	80.50	3.169	6	1871190000	1870490000

Representative deratings curve

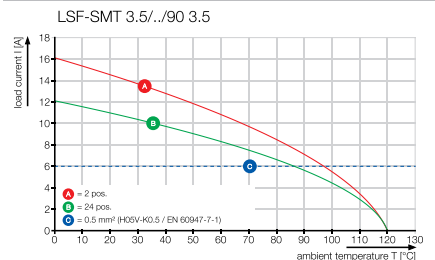

LSF-SMT 3.5/./90 Tape

Reflow-compatible PCB Terminal



Dimensioned drawing

Ordering data

Solder pin length		1.5 mm	3.5 mm
Colour		Black	Black
Pitch		3.50 mm	
Pol.	L1 (inch)	Qty.	Order No.
2	3.50	0.138	265 1874690000 1874990000
3	7.00	0.276	265 1874710000 1875030000
4	10.50	0.413	265 1874730000 1875050000
5	14.00	0.551	265 1874740000 1875070000
6	17.50	0.689	265 1874810000 1875080000
7	21.00	0.827	265 1874840000 1875100000
8	24.50	0.965	265 1874890000 1875110000
9	28.00	1.102	265 1874900000 1875120000
10	31.50	1.240	265 1874930000 1875130000
11	35.00	1.378	265 1874940000 1875140000
12	38.50	1.516	265 1874970000 1875160000

Tape widths: 32, 44, 56, 72, 88

Additional deratings curves

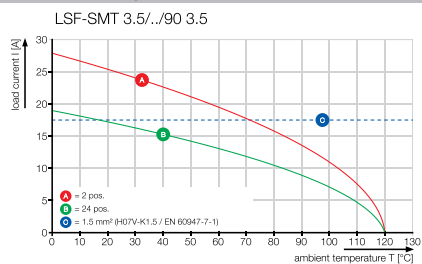

LSF-SMT 3.5/./135

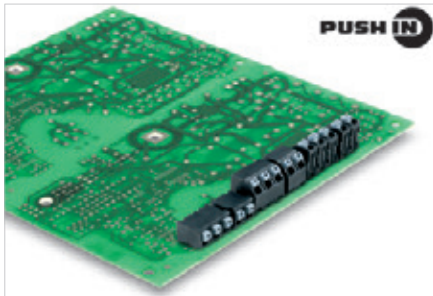

PCB terminal for fully automatic assembly, in 3.5 mm pitch, for THR reflow soldering (SMT) and wave soldering.

- PUSH IN wire connection, for wire cross-sections up to 1.5 mm².
- Form and dimensional stability provided by the LCP insulating material.
- Conductor inserted and slider operated in same direction (TOP).
- Packaged in tube or tape-on-reel.
- Pin lengths optimised to 1.5 mm or 3.5 mm.
- Wire outlet direction of 135°.

Technical data

In compliance with IEC 60664-1 / IEC 61984			
Clamping range, max.	mm ²	0.13...1.5	
Solid core H05(07) V-U	mm ²	0.2...1.5	
Stranded H07 V-R			
Flexible H05(07) V-K	mm ²	0.2...1.5	
Flexible with ferrule	mm ²	0.25...1.5	
Ferrule with plastic collar	mm ²	0.25...0.75	
Stripping length	mm	8	
Screwdriver blade	mm		
According to norm			
Tightening torque range	Nm		
Rated current, max.	A	17.5	17.5
At ambient temperature		20°C	40°C
For conductor cross-section	mm ²	1.5	
Overtoltage category		III	III II
Pollution severity		3	2 2
Rated voltage	V	160	160 320
Rated impulse voltage	kV	2.5	2.5 2.5
UL / CUL (Use Group)		B	C D
Rated voltage	V	300	300
Rated current	A	12	10
AWG conductor	AWG	24-16	
CSA (Use Group)		B	C D
Rated voltage	V	300	300
Rated current	A	10	10
AWG conductor	AWG	24-16	
General data			
Type of insulation material		LCP GF	
UL 94 flammability rating		V-0	
Contact base material		Copper alloy	
Material of contact surface		tinned	
Pin dimensions = d	mm	0.35 x 0.8	
Solder eyelet Ø = D	mm	1.1	
Solder eyelet Ø tolerance	mm	+ 0,1	

Product data

IEC: 320 V / 17.5 A / 0.2 - 1.5 mm²
 UL: 300 V / 12 A / AWG 24 - 16

For additional articles and information, refer to catalog.weidmuller.com

Note:

- Additional push button colours on request
- Rated current related to rated cross-section & min. No. of poles.
- Wire end ferrule without plastic collar to DIN 46228/1
- P on drawing = pitch
- Operating force of slider max. 40 N
- Rated data refer only to the component itself. Clearance and creepage distances to other components are to be designed in accordance with the relevant application standards.
- Crimping shape „A“ for wire end ferrules with PZ 6/5 crimping tool are recommended for the largest cable sizes.

Accessories

Note: Refer to the Accessories chapter for additional accessories.

Screwdriver		Order No.
	SDIS 0.4X2.5X75	9008370000
	SDS 0.4X2.5X75	9009030000

LSF-SMT 3.5/./135

Reflow-compatible PCB Terminal



Dimensioned drawing

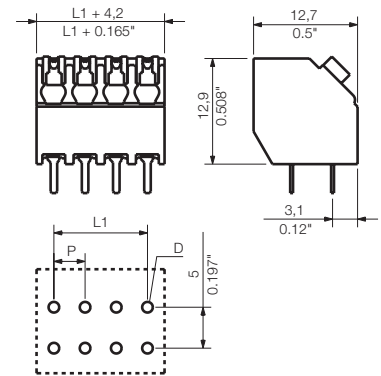

Ordering data

Solder pin length		1.5 mm	3.5 mm		
Colour		Black	Black		
Pitch 3.50 mm					
Pol.	L1 (inch)	Qty.	Order No.	Order No.	
2	3.50	0.138	71	1885180000	1885650000
3	7.00	0.276	49	1885190000	1885660000
4	10.50	0.413	37	1885200000	1885670000
5	14.00	0.551	30	1885210000	1885680000
6	17.50	0.689	25	1885220000	1885690000
7	21.00	0.827	21	1885230000	1885700000
8	24.50	0.965	19	1885240000	1885710000
9	28.00	1.102	17	1885250000	1885720000
10	31.50	1.240	15	1885260000	1885730000
11	35.00	1.378	14	1885270000	1885740000
12	38.50	1.516	12	1885280000	1885750000
13	42.00	1.654	11	1885290000	1885760000
14	45.50	1.791	11	1885300000	1885770000
15	49.00	1.929	10	1885310000	1885780000
16	52.50	2.067	9	1885320000	1885790000
17	56.00	2.205	9	1885330000	1885800000
18	59.50	2.343	8	1885340000	1885810000
19	63.00	2.480	8	1885350000	1885820000
20	66.50	2.618	7	1885360000	1885830000
21	70.00	2.756	7	1885370000	1885840000
22	73.50	2.894	7	1885380000	1885850000
23	77.00	3.031	6	1885390000	1885860000
24	80.50	3.169	6	1885400000	1885870000

Representative deratings curve

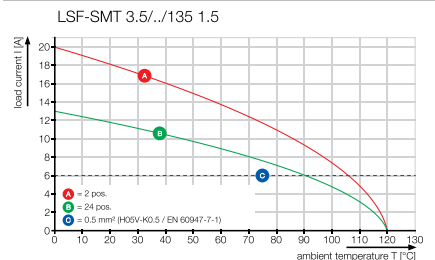

LSF-SMT 3.5/./135 Tape

Reflow-compatible PCB Terminal



Dimensioned drawing

Ordering data

Solder pin length		1.5 mm	3.5 mm
Colour		Black	Black
Pitch		3.50 mm	
Pol.	L1 (inch)	Qty.	Order No.
2	3.50	190	1887550000 1887340000
3	7.00	190	1887560000 1887350000
4	10.50	190	1887580000 1887360000
5	14.00	190	1887630000 1887460000
6	17.50	190	1887640000 1887470000
7	21.00	190	1887650000 1887480000
8	24.50	190	1887660000 1887490000
9	28.00	190	1887670000 1887500000
10	31.50	190	1887680000 1887510000
11	35.00	190	1887690000 1887520000
12	38.50	190	1887700000 1887530000

Tape widths: 32, 44, 56, 72, 88

Additional deratings curves

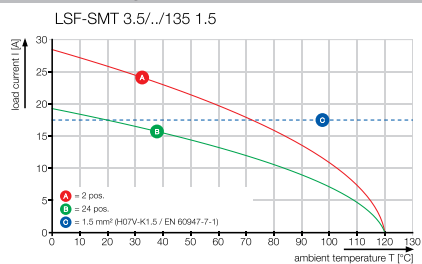

LSF-SMT 3.5/./180

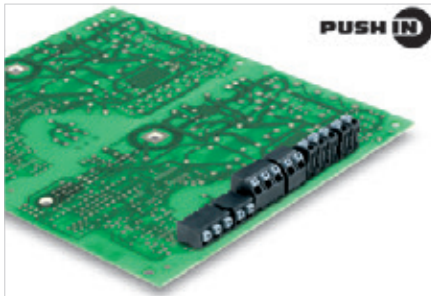

PCB terminal for fully automatic assembly, in 3.5 mm pitch, for THR reflow soldering (SMT) and wave soldering.

- PUSH IN wire connection, for wire cross-sections up to 1.5 mm².
- Form and dimensional stability provided by the LCP insulating material.
- Conductor inserted and slider operated in same direction (TOP).
- Packaged in tube or tape-on-reel.
- Pin lengths optimised to 1.5 mm or 3.5 mm.
- Wire outlet direction of 180°.

Product data

IEC: 320 V / 17.5 A / 0.2 - 1.5 mm²
UL: 300 V / 12 A / AWG 24 - 16

For additional articles and information, refer to catalog.weidmuller.com

Note:

- Additional push button colours on request
- Rated current related to rated cross-section & min. No. of poles.
- Wire end ferrule without plastic collar to DIN 46228/1
- P on drawing = pitch
- Operating force of slider max. 40 N
- Rated data refer only to the component itself. Clearance and creepage distances to other components are to be designed in accordance with the relevant application standards.
- Crimping shape „A“ for wire end ferrules with PZ 6/5 crimping tool are recommended for the largest cable sizes.

LSF-SMT 3.5/./180

Reflow-compatible PCB Terminal

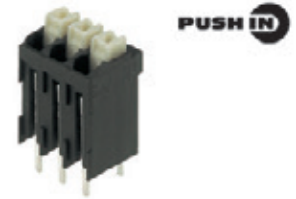

Dimensioned drawing

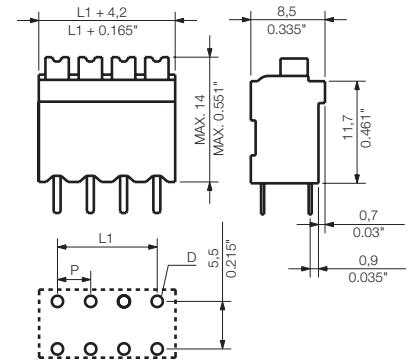

Technical data

In compliance with IEC 60664-1 / IEC 61984			
Clamping range, max.	mm ²	0.13...1.5	
Solid core H05(07) V-U	mm²	0.2...1.5	
Stranded H07 V-R			
Flexible H05(07) V-K	mm ²	0.2...1.5	
Flexible with ferrule	mm ²	0.25...1.5	
Ferrule with plastic collar	mm ²	0.25...0.75	
Stripping length	mm	8	
Screwdriver blade	mm		
According to norm			
Tightening torque range	Nm		
Rated current, max.	A	17.5	17.5
At ambient temperature		20°C	40°C
For conductor cross-section	mm ²	1.5	
Overtoltage category		III	III II
Pollution severity		3	2 2
Rated voltage	V	160	160 320
Rated impulse voltage	kV	2.5	2.5 2.5
UL / CUL (Use Group)		B	C D
Rated voltage	V	300	300
Rated current	A	12	10
AWG conductor	AWG	24-16	
CSA (Use Group)		B	C D
Rated voltage	V	300	300
Rated current	A	10	10
AWG conductor	AWG	24-16	
General data			
Type of insulation material		LCP GF	
UL 94 flammability rating		V-0	
Contact base material		Copper alloy	
Material of contact surface		tinned	
Pin dimensions = d	mm	0.35 x 0.8	
Solder eyelet Ø = D	mm	1.1	
Solder eyelet Ø tolerance	mm	+ 0,1	

Accessories

Note: Refer to the Accessories chapter for additional accessories.

Screwdriver		Order No.
	SDIS 0.4X2.5X75	9008370000
	SDS 0.4X2.5X75	9009030000

Ordering data

Solder pin length		1.5 mm	3.5 mm		
Colour		Black	Black		
Pitch 3.50 mm					
Pol.	L1 (inch)	Qty.	Order No.	Order No.	
2	3.50	0.138	71	1870640000	1825640000
3	7.00	0.276	49	1870650000	1825650000
4	10.50	0.413	37	1870660000	1825660000
5	14.00	0.551	30	1870670000	1825670000
6	17.50	0.689	25	1870680000	1825680000
7	21.00	0.827	21	1870690000	1825690000
8	24.50	0.965	19	1870700000	1825700000
9	28.00	1.102	17	1870710000	1825710000
10	31.50	1.240	15	1870720000	1825720000
11	35.00	1.378	14	1870730000	1825730000
12	38.50	1.516	12	1870740000	1825740000
13	42.00	1.654	11	1870750000	1870350000
14	45.50	1.791	11	1870760000	1870360000
15	49.00	1.929	10	1870770000	1870370000
16	52.50	2.067	9	1870790000	1870510000
17	56.00	2.205	9	1870800000	1870520000
18	59.50	2.343	8	1870830000	1870540000
19	63.00	2.480	8	1870840000	1870560000
20	66.50	2.618	7	1870850000	1870570000
21	70.00	2.756	7	1870860000	1870600000
22	73.50	2.894	7	1870870000	1870610000
23	77.00	3.031	6	1870880000	1870620000
24	80.50	3.169	6	1870890000	1870630000

Representative deratings curve

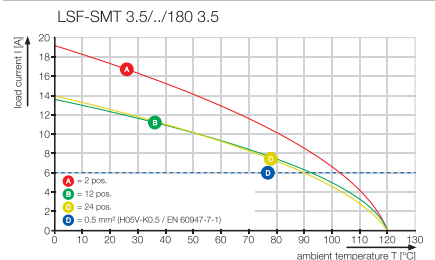

LSF-SMT 3.5/././180 Tape

Reflow-compatible PCB Terminal



Dimensioned drawing

Ordering data

Solder pin length		1.5 mm	3.5 mm
Colour		Black	Black
Pitch		3.50 mm	
Pol.	L1 (inch)	Qty.	Order No.
2	3.50	175	1874490000 1874510000
3	7.00	175	1874300000 1874520000
4	10.50	175	1874280000 1874540000
5	14.00	175	1874310000 1874560000
6	17.50	175	1874320000 1874590000
7	21.00	175	1874340000 1874600000
8	24.50	175	1874350000 1874610000
9	28.00	175	1874370000 1874620000
10	31.50	175	1874380000 1874640000
11	35.00	175	1874400000 1874660000
12	38.50	175	1874420000 1874680000

Tape widths: 32, 44, 56, 72, 88

Additional deratings curves

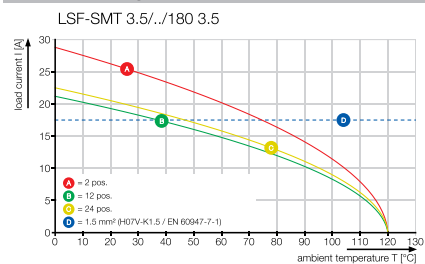

LSF-SMT 3.81../90

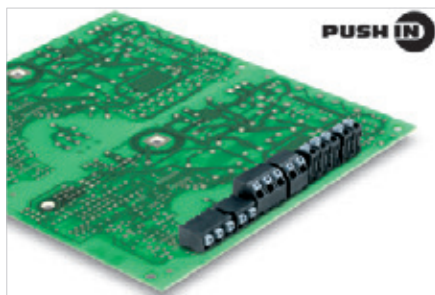

PCB terminal for fully automatic assembly, in 3.81 mm pitch, for THR reflow soldering (SMT) and wave soldering.

- PUSH IN wire connection, for wire cross-sections up to 1.5 mm².
- Form and dimensional stability provided by the LCP insulating material.
- Conductor inserted and slider operated in same direction (TOP).
- Packaged in tube or tape-on-reel.
- Pin lengths optimised to 1.5 mm or 3.5 mm.
- Wire outlet direction of 90°.

Technical data

In compliance with IEC 60664-1 / IEC 61984			
Clamping range, max.	mm ²	0.13...1.5	
Solid core H05(07) V-U	mm ²	0.2...1.5	
Stranded H07 V-R			
Flexible H05(07) V-K	mm ²	0.2...1.5	
Flexible with ferrule	mm ²	0.25...1.5	
Ferrule with plastic collar	mm ²	0.25...0.75	
Stripping length	mm	8	
Screwdriver blade	mm		
According to norm			
Tightening torque range	Nm		
Rated current, max.	A	17.5	17.5
At ambient temperature		20°C	40°C
For conductor cross-section	mm ²	1.5	
Overvoltage category		III	III II
Pollution severity		3	2 2
Rated voltage	V	160	160 320
Rated impulse voltage	kV	2.5	2.5 2.5
UL / CUL (Use Group)		B	C D
Rated voltage	V	300	300
Rated current	A	12	10
AWG conductor	AWG	24-16	
CSA (Use Group)		B	C D
Rated voltage	V	300	300
Rated current	A	10	10
AWG conductor	AWG	24-16	
General data			
Type of insulation material		LCP GF	
UL 94 flammability rating		V-0	
Contact base material		Copper alloy	
Material of contact surface		tinned	
Pin dimensions = d	mm	0.35 x 0.8	
Solder eyelet Ø = D	mm	1.1	
Solder eyelet Ø tolerance	mm	+ 0,1	

Product data

IEC: 320 V / 17.5 A / 0.2 - 1.5 mm²
 UL: 300 V / 12 A / AWG 24 - 16

For additional articles and information, refer to catalog.weidmuller.com

Note:

- Additional push button colours on request
- Rated current related to rated cross-section & min. No. of poles.
- Wire end ferrule without plastic collar to DIN 46228/1
- P on drawing = pitch
- Operating force of slider max. 40 N
- Rated data refer only to the component itself. Clearance and creepage distances to other components are to be designed in accordance with the relevant application standards.
- Crimping shape „A“ for wire end ferrules with PZ 6/5 crimping tool are recommended for the largest cable sizes.

LSF-SMT 3.81../90

Reflow-compatible PCB Terminal



Dimensioned drawing

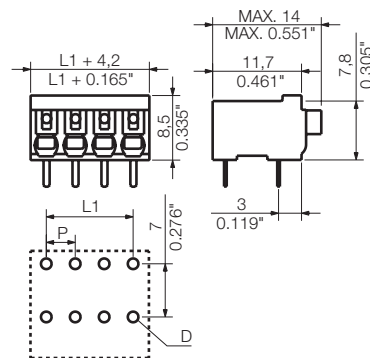

Accessories

Note: Refer to the Accessories chapter for additional accessories.

Screwdriver		Order No.
	SDIS 0.4X2.5X75	9008370000
	SDS 0.4X2.5X75	9009030000

Ordering data

Solder pin length	1.5 mm		3.5 mm		
	Black		Black		
Pitch	3.81 mm				
Pol.	L1 (inch)	Qty.	Order No.	Order No.	
2	3.81	0.150	69	1869360000	1824620000
3	7.62	0.300	46	1869370000	1824630000
4	11.43	0.450	35	1869380000	1824640000
5	15.24	0.600	28	1869390000	1824650000
6	19.05	0.750	23	1869400000	1824660000
7	22.86	0.900	20	1869410000	1824690000
8	26.67	1.050	17	1869420000	1824700000
9	30.48	1.200	15	1869430000	1824710000
10	34.29	1.350	14	1869440000	1824720000
11	38.10	1.500	13	1869450000	1824730000
12	41.91	1.650	12	1869460000	1825300000
13	45.72	1.800	11	1869470000	1871200000
14	49.53	1.950	10	1869480000	1871210000
15	53.34	2.100	9	1869500000	1871220000
16	57.15	2.250	9	1869510000	1871230000
17	60.96	2.400	8	1869520000	1871240000
18	64.77	2.550	8	1869530000	1871250000
19	68.58	2.700	7	1869540000	1871260000
20	72.39	2.850	7	1869550000	1871270000
21	76.20	3.000	6	1869560000	1871280000
22	80.01	3.150	6	1869570000	1871290000
23	83.82	3.300	6	1869580000	1871300000
24	87.63	3.450	6	1869590000	1871310000

Representative deratings curve

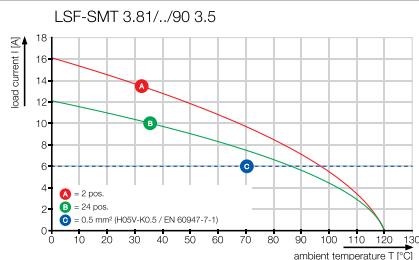

LSF-SMT 3.81../90 Tape

Reflow-compatible PCB Terminal



Dimensioned drawing

Ordering data

Solder pin length		1.5 mm	3.5 mm
Colour		Black	Black
Pitch		3.81 mm	
Pol.	L1 (inch)	Qty.	Order No.
2	3.81	0.150	265 1875170000
3	7.62	0.300	265 1875230000
4	11.43	0.450	265 1875240000
5	15.24	0.600	265 1875250000
6	19.05	0.750	265 1875260000
7	22.86	0.900	265 1875270000
8	26.67	1.050	265 1875280000
9	30.48	1.200	265 1875290000
10	34.29	1.350	265 1875300000
11	38.10	1.500	265 1875310000

Tape widths: 32, 44, 56, 72, 88

Additional deratings curves

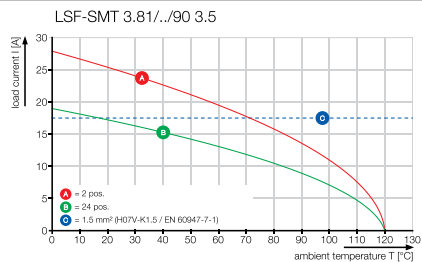

LSF-SMT 3.81../135

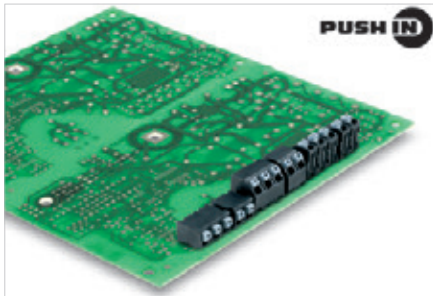

PCB terminal for fully automatic assembly, in 3.81 mm pitch, for THR reflow soldering (SMT) and wave soldering.

- PUSH IN wire connection, for wire cross-sections up to 1.5 mm².
- Form and dimensional stability provided by the LCP insulating material.
- Conductor inserted and slider operated in same direction (TOP).
- Packaged in tube or tape-on-reel.
- Pin lengths optimised to 1.5 mm or 3.5 mm.
- Wire outlet direction of 135°.

Technical data

In compliance with IEC 60664-1 / IEC 61984			
Clamping range, max.	mm ²	0.13...1.5	
Solid core H05(07) V-U	mm ²	0.2...1.5	
Stranded H07 V-R			
Flexible H05(07) V-K	mm ²	0.2...1.5	
Flexible with ferrule	mm ²	0.25...1.5	
Ferrule with plastic collar	mm ²	0.25...0.75	
Stripping length	mm	8	
Screwdriver blade	mm		
According to norm			
Tightening torque range	Nm		
Rated current, max.	A	17.5	17.5
At ambient temperature		20°C	40°C
For conductor cross-section	mm ²	1.5	
Overvoltage category		III	III II
Pollution severity		3	2 2
Rated voltage	V	160	160 320
Rated impulse voltage	kV	2.5	2.5 2.5
UL / CUL (Use Group)		B	C D
Rated voltage	V	300	300
Rated current	A	12	10
AWG conductor	AWG	24-16	
CSA (Use Group)		B	C D
Rated voltage	V	300	300
Rated current	A	10	10
AWG conductor	AWG	24-16	
General data			
Type of insulation material		LCP GF	
UL 94 flammability rating		V-0	
Contact base material		Copper alloy	
Material of contact surface		tinned	
Pin dimensions = d	mm	0.35 x 0.8	
Solder eyelet Ø = D	mm	1.1	
Solder eyelet Ø tolerance	mm	+ 0,1	

Product data

IEC: 320 V / 17.5 A / 0.2 - 1.5 mm²
 UL: 300 V / 12 A / AWG 24 - 16

For additional articles and information, refer to catalog.weidmueller.com

Note:

- Additional push button colours on request
- Rated current related to rated cross-section & min. No. of poles.
- Wire end ferrule without plastic collar to DIN 46228/1
- P on drawing = pitch
- Operating force of slider max. 40 N
- Rated data refer only to the component itself. Clearance and creepage distances to other components are to be designed in accordance with the relevant application standards.
- Crimping shape „A“ for wire end ferrules with PZ 6/5 crimping tool are recommended for the largest cable sizes.

Accessories

Note: Refer to the Accessories chapter for additional accessories.

Screwdriver		Order No.
	SDIS 0.4X2.5X75	9008370000
	SDS 0.4X2.5X75	9009030000

LSF-SMT 3.81../135

Reflow-compatible PCB Terminal



Dimensioned drawing

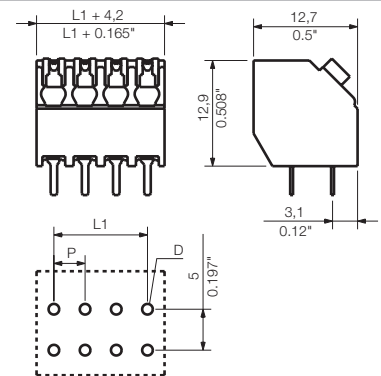

Ordering data

Solder pin length	1.5 mm		3.5 mm		
	Black		Black		
Pitch	3.81 mm				
Pol.	L1 (inch)	Qty.	Order No.	Order No.	
2	3.81	0.150	69	1885410000	1885880000
3	7.62	0.300	46	1885420000	1885890000
4	11.43	0.450	35	1885430000	1885900000
5	15.24	0.600	28	1885440000	1885910000
6	19.05	0.750	23	1885450000	1885920000
7	22.86	0.900	20	1885460000	1885930000
8	26.67	1.050	17	1885470000	1885940000
9	30.48	1.200	15	1885480000	1885950000
10	34.29	1.350	14	1885490000	1885960000
11	38.10	1.500	13	1885510000	1885970000
12	41.91	1.650	12	1885520000	1885980000
13	45.72	1.800	11	1885530000	1885990000
14	49.53	1.950	10	1885540000	1886000000
15	53.34	2.100	9	1885550000	1886010000
16	57.15	2.250	9	1885560000	1886020000
17	60.96	2.400	8	1885570000	1886030000
18	64.77	2.550	8	1885580000	1886040000
19	68.58	2.700	7	1885590000	1886050000
20	72.39	2.850	7	1885600000	1886060000
21	76.20	3.000	6	1885610000	1886070000
22	80.01	3.150	6	1885620000	1886080000
23	83.82	3.300	6	1885630000	1886090000
24	87.63	3.450	6	1885640000	1886100000

Representative deratings curve

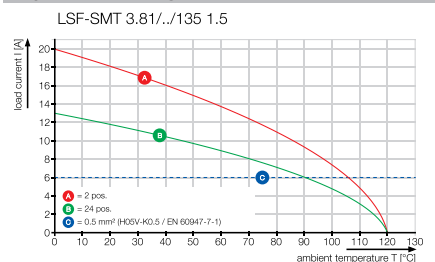

LSF-SMT 3.81../135 Tape

Reflow-compatible PCB Terminal



Dimensioned drawing

Ordering data

Solder pin length		1.5 mm	3.5 mm		
Colour		Black	Black		
Pitch		3.81 mm			
Pol.	L1 (inch)	Qty.	Order No.		
2	3.81	0.150	175	1888450000	1888320000
3	7.62	0.300	190	1888460000	1888330000
4	11.43	0.450	190	1888470000	1888340000
5	15.24	0.600	190	1888480000	1888380000
6	19.05	0.750	190	1888490000	1888390000
7	22.86	0.900	190	1888500000	1888400000
8	26.67	1.050	190	1888510000	1888410000
9	30.48	1.200	190	1888520000	1888420000
10	34.29	1.350	190	1888530000	1888430000
11	38.10	1.500	190	1888540000	1888440000

Tape widths: 32, 44, 56, 72, 88

Additional deratings curves

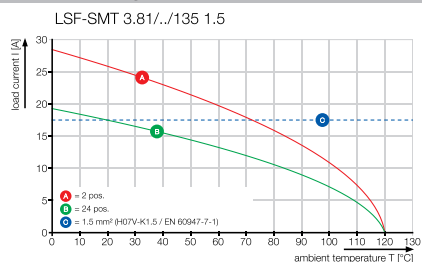

LSF-SMT 3.81../180

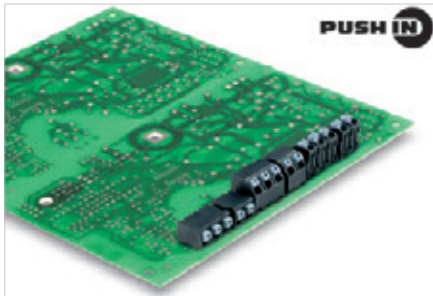

PCB terminal for fully automatic assembly, in 3.81 mm pitch, for THR reflow soldering (SMT) and wave soldering.

- PUSH IN wire connection, for wire cross-sections up to 1.5 mm².
- Form and dimensional stability provided by the LCP insulating material.
- Conductor inserted and slider operated in same direction (TOP).
- Packaged in tube or tape-on-reel.
- Pin lengths optimised to 1.5 mm or 3.5 mm.
- Wire outlet direction of 180°.

Technical data

In compliance with IEC 60664-1 / IEC 61984			
Clamping range, max.	mm ²	0.13...1.5	
Solid core H05(07) V-U	mm ²	0.2...1.5	
Stranded H07 V-R			
Flexible H05(07) V-K	mm ²	0.2...1.5	
Flexible with ferrule	mm ²	0.25...1.5	
Ferrule with plastic collar	mm ²	0.25...0.75	
Stripping length	mm	8	
Screwdriver blade	mm		
According to norm			
Tightening torque range	Nm		
Rated current, max.	A	17.5	17.5
At ambient temperature		20°C	40°C
For conductor cross-section	mm ²	1.5	
Overvoltage category		III	III II
Pollution severity		3	2 2
Rated voltage	V	160	160 320
Rated impulse voltage	kV	2.5	2.5 2.5
UL / CUL (Use Group)		B	C D
Rated voltage	V	300	300
Rated current	A	12	10
AWG conductor	AWG	24-16	
CSA (Use Group)		B	C D
Rated voltage	V	300	300
Rated current	A	10	10
AWG conductor	AWG	24-16	
General data			
Type of insulation material		LCP GF	
UL 94 flammability rating		V-0	
Contact base material		Copper alloy	
Material of contact surface		tinned	
Pin dimensions = d	mm	0.35 x 0.8	
Solder eyelet Ø = D	mm	1.1	
Solder eyelet Ø tolerance	mm	+ 0,1	

Product data

IEC: 320 V / 17.5 A / 0.2 - 1.5 mm²
 UL: 300 V / 12 A / AWG 24 - 16

For additional articles and information, refer to catalog.weidmueller.com

Note:

- Additional push button colours on request
- Rated current related to rated cross-section & min. No. of poles.
- Wire end ferrule without plastic collar to DIN 46228/1
- P on drawing = pitch
- Operating force of slider max. 40 N
- Rated data refer only to the component itself. Clearance and creepage distances to other components are to be designed in accordance with the relevant application standards.
- Crimping shape „A“ for wire end ferrules with PZ 6/5 crimping tool are recommended for the largest cable sizes.

LSF-SMT 3.81../180

Reflow-compatible PCB Terminal



Dimensioned drawing

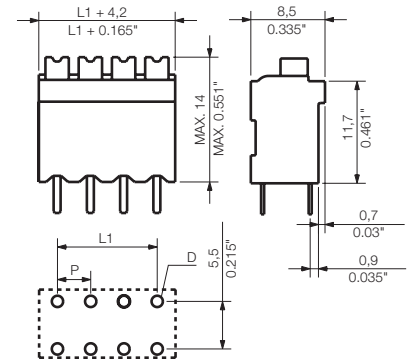

Accessories

Note: Refer to the Accessories chapter for additional accessories.

Screwdriver		Order No.
	SDIS 0.4X2.5X75	9008370000
	SDS 0.4X2.5X75	9009030000

Ordering data

Solder pin length		1.5 mm	3.5 mm		
Colour		Black	Black		
Pitch 3.81 mm					
Pol.	L1	(inch)	Qty.	Order No.	Order No.
2	3.81	0.150	69	1869890000	1825790000
3	7.62	0.300	46	1869900000	1825800000
4	11.43	0.450	35	1869910000	1825810000
5	15.24	0.600	28	1869920000	1825820000
6	19.05	0.750	23	1869930000	1825830000
7	22.86	0.900	20	1869940000	1825840000
8	26.67	1.050	17	1869950000	1825850000
9	30.48	1.200	15	1869960000	1825870000
10	34.29	1.350	14	1869970000	1825880000
11	38.10	1.500	13	1870000000	1825890000
12	41.91	1.650	12	1870010000	1825920000
13	45.72	1.800	11	1870020000	1870900000
14	49.53	1.950	10	1870030000	1870910000
15	53.34	2.100	9	1870040000	1870920000
16	57.15	2.250	9	1870050000	1870930000
17	60.96	2.400	8	1870060000	1870940000
18	64.77	2.550	8	1870070000	1870950000
19	68.58	2.700	7	1870080000	1870960000
20	72.39	2.850	7	1870090000	1870970000
21	76.20	3.000	6	1870100000	1870980000
22	80.01	3.150	6	1870110000	1870990000
23	83.82	3.300	6	1870120000	1871000000
24	87.63	3.450	6	1870130000	1871010000

Representative deratings curve

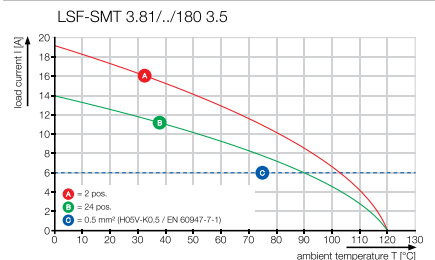

LSF-SMT 3.81../180 Tape

Reflow-compatible PCB Terminal



Dimensioned drawing

Ordering data

Solder pin length		1.5 mm	3.5 mm
Colour		Black	Black
Pitch		3.81 mm	
Pol.	L1 (inch)	Qty.	Order No.
2	3.81	175	1875320000
3	7.62	175	1875330000
4	11.43	175	1875340000
5	15.24	175	1875350000
6	19.05	175	1875360000
7	22.86	175	1875370000
8	26.67	175	1875380000
9	30.48	175	1875390000
10	34.29	175	1875400000
11	38.10	175	1875410000

Tape widths: 32, 44, 56, 72, 88

Additional deratings curves

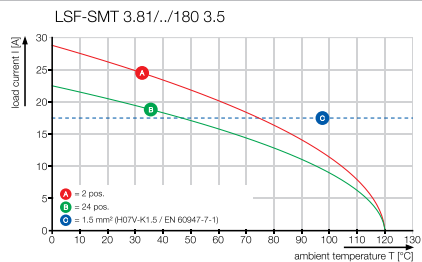

LSF-SMT 5.00/./90

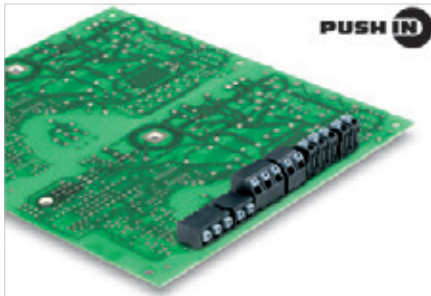

PCB terminal for fully automatic assembly, in 5.00 mm pitch, for THR reflow soldering (SMT) and wave soldering.

- PUSH IN wire connection, for wire cross-sections up to 1.5 mm². Form and dimensional stability provided by the LCP insulating material.
- Conductor inserted and slider operated in same direction (TOP).
- Packaged in tube or tape-on-reel.
- Pin lengths optimised to 1.5 mm or 3.5 mm.
- Wire outlet direction of 90°.

Technical data

In compliance with IEC 60664-1 / IEC 61984			
Clamping range, max.	mm ²	0.13...1.5	
Solid core H05(07) V-U	mm ²	0.2...1.5	
Stranded H07 V-R			
Flexible H05(07) V-K	mm ²	0.2...1.5	
Flexible with ferrule	mm ²	0.25...1.5	
Ferrule with plastic collar	mm ²	0.25...0.75	
Stripping length	mm	8	
Screwdriver blade	mm		
According to norm			
Tightening torque range	Nm		
Rated current, max.	A	17.5	17.5
At ambient temperature		20°C	40°C
For conductor cross-section	mm ²	1.5	
Overtoltage category		III	III II
Pollution severity		3	2 2
Rated voltage	V	250	320 500
Rated impulse voltage	kV	4	4 4
UL / CUL (Use Group)		B	C D
Rated voltage	V	300	300
Rated current	A	12	10
AWG conductor	AWG	24-16	
CSA (Use Group)		B	C D
Rated voltage	V	300	300
Rated current	A	10	10
AWG conductor	AWG	24-16	
General data			
Type of insulation material		LCP GF	
UL 94 flammability rating		V-0	
Contact base material		Copper alloy	
Material of contact surface		tinned	
Pin dimensions = d	mm	0.35 x 0.8	
Solder eyelet Ø = D	mm	1.1	
Solder eyelet Ø tolerance	mm	+ 0,1	

Product data

IEC: 500 V / 17.5 A / 0.2 - 1.5 mm²
 UL: 300 V / 12 A / AWG 24 - 16

For additional articles and information, refer to catalog.weidmueller.com

Note:

- Additional push button colours on request
- Rated current related to rated cross-section & min. No. of poles.
- Wire end ferrule without plastic collar to DIN 46228/1
- P on drawing = pitch
- Operating force of slider max. 40 N
- Rated data refer only to the component itself. Clearance and creepage distances to other components are to be designed in accordance with the relevant application standards.
- Crimping shape „A“ for wire end ferrules with PZ 6/5 crimping tool are recommended for the largest cable sizes.

Accessories

Note: Refer to the Accessories chapter for additional accessories.

Screwdriver		Order No.
	SDIS 0.4X2.5X75	9008370000
	SDS 0.4X2.5X75	9009030000

LSF-SMT 5.00/./90

Reflow-compatible PCB Terminal



Dimensioned drawing

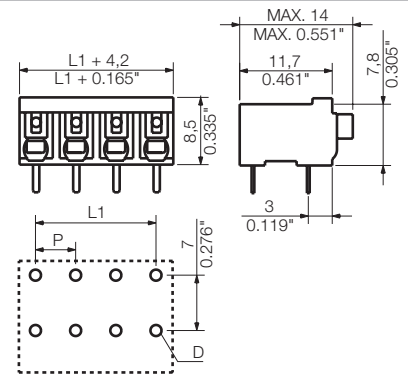

Ordering data

Solder pin length		1.5 mm	3.5 mm		
Colour		Black	Black		
Pitch 5.00 mm					
Pol.	L1	(inch)	Qty.	Order No.	Order No.
2	5.00	0.197	60	1869600000	1824740000
3	10.00	0.394	39	1869610000	1824750000
4	15.00	0.591	28	1869620000	1824760000
5	20.00	0.787	22	1869630000	1824770000
6	25.00	0.984	18	1869640000	1824780000
7	30.00	1.181	16	1869650000	1824790000
8	35.00	1.378	14	1869660000	1824800000

Representative deratings curve

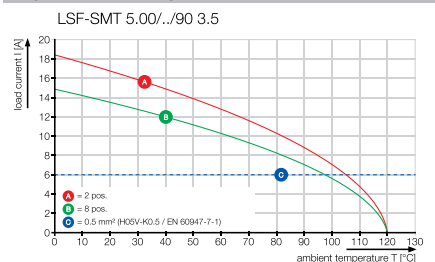

LSF-SMT 5.00/./90 Tape

Reflow-compatible PCB Terminal



Dimensioned drawing

Ordering data

Solder pin length		1.5 mm	3.5 mm		
Colour		Black	Black		
Pitch		5.00 mm			
Pol.	L1 (inch)	Qty.	Order No.		
2	5.00	0.197	265	1876240000	1876430000
3	10.00	0.394	265	1876260000	1876510000
4	15.00	0.591	265	1876270000	1876530000
5	20.00	0.787	265	1876280000	1876550000
6	25.00	0.984	265	1876300000	1876560000
7	30.00	1.181	265	1876330000	1876540000
8	35.00	1.378	265	1876350000	1876520000

Tape widths: 32, 44, 56, 72, 88

Additional deratings curves

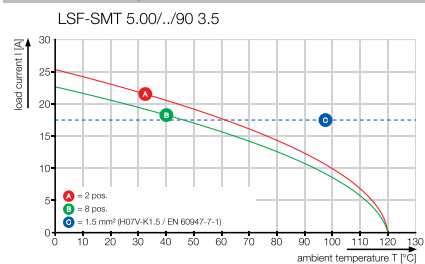

LSF-SMT 5.00/././135

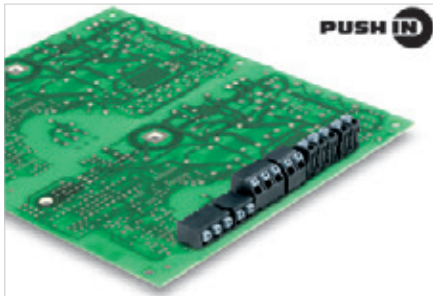

PCB terminal for fully automatic assembly, in 5.00 mm pitch, for THR reflow soldering (SMT) and wave soldering.

- PUSH IN wire connection, for wire cross-sections up to 1.5 mm².
- Form and dimensional stability provided by the LCP insulating material.
- Conductor inserted and slider operated in same direction (TOP).
- Packaged in tube or tape-on-reel.
- Pin lengths optimised to 1.5 mm or 3.5 mm.
- Wire outlet direction of 135°.

Technical data

In compliance with IEC 60664-1 / IEC 61984			
Clamping range, max.	mm ²	0.13...1.5	
Solid core H05(07) V-U	mm ²	0.2...1.5	
Stranded H07 V-R			
Flexible H05(07) V-K	mm ²	0.2...1.5	
Flexible with ferrule	mm ²	0.25...1.5	
Ferrule with plastic collar	mm ²	0.25...0.75	
Stripping length	mm	8	
Screwdriver blade	mm		
According to norm			
Tightening torque range	Nm		
Rated current, max.	A	17.5	17.5
At ambient temperature		20°C	40°C
For conductor cross-section	mm ²	1.5	
Overtolerance category		III	III II
Pollution severity		3	2 2
Rated voltage	V	250	320 500
Rated impulse voltage	kV	4	4 4
UL / CUL (Use Group)		B	C D
Rated voltage	V	300	300
Rated current	A	12	10
AWG conductor	AWG	24-16	
CSA (Use Group)		B	C D
Rated voltage	V	300	300
Rated current	A	10	10
AWG conductor	AWG	24-16	
General data			
Type of insulation material		LCP GF	
UL 94 flammability rating		V-0	
Contact base material		Copper alloy	
Material of contact surface		tinned	
Pin dimensions = d	mm	0.35 x 0.8	
Solder eyelet Ø = D	mm	1.1	
Solder eyelet Ø tolerance	mm	+ 0,1	

Product data

IEC: 500 V / 17.5 A / 0.2 - 1.5 mm²
 UL: 300 V / 12 A / AWG 24 - 16

For additional articles and information, refer to catalog.weidmuller.com

Note:

- Additional push button colours on request
- Rated current related to rated cross-section & min. No. of poles.
- Wire end ferrule without plastic collar to DIN 46228/1
- P on drawing = pitch
- Operating force of slider max. 40 N
- Rated data refer only to the component itself. Clearance and creepage distances to other components are to be designed in accordance with the relevant application standards.
- Crimping shape „A“ for wire end ferrules with PZ 6/5 crimping tool are recommended for the largest cable sizes.

Accessories

Note: Refer to the Accessories chapter for additional accessories.

Screwdriver		Order No.
	SDIS 0.4X2.5X75	9008370000
	SDS 0.4X2.5X75	9009030000

LSF-SMT 5.00/././135

Reflow-compatible PCB Terminal



Dimensioned drawing

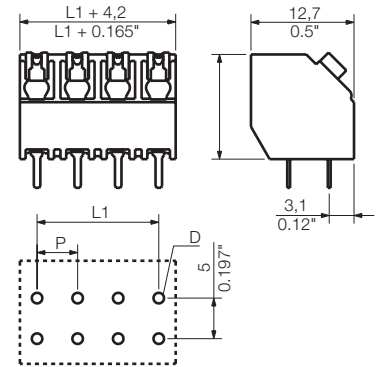

Ordering data

Solder pin length		1.5 mm	3.5 mm		
Colour		Black	Black		
Pitch 5.00 mm					
Pol.	L1	(inch)	Qty.	Order No.	Order No.
2	5.00	0.197	60	1884530000	1884340000
3	10.00	0.394	39	1884540000	1884370000
4	15.00	0.591	28	1884550000	1884380000
5	20.00	0.787	22	1884560000	1884390000
6	25.00	0.984	18	1884570000	1884400000
7	30.00	1.181	16	1884580000	1884410000
8	35.00	1.378	14	1884590000	1884420000
9	40.00	1.575	12	1884600000	1884430000
10	45.00	1.772	11	1884610000	1884440000
11	50.00	1.969	10	1884620000	1884450000
12	55.00	2.165	9	1884630000	1884460000
13	60.00	2.362	8	1884640000	1884470000
14	65.00	2.559	8	1884650000	1884480000
15	70.00	2.756	7	1884660000	1884490000
16	75.00	2.953	6	1884670000	1884500000

Representative deratings curve

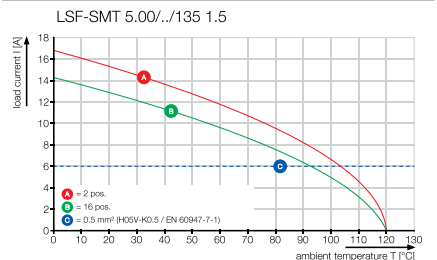

LSF-SMT 5.00/./135 Tape

Reflow-compatible PCB Terminal



Dimensioned drawing

Ordering data

Solder pin length		1.5 mm	3.5 mm
Colour		Black	Black
Pitch		5.00 mm	
Pol.	L1 (inch)	Qty.	Order No.
2	5.00	190	1888570000 1888640000
3	10.00	190	1888580000 1888650000
4	15.00	190	1888590000 1888660000
5	20.00	190	1888600000 1888670000
6	25.00	190	1888610000 1888680000
7	30.00	190	1888620000 1888690000
8	35.00	190	1888630000 1888700000

Tape widths: 32, 44, 56, 72, 88

Additional deratings curves

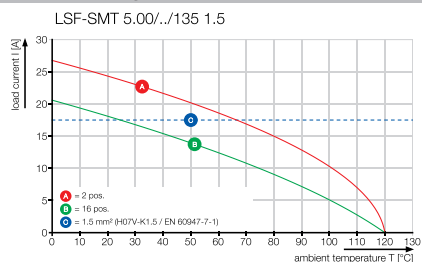

LSF-SMT 5.00/./180

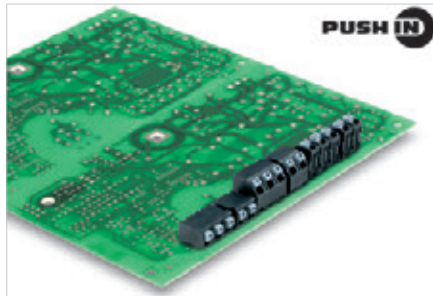

PCB terminal for fully automatic assembly, in 5.00 mm pitch, for THR reflow soldering (SMT) and wave soldering.

- PUSH IN wire connection, for wire cross-sections up to 1.5 mm².
- Form and dimensional stability provided by the LCP insulating material.
- Conductor inserted and slider operated in same direction (TOP).
- Packaged in tube or tape-on-reel.
- Pin lengths optimised to 1.5 mm or 3.5 mm.
- Wire outlet direction of 180°.

Technical data

In compliance with IEC 60664-1 / IEC 61984

Clamping range, max.	mm ²	0.13...1.5
Solid core H05(07) V-U	mm²	0.2...1.5
Stranded H07 V-R		
Flexible H05(07) V-K	mm ²	0.2...1.5
Flexible with ferrule	mm ²	0.25...1.5
Ferrule with plastic collar	mm ²	0.25...0.75
Stripping length	mm	8
Screwdriver blade	mm	
According to norm		
Tightening torque range	Nm	
Rated current, max.	A	17.5 17.5
At ambient temperature	20°C	40°C
For conductor cross-section	mm ²	1.5
Overtoltage category		III III II
Pollution severity		3 2 2
Rated voltage	V	250 320 500
Rated impulse voltage	kV	4 4 4
UL / CUL (Use Group)		B C D
Rated voltage	V	300 300
Rated current	A	12 10
AWG conductor	AWG	24-16
CSA (Use Group)		B C D
Rated voltage	V	300 300
Rated current	A	10 10
AWG conductor	AWG	24-16
General data		
Type of insulation material		LCP GF
UL 94 flammability rating		V-0
Contact base material		Copper alloy
Material of contact surface		tinned
Pin dimensions = d	mm	0.35 x 0.8
Solder eyelet Ø = D	mm	1.1
Solder eyelet Ø tolerance	mm	+ 0,1

Product data

IEC: 500 V / 17.5 A / 0.2 - 1.5 mm²
 UL: 300 V / 12 A / AWG 24 - 16

For additional articles and information, refer to catalog.weidmueller.com

Note:

- Additional push button colours on request
- Rated current related to rated cross-section & min. No. of poles.
- Wire end ferrule without plastic collar to DIN 46228/1
- P on drawing = pitch
- Operating force of slider max. 40 N
- Rated data refer only to the component itself. Clearance and creepage distances to other components are to be designed in accordance with the relevant application standards.
- Crimping shape „A“ for wire end ferrules with PZ 6/5 crimping tool are recommended for the largest cable sizes.

Accessories

Note: Refer to the Accessories chapter for additional accessories.

Screwdriver		Order No.
	SDIS 0.4X2.5X75	9008370000
	SDS 0.4X2.5X75	9009030000

LSF-SMT 5.00/./180

Reflow-compatible PCB Terminal



Dimensioned drawing

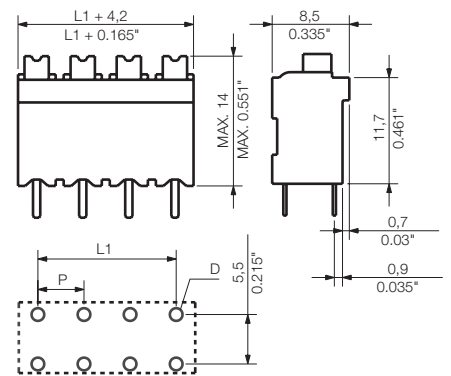

Ordering data

Solder pin length		1.5 mm	3.5 mm		
Colour		Black	Black		
Pitch 5.00 mm					
Pol.	L1	(inch)	Qty.	Order No.	Order No.
2	5.00	0.197	60	1870140000	1825960000
3	10.00	0.394	39	1870150000	1825970000
4	15.00	0.591	28	1870160000	1825980000
5	20.00	0.787	22	1870170000	1825990000
6	25.00	0.984	18	1870180000	1826000000
7	30.00	1.181	16	1870190000	1826010000
8	35.00	1.378	14	1870200000	1826020000

Representative deratings curve

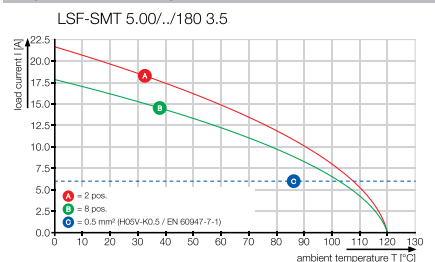

LSF-SMT 5.00/./180 Tape

Reflow-compatible PCB Terminal



Dimensioned drawing

Ordering data

Solder pin length		1.5 mm	3.5 mm
Colour		Black	Black
Pitch		5.00 mm	
Pol.	L1 (inch)	Qty.	Order No.
2	5.00	175	1876020000 1876110000
3	10.00	175	1876030000 1876130000
4	15.00	175	1876050000 1876140000
5	20.00	175	1876060000 1876160000
6	25.00	175	1876070000 1876200000
7	30.00	175	1876080000 1876220000
8	35.00	175	1876090000 1876230000

Tape widths: 32, 44, 56, 72, 88

Additional deratings curves

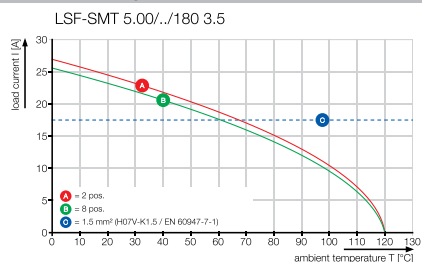

LSF-SMT 5.08/./90

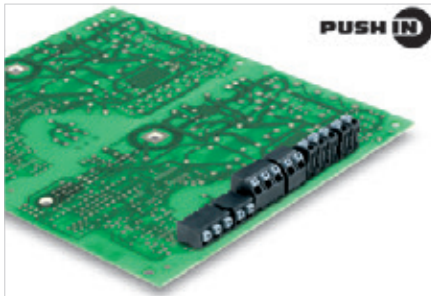

PCB terminal for fully automatic assembly, in 5.08 mm pitch, for THR reflow soldering (SMT) and wave soldering.

- PUSH IN wire connection, for wire cross-sections up to 1.5 mm².
- Form and dimensional stability provided by the LCP insulating material.
- Conductor inserted and slider operated in same direction (TOP).
- Packaged in tube or tape-on-reel.
- Pin lengths optimised to 1.5 mm or 3.5 mm.
- Wire outlet direction of 90°.

Technical data

In compliance with IEC 60664-1 / IEC 61984

Clamping range, max.	mm ²	0.13...1.5
Solid core H05(07) V-U	mm²	0.2...1.5
Stranded H07 V-R		
Flexible H05(07) V-K	mm ²	0.2...1.5
Flexible with ferrule	mm ²	0.25...1.5
Ferrule with plastic collar	mm ²	0.25...0.75
Stripping length	mm	8
Screwdriver blade	mm	
According to norm		
Tightening torque range	Nm	
Rated current, max.	A	17.5 17.5
At ambient temperature	20°C	40°C
For conductor cross-section	mm ²	1.5
Overtoltage category		III III II
Pollution severity		3 2 2
Rated voltage	V	250 320 500
Rated impulse voltage	kV	4 4 4
UL / CUL (Use Group)		B C D
Rated voltage	V	300 300
Rated current	A	12 10
AWG conductor	AWG	24-16
CSA (Use Group)		B C D
Rated voltage	V	300 300
Rated current	A	10 10
AWG conductor	AWG	24-16
General data		
Type of insulation material		LCP GF
UL 94 flammability rating		V-0
Contact base material		Copper alloy
Material of contact surface		tinned
Pin dimensions = d	mm	0.35 x 0.8
Solder eyelet Ø = D	mm	1.1
Solder eyelet Ø tolerance	mm	+ 0,1

Product data

IEC: 500 V / 17.5 A / 0.2 - 1.5 mm²
 UL: 300 V / 12 A / AWG 24 - 16

For additional articles and information, refer to catalog.weidmueller.com

Note:

- Additional push button colours on request
- Rated current related to rated cross-section & min. No. of poles.
- Wire end ferrule without plastic collar to DIN 46228/1
- P on drawing = pitch
- Operating force of slider max. 40 N
- Rated data refer only to the component itself. Clearance and creepage distances to other components are to be designed in accordance with the relevant application standards.
- Crimping shape „A“ for wire end ferrules with PZ 6/5 crimping tool are recommended for the largest cable sizes.

LSF-SMT 5.08/./90

Reflow-compatible PCB Terminal



Dimensioned drawing

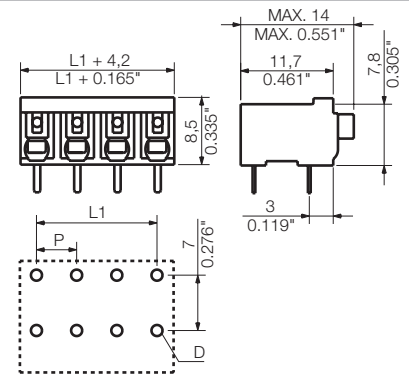

Accessories

Note: Refer to the Accessories chapter for additional accessories.

Screwdriver		Order No.
	SDIS 0.4X2.5X75	9008370000
	SDS 0.4X2.5X75	9009030000

Ordering data

Solder pin length	1.5 mm		3.5 mm		
	Colour	Black	Black	Black	
Pitch	5.08 mm				
Pol.	L1	(inch)	Qty.	Order No.	Order No.
2	5.08	0.200	59	1869670000	1824810000
3	10.16	0.400	38	1869680000	1824820000
4	15.24	0.600	28	1869690000	1824830000
5	20.32	0.800	22	1869700000	1824840000
6	25.40	1.000	18	1869710000	1824850000
7	30.48	1.200	15	1869720000	1824860000
8	35.56	1.400	13	1869730000	1824870000

Representative deratings curve

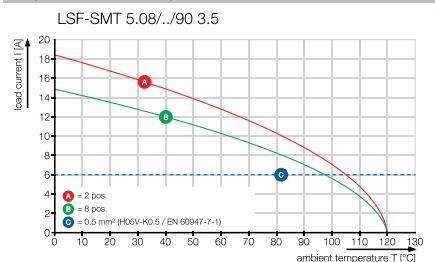

LSF-SMT 5.08/./90 Tape

Reflow-compatible PCB Terminal



Dimensioned drawing

Ordering data

Solder pin length		1.5 mm	3.5 mm		
Colour		Black	Black		
Pitch		5.08 mm			
Pol.	L1 (inch)	Qty.	Order No.		
2	5.08	0.200	265	1876480000	1876470000
3	10.16	0.400	265	1876440000	1876420000
4	15.24	0.600	265	1878520000	1876310000
5	20.32	0.800	265	1876210000	1876190000
6	25.40	1.000	265	1876150000	1876120000
7	30.48	1.200	265	1875720000	1875690000
8	35.56	1.400	265	1875520000	1875510000

Tape widths: 32, 44, 56, 72, 88

Additional deratings curves

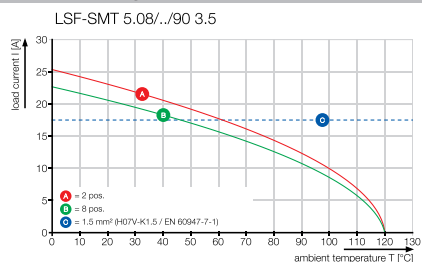

LSF-SMT 5.08/./135

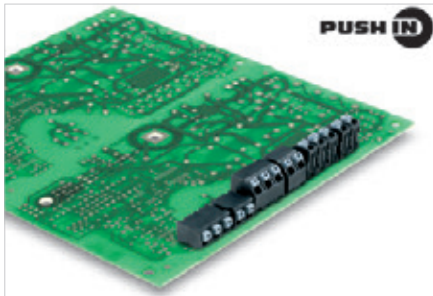

PCB terminal for fully automatic assembly, in 5.08 mm pitch, for THR reflow soldering (SMT) and wave soldering.

- PUSH IN wire connection, for wire cross-sections up to 1.5 mm².
- Form and dimensional stability provided by the LCP insulating material.
- Conductor inserted and slider operated in same direction (TOP).
- Packaged in tube or tape-on-reel.
- Pin lengths optimised to 1.5 mm or 3.5 mm.
- Wire outlet direction of 135°.

Technical data

In compliance with IEC 60664-1 / IEC 61984			
Clamping range, max.	mm ²	0.13...1.5	
Solid core H05(07) V-U	mm ²	0.2...1.5	
Stranded H07 V-R			
Flexible H05(07) V-K	mm ²	0.2...1.5	
Flexible with ferrule	mm ²	0.25...1.5	
Ferrule with plastic collar	mm ²	0.25...0.75	
Stripping length	mm	8	
Screwdriver blade	mm		
According to norm			
Tightening torque range	Nm		
Rated current, max.	A	17.5	17.5
At ambient temperature		20°C	40°C
For conductor cross-section	mm ²	1.5	
Overtolerance category		III	III II
Pollution severity		3	2 2
Rated voltage	V	250	320 500
Rated impulse voltage	kV	4	4 4
UL / CUL (Use Group)		B	C D
Rated voltage	V	300	300
Rated current	A	12	10
AWG conductor	AWG	24-16	
CSA (Use Group)		B	C D
Rated voltage	V	300	300
Rated current	A	10	10
AWG conductor	AWG	24-16	
General data			
Type of insulation material		LCP GF	
UL 94 flammability rating		V-0	
Contact base material		Copper alloy	
Material of contact surface		tinned	
Pin dimensions = d	mm	0.35 x 0.8	
Solder eyelet Ø = D	mm	1.1	
Solder eyelet Ø tolerance	mm	+ 0,1	

Product data

IEC: 500 V / 17.5 A / 0.2 - 1.5 mm²
 UL: 300 V / 12 A / AWG 24 - 16

For additional articles and information, refer to catalog.weidmuller.com

Note:

- Additional push button colours on request
- Rated current related to rated cross-section & min. No. of poles.
- Wire end ferrule without plastic collar to DIN 46228/1
- P on drawing = pitch
- Operating force of slider max. 40 N
- Rated data refer only to the component itself. Clearance and creepage distances to other components are to be designed in accordance with the relevant application standards.
- Crimping shape „A“ for wire end ferrules with PZ 6/5 crimping tool are recommended for the largest cable sizes.

Accessories

Note: Refer to the Accessories chapter for additional accessories.

Screwdriver		Order No.
	SDIS 0.4X2.5X75	9008370000
	SDS 0.4X2.5X75	9009030000

LSF-SMT 5.08/./135

Reflow-compatible PCB Terminal



Dimensioned drawing

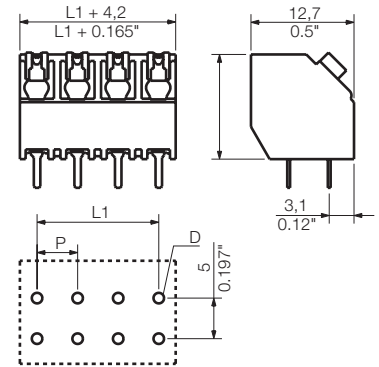

Ordering data

Solder pin length		1.5 mm	3.5 mm		
Colour		Black	Black		
Pitch 5.08 mm					
Pol.	L1	(inch)	Qty.	Order No.	Order No.
2	5.08	0.200	59	1884730000	1885020000
3	10.16	0.400	38	1884740000	1885030000
4	15.24	0.600	28	1884750000	1885040000
5	20.32	0.800	22	1884760000	1885050000
6	25.40	1.000	18	1884770000	1885060000
7	30.48	1.200	15	1884780000	1885070000
8	35.56	1.400	13	1884790000	1885080000
9	40.64	1.600	12	1884800000	1885090000
10	45.72	1.800	11	1884810000	1885100000
11	50.80	2.000	10	1884820000	1885110000
12	55.88	2.200	9	1884830000	1885120000
13	60.96	2.400	8	1884840000	1885130000
14	66.04	2.600	7	1884850000	1885140000
15	71.12	2.800	7	1884860000	1885150000
16	76.20	3.000	6	1884870000	1885160000

Representative deratings curve

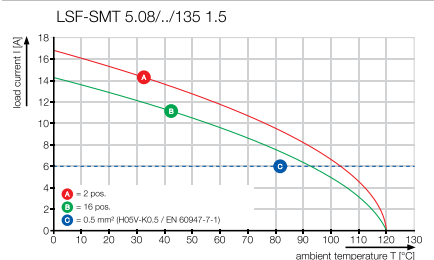

LSF-SMT 5.08/./135 Tape

Reflow-compatible PCB Terminal



Dimensioned drawing

Ordering data

Solder pin length		1.5 mm	3.5 mm
Colour		Black	Black
Pitch		5.08 mm	
Pol.	L1 (inch)	Qty.	Order No.
2	5.08	190	1888710000 1888780000
3	10.16	190	1888720000 1888790000
4	15.24	190	1888730000 1888810000
5	20.32	190	1888740000 1888830000
6	25.40	190	1888750000 1888840000
7	30.48	190	1888760000 1888870000
8	35.56	190	1888770000 1888880000

Tape widths: 32, 44, 56, 72, 88

Additional deratings curves

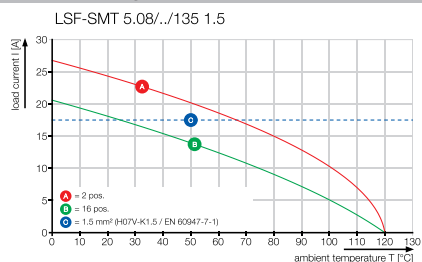

LSF-SMT 5.08/./180

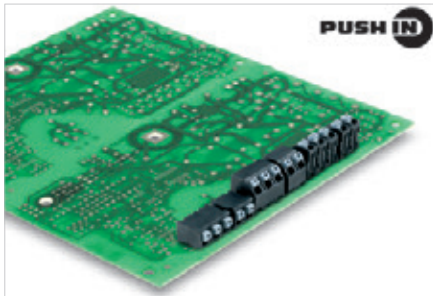

PCB terminal for fully automatic assembly, in 5.08 mm pitch, for THR reflow soldering (SMT) and wave soldering.

- PUSH IN wire connection, for wire cross-sections up to 1.5 mm².
- Form and dimensional stability provided by the LCP insulating material.
- Conductor inserted and slider operated in same direction (TOP).
- Packaged in tube or tape-on-reel.
- Pin lengths optimised to 1.5 mm or 3.5 mm.
- Wire outlet direction of 180°.

Technical data

In compliance with IEC 60664-1 / IEC 61984

Clamping range, max.	mm ²	0.13...1.5
Solid core H05(07) V-U	mm²	0.2...1.5
Stranded H07 V-R		
Flexible H05(07) V-K	mm ²	0.2...1.5
Flexible with ferrule	mm ²	0.25...1.5
Ferrule with plastic collar	mm ²	0.25...0.75
Stripping length	mm	8
Screwdriver blade	mm	
According to norm		
Tightening torque range	Nm	
Rated current, max.	A	17.5 17.5
At ambient temperature	20°C	40°C
For conductor cross-section	mm ²	1.5
Overtoltage category		III III II
Pollution severity		3 2 2
Rated voltage	V	250 320 500
Rated impulse voltage	kV	4 4 4
UL / CUL (Use Group)		B C D
Rated voltage	V	300 300
Rated current	A	12 10
AWG conductor	AWG	24-16
CSA (Use Group)		B C D
Rated voltage	V	300 300
Rated current	A	10 10
AWG conductor	AWG	24-16
General data		
Type of insulation material		LCP GF
UL 94 flammability rating		V-0
Contact base material		Copper alloy
Material of contact surface		tinned
Pin dimensions = d	mm	0.35 x 0.8
Solder eyelet Ø = D	mm	1.1
Solder eyelet Ø tolerance	mm	+ 0,1

Product data

IEC: 500 V / 17.5 A / 0.2 - 1.5 mm²
 UL: 300 V / 12 A / AWG 24 - 16

For additional articles and information, refer to catalog.weidmueller.com

Note:

- Additional push button colours on request
- Rated current related to rated cross-section & min. No. of poles.
- Wire end ferrule without plastic collar to DIN 46228/1
- P on drawing = pitch
- Operating force of slider max. 40 N
- Rated data refer only to the component itself. Clearance and creepage distances to other components are to be designed in accordance with the relevant application standards.
- Crimping shape „A“ for wire end ferrules with PZ 6/5 crimping tool are recommended for the largest cable sizes.

Accessories

Note: Refer to the Accessories chapter for additional accessories.

Screwdriver		Order No.
	SDIS 0.4X2.5X75	9008370000
	SDS 0.4X2.5X75	9009030000

LSF-SMT 5.08/./180

Reflow-compatible PCB Terminal

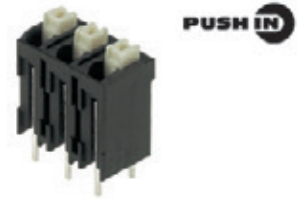

Dimensioned drawing

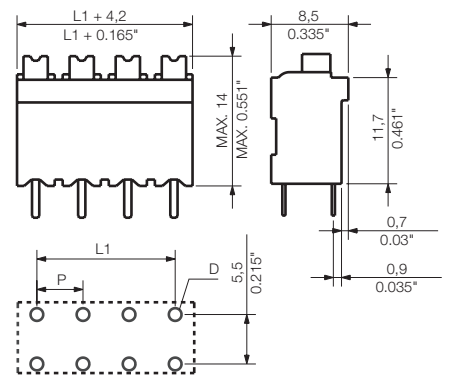

Ordering data

Solder pin length		1.5 mm	3.5 mm		
Colour		Black	Black		
Pitch 5.08 mm					
Pol.	L1	(inch)	Qty.	Order No.	Order No.
2	5.08	0.200	59	1870210000	1826040000
3	10.16	0.400	38	1870220000	1826060000
4	15.24	0.600	28	1870230000	1826070000
5	20.32	0.800	22	1870240000	1826080000
6	25.40	1.000	18	1870250000	1826100000
7	30.48	1.200	15	1870260000	1826110000
8	35.56	1.400	13	1870270000	1826120000

Representative deratings curve

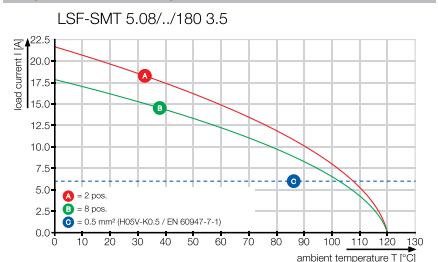

LSF-SMT 5.08/./180 Tape

Reflow-compatible PCB Terminal



Dimensioned drawing

Ordering data

Solder pin length		1.5 mm	3.5 mm
Colour		Black	Black
Pitch		5.08 mm	
Pol.	L1 (inch)	Qty.	Order No.
2	5.08	0.200	175 1876500000 1876490000
3	10.16	0.400	175 1876460000 1876450000
4	15.24	0.600	175 1876410000 1876360000
5	20.32	0.800	175 1876290000 1876250000
6	25.40	1.000	175 1876180000 1876170000
7	30.48	1.200	175 1876100000 1875750000
8	35.56	1.400	175 1875610000 1875580000

Tape widths: 32, 44, 56, 72, 88

Additional deratings curves

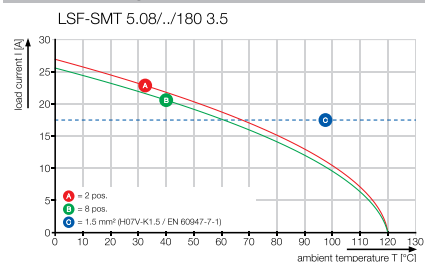

LSF-SMT 7.50/./90

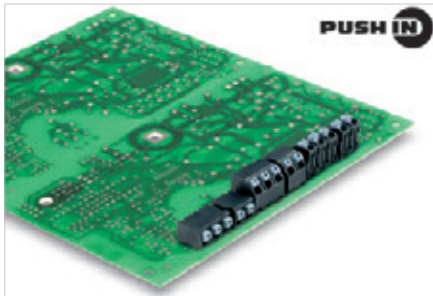

PCB terminal for fully automatic assembly, in 7.50 mm pitch, for THR reflow soldering (SMT) and wave soldering.

- PUSH IN wire connection, for wire cross-sections up to 1.5 mm².
- Form and dimensional stability provided by the LCP insulating material.
- Conductor inserted and slider operated in same direction (TOP).
- Packaged in tube or tape-on-reel.
- Pin lengths optimised to 1.5 mm or 3.5 mm.
- Wire outlet direction of 90°.

Technical data

In compliance with IEC 60664-1 / IEC 61984

Clamping range, max.	mm ²	0.13...1.5
Solid core H05(07) V-U	mm²	0.2...1.5
Stranded H07 V-R		
Flexible H05(07) V-K	mm ²	0.2...1.5
Flexible with ferrule	mm ²	0.25...1.5
Ferrule with plastic collar	mm ²	0.25...0.75
Stripping length	mm	8
Screwdriver blade	mm	
According to norm		
Tightening torque range	Nm	
Rated current, max.	A	17.5 17.5
At ambient temperature	20°C	40°C
For conductor cross-section	mm ²	1.5
Overtoltage category		III III II
Pollution severity		3 2 2
Rated voltage	V	500 630 800
Rated impulse voltage	kV	6 6 6
UL / CUL (Use Group)	B C D	
Rated voltage	V	300 150 300
Rated current	A	12 10 10
AWG conductor	AWG	24-16
CSA (Use Group)	B C D	
Rated voltage	V	300 150 300
Rated current	A	10 10 10
AWG conductor	AWG	24-16
General data		
Type of insulation material		LCP GF
UL 94 flammability rating		V-0
Contact base material		Copper alloy
Material of contact surface		tinned
Pin dimensions = d	mm	0.35 x 0.8
Solder eyelet Ø = D	mm	1.1
Solder eyelet Ø tolerance	mm	+ 0,1

Product data

IEC: 800 V / 17.5 A / 0.2 - 1.5 mm²
 UL: 300 V / 12 A / AWG 24 - 16

For additional articles and information, refer to catalog.weidmueller.com

Note:

- Additional push button colours on request
- Rated current related to rated cross-section & min. No. of poles.
- Wire end ferrule without plastic collar to DIN 46228/1
- P on drawing = pitch
- Operating force of slider max. 40 N
- Rated data refer only to the component itself. Clearance and creepage distances to other components are to be designed in accordance with the relevant application standards.
- Crimping shape „A“ for wire end ferrules with PZ 6/5 crimping tool are recommended for the largest cable sizes.

LSF-SMT 7.50/./90

Reflow-compatible PCB Terminal



Dimensioned drawing

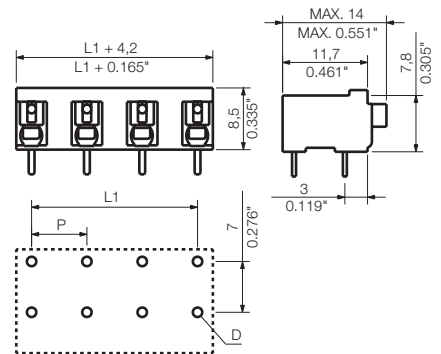

Accessories

Note: Refer to the Accessories chapter for additional accessories.

Screwdriver		Order No.
	SDIS 0.4X2.5X75	9008370000
	SDS 0.4X2.5X75	9009030000

Ordering data

Solder pin length		1.5 mm	3.5 mm		
Colour		Black	Black		
Pitch 7.50 mm					
Pol.	L1	(inch)	Qty.	Order No.	Order No.
2	7.50	0.295	47	1869740000	1824880000
3	15.00	0.591	28	1869750000	1824890000
4	22.50	0.886	20	1869760000	1824900000
5	30.00	1.181	16	1869770000	1824910000
6	37.50	1.476	13	1869780000	1824920000
7	45.00	1.772	11	1869790000	1824930000
8	52.50	2.067	9	1869800000	1824940000

Representative deratings curve

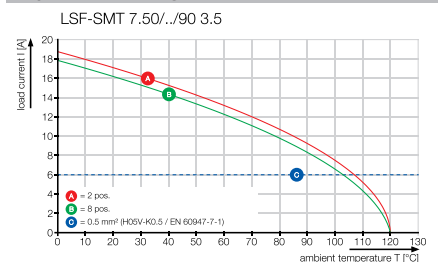

LSF-SMT 7.50/./90 Tape

Reflow-compatible PCB Terminal



Dimensioned drawing

Ordering data

Solder pin length		1.5 mm	3.5 mm
Colour		Black	Black
Pitch		7.50 mm	
Pol.	L1 (inch)	Qty.	Order No.
2	7.50 0.295	265	1875480000 1875470000
3	15.00 0.591	265	1875440000 1875430000
4	22.50 0.886	265	1875040000 1875020000
5	30.00 1.181	265	1874980000 1874960000
6	37.50 1.476	265	1874910000 1874880000

Tape widths: 32, 44, 56, 72, 88

Additional deratings curves

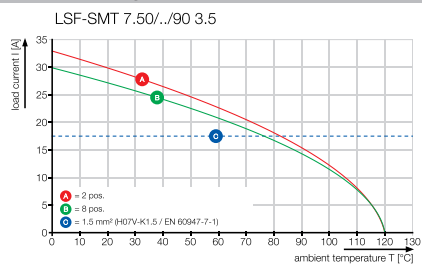

LSF-SMT 7.50/././135

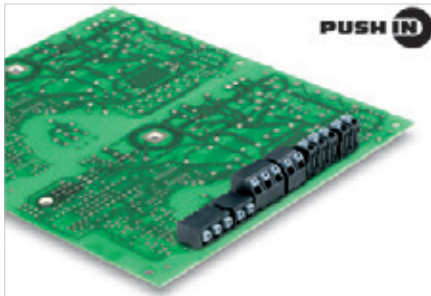

PCB terminal for fully automatic assembly, in 7.50 mm pitch, for THR reflow soldering (SMT) and wave soldering.

- PUSH IN wire connection, for wire cross-sections up to 1.5 mm².
- Form and dimensional stability provided by the LCP insulating material.
- Conductor inserted and slider operated in same direction (TOP).
- Packaged in tube or tape-on-reel.
- Pin lengths optimised to 1.5 mm or 3.5 mm.
- Wire outlet direction of 135°.

Technical data

In compliance with IEC 60664-1 / IEC 61984

Clamping range, max.	mm ²	0.13...1.5
Solid core H05(07) V-U	mm ²	0.2...1.5
Stranded H07 V-R		
Flexible H05(07) V-K	mm ²	0.2...1.5
Flexible with ferrule	mm ²	0.25...1.5
Ferrule with plastic collar	mm ²	0.25...0.75
Stripping length	mm	8
Screwdriver blade	mm	
According to norm		
Tightening torque range	Nm	
Rated current, max.	A	17.5 17.5
At ambient temperature	20°C	40°C
For conductor cross-section	mm ²	1.5
Overtoltage category		III III II
Pollution severity		3 2 2
Rated voltage	V	500 630 800
Rated impulse voltage	kV	6 6 6
UL / CUL (Use Group)		B C D
Rated voltage	V	300 300
Rated current	A	12 10
AWG conductor	AWG	24-16
CSA (Use Group)		B C D
Rated voltage	V	300 300
Rated current	A	10 10
AWG conductor	AWG	24-16
General data		
Type of insulation material		LCP GF
UL 94 flammability rating		V-0
Contact base material		Copper alloy
Material of contact surface		tinned
Pin dimensions = d	mm	0.35 x 0.8
Solder eyelet Ø = D	mm	1.1
Solder eyelet Ø tolerance	mm	+ 0,1

Product data

IEC: 800 V / 17.5 A / 0.2 - 1.5 mm²
 UL: 300 V / 12 A / AWG 24 - 16

For additional articles and information, refer to catalog.weidmueller.com

Note:

- Additional push button colours on request
- Rated current related to rated cross-section & min. No. of poles.
- Wire end ferrule without plastic collar to DIN 46228/1
- P on drawing = pitch
- Operating force of slider max. 40 N
- Rated data refer only to the component itself. Clearance and creepage distances to other components are to be designed in accordance with the relevant application standards.
- Crimping shape „A“ for wire end ferrules with PZ 6/5 crimping tool are recommended for the largest cable sizes.

Accessories

Note: Refer to the Accessories chapter for additional accessories.

Screwdriver		Order No.
	SDIS 0.4X2.5X75	9008370000
	SDS 0.4X2.5X75	9009030000

LSF-SMT 7.50/././135

Reflow-compatible PCB Terminal



Dimensioned drawing

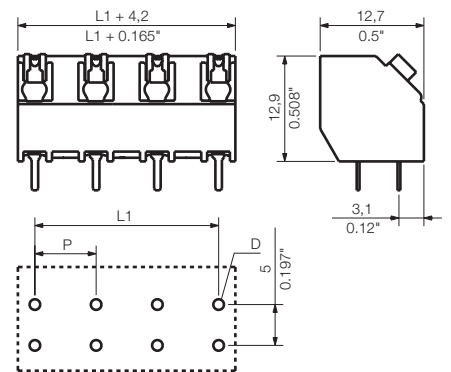

Ordering data

Solder pin length		1.5 mm	3.5 mm		
Colour		Black	Black		
Pitch 7.50 mm					
Pol.	L1	(inch)	Qty.	Order No.	Order No.
2	7.50	0.295	47	1884880000	1886110000
3	15.00	0.591	28	1884890000	1886120000
4	22.50	0.886	20	1884900000	1886130000
5	30.00	1.181	16	1884910000	1886140000
6	37.50	1.476	13	1884920000	1886150000
7	45.00	1.772	11	1884930000	1886160000
8	52.50	2.067	9	1884940000	1886170000

Representative deratings curve

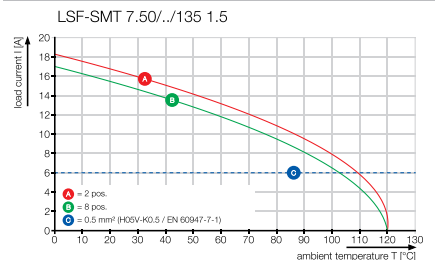

LSF-SMT 7.50/./135 Tape

Reflow-compatible PCB Terminal



Dimensioned drawing

Ordering data

Solder pin length		1.5 mm	3.5 mm
Colour		Black	Black
Pitch		7.50 mm	
Pol.	L1 (inch)	Qty.	Order No.
2	7.50	190	1888890000
3	15.00	190	1888910000
4	22.50	190	1888930000
5	30.00	190	1888940000
6	37.50	190	1888950000

Tape widths: 32, 44, 56, 72, 88

Additional deratings curves

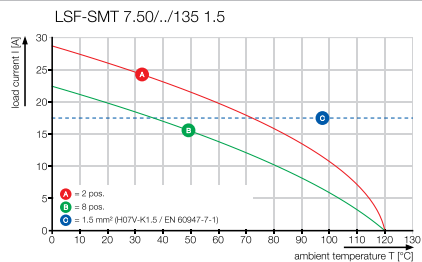

LSF-SMT 7.50/./180

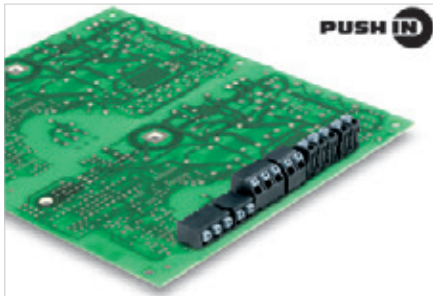

PCB terminal for fully automatic assembly, in 7.50 mm pitch, for THR reflow soldering (SMT) and wave soldering.

- PUSH IN wire connection, for wire cross-sections up to 1.5 mm².
- Form and dimensional stability provided by the LCP insulating material.
- Conductor inserted and slider operated in same direction (TOP).
- Packaged in tube or tape-on-reel.
- Pin lengths optimised to 1.5 mm or 3.5 mm.
- Wire outlet direction of 180°.

Technical data

In compliance with IEC 60664-1 / IEC 61984

Clamping range, max.	mm ²	0.13...1.5
Solid core H05(07) V-U	mm²	0.2...1.5
Stranded H07 V-R		
Flexible H05(07) V-K	mm ²	0.2...1.5
Flexible with ferrule	mm ²	0.25...1.5
Ferrule with plastic collar	mm ²	0.25...0.75
Stripping length	mm	8
Screwdriver blade	mm	
According to norm		
Tightening torque range	Nm	
Rated current, max.	A	17.5 17.5
At ambient temperature	20°C	40°C
For conductor cross-section	mm ²	1.5
Overtoltage category		III III II
Pollution severity		3 2 2
Rated voltage	V	500 630 800
Rated impulse voltage	kV	6 6 6
UL / CUL (Use Group)	B C D	
Rated voltage	V	300 150 300
Rated current	A	12 10 10
AWG conductor	AWG	24-16
CSA (Use Group)	B C D	
Rated voltage	V	300 150 300
Rated current	A	10 10 10
AWG conductor	AWG	24-16
General data		
Type of insulation material		LCP GF
UL 94 flammability rating		V-0
Contact base material		Copper alloy
Material of contact surface		tinned
Pin dimensions = d	mm	0.35 x 0.8
Solder eyelet Ø = D	mm	1.1
Solder eyelet Ø tolerance	mm	+ 0,1

Product data

IEC: 800 V / 17.5 A / 0.2 - 1.5 mm²
 UL: 300 V / 12 A / AWG 24 - 16

For additional articles and information, refer to catalog.weidmueller.com

Note:

- Additional push button colours on request
- Rated current related to rated cross-section & min. No. of poles.
- Wire end ferrule without plastic collar to DIN 46228/1
- P on drawing = pitch
- Operating force of slider max. 40 N
- Rated data refer only to the component itself. Clearance and creepage distances to other components are to be designed in accordance with the relevant application standards.
- Crimping shape „A“ for wire end ferrules with PZ 6/5 crimping tool are recommended for the largest cable sizes.

LSF-SMT 7.50/./180

Reflow-compatible PCB Terminal

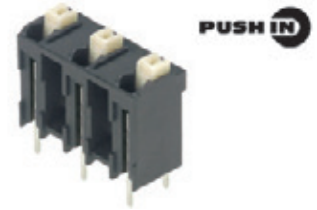

Dimensioned drawing

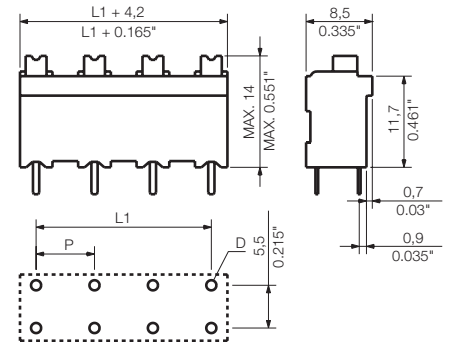

Accessories

Note: Refer to the Accessories chapter for additional accessories.

Screwdriver		Order No.
	SDIS 0.4X2.5X75	9008370000
	SDS 0.4X2.5X75	9009030000

Ordering data

Solder pin length	1.5 mm		3.5 mm		
	Black		Black		
Pitch	7.50 mm				
Pol.	L1	(inch)	Qty.	Order No.	Order No.
2	7.50	0.295	47	1870280000	1826130000
3	15.00	0.591	28	1870290000	1826140000
4	22.50	0.886	20	1870300000	1826150000
5	30.00	1.181	16	1870310000	1826160000
6	37.50	1.476	13	1870320000	1826170000
7	45.00	1.772	11	1870330000	1826180000
8	52.50	2.067	9	1870340000	1826190000

Representative deratings curve

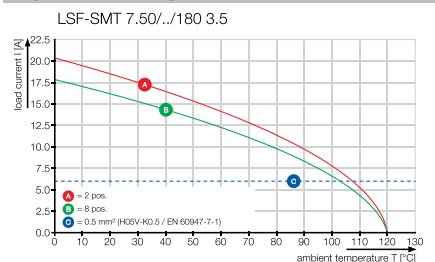

LSF-SMT 7.50/./180 Tape

Reflow-compatible PCB Terminal



Dimensioned drawing

Ordering data

Solder pin length		1.5 mm	3.5 mm
Colour		Black	Black
Pitch		7.50 mm	
Pol.	L1 (inch)	Qty.	Order No.
2	7.50 0.295	175	1875500000 1875490000
3	15.00 0.591	175	1875460000 1875450000
4	22.50 0.886	175	1875090000 1875060000
5	30.00 1.181	175	1875010000 1875000000
6	37.50 1.476	175	1874950000 1874920000

Tape widths: 32, 44, 56, 72, 88

Additional deratings curves

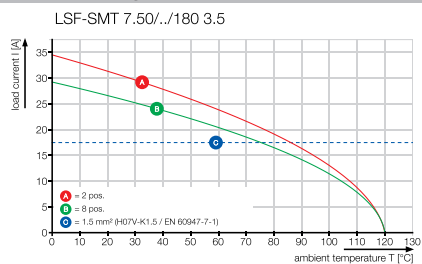

LSF-SMT 7.62/./90

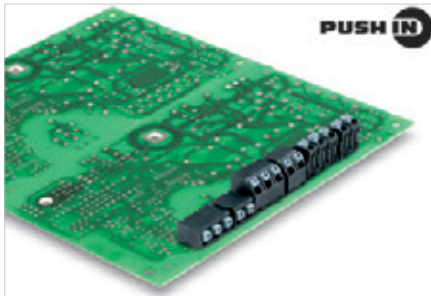

PCB terminal for fully automatic assembly, in 7.62 mm pitch, for THR reflow soldering (SMT) and wave soldering.

- PUSH IN wire connection, for wire cross-sections up to 1.5 mm².
- Form and dimensional stability provided by the LCP insulating material.
- Conductor inserted and slider operated in same direction (TOP).
- Packaged in tube or tape-on-reel.
- Pin lengths optimised to 1.5 mm or 3.5 mm.
- Wire outlet direction of 90°.

Technical data

In compliance with IEC 60664-1 / IEC 61984

Clamping range, max.	mm ²	0.13...1.5
Solid core H05(07) V-U	mm²	0.2...1.5
Stranded H07 V-R		
Flexible H05(07) V-K	mm ²	0.2...1.5
Flexible with ferrule	mm ²	0.25...1.5
Ferrule with plastic collar	mm ²	0.25...0.75
Stripping length	mm	8
Screwdriver blade	mm	
According to norm		
Tightening torque range	Nm	
Rated current, max.	A	17.5 17.5
At ambient temperature	20°C	40°C
For conductor cross-section	mm ²	1.5
Overtoltage category		III III II
Pollution severity		3 2 2
Rated voltage	V	500 630 800
Rated impulse voltage	kV	6 6 6
UL / CUL (Use Group)	B C D	
Rated voltage	V	300 150 300
Rated current	A	12 10 10
AWG conductor	AWG	24-16
CSA (Use Group)	B C D	
Rated voltage	V	300 150 300
Rated current	A	10 10 10
AWG conductor	AWG	24-16
General data		
Type of insulation material		LCP GF
UL 94 flammability rating		V-0
Contact base material		Copper alloy
Material of contact surface		tinned
Pin dimensions = d	mm	0.35 x 0.8
Solder eyelet Ø = D	mm	1.1
Solder eyelet Ø tolerance	mm	+ 0,1

Product data

IEC: 800 V / 17.5 A / 0.2 - 1.5 mm²
 UL: 300 V / 12 A / AWG 24 - 16

For additional articles and information, refer to catalog.weidmueller.com

Note:

- Additional push button colours on request
- Rated current related to rated cross-section & min. No. of poles.
- Wire end ferrule without plastic collar to DIN 46228/1
- P on drawing = pitch
- Operating force of slider max. 40 N
- Rated data refer only to the component itself. Clearance and creepage distances to other components are to be designed in accordance with the relevant application standards.
- Crimping shape „A“ for wire end ferrules with PZ 6/5 crimping tool are recommended for the largest cable sizes.

LSF-SMT 7.62/./90

Reflow-compatible PCB Terminal



Dimensioned drawing

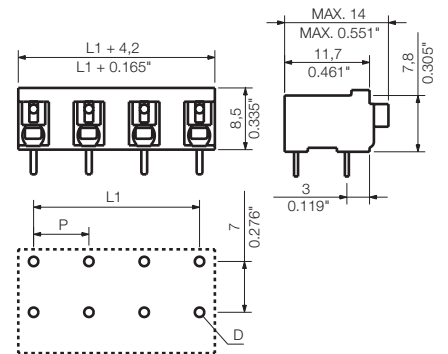

Accessories

Note: Refer to the Accessories chapter for additional accessories.

Screwdriver		Order No.
	SDIS 0.4X2.5X75	9008370000
	SDS 0.4X2.5X75	9009030000

Ordering data

Solder pin length		1.5 mm	3.5 mm		
Colour		Black	Black		
Pitch 7.62 mm					
Pol.	L1	(inch)	Qty.	Order No.	Order No.
2	7.62	0.300	46	1869260000	1824950000
3	15.24	0.600	28	1869270000	1824960000
4	22.86	0.900	20	1869280000	1824970000
5	30.48	1.200	15	1869290000	1824980000
6	38.10	1.500	13	1869300000	1824990000
7	45.72	1.800	11	1869310000	1825000000
8	53.34	2.100	9	1869320000	1825010000

Representative deratings curve

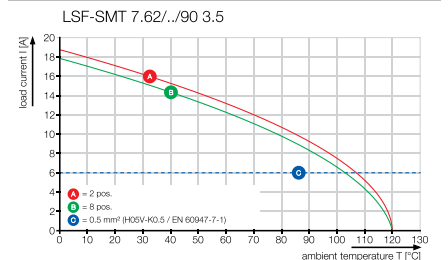

LSF-SMT 7.62/./90 Tape

Reflow-compatible PCB Terminal



Dimensioned drawing

Ordering data

Solder pin length		1.5 mm	3.5 mm		
Colour		Black	Black		
Pitch		7.62 mm			
Pol.	L1 (inch)	Qty.	Order No.		
2	7.62	0.300	265	1874700000	1874670000
3	15.24	0.600	265	1874570000	1874550000
4	22.86	0.900	265	1874480000	1874470000
5	30.48	1.200	265	1874430000	1874410000
6	38.10	1.500	265	1874330000	1874290000

Tape widths: 32, 44, 56, 72, 88

Additional deratings curves

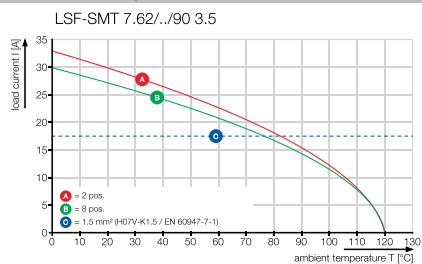

LSF-SMT 7.62/././135

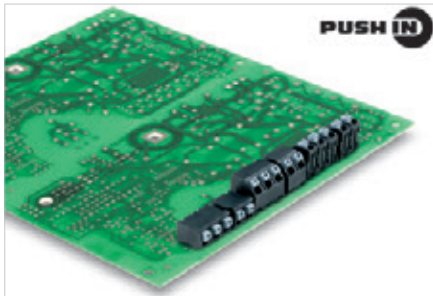

PCB terminal for fully automatic assembly, in 7.62 mm pitch, for THR reflow soldering (SMT) and wave soldering.

- PUSH IN wire connection, for wire cross-sections up to 1.5 mm².
- Form and dimensional stability provided by the LCP insulating material.
- Conductor inserted and slider operated in same direction (TOP).
- Packaged in tube or tape-on-reel.
- Pin lengths optimised to 1.5 mm or 3.5 mm.
- Wire outlet direction of 135°.

Technical data

In compliance with IEC 60664-1 / IEC 61984

Clamping range, max.	mm ²	0.13...1.5
Solid core H05(07) V-U	mm ²	0.2...1.5
Stranded H07 V-R		
Flexible H05(07) V-K	mm ²	0.2...1.5
Flexible with ferrule	mm ²	0.25...1.5
Ferrule with plastic collar	mm ²	0.25...0.75
Stripping length	mm	8
Screwdriver blade	mm	
According to norm		
Tightening torque range	Nm	
Rated current, max.	A	17.5 17.5
At ambient temperature	20°C	40°C
For conductor cross-section	mm ²	1.5
Overtoltage category		III III II
Pollution severity		3 2 2
Rated voltage	V	500 630 800
Rated impulse voltage	kV	6 6 6
UL / CUL (Use Group)		B C D
Rated voltage	V	300 300
Rated current	A	12 10
AWG conductor	AWG	24-16
CSA (Use Group)		B C D
Rated voltage	V	300 300
Rated current	A	10 10
AWG conductor	AWG	24-16
General data		
Type of insulation material		LCP GF
UL 94 flammability rating		V-0
Contact base material		Copper alloy
Material of contact surface		tinned
Pin dimensions = d	mm	0.35 x 0.8
Solder eyelet Ø = D	mm	1.1
Solder eyelet Ø tolerance	mm	+ 0,1

Product data

IEC: 800 V / 17.5 A / 0.2 - 1.5 mm²
 UL: 300 V / 12 A / AWG 24 - 16

For additional articles and information, refer to catalog.weidmueller.com

Note:

- Additional push button colours on request
- Rated current related to rated cross-section & min. No. of poles.
- Wire end ferrule without plastic collar to DIN 46228/1
- P on drawing = pitch
- Operating force of slider max. 40 N
- Rated data refer only to the component itself. Clearance and creepage distances to other components are to be designed in accordance with the relevant application standards.
- Crimping shape „A“ for wire end ferrules with PZ 6/5 crimping tool are recommended for the largest cable sizes.

Accessories

Note: Refer to the Accessories chapter for additional accessories.

Screwdriver		Order No.
	SDIS 0.4X2.5X75	9008370000
	SDS 0.4X2.5X75	9009030000

LSF-SMT 7.62/././135

Reflow-compatible PCB Terminal



Dimensioned drawing

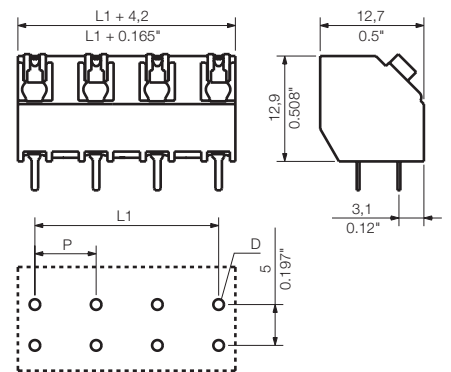

Ordering data

Solder pin length		1.5 mm	3.5 mm		
Colour		Black	Black		
Pitch 7.62 mm					
Pol.	L1	(inch)	Qty.	Order No.	Order No.
2	7.62	0.300	46	1884950000	1886180000
3	15.24	0.600	28	1884960000	1886190000
4	22.86	0.900	20	1884970000	1886200000
5	30.48	1.200	15	1884980000	1886210000
6	38.10	1.500	13	1884990000	1886220000
7	45.72	1.800	11	1885000000	1886230000
8	53.34	2.100	9	1885010000	1886240000

Representative deratings curve

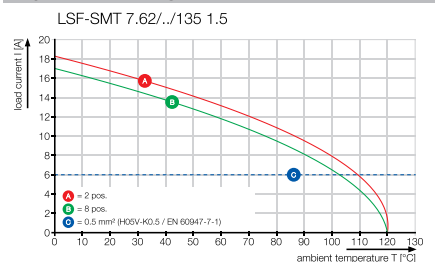

LSF-SMT 7.62/./135 Tape

Reflow-compatible PCB Terminal



Dimensioned drawing

Ordering data

Solder pin length		1.5 mm	3.5 mm		
Colour		Black	Black		
Pitch		7.62 mm			
Pol.	L1 (inch)	Qty.	Order No.		
2	7.62	0.300	190	1887110000	1887160000
3	15.24	0.600	190	1887120000	1887170000
4	22.86	0.900	190	1887130000	1887180000
5	30.48	1.200	190	1887140000	1887190000
6	38.10	1.500	190	1887150000	1887200000

Tape widths: 32, 44, 56, 72, 88

Additional deratings curves

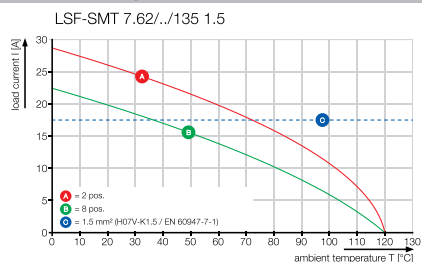

LSF-SMT 7.62/././180

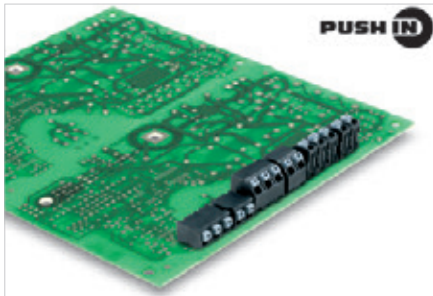

PCB terminal for fully automatic assembly, in 7.62 mm pitch, for THR reflow soldering (SMT) and wave soldering.

- PUSH IN wire connection, for wire cross-sections up to 1.5 mm².
- Form and dimensional stability provided by the LCP insulating material.
- Conductor inserted and slider operated in same direction (TOP).
- Packaged in tube or tape-on-reel.
- Pin lengths optimised to 1.5 mm or 3.5 mm.
- Wire outlet direction of 180°.

Technical data

In compliance with IEC 60664-1 / IEC 61984			
Clamping range, max.	mm ²	0.13...1.5	
Solid core H05(07) V-U	mm ²	0.2...1.5	
Stranded H07 V-R			
Flexible H05(07) V-K	mm ²	0.2...1.5	
Flexible with ferrule	mm ²	0.25...1.5	
Ferrule with plastic collar	mm ²	0.25...0.75	
Stripping length	mm	8	
Screwdriver blade	mm		
According to norm			
Tightening torque range	Nm		
Rated current, max.	A	17.5	17.5
At ambient temperature		20°C	40°C
For conductor cross-section	mm ²	1.5	
Overtoltage category		III	III II
Pollution severity		3	2 2
Rated voltage	V	500	630 800
Rated impulse voltage	kV	6	6 6
UL / CUL (Use Group)		B	C D
Rated voltage	V	300	150 300
Rated current	A	12	10 10
AWG conductor	AWG	24-16	
CSA (Use Group)		B	C D
Rated voltage	V	300	150 300
Rated current	A	10	10 10
AWG conductor	AWG	24-16	
General data			
Type of insulation material		LCP GF	
UL 94 flammability rating		V-0	
Contact base material		Copper alloy	
Material of contact surface		tinned	
Pin dimensions = d	mm	0.35 x 0.8	
Solder eyelet Ø = D	mm	1.1	
Solder eyelet Ø tolerance	mm	+ 0,1	

Product data

IEC: 800 V / 17.5 A / 0.2 - 1.5 mm²
 UL: 300 V / 12 A / AWG 24 - 16

For additional articles and information, refer to catalog.weidmueller.com

Note:

- Additional push button colours on request
- Rated current related to rated cross-section & min. No. of poles.
- Wire end ferrule without plastic collar to DIN 46228/1
- P on drawing = pitch
- Operating force of slider max. 40 N
- Rated data refer only to the component itself. Clearance and creepage distances to other components are to be designed in accordance with the relevant application standards.
- Crimping shape „A“ for wire end ferrules with PZ 6/5 crimping tool are recommended for the largest cable sizes.

LSF-SMT 7.62/././180

Reflow-compatible PCB Terminal

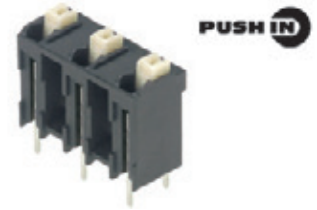

Dimensioned drawing

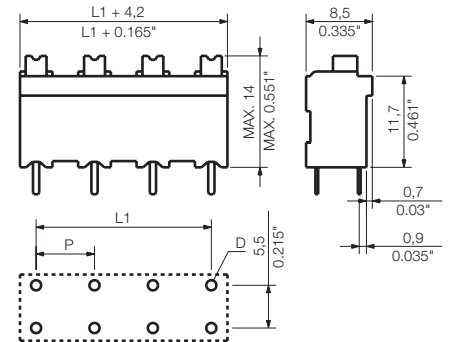

Accessories

Note: Refer to the Accessories chapter for additional accessories.

Screwdriver		Order No.
	SDIS 0.4X2.5X75	9008370000
	SDS 0.4X2.5X75	9009030000

Ordering data

Solder pin length		1.5 mm	3.5 mm		
Colour		Black	Black		
Pitch 7.62 mm					
Pol.	L1	(inch)	Qty.	Order No.	Order No.
2	7.62	0.300	46	1869810000	1826210000
3	15.24	0.600	28	1869830000	1826220000
4	22.86	0.900	20	1869840000	1826230000
5	30.48	1.200	15	1869850000	1826240000
6	38.10	1.500	13	1869860000	1826250000
7	45.72	1.800	11	1869870000	1826260000
8	53.34	2.100	9	1869880000	1826270000

Representative deratings curve

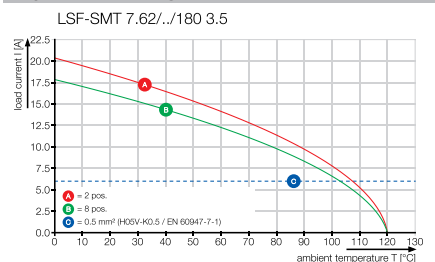

LSF-SMT 7.62/./180 Tape

Reflow-compatible PCB Terminal



Dimensioned drawing

Ordering data

Solder pin length		1.5 mm	3.5 mm		
Colour		Black	Black		
Pitch		7.62 mm			
Pol.	L1 (inch)	Qty.	Order No.		
2	7.62	0.300	175	1874870000	1874750000
3	15.24	0.600	175	1874650000	1874630000
4	22.86	0.900	175	1874530000	1874500000
5	30.48	1.200	175	1874450000	1874460000
6	38.10	1.500	175	1874390000	1874360000

Tape widths: 32, 44, 56, 72, 88

Additional deratings curves

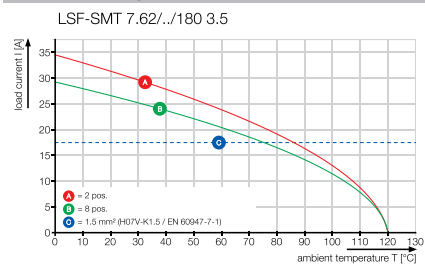

LMZF & LMZFL 5/..../135

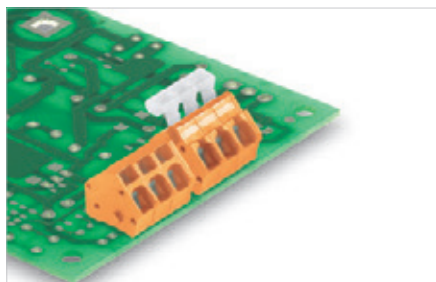

The compact installation terminal with tension-clamp wire connection, in 5.00 mm pitch for wire cross-sections up to 2.5 mm².

- Variable pitch 5.00-5.08 mm (1 component = 2 pitches).
- Wire outlet direction of 135°.
- Convenient: optional lever for simple opening of terminal point.

Technical data

In compliance with IEC 60664-1 / IEC 61984			
Clamping range, max.	mm ²	0.13...2.5	
Solid core H05(07) V-U	mm ²	0.13...2.5	
Stranded H07 V-R			
Flexible H05(07) V-K	mm ²	0.13...2.5	
Flexible with ferrule	mm ²	0.25...1.5	
Ferrule with plastic collar	mm ²	0.25...1.5	
Stripping length	mm	6	
Screwdriver blade	mm	0.4 x 2.5	
According to norm		DIN 5264-A	
Tightening torque range	Nm		
Rated current, max.	A	24	24
At ambient temperature		20°C	40°C
For conductor cross-section	mm ²	2.5	
Overtoltage category		III	III II
Pollution severity		3	2 2
Rated voltage	V	250	320 630
Rated impulse voltage	kV	4	4 4
UL / CUL (Use Group)	B C D	B	C D
Rated voltage	V	300	300
Rated current	A	15	10
AWG conductor	AWG	26-14	
CSA (Use Group)	B C D	B	C D
Rated voltage	V	300	300
Rated current	A	20	10
AWG conductor	AWG	26-14	
General data			
Type of insulation material		Wemid (PA)	
UL 94 flammability rating		V-0	
Contact base material		E-Cu	
Material of contact surface		tinned	
Pin dimensions = d	mm	0.8 x 0.8	
Solder eyelet Ø = D	mm	1.3	
Solder eyelet Ø tolerance	mm	+ 0,1	

Product data

IEC: 630 V / 24 A / 0.13 - 2.5 mm²
 UL: 300 V / 15 A / AWG 26 - 14

For additional articles and information, refer to catalog.weidmueller.com

Note:

- Rated current related to rated cross-section & min. No. of poles.
- Wire end ferrule without plastic collar to DIN 46228/1
- Wire end ferrule with plastic collar to DIN 46228/4
- P on drawing = pitch
- Rated data refer only to the component itself. Clearance and creepage distances to other components are to be designed in accordance with the relevant application standards.

LMZF 5/..../135



Dimensioned drawing

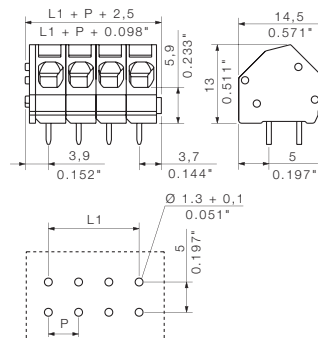

Accessories

Note: Refer to the Accessories chapter for additional accessories.

Screwdriver		Order No.
	SDIS 0.6X3.5X100	9008390000
	SDS 0.6X3.5X100	9008330000

Ordering data

Solder pin length		3.5 mm		
Colour		Orange		
Pitch		5.00 mm		
Pol.	L1	(inch)	Qty.	Order No.
2	5.00	0.197	100	1913780000
3	10.00	0.394	100	1913820000
4	15.00	0.591	100	1913960000
5	20.00	0.787	100	1914000000
6	25.00	0.984	100	1914020000
7	30.00	1.181	100	1914030000
8	35.00	1.378	100	1914040000
9	40.00	1.575	100	1914050000
10	45.00	1.772	100	1914070000
11	50.00	1.969	100	1914080000
12	55.00	2.165	100	1914090000
13	60.00	2.362	100	1960140000
14	65.00	2.559	100	1960150000
15	70.00	2.756	100	1960160000
16	75.00	2.953	100	1960170000
17	80.00	3.150	50	1960180000
18	85.00	3.346	50	1960190000
19	90.00	3.543	50	1960200000
20	95.00	3.740	50	1960210000
21	100.00	3.937	50	1960220000
22	105.00	4.134	50	1960230000
23	110.00	4.331	50	1960240000
24	115.00	4.528	50	1960250000

Representative deratings curve

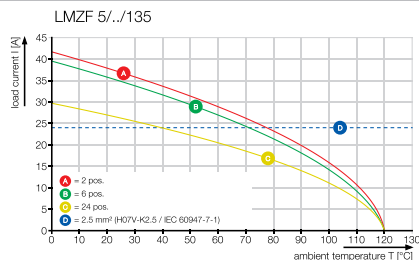

LMZFL 5/./135



Dimensioned drawing

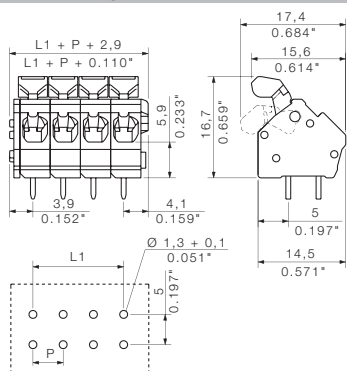

Ordering data

Solder pin length		3.5 mm		
Colour		Orange		
Pitch		5.00 mm		
Pol.	L1	(inch)	Qty.	Order No.
2	5.00	0.197	100	1914560000
3	10.00	0.394	100	1914580000
4	15.00	0.591	100	1914590000
5	20.00	0.787	100	1914600000
6	25.00	0.984	100	1914640000
7	30.00	1.181	100	1914720000
8	35.00	1.378	100	1914790000
9	40.00	1.575	100	1914830000
10	45.00	1.772	100	1914860000
11	50.00	1.969	100	1914990000
12	55.00	2.165	100	1915030000
13	60.00	2.362	50	1958320000
14	65.00	2.559	50	1958330000
15	70.00	2.756	50	1958350000
16	75.00	2.953	50	1958370000
17	80.00	3.150	50	1958390000
18	85.00	3.346	50	1958410000
19	90.00	3.543	50	1958440000
20	95.00	3.740	50	1958450000
21	100.00	3.937	50	1958470000
22	105.00	4.134	50	1958490000
23	110.00	4.331	50	1958500000
24	115.00	4.528	50	1958510000

Additional deratings curves

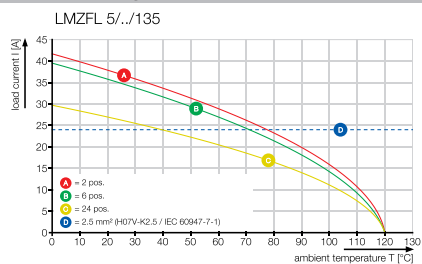

LMZF & LMZF 7../135

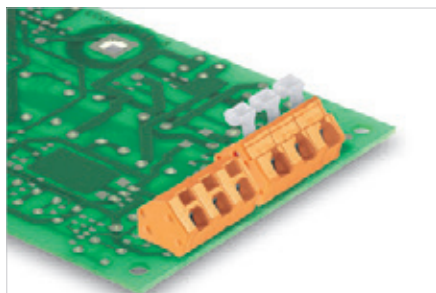

The compact installation terminal with tension-clamp wire connection, in 7.50 mm pitch for wire cross-sections up to 2.5 mm².

- Variable pitch 7.50-7.62 mm (1 component = 2 pitches).
- Wire outlet direction of 135°.
- Convenient: optional lever for simple opening of terminal point.

Technical data

In compliance with IEC 60664-1 / IEC 61984		
Clamping range, max.	mm ²	0.13...2.5
Solid core H05(07) V-U	mm ²	0.13...2.5
Stranded H07 V-R		
Flexible H05(07) V-K	mm ²	0.13...2.5
Flexible with ferrule	mm ²	0.25...1.5
Ferrule with plastic collar	mm ²	0.25...1.5
Stripping length	mm	6
Screwdriver blade	mm	0.6 x 3.5
According to norm		DIN 5264-A
Tightening torque range	Nm	
Rated current, max.	A	24 24
At ambient temperature		20°C 40°C
For conductor cross-section	mm ²	2.5
Overtoltage category		III III II
Pollution severity		3 2 2
Rated voltage	V	400 800 1000
Rated impulse voltage	kV	6 6 6
UL / CUL (Use Group)	B C D	
Rated voltage	V	300 150 300
Rated current	A	15 15 10
AWG conductor	AWG	26-14
CSA (Use Group)	B C D	
Rated voltage	V	300 150 300
Rated current	A	15 15 10
AWG conductor	AWG	26-14
General data		
Type of insulation material		Wemid (PA)
UL 94 flammability rating		V-0
Contact base material		E-Cu
Material of contact surface		tinned
Pin dimensions = d	mm	0.8 x 0.8
Solder eyelet Ø = D	mm	1.3
Solder eyelet Ø tolerance	mm	+ 0,1

Product data

IEC: 1000 V / 24 A / 0.13 - 2.5 mm²
 UL: 300 V / 15 A / AWG 26 - 14

For additional articles and information, refer to catalog.weidmueller.com

Note:

- Rated current related to rated cross-section & min. No. of poles.
- Wire end ferrule without plastic collar to DIN 46228/1
- Wire end ferrule with plastic collar to DIN 46228/4
- P on drawing = pitch
- Rated data refer only to the component itself. Clearance and creepage distances to other components are to be designed in accordance with the relevant application standards.

LMZF 7../135



Dimensioned drawing

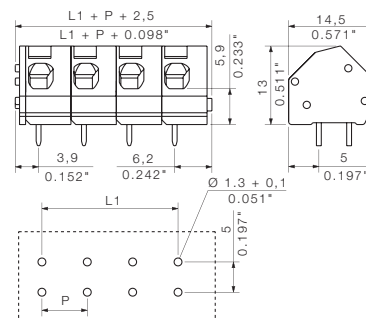

Accessories

Note: Refer to the Accessories chapter for additional accessories.

Screwdriver	Order No.
SDIS 0.6X3.5X100	9008390000
SDS 0.6X3.5X100	9008330000



Ordering data

Solder pin length		3.5 mm		
Colour		Orange		
Pitch		7.50 mm		
Pol.	L1	(inch)	Qty.	Order No.
2	7.50	0.295	100	1952570000
3	15.00	0.591	100	1952580000
4	22.50	0.886	100	1952590000
5	30.00	1.181	100	1952600000
6	37.50	1.476	100	1952610000
7	45.00	1.772	100	1952620000
8	52.50	2.067	100	1952630000
9	60.00	2.362	100	1952640000
10	67.50	2.657	100	1952650000
11	75.00	2.953	100	1952660000
12	82.50	3.248	100	1952670000

Representative deratings curve

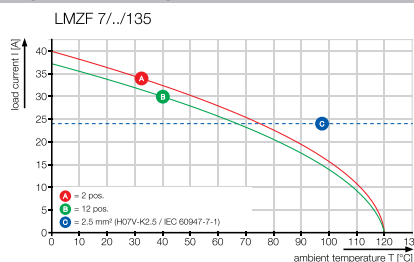

LMZFL 7../135



Dimensioned drawing

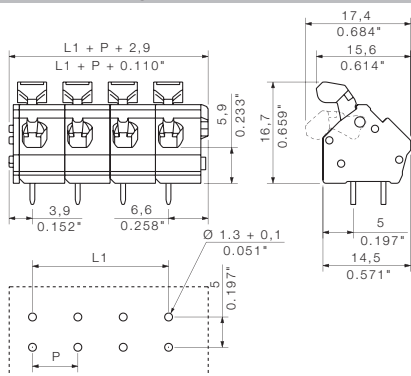

Ordering data

Solder pin length		3.5 mm	
Colour		Orange	
Pitch		7.50 mm	
Pol.	L1	(inch)	Qty. Order No.
2	7.50	0.295	100 1953010000
3	15.00	0.591	100 1953020000
4	22.50	0.886	100 1953030000
5	30.00	1.181	100 1953040000
6	37.50	1.476	100 1953050000
7	45.00	1.772	100 1953060000
8	52.50	2.067	100 1953070000
9	60.00	2.362	100 1953080000
10	67.50	2.657	100 1953090000
11	75.00	2.953	100 1953100000
12	82.50	3.248	100 1953110000

Additional deratings curves

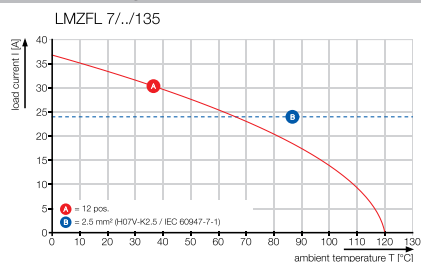

LMZF & LMZF 10../135

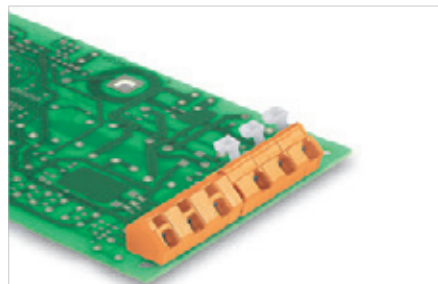

The compact installation terminal with tension-clamp wire connection, in 10.00 mm pitch for wire cross-sections up to 2.5 mm².

- Variable pitch 10.00-10.16 mm (1 component = 2 pitches).
- Wire outlet direction of 135°.
- Convenient: optional lever for simple opening of terminal point.

Technical data

In compliance with IEC 60664-1 / IEC 61984			
Clamping range, max.	mm ²	0.13...2.5	
Solid core H05(07) V-U	mm ²	0.13...2.5	
Stranded H07 V-R			
Flexible H05(07) V-K	mm ²	0.13...2.5	
Flexible with ferrule	mm ²	0.25...1.5	
Ferrule with plastic collar	mm ²	0.25...1.5	
Stripping length	mm	6	
Screwdriver blade	mm	0.6 x 3.5	
According to norm		DIN 5264	
Tightening torque range	Nm		
Rated current, max.	A	24	24
At ambient temperature		20°C	40°C
For conductor cross-section	mm ²	2.5	
Overtoltage category		III	III II
Pollution severity		3	2 2
Rated voltage	V	500	1000 1000
Rated impulse voltage	kV	8	8 8
UL / CUL (Use Group)		B	C D
Rated voltage	V	300	150 300
Rated current	A	15	15 10
AWG conductor	AWG	26-14	
CSA (Use Group)		B	C D
Rated voltage	V	300	150 300
Rated current	A	15	15 10
AWG conductor	AWG	26-14	
General data			
Type of insulation material		Wemid (PA)	
UL 94 flammability rating		V-0	
Contact base material		E-Cu	
Material of contact surface		tinned	
Pin dimensions = d	mm	0.8 x 0.8	
Solder eyelet Ø = D	mm	1.3	
Solder eyelet Ø tolerance	mm	+ 0,1	

Product data

IEC: 1000 V / 24 A / 0.13 - 2.5 mm²
 UL: 300 V / 15 A / AWG 26 - 14

For additional articles and information, refer to catalog.weidmueller.com

Note:

- Rated current related to rated cross-section & min. No. of poles.
- Wire end ferrule without plastic collar to DIN 46228/1
- Wire end ferrule with plastic collar to DIN 46228/4
- P on drawing = pitch
- Rated data refer only to the component itself. Clearance and creepage distances to other components are to be designed in accordance with the relevant application standards.

LMZF 10../135



Dimensioned drawing

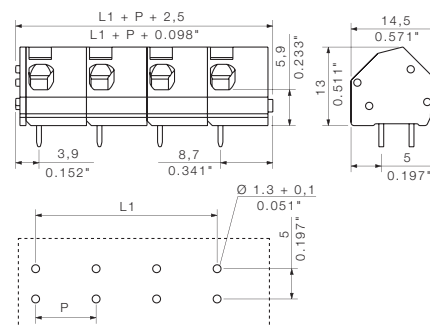

Ordering data

Solder pin length		3.5 mm		
Colour		Orange		
Pitch		10.00 mm		
Pol.	L1	(inch)	Qty.	Order No.
2	10.00	0.394	100	1953470000
3	20.00	0.787	100	1953480000
4	30.00	1.181	100	1953490000
5	40.00	1.575	100	1953500000
6	50.00	1.969	100	1953510000
7	60.00	2.362	100	1953520000
8	70.00	2.756	100	1953530000
9	80.00	3.150	100	1953540000
10	90.00	3.543	100	1953550000
11	100.00	3.937	100	1953560000
12	110.00	4.331	100	1953570000

Accessories

Note: Refer to the Accessories chapter for additional accessories.

Screwdriver	Order No.
SDIS 0.6X3.5X100	9008390000
SDS 0.6X3.5X100	9008330000

Representative deratings curve

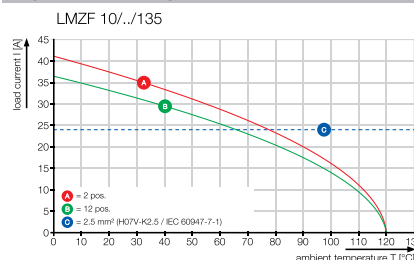

LMZFL 10../135



Dimensioned drawing

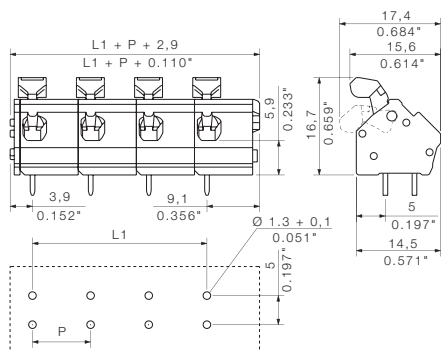

Ordering data

Solder pin length		3.5 mm		
Colour		Orange		
Pitch		10.00 mm		
Pol.	L1	(inch)	Qty.	Order No.
2	10.00	0.394	100	1953930000
3	20.00	0.787	100	1953940000
4	30.00	1.181	100	1953950000
5	40.00	1.575	100	1953960000
6	50.00	1.969	100	1953970000
7	60.00	2.362	100	1953980000
8	70.00	2.756	100	1953990000
9	80.00	3.150	100	1954000000
10	90.00	3.543	100	1954010000
11	100.00	3.937	100	1954020000
12	110.00	4.331	100	1954030000

Additional deratings curves

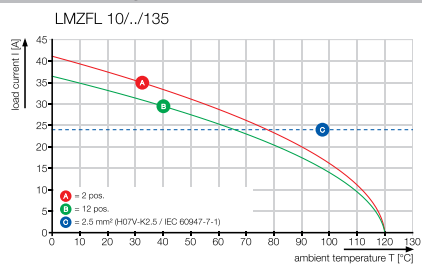

LMZF 5.08, multi level

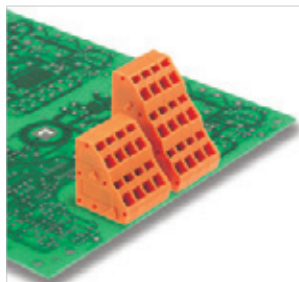

The high-performance device interface with a high connection density. Multi-level PCB terminal with clamping-yoke screw connection in 5.08 mm pitch, suitable for wire cross-sections up to 2.5 mm².

- Wire outlet direction of 135°.
- Simple change of connection method - layout is compatible with multi-level screw terminals.

Technical data

In compliance with IEC 60664-1 / IEC 61984		
Clamping range, max.	mm ²	0.13...2.5
Solid core H05(07) V-U	mm ²	0.2...2.5
Stranded H07 V-R		
Flexible H05(07) V-K	mm ²	0.2...1.5
Flexible with ferrule	mm ²	0.25...1.5
Ferrule with plastic collar	mm ²	0.25...1.5
Stripping length	mm	7.5
Screwdriver blade	mm	0.6 x 3.5
According to norm		DIN 5264-A
Tightening torque range	Nm	
Rated current, max.	A	15 13
At ambient temperature	20°C	40°C
For conductor cross-section	mm ²	2.5
Overtoltage category		III III II
Pollution severity		3 2 2
Rated voltage	V	250 320 630
Rated impulse voltage	kV	4 4 4
UL / CUL (Use Group)	B C D	B C D
Rated voltage	V	300 300
Rated current	A	10 10
AWG conductor	AWG	24-14
CSA (Use Group)	B C D	B C D
Rated voltage	V	300 300
Rated current	A	10 10
AWG conductor	AWG	24-14
General data		
Type of insulation material		PA
UL 94 flammability rating		V-2
Contact base material		Copper alloy
Material of contact surface		tinned
Pin dimensions = d	mm	0.8 x 1.0
Solder eyelet Ø = D	mm	1.3
Solder eyelet Ø tolerance	mm	+ 0,1

Product data

IEC: 630 V / 15 A / 0.2 - 2.5 mm²
 UL: 300 V / 10 A / AWG 24 - 14

For additional articles and information, refer to catalog.weidmuller.com

Note:

- Rated current related to rated cross-section & min. No. of poles.
- Wire end ferrule without plastic collar to DIN 46228/1
- Wire end ferrule with plastic collar to DIN 46228/4
- P on drawing = pitch
- Rated data refer only to the component itself. Clearance and creepage distances to other components are to be designed in accordance with the relevant application standards.

LM2NZF 5.08../135



Dimensioned drawing

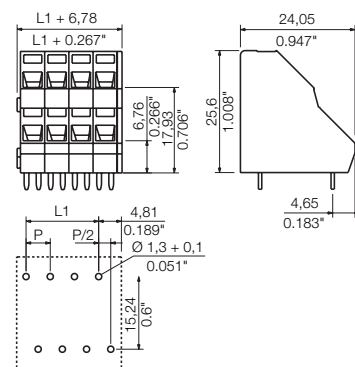

Ordering data

Solder pin length		3.5 mm		
Colour		Orange		
Pitch		5.08 mm		
Pol.	L1	(inch)	Qty.	Order No.
4	5.08	0.200	50	1764810000
6	10.16	0.400	50	1764820000
8	15.24	0.600	50	1764830000
10	20.32	0.800	50	1764840000
12	25.40	1.000	50	1764850000
14	30.48	1.200	20	1764860000
16	35.56	1.400	20	1764870000
18	40.64	1.600	20	1764880000
20	45.72	1.800	20	1758020000
22	50.80	2.000	20	1764890000
24	55.88	2.200	10	1764900000
26	60.96	2.400	10	1782500000
28	66.04	2.600	10	1782510000
30	71.12	2.800	10	1782520000
32	76.20	3.000	10	1782530000
34	81.28	3.200	10	1782540000
36	86.36	3.400	10	1782550000

Representative deratings curve

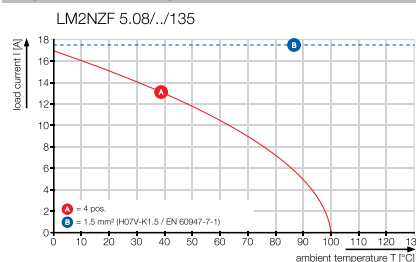

LM3RZF 5.08/./135



Dimensioned drawing

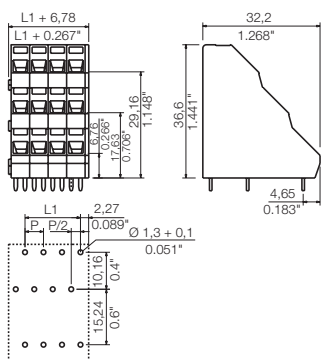

Ordering data

Solder pin length		3.5 mm		
Colour		Orange		
Pitch		5.08 mm		
Pol.	L1	(inch)	Qty.	Order No.
6	5.08	0.200	50	1764910000
9	10.16	0.400	50	1764920000
12	15.24	0.600	50	1764930000
15	20.32	0.800	20	1764940000
18	25.40	1.000	20	1764950000
21	30.48	1.200	20	1758040000
24	35.56	1.400	10	1764960000
27	40.64	1.600	10	1764970000
30	45.72	1.800	10	1758030000
33	50.80	2.000	10	1764980000
36	55.88	2.200	10	1764990000
48	76.20	3.000	10	1758050000

Additional deratings curves

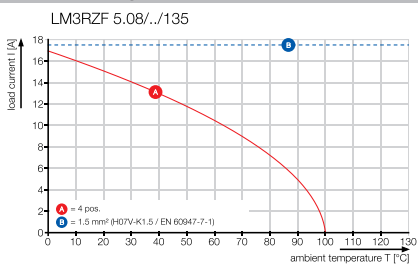

OMNIMATE Signal PCB connectors

OMNIMATE Signal PCB connectors

Double-row connectors in 3.50 mm pitch
Series B2C/S2C 3.50

Explanation	C.2
Quick selection	C.4
Technical data	C.6

Connectors in 3.50 mm pitch
Series BL/SL 3.50

Explanation	C.20
Quick selection	C.24
Technical data	C.26

Connectors in 3.81 mm pitch
Series BC/SC 3.81

Explanation	C.60
Quick selection	C.64
Technical data	C.66

Connectors in 5.00 mm and 5.08 mm pitch
Series BL/SL 5.00

Explanation	C.120
Quick selection	C.132
Technical data	C.134

Connectors in 5.00 mm and 5.08 mm pitch
Series BL/SL 5.08

Explanation	C.120
Quick selection	C.162
Technical data	C.168

Connectors in 5.00 mm pitch
Series RSV

Explanation	C.250
Quick selection	C.252
Technical data	C.256



Powerful compact connector with PUSH IN wire connection

OMNIMATE Signal – simple and safe connection for wires up to 1.5 mm²

When designing customised device connectivity products for modern applications, it is becoming increasingly important to find the perfect fit between device miniaturisation and increased device functionality. Our new double-row OMNIMATE B2CF Signal connector, in 3.5 mm pitch, has this perfect fit and enables a new generation of more compact installations.

This connector is easy to work with, despite the increased functionality being packed into a compact space. The PUSH IN direct-insert wire connection mechanism allows you to conveniently connect the signal wires. There are more useful features: the tool-free locking and unlocking, the touch-safe male header, and the outstanding clarity provided by easy-to-read markers that identify each terminal point.

Packing Density 2.0

Smaller devices with increased technical capabilities are being designed for more applications. They take advantage of more contacts packed onto a small surface and a large wire cross-section capacity.

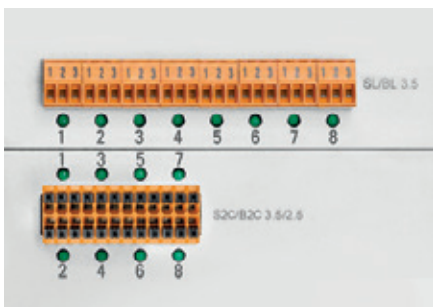

Clear frontal marking

Clarity is enhanced with clearly legible markers at each terminal point and unique labelling of the installation position.



Large wire cross-sections

You can easily connect wires with cross-sections up to 1.5 mm² (when using wire-end ferrules) and up to 1.0 mm² (when using ferrules and plastic collars).

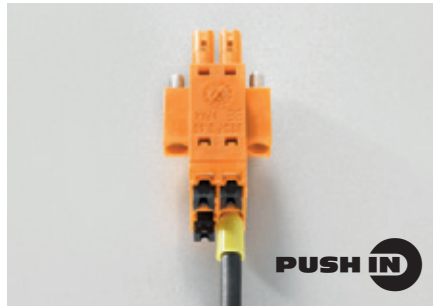

Direct insertion

PUSH IN: the quick, tool-free, intuitive connection mechanism for prepared wires. www.push-in.com

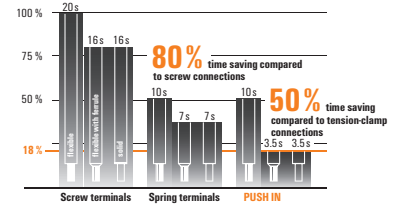

Halogen-free and IEC 60335

Halogen-free materials ensure future compatibility and extended approvals enhance the range of use for new device designs.



Convincing system accessories

Our matching accessories – including markers, light guides, strain relief and coding – improve operational safety and enable a professional design.



Convincing safety during use

This connector system is safe to use, with attractive features such as quick wire connections, tool-free locking and unlocking, and touch-safe design.

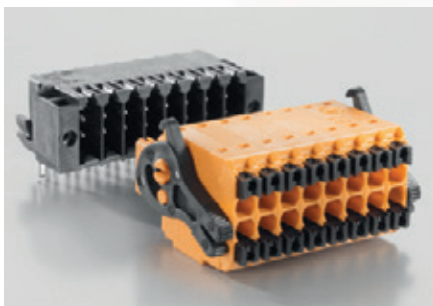





Solid PUSH IN contacts

A safe, permanent connection is ensured by the optimised spring steel and specially-shaped contact element.



<http://www.OMNIMATE.net>

-  = Wire-to-Board
-  = Board-to-Board
-  = Wire-to-Wire
-  = Board-to-Wire

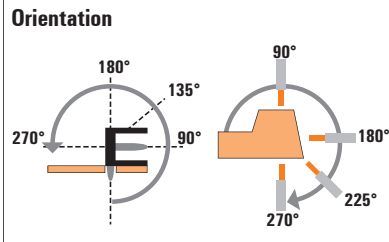



C

B2C/S2C 3.50 series



Type		Orientation		Flange options		IEC / UL		Levels
								Page

Female header		Tension clamp		B2CF		180°		(G)/F/LR		IEC: 320 V/13,4 A/0,14 - 1,5 mm ² UL: 300 V/10 A/AWG 26 - 16		C.12	
													
Female header		Tension clamp (with internal cross connection)		B2L QV		180°		(G)/F/LH		IEC: 200 V/10.6 A/0.2 - 1 mm ² UL: 150 V/7 A/AWG 28 - 18		C.18	
													

Female connector:
(G)* = Closed (without flange)
F = Screw flange with screw
LH = Release lever
LR = Lock & Release lever

Male header:
G = Closed (without flange)
F = Screw flange with nut
LF = Solder flange with nut

* not included in the article description

Male header



Reflow solder connection



Solder connection



1		2		1	
S2C-SMT	S2C-SMT	S2CD-THR	S2L	S2L	
90°	180°	90°	90°	180°	
G/LF	G/LF	G/LF	G/F	G/F	
IEC: 200 V/13,4 A UL: 150 V/10 A	IEC: 200 V/13,4 A UL: 150 V/10 A	IEC: 200 V/7,9 A UL: 150 V/7 A	IEC: 250 V/10 A UL: 150 V/10 A	IEC: 250 V/10 A UL: 150 V/10 A	
C.6	C.8	C.10	C.14	C.16	
○	○	○	○	○	
			○	○	

Double-row connectors in 3.50 mm pitch Series B2C/S2C 3.50

B2CF/S2C and B2L/S2C 3.50 series

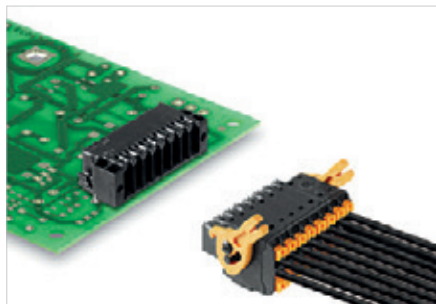

High-temperature-resistant, double-row male header

- Finger-safe
- Plugging direction parallel to PCB (recumbent / 90°)
- Housing variants: closed (G) and with solder flange (LF)
- Packed either in a box (BX) or tape-on-reel (RL)
- Suitable for reflow and wave soldering applications
- Pin length of either 1.5 mm or 3.2 mm
- Can be plugged into female plug B2CF 3.50/./180..

Technical data

In compliance with IEC 60664-1 / IEC 61984			
Clamping range, max.	mm ²		
Solid core H05(07) V-U	mm²		
Stranded H07 V-R			
Flexible H05(07) V-K	mm ²		
Flexible with ferrule	mm ²		
Ferrule with plastic collar	mm ²		
Stripping length	mm		
Screwdriver blade	mm		
According to norm			
Tightening torque range	Nm		
Rated current, max.	A	13.4	12
At ambient temperature		20°C	40°C
For conductor cross-section	mm ²		
Overtolerance category		III	III II
Pollution severity		3	2 2
Rated voltage	V	80	160 200
Rated impulse voltage	kV	2.5	2.5 2.5
UL / CUL (Use Group)		B	C D
Rated voltage	V	150	50
Rated current	A	10	10
AWG conductor	AWG		-
CSA (Use Group)		B	C D
Rated voltage	V	150	
Rated current	A	10	
AWG conductor	AWG		-
General data			
Type of insulation material		LCP GF	
UL 94 flammability rating		V-0	
Contact base material		Copper alloy	
Material of contact surface		tinned	
Pin dimensions = d	mm	1.0, Octagonal	
Solder eyelet Ø = D	mm	1.3	
Solder eyelet Ø tolerance	mm	+ 0,1	

Product data

IEC: 200 V / 13.4 A

UL: 150 V / 10 A

For additional articles and information, refer to catalog.weidmueller.com

Note:

- Gold-plated contact surfaces on request
- Rated current related to rated cross-section & min. No. of poles.
- Spacing between rows: see hole layout
- P on drawing = pitch
- Rated data refer only to the component itself. Clearance and creepage distances to other components are to be designed in accordance with the relevant application standards.

S2C-SMT 3.50/./90G Box

closed side



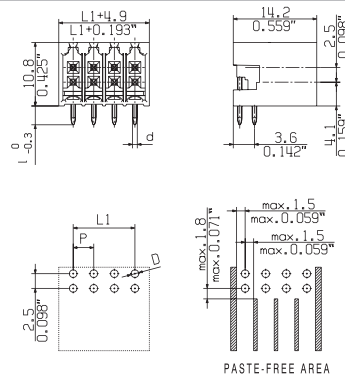

Dimensioned drawing



Accessories

Note: Refer to the Accessories chapter for additional accessories.

Coding		Order No.
	B2L/S2L 3.5 KO OR	1849730000
	B2L/S2L 3.5 KO SW	1849740000
LED light guide		
	S2L-SMT 3.5 FLA 20/10	1814590000

Ordering data

Solder pin length	1.5 mm		3.2 mm		
	Black		Black		
Pitch	3.50 mm				
Pol.	L1	(inch)	Qty.	Order No.	Order No.
4	3.50	0.138	222	1289630000	1288980000
6	7.00	0.276	156	1289640000	1289270000
8	10.50	0.413	120	1289650000	1289280000
10	14.00	0.551	96	1289670000	1289290000
12	17.50	0.689	84	1289680000	1289300000
14	21.00	0.827	72	1289700000	1289310000
16	24.50	0.965	60	1289710000	1289320000
18	28.00	1.102	54	1289720000	1289330000
20	31.50	1.240	48	1289730000	1289340000
22	35.00	1.378	42	1289740000	1289350000
24	38.50	1.516	42	1289750000	1289370000
26	42.00	1.654	36	1289770000	1289380000
28	45.50	1.791	36	1289780000	1289390000
30	49.00	1.929	30	1289790000	1289410000
32	52.50	2.067	30	1289800000	1289420000
34	56.00	2.205	30	1289810000	1289430000
36	59.50	2.343	24	1289820000	1289440000

S2C-SMT 3.50/./90G Tape

closed side; tape-on-reel



Dimensioned drawing

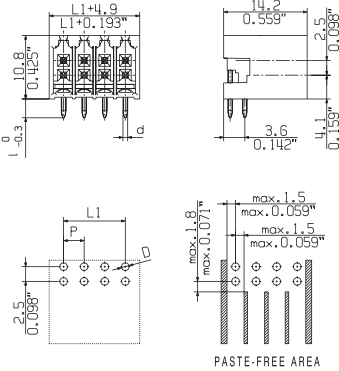

Ordering data

Solder pin length		1.5 mm	3.2 mm
Colour		Black	Black
Pitch	3.50 mm		
Pol.	L1 (inch)	Qty.	Order No.
4	3.50	0.138	235 1359580000 1359460000
6	7.00	0.276	235 1359590000 1359470000
8	10.50	0.413	235 1359600000 1359480000
10	14.00	0.551	235 1359610000 1359490000
12	17.50	0.689	235 1359620000 1359510000
14	21.00	0.827	235 1359630000 1359520000
16	24.50	0.965	235 1359640000 1359530000
18	28.00	1.102	235 1359650000 1359540000
20	31.50	1.240	235 1359670000 1359550000
22	35.00	1.378	235 1359680000 1359560000
24	38.50	1.516	235 1359690000 1359570000

Tape widths: 32, 44, 56, 72, 88

S2C-SMT 3.50/./90LF Box

with solder flange



Dimensioned drawing

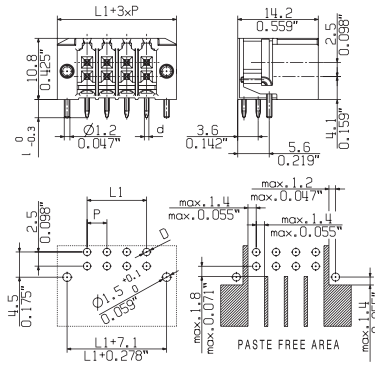

Ordering data

Solder pin length		1.5 mm	3.2 mm
Colour		Black	Black
Pitch	3.50 mm		
Pol.	L1 (inch)	Qty.	Order No.
4	3.50	0.138	132 1289830000 1289450000
6	7.00	0.276	102 1289840000 1289460000
8	10.50	0.413	84 1289850000 1289470000
10	14.00	0.551	72 1289870000 1289480000
12	17.50	0.689	66 1289880000 1289490000
14	21.00	0.827	54 1289890000 1289500000
16	24.50	0.965	48 1289910000 1289510000
18	28.00	1.102	48 1289930000 1289520000
20	31.50	1.240	42 1289940000 1289530000
22	35.00	1.378	36 1289950000 1289540000
24	38.50	1.516	36 1289960000 1289550000
26	42.00	1.654	30 1289970000 1289570000
28	45.50	1.791	30 1289980000 1289580000
30	49.00	1.929	30 1289990000 1289590000
32	52.50	2.067	24 1290000000 1289600000
34	56.00	2.205	24 1290010000 1289610000
36	59.50	2.343	24 1290020000 1289620000

S2C-SMT 3.50/./90LF Tape

with solder flange; tape-on-reel



Dimensioned drawing

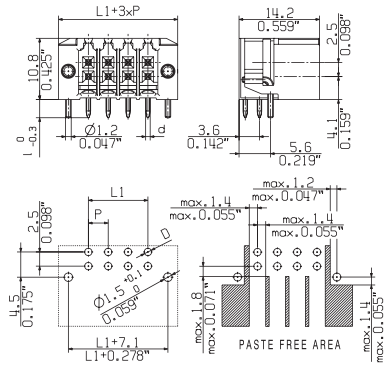

Ordering data

Solder pin length		1.5 mm	3.2 mm
Colour		Black	Black
Pitch	3.50 mm		
Pol.	L1 (inch)	Qty.	Order No.
4	3.50	0.138	235 1359080000 1358890000
6	7.00	0.276	235 1359090000 1358910000
8	10.50	0.413	235 1359110000 1358930000
10	14.00	0.551	235 1359120000 1358950000
12	17.50	0.689	235 1359130000 1358980000
14	21.00	0.827	235 1359140000 1359010000
16	24.50	0.965	235 1359150000 1359030000
18	28.00	1.102	235 1359160000 1359050000
20	31.50	1.240	235 1359170000 1359070000

Tape widths: 32, 44, 56, 72, 88

Double-row connectors in 3.50 mm pitch Series B2C/S2C 3.50

S2CD-THR 3.50/./90

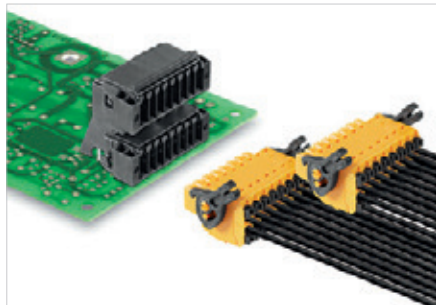

High contact density on small area: 75 % less space required on the PCB. The only 4-row double-level male header for typical IP 20 sensor interfaces in 3.50 mm pitch.

- Finger-safe
- Plugging direction parallel to PCB (recumbent/ 90°)
- Housing variants: closed (G) and with solder flange (LF)
- Packaged in a box (BX)
- Suitable for reflow and wave soldering applications
- Pin length 3.2 mm
- Can be plugged into female plug B2CF 3.50/./180..

Technical data

In compliance with IEC 60664-1 / IEC 61984			
Clamping range, max.	mm ²		
Solid core H05(07) V-U	mm²		
Stranded H07 V-R			
Flexible H05(07) V-K	mm ²		
Flexible with ferrule	mm ²		
Ferrule with plastic collar	mm ²		
Stripping length	mm		
Screwdriver blade	mm		
According to norm			
Tightening torque range	Nm		
Rated current, max.	A	7.9	6.8
At ambient temperature		20°C	40°C
For conductor cross-section	mm ²		
Overtoltage category		III	III II
Pollution severity		3	2 2
Rated voltage	V	100	160 200
Rated impulse voltage	kV	1.5	2.5 2.5
UL / CUL (Use Group)	B C D	B	C D
Rated voltage	V	150	
Rated current	A	7	
AWG conductor	AWG		
CSA (Use Group)	B C D	B	C D
Rated voltage	V	50	
Rated current	A	5	
AWG conductor	AWG		
General data			
Type of insulation material		LCP GF	
UL 94 flammability rating		V-0	
Contact base material		Copper alloy	
Material of contact surface		tinned	
Pin dimensions = d	mm	1.0, Octagonal	
Solder eyelet Ø = D	mm	1.3	
Solder eyelet Ø tolerance	mm	+ 0,1	

Product data

IEC: 200 V / 7.9 A

UL: 150 V / 7 A

For additional articles and information, refer to catalog.weidmueller.com

Note:

- Gold-plated contact surfaces on request
- Rated current related to rated cross-section & min. No. of poles.
- Spacing between rows: see hole layout
- P on drawing = pitch
- Rated data refer only to the component itself. Clearance and creepage distances to other components are to be designed in accordance with the relevant application standards.

S2CD-THR 3.50/./90G

closed side



Dimensioned drawing

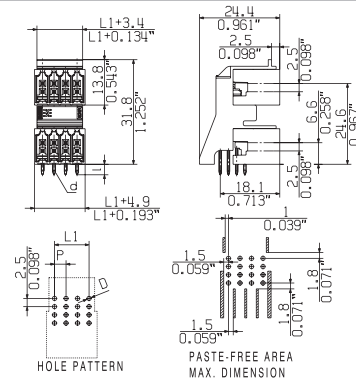

Accessories

Note: Refer to the Accessories chapter for additional accessories.

Coding	Order No.
B2L/S2L 3.5 KO OR	1849730000
B2L/S2L 3.5 KO SW	1849740000

Ordering data

Solder pin length		3.2 mm	
Colour		Black	
Pitch	3.50 mm		
Pol.	L1	(inch)	Qty. Order No.
8	3.50	0.138	50 1357790000
12	7.00	0.276	50 1357800000
16	10.50	0.413	20 1357820000
20	14.00	0.551	20 1357830000
24	17.50	0.689	20 1357840000
28	21.00	0.827	20 1357850000
32	24.50	0.965	20 1357870000
36	28.00	1.102	20 1357880000

1.5 mm solder pin length available on request

Double-row connectors in 3.50 mm pitch Series B2C/S2C 3.50

B2CF 3.50/./180



Two-row female plug with PUSH IN spring connection.

- Simply insert the prepared wires - finished
- Intuitive handling - since the wire-entry area and handling area are clearly separated.
- Integrated push-buttons for opening the terminal point
- High component density because of low heights
- Optional: the lock and release requires no tools when using Weidmüller's patented (LR) release latch
- Approval according to IEC 60335 and GL in preparation
- Also compatible with series: S2L 3.50, S2L-SMT 3.50 and S2LD-THR 3.50

Technical data

In compliance with IEC 60664-1 / IEC 61984

Clamping range, max.	mm ²	0.14...1.5
Solid core H05(07) V-U	mm²	0.14...1.5
Stranded H07 V-R		
Flexible H05(07) V-K	mm ²	0.14...1.5
Flexible with ferrule	mm ²	0.14...1.5
Ferrule with plastic collar	mm ²	0.14...1
Stripping length	mm	10
Screwdriver blade	mm	
According to norm		
Tightening torque range	Nm	
Rated current, max.	A	13.4 12
At ambient temperature	20°C	40°C
For conductor cross-section	mm ²	1.5
Overvoltage category		III III II
Pollution severity		3 2 2
Rated voltage	V	160 160 320
Rated impulse voltage	kV	2.5 2.5 2.5
UL / CUL (Use Group)		B C D
Rated voltage	V	300 50 300
Rated current	A	10 10 10
AWG conductor	AWG	26-16
CSA (Use Group)		B C D
Rated voltage	V	300
Rated current	A	5
AWG conductor	AWG	26-16
General data		
Type of insulation material		PA 66 GF 30
UL 94 flammability rating		V-0
Contact base material		Copper alloy
Material of contact surface		tinned
Pin dimensions = d	mm	
Solder eyelet Ø = D	mm	
Solder eyelet Ø tolerance	mm	

Product data

IEC: 320 V / 13.4 A / 0.14 - 1.5 mm²
UL: 300 V / 10 A / AWG 26 - 16

For additional articles and information, refer to catalog.weidmuller.com

Note:

- Additional colours on request
 - Gold-plated contact surfaces on request
 - Rated current related to rated cross-section & min. No. of poles.
 - Crimp shape A for wire-end ferrules with crimping tools PZ 1,5 (order no. 9005990000) or PZ 6/5 (order no. 9011460000) for larger wire cross-sections recommended.
 - P on drawing = pitch
 - Rated data refer only to the component itself. Clearance and creepage distances to other components are to be designed in accordance with the relevant application standards.
 - Max. outer diameter of the conductor 2.6 mm
- Wire-end ferrule w/plastic collar DIN 46228/4 or Weidmüller colour code
- 1.00mm² [H1.0/18D] mtl. ferrule leng. 12mm, stripping leng. 15mm
 - 0.75mm² [H0.75/18D] mtl. ferrule leng. 12mm, stripping leng. 14mm
 - 0.50mm² [H0.5/16D] mtl. ferrule leng. 10mm, stripping leng. 12mm
 - 0.34mm² [H0.34/12] mtl. ferrule leng. 8mm, stripping leng. 10mm
 - 0.25mm² [H0.25/12] mtl. ferrule leng. 8mm, stripping leng. 10mm
 - 0.14mm² [H0.14/12] mtl. ferrule leng. 8mm, stripping leng. 10mm
- Wire-end ferrule w/o plastic collar acc. to DIN 46228/1
- 1.50mm² [H1.5/10] mtl. ferrule leng. 10mm, stripping length 10mm
- Wire-end ferrule w/plastic collar DIN 46228/4 and 2 connec. cables
- 2 x 0.20mm² [H0.5/16] mtl. ferrule leng. 10mm, stripping leng. 12mm
 - 2 x 0.34mm² [H1.0/18] mtl. ferrule leng. 12mm, stripping leng. 15mm

Accessories

Note: Refer to the Accessories chapter for additional accessories.

Coding	Order No.
B2L/S2L 3.5 KO OR	1849730000
B2L/S2L 3.5 KO SW	1849740000
Strain relief	
BL 3.5 ZE 3 OR	1629680000
BL 3.5 ZE 3 SW	1627820000
BL 3.5 ZE 8 OR	1629690000
BL 3.5 ZE 8 SW	1627830000
Screwdriver	
SDS 0.4X2.5X75	9009030000
Crimping tool	
PZ 1.5	9005990000
PZ 6/5	9011460000

B2CF 3.50/./180



Dimensioned drawing

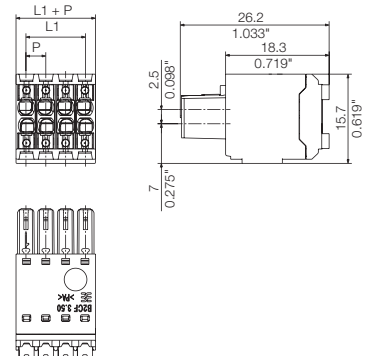

Ordering data

Solder pin length						
Colour	Orange		Black			
Pitch 3.50 mm						
Pol.	L1	(inch)	Qty.	Order No.	Order No.	
4	3.50	0.138	264	1277270000	1277460000	
6	7.00	0.276	174	1277280000	1277470000	
8	10.50	0.413	132	1277290000	1277480000	
10	14.00	0.551	102	1277310000	1277490000	
12	17.50	0.689	84	1277320000	1277510000	
14	21.00	0.827	72	1277330000	1277520000	
16	24.50	0.965	66	1277340000	1277530000	
18	28.00	1.102	54	1277350000	1277540000	
20	31.50	1.240	48	1277360000	1277550000	
22	35.00	1.378	48	1277370000	1277560000	
24	38.50	1.516	42	1277380000	1277570000	
26	42.00	1.654	36	1277390000	1277580000	
28	45.50	1.791	36	1277410000	1277590000	
30	49.00	1.929	30	1277420000	1277610000	
32	52.50	2.067	30	1277430000	1277620000	
34	56.00	2.205	30	1277440000	1277630000	
36	59.50	2.343	24	1277450000	1277640000	

B2CF 3.50/./180 - S2C-SMT 3.50/./190

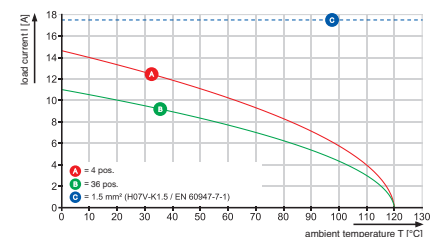

B2CF 3.50../180F

with screw flange



Dimensioned drawing

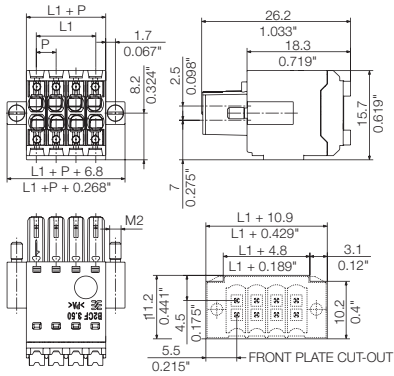

Ordering data

Solder pin length					
Colour	Orange	Black			
Pitch	3.50 mm				
Pol.	L1 (inch)	Qty.	Order No.	Order No.	
4	3.50	0.138	132	1277650000	1277860000
6	7.00	0.276	108	1277670000	1277870000
8	10.50	0.413	90	1277680000	1277880000
10	14.00	0.551	72	1277690000	1277890000
12	17.50	0.689	66	1277720000	1277900000
14	21.00	0.827	60	1277730000	1277910000
16	24.50	0.965	48	1277740000	1277920000
18	28.00	1.102	48	1277750000	1277930000
20	31.50	1.240	42	1277760000	1277940000
22	35.00	1.378	36	1277770000	1277950000
24	38.50	1.516	36	1277780000	1277970000
26	42.00	1.654	30	1277790000	1277980000
28	45.50	1.791	30	1277810000	1277990000
30	49.00	1.929	30	1277820000	1280000000
32	52.50	2.067	24	1277830000	1278010000
34	56.00	2.205	24	1277840000	1278020000
36	59.50	2.343	24	1277850000	1278030000

B2CF 3.50../180LR

with release latch



Dimensioned drawing

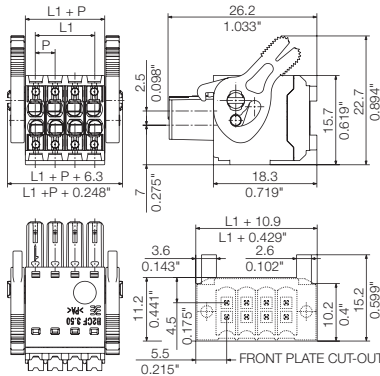

Ordering data

Solder pin length					
Colour	Orange	Black			
Pitch	3.50 mm				
Pol.	L1 (inch)	Qty.	Order No.	Order No.	
4	3.50	0.138	138	1278040000	1278230000
6	7.00	0.276	108	1278050000	1278240000
8	10.50	0.413	90	1278060000	1278250000
10	14.00	0.551	78	1278070000	1278260000
12	17.50	0.689	66	1278080000	1278270000
14	21.00	0.827	60	1278090000	1278280000
16	24.50	0.965	54	1278100000	1278290000
18	28.00	1.102	48	1278110000	1278300000
20	31.50	1.240	42	1278120000	1278310000
22	35.00	1.378	36	1278130000	1278320000
24	38.50	1.516	36	1278140000	1278340000
26	42.00	1.654	36	1278150000	1278350000
28	45.50	1.791	30	1278170000	1278370000
30	49.00	1.929	30	1278180000	1278380000
32	52.50	2.067	30	1278190000	1278390000
34	56.00	2.205	24	1278200000	1278400000
36	59.50	2.343	24	1278210000	1278410000

Release lever (LH) see Online catalogue

Double-row connectors in 3.50 mm pitch Series B2L/S2L 3.50

S2L 3.50/././90

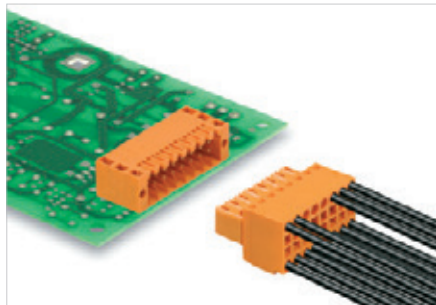

Angled, double-row male header. Male headers with 3.5 mm pins that are designed for wave soldering and are packaged in a box. Available in closed (G) version and with screw flange (F).

Product data

IEC: 250 V / 10 A

UL: 150 V / 10 A

For additional articles and information, refer to catalog.weidmuller.com

Note:

- Additional colours on request
- Gold-plated contact surfaces on request
- Spacing between rows: see hole layout
- Rated current related to rated cross-section & min. No. of poles.
- P on drawing = pitch
- Rated data refer only to the component itself. Clearance and creepage distances to other components are to be designed in accordance with the relevant application standards.

S2L 3.50/././90G

closed ends



Dimensioned drawing

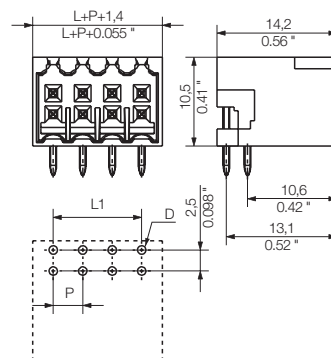



C

Technical data

In compliance with IEC 60664-1 / IEC 61984			
Clamping range, max.	mm ²		
Solid core H05(07) V-U	mm²		
Stranded H07 V-R			
Flexible H05(07) V-K	mm ²		
Flexible with ferrule	mm ²		
Ferrule with plastic collar	mm ²		
Stripping length	mm		
Screwdriver blade	mm		
According to norm			
Tightening torque range	Nm		
Rated current, max.	A	10	9
At ambient temperature		20°C	40°C
For conductor cross-section	mm ²		
Overvoltage category		III	III II
Pollution severity		3	2 2
Rated voltage	V	80	125 250
Rated impulse voltage	kV	2.5	2.5 2.5
UL / CUL (Use Group)	B C D		
Rated voltage	V	150	50
Rated current	A	10	10
AWG conductor	AWG		-
CSA (Use Group)	B C D		
Rated voltage	V	150	
Rated current	A	5	
AWG conductor	AWG		-
General data			
Type of insulation material		PBT	
UL 94 flammability rating		V-0	
Contact base material		Copper alloy	
Material of contact surface		tinned	
Pin dimensions = d	mm	1.0, Octagonal	
Solder eyelet Ø = D	mm	1.3	
Solder eyelet Ø tolerance	mm	+ 0,1	

Accessories

Note: Refer to the Accessories chapter for additional accessories.

Coding		Order No.
	B2L/S2L 3.5 KO OR	1849730000
	B2L/S2L 3.5 KO SW	1849740000
LED light guide		
	S2L 3.5 FLA 20/10	1699580000
Mounting screw		
	PTSC KA 2.2X4.5 WN1412	1610740000

Ordering data

Solder pin length		3.5 mm	3.5 mm		
Colour		Orange	Black		
Pitch 3.50 mm					
Pol.	L1	(inch)	Qty.	Order No.	Order No.
6	7.00	0.276	50	1727830000	1727990000
8	10.50	0.413	50	1727840000	1728000000
10	14.00	0.551	50	1727850000	1728010000
12	17.50	0.689	50	1727860000	1728020000
14	21.00	0.827	50	1727870000	1728030000
16	24.50	0.965	50	1727880000	1728040000
18	28.00	1.102	20	1727890000	1728050000
20	31.50	1.240	20	1727900000	1728060000
22	35.00	1.378	20	1727910000	1728070000
24	38.50	1.516	20	1727920000	1728080000
26	42.00	1.654	20	1727930000	1728090000
28	45.50	1.791	20	1727940000	1728100000
30	49.00	1.929	20	1727950000	1728110000
32	52.50	2.067	20	1727960000	1728120000
34	56.00	2.205	20	1727970000	1728130000
36	59.50	2.343	20	1727980000	1728140000

For open version, see online catalogue

S2L 3.50/./90F

with screw flange



Dimensioned drawing

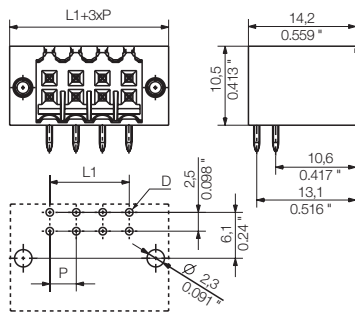

Ordering data

Solder pin length		3.5 mm	3.5 mm		
Colour		Orange	Black		
Pitch		3.50 mm			
Pol.	L1 (inch)	Qty.	Order No.	Order No.	
6	7.00	0.276	50	1728470000	1728630000
8	10.50	0.413	50	1728480000	1728640000
10	14.00	0.551	50	1728490000	1728650000
12	17.50	0.689	50	1728500000	1728660000
14	21.00	0.827	50	1728510000	1728670000
16	24.50	0.965	50	1728520000	1728680000
18	28.00	1.102	20	1728530000	1728690000
20	31.50	1.240	20	1728540000	1728700000
22	35.00	1.378	20	1728550000	1728710000
24	38.50	1.516	20	1728560000	1728720000
26	42.00	1.654	20	1728570000	1728730000
28	45.50	1.791	20	1728580000	1728740000
30	49.00	1.929	20	1728590000	1728750000
32	52.50	2.067	20	1728600000	1728760000
34	56.00	2.205	20	1728610000	1728770000
36	59.50	2.343	20	1728620000	1728780000

For open version, see online catalogue

Double-row connectors in 3.50 mm pitch Series B2L/S2L 3.50

S2L 3.50/././180

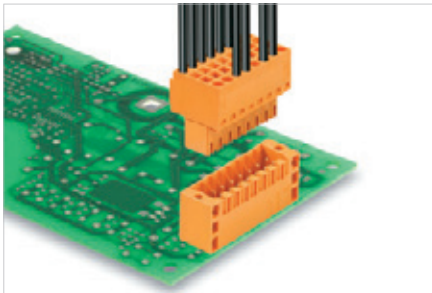

Straight, double-row male header. Male headers with 3.5 mm pins that are designed for wave soldering and are packaged in a box. The flange version can be screwed on the PCB. The pin headers provide space for labelling and can be coded. Available in closed (G) version and with screw flange (LF).

Technical data

In compliance with IEC 60664-1 / IEC 61984

Clamping range, max.	mm ²		
Solid core H05(07) V-U	mm²		
Stranded H07 V-R			
Flexible H05(07) V-K	mm ²		
Flexible with ferrule	mm ²		
Ferrule with plastic collar	mm ²		
Stripping length	mm		
Screwdriver blade	mm		
According to norm			
Tightening torque range	Nm		
Rated current, max.	A	10	9
At ambient temperature		20°C	40°C
For conductor cross-section	mm ²		
Overtolerance category		III	III II
Pollution severity		3	2 2
Rated voltage	V	80	125 250
Rated impulse voltage	kV	2.5	2.5 2.5
UL / CUL (Use Group)		B	C D
Rated voltage	V	150	50
Rated current	A	10	10
AWG conductor	AWG		-
CSA (Use Group)		B	C D
Rated voltage	V	150	
Rated current	A	5	
AWG conductor	AWG		-
General data			
Type of insulation material		PBT	
UL 94 flammability rating		V-0	
Contact base material		Copper alloy	
Material of contact surface		tinned	
Pin dimensions = d	mm	1.0, Octagonal	
Solder eyelet Ø = D	mm	1.3	
Solder eyelet Ø tolerance	mm	+ 0,1	

Product data

IEC: 250 V / 10 A

UL: 150 V / 10 A

For additional articles and information, refer to catalog.weidmueller.com

Note:

- Additional colours on request
- Gold-plated contact surfaces on request
- Spacing between rows: see hole layout
- Rated current related to rated cross-section & min. No. of poles.
- P on drawing = pitch
- Rated data refer only to the component itself. Clearance and creepage distances to other components are to be designed in accordance with the relevant application standards.

S2L 3.50/././180G

closed ends



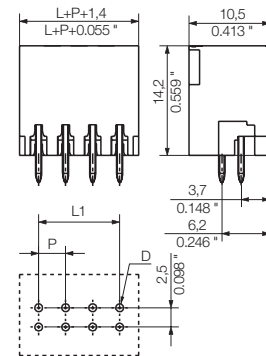

Dimensioned drawing



Accessories

Note: Refer to the Accessories chapter for additional accessories.

Coding		Order No.
	B2L/S2L 3.5 KO OR	1849730000
	B2L/S2L 3.5 KO SW	1849740000
Mounting screw		
	PTSC KA 2.2X4.5 WN1412	1610740000

Ordering data

Solder pin length	3.5 mm	3.5 mm		
Colour	Orange	Black		
Pitch	3.50 mm			
Pol.	L1 (inch)	Qty.	Order No.	Order No.
6	7.00 0.276	50	1728790000	1728950000
8	10.50 0.413	50	1728800000	1728960000
10	14.00 0.551	50	1728810000	1728970000
12	17.50 0.689	50	1728820000	1728980000
14	21.00 0.827	50	1728830000	1728990000
16	24.50 0.965	50	1728840000	1729000000
18	28.00 1.102	20	1728850000	1729010000
20	31.50 1.240	20	1728860000	1729020000
22	35.00 1.378	20	1728870000	1729030000
24	38.50 1.516	20	1728880000	1729040000
26	42.00 1.654	20	1728890000	1729050000
28	45.50 1.791	20	1728900000	1729060000
30	49.00 1.929	20	1728910000	1729070000
32	52.50 2.067	20	1728920000	1729080000

For open version, see online catalogue

S2L 3.50/./180F

with screw flange



Dimensioned drawing

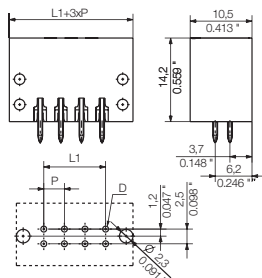

Ordering data

Solder pin length		3.5 mm	3.5 mm		
Colour		Orange	Black		
Pitch		3.50 mm			
Pol.	L1 (inch)	Qty.	Order No.	Order No.	
6	7.00	0.276	50	1729430000	1729590000
8	10.50	0.413	50	1729440000	1729600000
10	14.00	0.551	50	1729450000	1729610000
12	17.50	0.689	50	1729460000	1729620000
14	21.00	0.827	50	1729470000	1729630000
16	24.50	0.965	50	1729480000	1729640000
18	28.00	1.102	20	1729490000	1729650000
20	31.50	1.240	20	1729500000	1729660000
22	35.00	1.378	20	1729510000	1729670000
24	38.50	1.516	20	1729520000	1729680000
26	42.00	1.654	20	1729530000	1729690000
28	45.50	1.791	20	1729540000	1729700000
30	49.00	1.929	20	1729550000	1729710000
32	52.50	2.067	20	1729560000	1729720000
34	56.00	2.205	20	1729570000	1729730000
36	59.50	2.343	20	1729580000	1729740000

For open version, see online catalogue

Double-row connectors in 3.50 mm pitch Series B2L/S2L 3.50

B2L 3.50/./180 QV

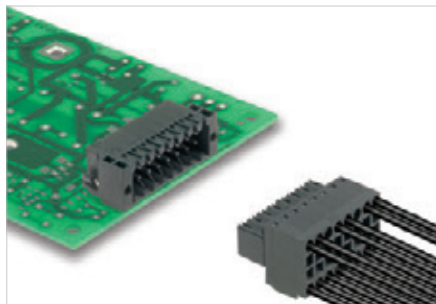

Female plugs with integral cross-connection.

- Cross-connection is positioned vertically between the poles of rows directly on top of each other.
- Tension clamp connection with straight outlet and 3.5 mm pitch.
- Flange (F) and release lever (LH) available.

Product data

IEC: 200 V / 10.6 A / 0.2 - 1 mm²
UL: 150 V / 7 A / AWG 28 - 18

For additional articles and information, refer to catalog.weidmueller.com

Note:

- Additional colours on request
- Gold-plated contact surfaces on request
- Rated current related to rated cross-section & min. No. of poles.
- Wire end ferrule with plastic collar to DIN 46228/4
- Wire end ferrule without plastic collar to DIN 46228/1
- P on drawing = pitch
- We recommend crimp shape A for wire-end ferrules with crimping tool PZ 6/5 (order no. 9011460000) for the larger wire cross-sections.
- Rated data refer only to the component itself. Clearance and creepage distances to other components are to be designed in accordance with the relevant application standards.

B2L 3.50/./180QV

with cross-connection



Dimensioned drawing

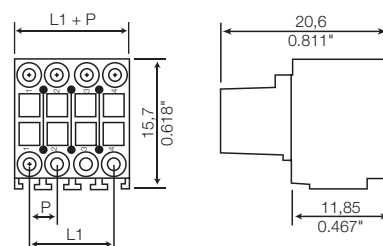





















Technical data

In compliance with IEC 60664-1 / IEC 61984			
Clamping range, max.	mm ²	0.08...1	
Solid core H05(07) V-U	mm ²	0.2...1	
Stranded H07 V-R			
Flexible H05(07) V-K	mm ²	0.2...1	
Flexible with ferrule	mm ²	0.13...0.34	
Ferrule with plastic collar	mm ²	0.13...0.34	
Stripping length	mm	7	
Screwdriver blade	mm		
According to norm			
Tightening torque range	Nm		
Rated current, max.	A	10.6	9.1
At ambient temperature		20°C	40°C
For conductor cross-section	mm ²	1	
Overvoltage category		III	III II
Pollution severity		3	2 2
Rated voltage	V	80	160 200
Rated impulse voltage	kV	1.5	2.5 2.5
UL / CUL (Use Group)		B	C D
Rated voltage	V	150	50
Rated current	A	7	7
AWG conductor	AWG	28-18	
CSA (Use Group)		B	C D
Rated voltage	V	300	
Rated current	A	7	
AWG conductor	AWG	28-18	
General data			
Type of insulation material		PBT	
UL 94 flammability rating		V-0	
Contact base material		Copper alloy	
Material of contact surface		tinned	
Pin dimensions = d	mm		
Solder eyelet Ø = D	mm		
Solder eyelet Ø tolerance	mm		

Accessories

Note: Refer to the Accessories chapter for additional accessories.

Coding	Order No.
 B2L/S2L 3.5 KO OR	1849730000
 B2L/S2L 3.5 KO SW	1849740000
Hood	
 B2L 3.50-AH 10 SW	1781580000
 B2L 3.50-AH 12 SW	1781590000
 B2L 3.50-AH 14 SW	1781600000
 B2L 3.50-AH 16 SW	1781610000
 B2L 3.50-AH 18 SW	1781620000
 B2L 3.50-AH 20 SW	1781630000
 B2L 3.50-AH 22 SW	1781640000
 B2L 3.50-AH 24 SW	1781650000
 B2L 3.50-AH 26 SW	1781660000
 B2L 3.50-AH 28 SW	1781670000
 B2L 3.50-AH 30 SW	1781680000
 B2L 3.50-AH 32 SW	1781690000
 B2L 3.50-AH 34 SW	1781700000
 B2L 3.50-AH 36 SW	1781710000
 B2L 3.50-AH 6 SW	1781560000
 B2L 3.50-AH 8 SW	1781570000
Screwdriver	
 SDS 0.4X2.5X75	9009030000
Crimping tool	
 PZ 1.5	9005990000
 PZ 6/5	9011460000

Ordering data

Solder pin length					
Colour	Black				
Pitch	3.50 mm				
Pol.	L1	(inch)	Qty.	Order No.	
6	7.00	0.276	50	1944590000	
8	10.50	0.413	50	1944600000	
10	14.00	0.551	50	1944610000	
12	17.50	0.689	50	1944620000	
14	21.00	0.827	20	1944630000	
16	24.50	0.965	20	1944640000	
18	28.00	1.102	20	1944650000	

Representative deratings curve

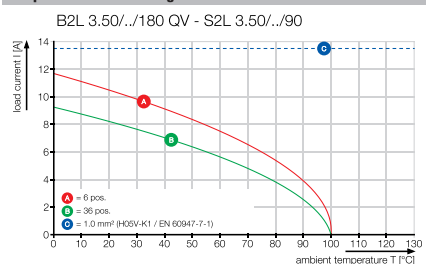

B2L 3.50/./180FQV

with cross-connection and flange



Dimensioned drawing

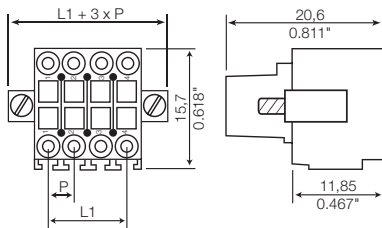

B2L 3.50/./180LHQV

with cross-connection and release lever



Dimensioned drawing

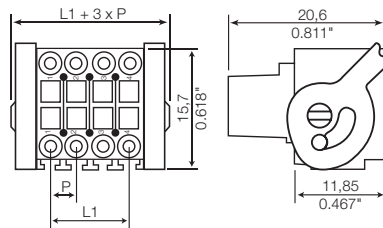

Ordering data

Solder pin length					
Colour					Black
Pitch 3.50 mm					
Pol.	L1	(inch)	Qty.	Order No.	
6	7.00	0.276	50	1944670000	
8	10.50	0.413	50	1944680000	
10	14.00	0.551	50	1944690000	
12	17.50	0.689	50	1944700000	
14	21.00	0.827	20	1944710000	
16	24.50	0.965	20	1944720000	
18	28.00	1.102	20	1944730000	

Ordering data

Solder pin length					
Colour					Black
Pitch 3.50 mm					
Pol.	L1	(inch)	Qty.	Order No.	
6	7.00	0.276	50	1944750000	
8	10.50	0.413	50	1944760000	
10	14.00	0.551	50	1944770000	
12	17.50	0.689	50	1944780000	
14	21.00	0.827	20	1944790000	
16	24.50	0.965	20	1944800000	
18	28.00	1.102	20	1944810000	

Excellent design & performance: the single row SL/BL Connector system with 3.50 pitch and the connection of I/Os

Extensive range of male headers and female plugs that cover different angles to the PCB and conductor angle to the field as well as a large range of accessories make the 3.50 mm pitch very versatile.

Strong in performance and connections, compact in its size:

- Wire cross-sections from 0.20 to 1.5 mm² (AWG 28-14)
- Wire connection without special tools
- More than just extra-low voltages: up to 250 V (IEC) / 300 V (UL)
- More than enough: up to 17 A (IEC) / 10 A (UL)

Reliable connection technology

Decide on the best connection technology such as the service-free standard: Weidmüller clamping yoke connection with 100 % reliability and 100 % work output: steel for strength and copper for current.

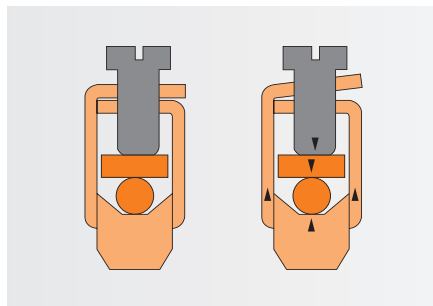

Maximum packing density

Either in a device using double layer male headers SLD or in the field using a 3 row socket connector BL-I/O.

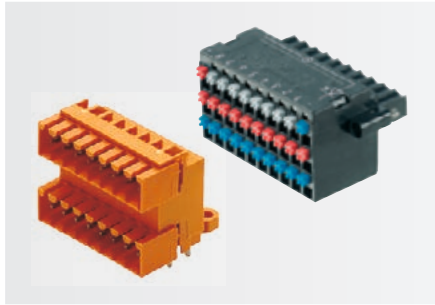
**Advanced application possibilities**

The extensive range of accessories increases the versatility and permits any desired combination of male headers and female plugs.

**Versatile field connection**

Choose your individual connection from the classic screw connection BL, the future-proof PUSH IN connection BL-I/O, the proven tension-clamp system BLZF or the quick connection BLIDCB.

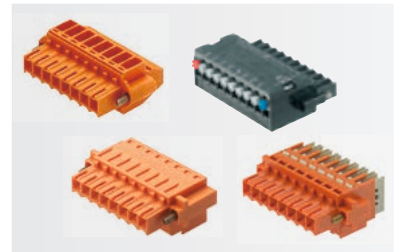
**Optimum processing**

The tape-on-reel packaging for high temperature-resistant male headers made of LCP guarantees a suitable product for automated processing. The integrated solder flange significantly increases the PCB's stability and replaces the screw that would normally be added later.

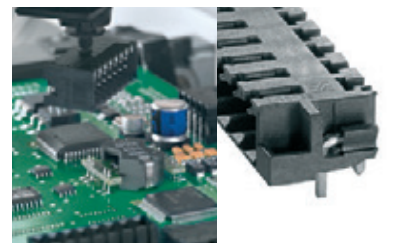
**Release latch or screw flange**

The release latch guarantees a good connection between the female plug and the device and also, particularly for systems with many pins, ensures an assembly protecting release of the connection. The screw flange creates a vibration and shake-proof connection between the panel connection and the device.

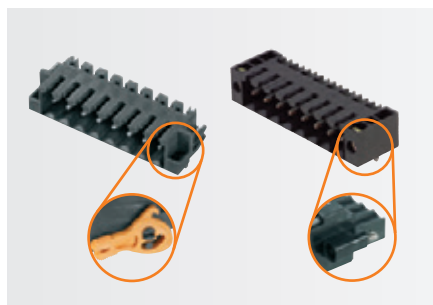

Small – smaller – BL-I/O: minimal size – maximum functionality

You have a free choice for the field wiring: whether you prefer the compact version with our 3 row female plug BL-I/O 3.50/30-poles or rather conventional systems with terminals or interface modules lowercase's. Since the female plug BL-I/O 3.50 based I/O systems are backwards compatible with existing field connections.

The female plug BL-I/O 3.50 mm pitch is an

- extremely compact,
 - 1 or 3 row female plug
- suitable for connection of remote sensors and/or actuators with
- integrated LED display
 - integrated cross-connections for potential distribution.

For efficient remote functional units in the field level the female plug BL-I/O 3.50 is a space saving solution to connect I/O components.

Savings from the female connector BL-I/O are apparent in the development and the manufacturing of the PCB. The layout is simplified by 62 % and fewer layers are required.

Multiply your potential

Special cross-connectors, that are integrated into the second and third rows of the female plug, distribute the supply voltage to the individual I/O channels. In this way you can input, transfer or bridge the supply voltage. Thus you can save space with the I/O electronics, and you can reduce your wiring overhead.

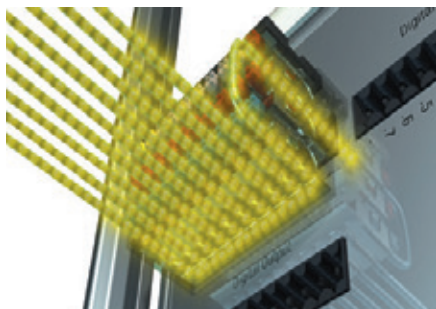

... as simple as that

Simply insert solid or flexible conductors with ferrules. The simple pressing of one button opens the terminal connections and allows you to insert the flexible wire without ferrules in no time at all. Disconnecting the wire is just as easy: press the button and pull out the wire.

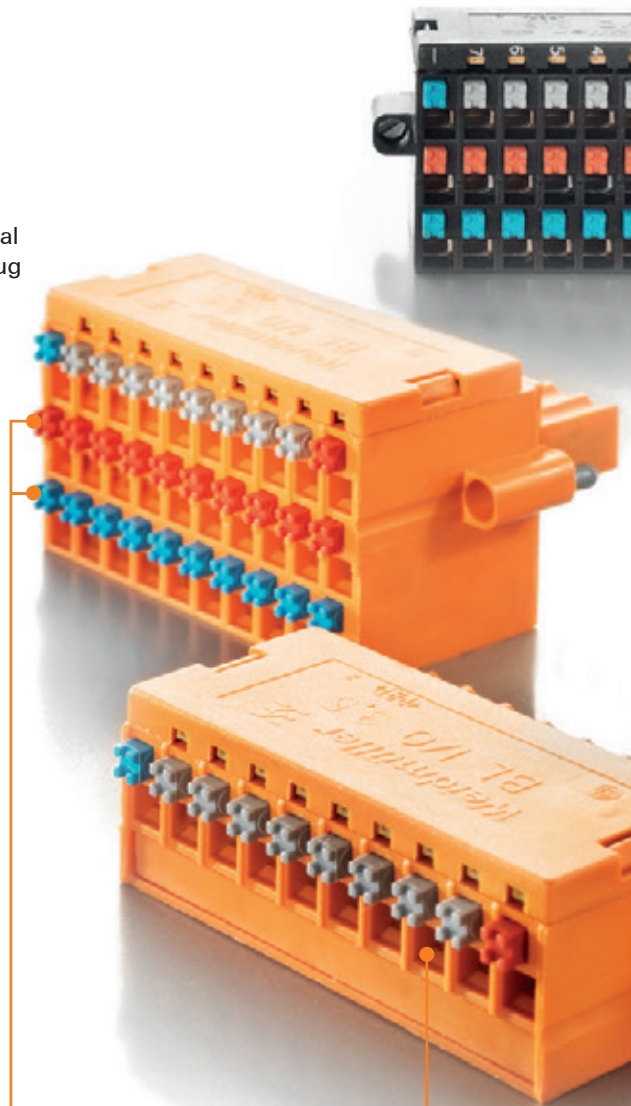
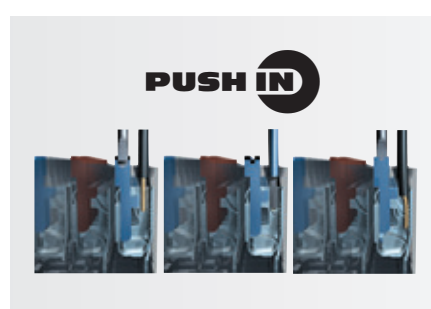

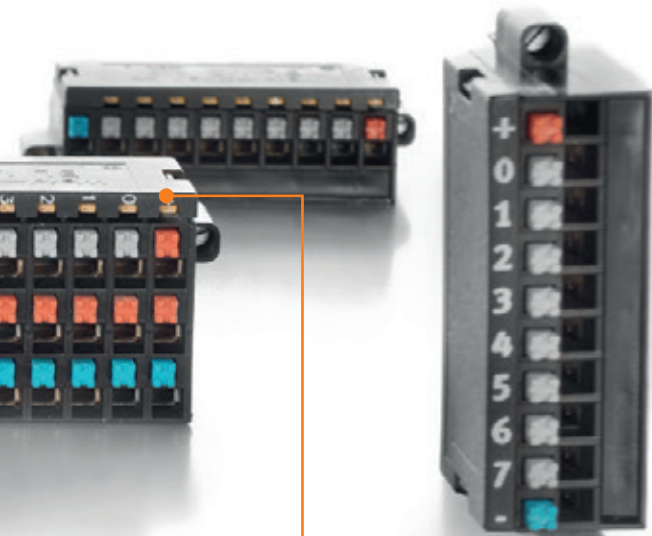
**Intuitive locking and releasing**

The 3 row female plug BL-I/O 3.50/30/180LR with lock & release lever to allow tool free interlocking and electronic assembly protecting release with the new male header SL-SMT 3.50/10/..RF with clip-on flange

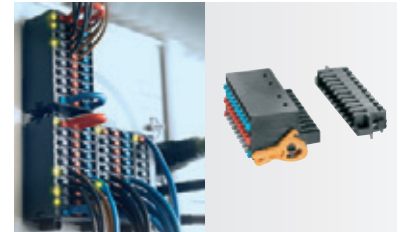
**Rugged screw flange**

The 3 row female plug BL-I/O 3-5/30/180F with screw flange for vibration and shock resistant interlocking in conjunction with the male header SL-SMT 3.50/10/..LF with solder flange.

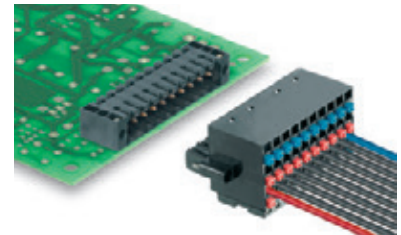
**Screwless PCB fastening - suitable for automatic assembly**



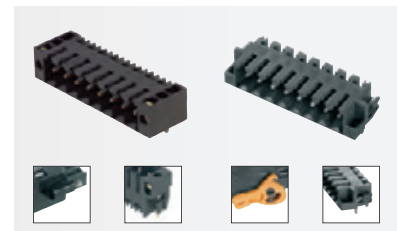

The male header SL-SMT has a clip-on flange for the release latch and is available as solder flange variant for the screw flange. In both variants the extra solder pin replaces the screw that would have to be added later and significantly increases the mechanical stability to the PCB.

**Integrated LEDs**

Since power is supplied directly through the female plug BL-I/O 3.50, functional control of the sensor wiring is possible without any additionally connected I/O electronics. That simplifies initial commissioning and also clears up space on the control unit.



<http://www.OMNIMATE.net>

-  = Wire-to-Board
-  = Board-to-Board
-  = Wire-to-Wire
-  = Board-to-Wire

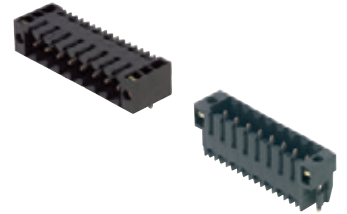
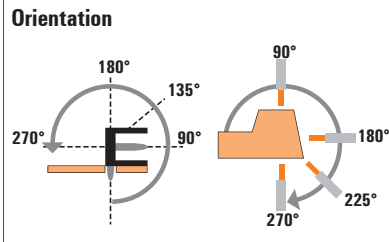

C

BL/SL 3.50 series



Type	Levels	
	1	
	SL-SMT	SL-SMT
	90°	180°
Orientation	G/F/LF/RF	G/F/LF
Flange options	IEC: 320 V/15 A UL: 300 V/10 A	IEC: 320 V/15 A UL: 300 V/10 A
IEC / UL	C.26	C.29
Page		

Female plug	Type	Orientation	Flange options	IEC / UL	Page	Levels	
						SL-SMT	SL-SMT
Screw: Clamping yoke	 BL	180°	(G)/F/LH/LR	IEC: 320 V/17 A/0.2 - 1.5 mm ² UL: 300 V/10 A/AWG 28 - 14	C.44		
	 BL	90°	(G)/F	IEC: 320 V/12 A/0.2 - 1.5 mm ² UL: 300 V/8 A/AWG 28 - 14	C.46		
	 BL	270°	(G)/F	IEC: 320 V/12 A/0.2 - 1.5 mm ² UL: 300 V/8 A/AWG 28 - 14	C.47		
Tension clamp	 BLZF	180°	(G)/F/LH/LR	IEC: 320 V/14.5 A/0.2 - 1.5 mm ² UL: 300 V/10 A/AWG 26 - 14	C.48		
IDC Bus	 BLIDCB	180°	(G)/F	IEC: 250 V/6 A/0.35 - 0.5 mm ² UL: 300 V/7 A/AWG 22 - 20	C.50		
Spring: PUSH IN	 BL-I/O 10 Pole	180°	F/LR/FP	IEC: 200 V/2.2 A/0.2 - 1.0 mm ² UL: ≤ 200 V/5 A/AWG 22 - 16	C.52		
	 BL-I/O 30 Pole	180°	F/LR/FP	IEC: 200 V/2.2 A/0.2 - 1.0 mm ² UL: ≤ 200 V/5 A/AWG 22 - 16	C.53		

Female plug:
(G)* = Closed (without flange)
F = Screw flange with screw
LH = Release lever
LR = Lock & Release lever
FP = shifted flange

Male header:
(O)* = open
G = Closed (without flange)
F = Flange with nut
LF = Solder flange with nut
RF = Locking flange for LR with solder pin

* not included in the article description

Male header



Solder connection

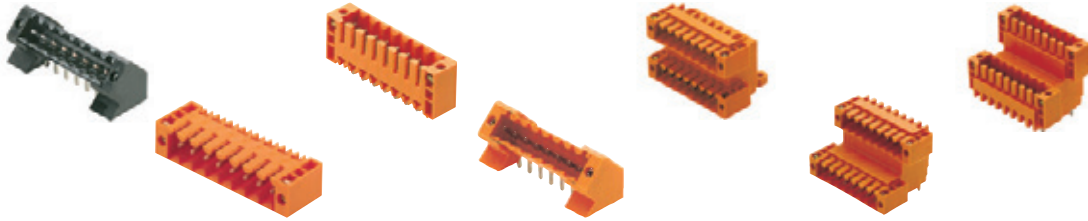

1		1			2		
SL-THR	SL	SL	SL	SLD	SLD V	SLD V	
135°	90°	180°	135°	90°	90°	180°	
F	(0)/G/F	(0)/G/F	F	G/F	G/F	G/F	
IEC: 320 V/15 A UL: 300 V/10 A	IEC: 320 V/15 A UL: 300 V/10 A	IEC: 320 V/15 A UL: 300 V/10 A	IEC: 320 V/15 A UL: 300 V/10 A	IEC: 200 V/10.5 A UL: 300 V/8 A	IEC: 200 V/10.5 A UL: 300 V/8 A	IEC: 200 V/10.5 A UL: 300 V/8 A	
C.37	C.32	C.34	C.36	C.38	C.40	C.42	
○	○	○	○	○	○	○	
○	○	○	○	○	○	○	
○	○	○	○	○	○	○	
○	○	○	○	○	○	○	
○	○	○	○	○	○	○	
○	○	○	○	○	○	○	
○	○	○	○	○	○	○	

SL-SMT 3.50/./90

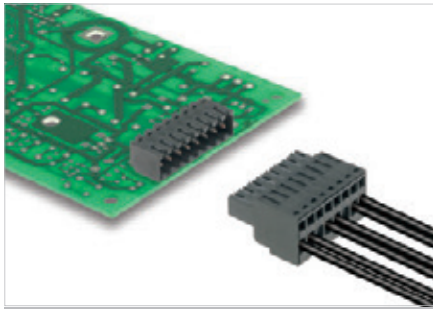

High-temperature-resistant, angled, male header for all common soldering methods in 3.5 mm pitch.

- Optimised for SMT processing.
- 3.2 mm older pin suitable for reflow and wave soldering.
- The Male headers provide space for labelling and can be coded.
- Available in closed (G) version and with solder flange (LF).
- Packed either in box (BX) or on tape-on-reel (RL).

Technical data

In compliance with IEC 60664-1 / IEC 61984			
Clamping range, max.	mm ²		
Solid core H05(07) V-U	mm²		
Stranded H07 V-R			
Flexible H05(07) V-K	mm ²		
Flexible with ferrule	mm ²		
Ferrule with plastic collar	mm ²		
Stripping length	mm		
Screwdriver blade	mm		
According to norm			
Tightening torque range	Nm		
Rated current, max.	A	15	13
At ambient temperature		20°C	40°C
For conductor cross-section	mm ²		
Overvoltage category		III	III II
Pollution severity		3	2 2
Rated voltage	V	160	160 320
Rated impulse voltage	kV	2.5	2.5 2.5
UL / CUL (Use Group)		B	C D
Rated voltage	V	300	300
Rated current	A	10	10
AWG conductor	AWG		
CSA (Use Group)		B	C D
Rated voltage	V	300	300
Rated current	A	10	10
AWG conductor	AWG		
General data			
Type of insulation material		LCP GF	
UL 94 flammability rating		V-0	
Contact base material		CuSn	
Material of contact surface		tinned	
Pin dimensions = d	mm	1.2, Octagonal	
Solder eyelet Ø = D	mm	1.4	
Solder eyelet Ø tolerance	mm	+ 0,1	

Product data

IEC: 320 V / 15 A
UL: 300 V / 10 A

For additional articles and information, refer to catalog.weidmueller.com

Note:

- Gold-plated contact surfaces on request
- Rated current related to rated cross-section & min. No. of poles.
- Diameter of solder eyelet D = 1.5+0.1 mm from 9-pole
- P on drawing = pitch
- Rated data refer only to the component itself. Clearance and creepage distances to other components are to be designed in accordance with the relevant application standards.

SL-SMT 3.50/./90G Box

closed side



Dimensioned drawing

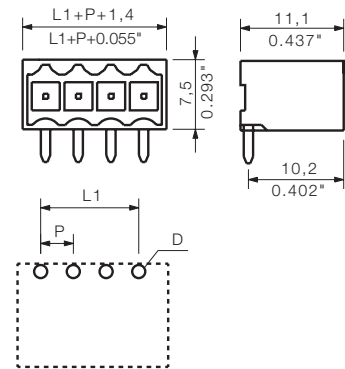

Accessories

Note: Refer to the Accessories chapter for additional accessories.

Coding		Order No.
	BL SL 3.5 KO OR	1693430000
	BL SL 3.5 KO SW	1610100000
Interlock		
	BL/SL 3.5 VR OR	1669310000
	BL/SL 3.5 VR SW	1669300000
LED light guide		
	SL 3.5 FLA 1.5/1.75/8	1597630000
	SL 3.5 FLA 1.5/8	1597510000
	SL 3.5 FLA 2.3/1.75/8	1597640000
	SL 3.5 FLA 2.3/8	1597520000
	SL 3.5 FLA 4.0/1.75/8	1597650000
SL 3.5 FLA 4.0/8	1597530000	
Mounting screw		
	PTSC KA 2.2X4.5 WN1412	1610740000

Ordering data

Solder pin length		1.5 mm	3.2 mm
Colour		Black	Black
Pitch 3.50 mm			
Pol.	L1	(inch)	Qty. Order No. Order No.
2	3.50	0.138	100 1761542001 1841630000
3	7.00	0.276	100 1761552001 1841640000
4	10.50	0.413	100 1761562001 1841650000
5	14.00	0.551	50 1761572001 1841660000
6	17.50	0.689	50 1761582001 1841670000
7	21.00	0.827	50 1761592001 1841680000
8	24.50	0.965	50 1761602001 1841690000
9	28.00	1.102	50 1761612001 1841700000
10	31.50	1.240	50 1761622001 1841710000
11	35.00	1.378	50 1761632001 1841720000
12	38.50	1.516	50 1761642001 1841730000
13	42.00	1.654	50 1761652001 1841740000
14	45.50	1.791	50 1761662001 1841750000
15	49.00	1.929	50 1761672001 1841760000
16	52.50	2.067	50 1761682001 1841770000
17	56.00	2.205	20 1761692001 1841780000
18	59.50	2.343	20 1761702001 1841790000
19	63.00	2.480	20 1761712001 1841800000
20	66.50	2.618	20 1761722001 1841810000
21	70.00	2.756	20 1761732001 1841820000
22	73.50	2.894	20 1761742001 1841830000
23	77.00	3.031	20 1761752001 1841840000
24	80.50	3.169	20 1761762001 1841850000

SL-SMT 3.50/./90G Tape

closed side; tape-on-reel



Dimensioned drawing

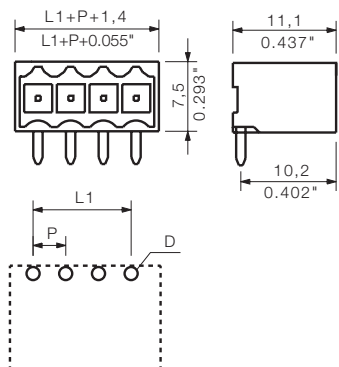

Ordering data

Solder pin length		1.5 mm		
Colour		Black		
Pitch		3.50 mm		
Pol.	L1	(inch)	Qty.	Order No.
2	3.50	0.138	385	1761544002
3	7.00	0.276	385	1761554002
4	10.50	0.413	385	1761564002
5	14.00	0.551	385	1761574002
6	17.50	0.689	385	1761584001
7	21.00	0.827	385	1761594001
8	24.50	0.965	385	1761604001
9	28.00	1.102	385	1761614001
10	31.50	1.240	385	1761624001
11	35.00	1.378	385	1761634001

Tape widths: 32, 44, 56, 72, 88

SL-SMT 3.50/./90LF Box

with solder flange



Dimensioned drawing

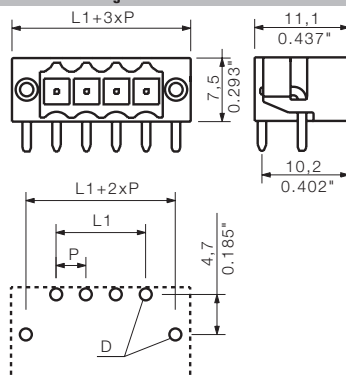

Ordering data

Solder pin length		1.5 mm		3.2 mm	
Colour		Black		Black	
Pitch		3.50 mm			
Pol.	L1	(inch)	Qty.	Order No.	Order No.
2	3.50	0.138	100	1804940000	1841860000
3	7.00	0.276	100	1804950000	1841870000
4	10.50	0.413	100	1804960000	1841880000
5	14.00	0.551	50	1804970000	1841890000
6	17.50	0.689	50	1804980000	1841900000
7	21.00	0.827	50	1804990000	1841910000
8	24.50	0.965	50	1805000000	1841920000
9	28.00	1.102	50	1805010000	1841930000
10	31.50	1.240	50	1805020000	1841940000
11	35.00	1.378	50	1805030000	1841950000
12	38.50	1.516	50	1805040000	1804340000
13	42.00	1.654	50	1805050000	1841960000
14	45.50	1.791	50	1805060000	1841970000
15	49.00	1.929	50	1805070000	1841980000
16	52.50	2.067	50	1805080000	1841990000
17	56.00	2.205	20	1805090000	1842000000
18	59.50	2.343	20	1805100000	1842010000
19	63.00	2.480	20	1805110000	1842020000
20	66.50	2.618	20	1805120000	1842030000
21	70.00	2.756	20	1805130000	1842040000
22	73.50	2.894	20	1805140000	1842050000
23	77.00	3.031	20	1805150000	1842060000
24	80.50	3.169	20	1805160000	1842070000

SL-SMT 3.50/./90LF Tape

with solder flange; tape-on-reel



Dimensioned drawing

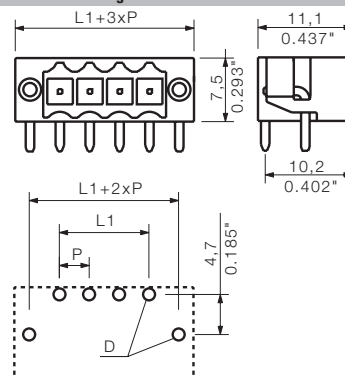

Ordering data

Solder pin length		1.5 mm		
Colour		Black		
Pitch		3.50 mm		
Pol.	L1	(inch)	Qty.	Order No.
2	3.50	0.138	385	1805310000
3	7.00	0.276	385	1805320000
4	10.50	0.413	385	1805330000
5	14.00	0.551	385	1805340000
6	17.50	0.689	385	1805350000
7	21.00	0.827	385	1805360000
8	24.50	0.965	385	1805370000
9	28.00	1.102	385	1805380000
10	31.50	1.240	385	1005180000

Tape widths: 32, 44, 56, 72, 88

SL-SMT 3.50/./ F & RF

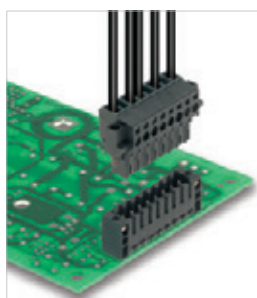

High-temperature-resistant, straight and angled, male header for all common soldering methods in 3.5 mm pitch.

- Optimised for the SMT processing.
- 3.2 mm solder pin suitable for reflow and wave soldering.
- Available in screw flange (F) and with solder flange for lock and release lever (RF).

Technical data

In compliance with IEC 60664-1 / IEC 61984			
Clamping range, max.	mm ²		
Solid core H05(07) V-U	mm ²		
Stranded H07 V-R			
Flexible H05(07) V-K	mm ²		
Flexible with ferrule	mm ²		
Ferrule with plastic collar	mm ²		
Stripping length	mm		
Screwdriver blade	mm		
According to norm			
Tightening torque range	Nm		
Rated current, max.	A	15	13
At ambient temperature		20°C	40°C
For conductor cross-section	mm ²		
Overvoltage category		III	III II
Pollution severity		3	2 2
Rated voltage	V	160	160 320
Rated impulse voltage	kV	2.5	2.5 2.5
UL / CUL (Use Group)		B	C D
Rated voltage	V	300	300
Rated current	A	10	10
AWG conductor	AWG		
CSA (Use Group)		B	C D
Rated voltage	V	300	300
Rated current	A	10	10
AWG conductor	AWG		
General data			
Type of insulation material		LCP GF	
UL 94 flammability rating		V-0	
Contact base material		CuSn	
Material of contact surface		tinned	
Pin dimensions = d	mm	1.2, Octagonal	
Solder eyelet Ø = D	mm	1.4	
Solder eyelet Ø tolerance	mm	+ 0,1	

Product data

IEC: 320 V / 15 A
UL: 300 V / 10 A

For additional articles and information, refer to catalog.weidmueller.com

Note:

- Gold-plated contact surfaces on request
- Rated current related to rated cross-section & min. No. of poles.
- Diameter of solder eyelet D = 1.5+0.1mm from 9-pole
- P on drawing = pitch
- Rated data refer only to the component itself. Clearance and creepage distances to other components are to be designed in accordance with the relevant application standards.

SL-SMT 3.50/./90F Box

with screw flange



Dimensioned drawing

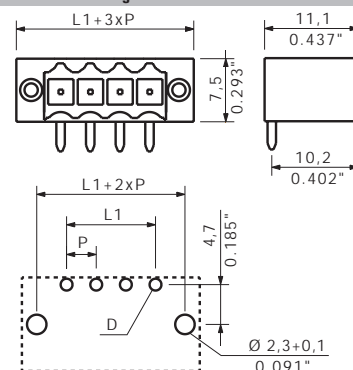

Accessories

Note: Refer to the Accessories chapter for additional accessories.

Coding		Order No.
	BL SL 3.5 KO OR	1693430000
	BL SL 3.5 KO SW	1610100000
Interlock		
	BL/SL 3.5 VR OR	1669310000
	BL/SL 3.5 VR SW	1669300000
LED light guide		
	SL 3.5 FLA 1.5/1.75/8	1597630000
	SL 3.5 FLA 1.5/8	1597510000
	SL 3.5 FLA 2.3/1.75/8	1597640000
	SL 3.5 FLA 2.3/8	1597520000
	SL 3.5 FLA 4.0/1.75/8	1597650000
	SL 3.5 FLA 4.0/8	1597530000

Ordering data

Solder pin length		3.2 mm		
Colour		Black		
Pitch 3.50 mm				
Pol.	L1	(inch)	Qty.	Order No.
2	3.50	0.138	100	1842080000
3	7.00	0.276	100	1842090000
4	10.50	0.413	100	1842100000
5	14.00	0.551	50	1842110000
6	17.50	0.689	50	1842120000
7	21.00	0.827	50	1842130000
8	24.50	0.965	50	1842140000
9	28.00	1.102	50	1842150000
10	31.50	1.240	50	1842160000
11	35.00	1.378	50	1842170000
12	38.50	1.516	50	1842180000
13	42.00	1.654	50	1842190000
14	45.50	1.791	50	1842200000
15	49.00	1.929	50	1842210000
16	52.50	2.067	50	1842220000
17	56.00	2.205	20	1842230000
18	59.50	2.343	20	1842240000
19	63.00	2.480	20	1842250000
20	66.50	2.618	20	1842260000
21	70.00	2.756	20	1842270000
22	73.50	2.894	20	1842280000
23	77.00	3.031	20	1842290000
24	80.50	3.169	20	1842300000

SL-SMT 3.50/./90RF Box

with snap-on solder flange



Dimensioned drawing

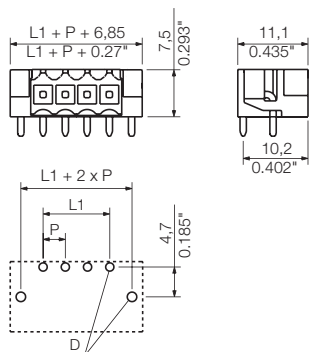

Ordering data

Solder pin length		1.5 mm			
Colour		Black			
Pitch		3.50 mm			
Pol.	L1	(inch)	Qty.	Order No.	
2	3.50	0.138	100	1379610000	
3	7.00	0.276	100	1060810000	
4	10.50	0.413	100	1000600000	
5	14.00	0.551	50	1000610000	
6	17.50	0.689	50	1000620000	
7	21.00	0.827	50	1000630000	
8	24.50	0.965	50	1000640000	
9	28.00	1.102	50	1000650000	
10	31.50	1.240	50	1060780000	
11	35.00	1.378	50	1000660000	
12	38.50	1.516	50	1000670000	
13	42.00	1.654	50	1000680000	
14	45.50	1.791	50	1000690000	
15	49.00	1.929	50	1000700000	
16	52.50	2.067	50	1060820000	

Compatible with release latch (LR)

SL-SMT 3.50/./180F Box

with screw flange



Dimensioned drawing

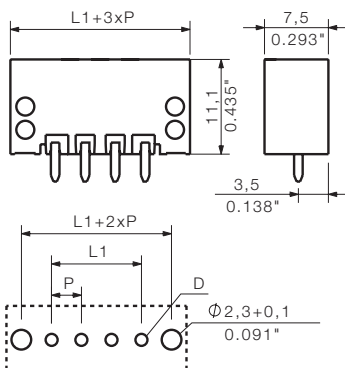

Ordering data

Solder pin length		3.2 mm			
Colour		Black			
Pitch		3.50 mm			
Pol.	L1	(inch)	Qty.	Order No.	
2	3.50	0.138	100	1842770000	
3	7.00	0.276	100	1842780000	
4	10.50	0.413	100	1842790000	
5	14.00	0.551	50	1842800000	
6	17.50	0.689	50	1842810000	
7	21.00	0.827	50	1842820000	
8	24.50	0.965	50	1842830000	
9	28.00	1.102	50	1842840000	
10	31.50	1.240	50	1842850000	
11	35.00	1.378	50	1842860000	
12	38.50	1.516	50	1842870000	
13	42.00	1.654	50	1842880000	
14	45.50	1.791	50	1842890000	
15	49.00	1.929	50	1842900000	
16	52.50	2.067	50	1842910000	
17	56.00	2.205	20	1842920000	
18	59.50	2.343	20	1842930000	
19	63.00	2.480	20	1842940000	
20	66.50	2.618	20	1842950000	
21	70.00	2.756	20	1842960000	
22	73.50	2.894	20	1842970000	
23	77.00	3.031	20	1842980000	
24	80.50	3.169	20	1842990000	

SL-SMT 3.50/./180

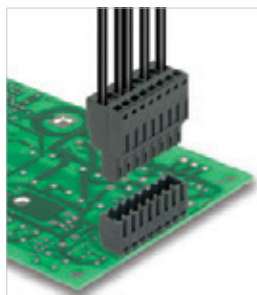

High-temperature-resistant, straight male header in 3.50 mm pitch for all conventional soldering methods.

- Optimised for the SMT processing.
- 3.2 mm solder pin suitable for reflow and wave soldering.
- Available in screw flange (F) and with solder flange (LF).
- Packed either in box (BX) or on tape-on-reel (RL).

Technical data

In compliance with IEC 60664-1 / IEC 61984			
Clamping range, max.	mm ²		
Solid core H05(07) V-U	mm²		
Stranded H07 V-R			
Flexible H05(07) V-K	mm ²		
Flexible with ferrule	mm ²		
Ferrule with plastic collar	mm ²		
Stripping length	mm		
Screwdriver blade	mm		
According to norm			
Tightening torque range	Nm		
Rated current, max.	A	15	13
At ambient temperature		20°C	40°C
For conductor cross-section	mm ²		
Overtolerance category		III	III II
Pollution severity		3	2 2
Rated voltage	V	160	160 320
Rated impulse voltage	kV	2.5	2.5 2.5
UL / CUL (Use Group)		B	C D
Rated voltage	V	300	300
Rated current	A	10	10
AWG conductor	AWG		
CSA (Use Group)		B	C D
Rated voltage	V	300	300
Rated current	A	10	10
AWG conductor	AWG		
General data			
Type of insulation material		LCP GF	
UL 94 flammability rating		V-0	
Contact base material		CuSn	
Material of contact surface		tinned	
Pin dimensions = d	mm	1.2, Octagonal	
Solder eyelet Ø = D	mm	1.4	
Solder eyelet Ø tolerance	mm	+ 0,1	

Product data

IEC: 320 V / 15 A
UL: 300 V / 10 A

For additional articles and information, refer to catalog.weidmueller.com

Note:

- Gold-plated contact surfaces on request
- Rated current related to rated cross-section & min. No. of poles.
- Diameter of solder eyelet D = 1.5+0.1 mm from 9-pole
- P on drawing = pitch
- Rated data refer only to the component itself. Clearance and creepage distances to other components are to be designed in accordance with the relevant application standards.

SL SMT 3.50/./180G Box

with solder flange



Dimensioned drawing

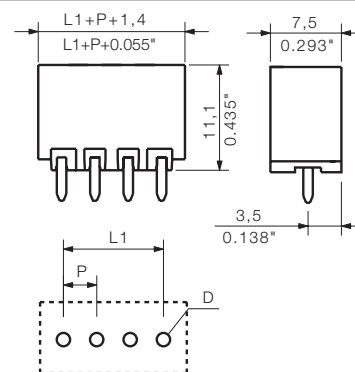

Accessories

Note: Refer to the Accessories chapter for additional accessories.

Coding		Order No.
	BL SL 3.5 KO OR	1693430000
	BL SL 3.5 KO SW	1610100000
Interlock		
	BL/SL 3.5 VR OR	1669310000
	BL/SL 3.5 VR SW	1669300000

Ordering data

Solder pin length		1.5 mm	3.2 mm		
Colour		Black	Black		
Pitch 3.50 mm					
Pol.	L1	(inch)	Qty.	Order No.	Order No.
2	3.50	0.138	100	1752982001	1842320000
3	7.00	0.276	100	1752992001	1842330000
4	10.50	0.413	100	1753002001	1842340000
5	14.00	0.551	50	1753012001	1842350000
6	17.50	0.689	50	1753022001	1842360000
7	21.00	0.827	50	1753032001	1842370000
8	24.50	0.965	50	1753042001	1842380000
9	28.00	1.102	50	1753052001	1842390000
10	31.50	1.240	50	1753062001	1836990000
11	35.00	1.378	50	1753072001	1842400000
12	38.50	1.516	50	1753082001	1842410000
13	42.00	1.654	50	1753092001	1842420000
14	45.50	1.791	50	1753102001	1842430000
15	49.00	1.929	50	1753112001	1842440000
16	52.50	2.067	50	1753122001	1842450000
17	56.00	2.205	20	1753132001	1842460000
18	59.50	2.343	20	1753142001	1842470000
19	63.00	2.480	20	1753152001	1842480000
20	66.50	2.618	20	1753162001	1842490000
21	70.00	2.756	20	1753172001	1842500000
22	73.50	2.894	20	1753182001	1842510000
23	77.00	3.031	20	1753192001	1842520000
24	80.50	3.169	20	1753202001	1842530000

SL SMT 3.50/./180G Tape

with solder flange



Dimensioned drawing

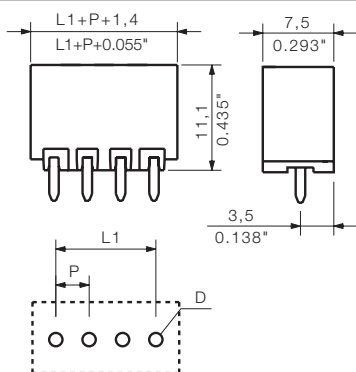

Ordering data

Solder pin length		1.5 mm			
Colour		Black			
Pitch		3.50 mm			
Pol.	L1	(inch)	Qty.	Order No.	
2	3.50	0.138	265	1752984002	
3	7.00	0.276	265	1752994002	
4	10.50	0.413	265	1753004002	
5	14.00	0.551	265	1753014002	
6	17.50	0.689	265	1753024001	
7	21.00	0.827	265	1753034001	
8	24.50	0.965	265	1753044001	
9	28.00	1.102	265	1753054001	
10	31.50	1.240	265	1753064001	
11	35.00	1.378	265	1753074001	

Tape widths: 32, 44, 56, 72, 88

SL SMT 3.50/./180LF Box

with solder flange



Dimensioned drawing

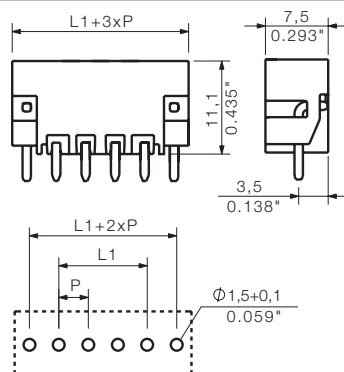

Ordering data

Solder pin length		1.5 mm		3.2 mm	
Colour		Black		Black	
Pitch		3.50 mm			
Pol.	L1	(inch)	Qty.	Order No.	Order No.
2	3.50	0.138	100	1804700000	1842540000
3	7.00	0.276	100	1804710000	1842550000
4	10.50	0.413	100	1804720000	1842560000
5	14.00	0.551	50	1804730000	1842570000
6	17.50	0.689	50	1804740000	1842580000
7	21.00	0.827	50	1804750000	1842590000
8	24.50	0.965	50	1804760000	1842600000
9	28.00	1.102	50	1804770000	1842610000
10	31.50	1.240	50	1804780000	1842620000
11	35.00	1.378	50	1804790000	1842630000
12	38.50	1.516	50	1804800000	1842640000
13	42.00	1.654	50	1804810000	1842650000
14	45.50	1.791	50	1804820000	1842660000
15	49.00	1.929	50	1804830000	1842670000
16	52.50	2.067	50	1804840000	1842680000
17	56.00	2.205	20	1804850000	1842690000
18	59.50	2.343	20	1804860000	1842700000
19	63.00	2.480	20	1804870000	1842710000
20	66.50	2.618	20	1804880000	1842720000
21	70.00	2.756	20	1804900000	1842730000
22	73.50	2.894	20	1804910000	1842740000
23	77.00	3.031	20	1804920000	1842750000
24	80.50	3.169	20	1804930000	1842760000

SL SMT 3.50/./180LF Tape

with solder flange



Dimensioned drawing

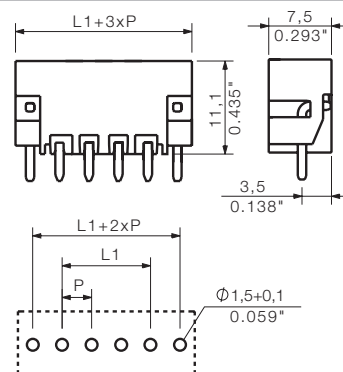

Ordering data

Solder pin length		1.5 mm			
Colour		Black			
Pitch		3.50 mm			
Pol.	L1	(inch)	Qty.	Order No.	
2	3.50	0.138	265	1805210000	
3	7.00	0.276	265	1805230000	
4	10.50	0.413	265	1805240000	
5	14.00	0.551	265	1805250000	
6	17.50	0.689	265	1805270000	
7	21.00	0.827	265	1805280000	
8	24.50	0.965	265	1805290000	
9	28.00	1.102	265	1805300000	

Tape widths: 32, 44, 56, 72, 88

SL 3.50/./90

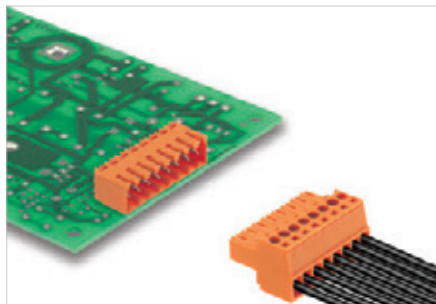

Angled male header (90° orientation) for wave soldering in 3.5 mm pitch. The male header is available in open, closed (G) and flange (F) versions. Packed in cardboard box.

Product data

IEC: 320 V / 17 A
UL: 300 V / 10 A

For additional articles and information, refer to catalog.weidmueller.com

Note:

- Additional colours on request
- Gold-plated contact surfaces on request
- Rated current related to rated cross-section & min. No. of poles.
- P on drawing = pitch
- Rated data refer only to the component itself. Clearance and creepage distances to other components are to be designed in accordance with the relevant application standards.

SL 3.50/./90

open side

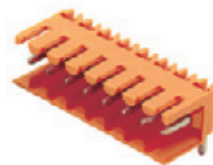

Dimensioned drawing

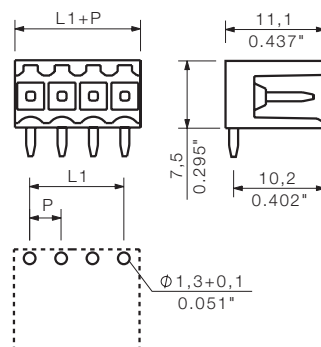

Technical data

In compliance with IEC 60664-1 / IEC 61984			
Clamping range, max.	mm ²		
Solid core H05(07) V-U	mm²		
Stranded H07 V-R			
Flexible H05(07) V-K	mm ²		
Flexible with ferrule	mm ²		
Ferrule with plastic collar	mm ²		
Stripping length	mm		
Screwdriver blade	mm		
According to norm			
Tightening torque range	Nm		
Rated current, max.	A	17	14.5
At ambient temperature		20°C	40°C
For conductor cross-section	mm ²		
Overvoltage category		III	III II
Pollution severity		3	2 2
Rated voltage	V	160	160 320
Rated impulse voltage	kV	2.5	2.5 2.5
UL / CUL (Use Group)		B	C D
Rated voltage	V	300	300
Rated current	A	10	10
AWG conductor	AWG		
CSA (Use Group)		B	C D
Rated voltage	V	300	300
Rated current	A	10	10
AWG conductor	AWG		
General data			
Type of insulation material		PBT	
UL 94 flammability rating		V-0	
Contact base material		CuSn	
Material of contact surface		tinned	
Pin dimensions = d	mm	1.2, Octagonal	
Solder eyelet Ø = D	mm	1.3	
Solder eyelet Ø tolerance	mm	+ 0,1	

Accessories

Note: Refer to the Accessories chapter for additional accessories.

Coding		Order No.
	BL SL 3.5 KO OR	1693430000
	BL SL 3.5 KO SW	1610100000
Interlock		
	BL/SL 3.5 VR OR	1669310000
	BL/SL 3.5 VR SW	1669300000
LED light guide		
	SL 3.5 FLA 1.5/1.75/8	1597630000
	SL 3.5 FLA 1.5/8	1597510000
	SL 3.5 FLA 2.3/1.75/8	1597640000
	SL 3.5 FLA 2.3/8	1597520000
	SL 3.5 FLA 4.0/1.75/8	1597650000
SL 3.5 FLA 4.0/8	1597530000	
Mounting screw		
	PTSC KA 2.2X4.5 WN1412	1610740000

Ordering data

Solder pin length		3.2 mm		
Colour		Orange		
Pitch 3.50 mm				
Pol.	L1	(inch)	Qty.	Order No.
2	3.50	0.138	100	1597210000
3	7.00	0.276	100	1597220000
4	10.50	0.413	100	1597230000
5	14.00	0.551	50	1597240000
6	17.50	0.689	50	1597250000
7	21.00	0.827	50	1597260000
8	24.50	0.965	50	1597270000
9	28.00	1.102	50	1597280000
10	31.50	1.240	50	1597290000
11	35.00	1.378	50	1597300000
12	38.50	1.516	50	1597310000
13	42.00	1.654	50	1597320000
14	45.50	1.791	50	1597330000
15	49.00	1.929	50	1597340000
16	52.50	2.067	50	1597350000
17	56.00	2.205	20	1618990000
18	59.50	2.343	20	1619000000
19	63.00	2.480	20	1619010000
20	66.50	2.618	20	1619020000
21	70.00	2.756	20	1619030000
22	73.50	2.894	20	1619040000
23	77.00	3.031	20	1619050000
24	80.50	3.169	20	1619060000

SL 3.50/./90G

closed side

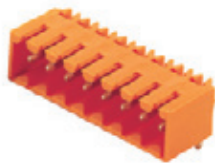

Dimensioned drawing

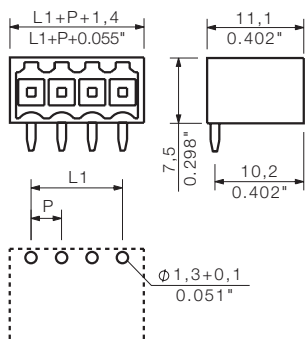

Ordering data

Solder pin length		3.2 mm			
Colour		Orange			
Pitch		3.50 mm			
Pol.	L1	(inch)	Qty.	Order No.	
2	3.50	0.138	100	1605070000	
3	7.00	0.276	100	1605080000	
4	10.50	0.413	100	1605090000	
5	14.00	0.551	50	1605100000	
6	17.50	0.689	50	1605110000	
7	21.00	0.827	50	1605120000	
8	24.50	0.965	50	1605130000	
9	28.00	1.102	50	1605140000	
10	31.50	1.240	50	1605150000	
11	35.00	1.378	50	1605160000	
12	38.50	1.516	50	1605170000	
13	42.00	1.654	50	1605180000	
14	45.50	1.791	50	1605190000	
15	49.00	1.929	50	1605200000	
16	52.50	2.067	50	1605210000	
17	56.00	2.205	20	1619380000	
18	59.50	2.343	20	1619390000	
19	63.00	2.480	20	1619400000	
20	66.50	2.618	20	1619410000	
21	70.00	2.756	20	1619420000	
22	73.50	2.894	20	1619430000	
23	77.00	3.031	20	1619440000	
24	80.50	3.169	20	1619450000	

SL 3.50/./90F

with screw flange



Dimensioned drawing

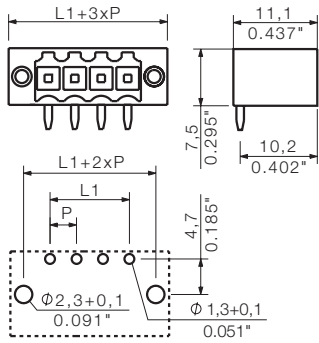

Ordering data

Solder pin length		3.2 mm			
Colour		Orange			
Pitch		3.50 mm			
Pol.	L1	(inch)	Qty.	Order No.	
2	3.50	0.138	100	1607040000	
3	7.00	0.276	100	1607050000	
4	10.50	0.413	100	1607060000	
5	14.00	0.551	50	1607070000	
6	17.50	0.689	50	1607080000	
7	21.00	0.827	50	1607090000	
8	24.50	0.965	50	1607100000	
9	28.00	1.102	50	1607110000	
10	31.50	1.240	50	1607120000	
11	35.00	1.378	50	1607130000	
12	38.50	1.516	50	1607140000	
13	42.00	1.654	50	1607150000	
14	45.50	1.791	50	1607160000	
15	49.00	1.929	50	1607170000	
16	52.50	2.067	50	1607180000	
17	56.00	2.205	20	1619770000	
18	59.50	2.343	20	1619780000	
19	63.00	2.480	20	1619790000	
20	66.50	2.618	20	1619800000	
21	70.00	2.756	20	1619810000	
22	73.50	2.894	20	1619820000	
23	77.00	3.031	20	1619830000	
24	80.50	3.169	20	1619840000	

SL 3.50../180

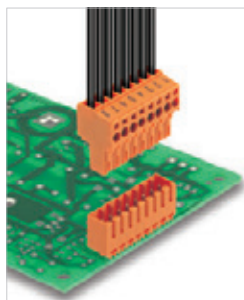

Straight male header (180° orientation) for wave soldering in 3.5 mm pitch. The male header is available in open, closed (G) and flange (F) versions. Packed in cardboard box.

Product data

IEC: 320 V / 17 A
UL: 300 V / 10 A

For additional articles and information, refer to catalog.weidmueller.com

Note:

- Additional colours on request
- Gold-plated contact surfaces on request
- Rated current related to rated cross-section & min. No. of poles.
- P on drawing = pitch
- Rated data refer only to the component itself. Clearance and creepage distances to other components are to be designed in accordance with the relevant application standards.

SL 3.50../180

open side

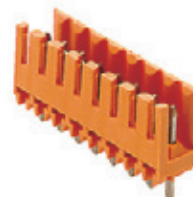

Dimensioned drawing

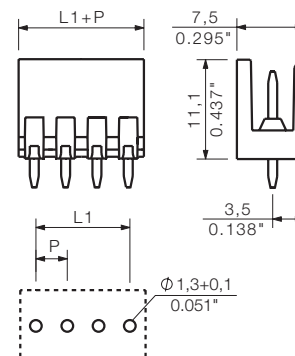

C

Technical data

In compliance with IEC 60664-1 / IEC 61984			
Clamping range, max.	mm ²		
Solid core H05(07) V-U	mm ²		
Stranded H07 V-R			
Flexible H05(07) V-K	mm ²		
Flexible with ferrule	mm ²		
Ferrule with plastic collar	mm ²		
Stripping length	mm		
Screwdriver blade	mm		
According to norm			
Tightening torque range	Nm		
Rated current, max.	A	17	14.5
At ambient temperature		20°C	40°C
For conductor cross-section	mm ²		
Overvoltage category		III	III II
Pollution severity		3	2 2
Rated voltage	V	160	160 320
Rated impulse voltage	kV	2.5	2.5 2.5
UL / CUL (Use Group)		B	C D
Rated voltage	V	300	300
Rated current	A	10	10
AWG conductor	AWG		
CSA (Use Group)		B	C D
Rated voltage	V	300	300
Rated current	A	10	10
AWG conductor	AWG		
General data			
Type of insulation material		PBT	
UL 94 flammability rating		V-0	
Contact base material		CuSn	
Material of contact surface		tinned	
Pin dimensions = d	mm	1.2, Octagonal	
Solder eyelet Ø = D	mm	1.3	
Solder eyelet Ø tolerance	mm	+ 0,1	

Accessories

Note: Refer to the Accessories chapter for additional accessories.			
Coding		Order No.	
	BL SL 3.5 KO OR	1693430000	
	BL SL 3.5 KO SW	1610100000	
Interlock			
	BL/SL 3.5 VR OR	1669310000	
	BL/SL 3.5 VR SW	1669300000	
Mounting screw			
	PTSC KA 2.2X4.5 WN1412	1610740000	

Ordering data

Solder pin length		3.2 mm		
Colour		Orange		
Pitch 3.50 mm				
Pol.	L1	(inch)	Qty.	Order No.
2	3.50	0.138	100	1604770000
3	7.00	0.276	100	1604780000
4	10.50	0.413	100	1604790000
5	14.00	0.551	50	1604800000
6	17.50	0.689	50	1604810000
7	21.00	0.827	50	1604820000
8	24.50	0.965	50	1604830000
9	28.00	1.102	50	1604840000
10	31.50	1.240	50	1604850000
11	35.00	1.378	50	1604860000
12	38.50	1.516	50	1604870000
13	42.00	1.654	50	1604880000
14	45.50	1.791	50	1604890000
15	49.00	1.929	50	1604900000
16	52.50	2.067	50	1604910000
17	56.00	2.205	20	1621400000
18	59.50	2.343	20	1621410000
19	63.00	2.480	20	1621420000
20	66.50	2.618	20	1621430000
21	70.00	2.756	20	1621440000
22	73.50	2.894	20	1621450000
23	77.00	3.031	20	1621460000
24	80.50	3.169	20	1621470000

SL 3.50/./180G

closed side

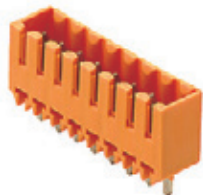

SL 3.50/./180F

with screw flange

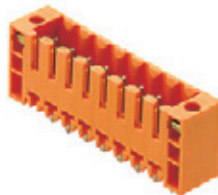

Dimensioned drawing

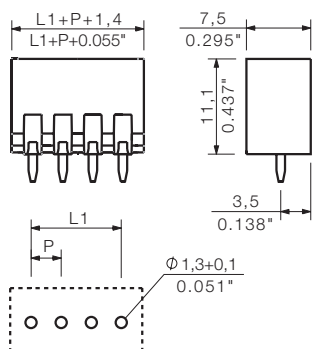

Dimensioned drawing

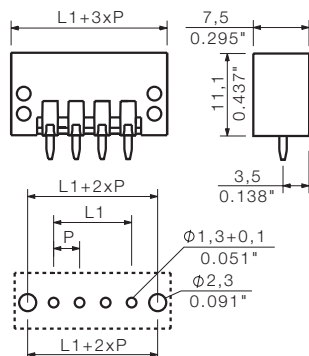

Ordering data

Solder pin length		3.2 mm	
Colour		Orange	
Pitch		3.50 mm	
Pol.	L1	(inch)	Qty. Order No.
2	3.50	0.138	100 1604470000
3	7.00	0.276	100 1604480000
4	10.50	0.413	100 1604490000
5	14.00	0.551	50 1604500000
6	17.50	0.689	50 1604510000
7	21.00	0.827	50 1604520000
8	24.50	0.965	50 1604530000
9	28.00	1.102	50 1604540000
10	31.50	1.240	50 1604550000
11	35.00	1.378	50 1604560000
12	38.50	1.516	50 1604570000
13	42.00	1.654	50 1604580000
14	45.50	1.791	50 1604590000
15	49.00	1.929	50 1604600000
16	52.50	2.067	50 1604610000
17	56.00	2.205	20 1621790000
18	59.50	2.343	20 1621800000
19	63.00	2.480	20 1621810000
20	66.50	2.618	20 1621820000
21	70.00	2.756	20 1621830000
22	73.50	2.894	20 1621840000
23	77.00	3.031	20 1621850000
24	80.50	3.169	20 1621860000

Ordering data

Solder pin length		3.2 mm	
Colour		Orange	
Pitch		3.50 mm	
Pol.	L1	(inch)	Qty. Order No.
2	3.50	0.138	100 1607500000
3	7.00	0.276	100 1607510000
4	10.50	0.413	100 1607520000
5	14.00	0.551	50 1607530000
6	17.50	0.689	50 1607540000
7	21.00	0.827	50 1607550000
8	24.50	0.965	50 1607560000
9	28.00	1.102	50 1607570000
10	31.50	1.240	50 1607580000
11	35.00	1.378	50 1607590000
12	38.50	1.516	50 1607600000
13	42.00	1.654	50 1607610000
14	45.50	1.791	50 1607620000
15	49.00	1.929	50 1607630000
16	52.50	2.067	50 1607640000
17	56.00	2.205	20 1622180000
18	59.50	2.343	20 1622190000
19	63.00	2.480	20 1622200000
20	66.50	2.618	20 1622210000
21	70.00	2.756	20 1622220000
22	73.50	2.894	20 1622230000
23	77.00	3.031	20 1622240000
24	80.50	3.169	20 1622250000

SL 3.50../135

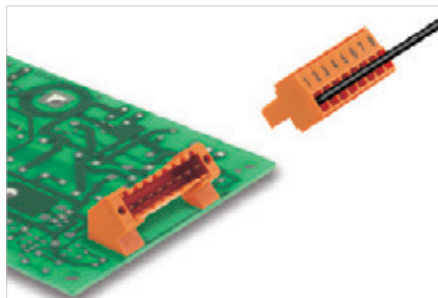

Angled male header (135° orientation) for wave soldering in 3.5 mm pitch. The male header is available in closed (G) and flange (F) versions.

Technical data

In compliance with IEC 60664-1 / IEC 61984			
Clamping range, max.	mm ²		
Solid core H05(07) V-U	mm ²		
Stranded H07 V-R			
Flexible H05(07) V-K	mm ²		
Flexible with ferrule	mm ²		
Ferrule with plastic collar	mm ²		
Stripping length	mm		
Screwdriver blade	mm		
According to norm			
Tightening torque range	Nm		
Rated current, max.	A	15	13
At ambient temperature		20°C	40°C
For conductor cross-section	mm ²		
Overtoltage category		III	III II
Pollution severity		3	2 2
Rated voltage	V	160	160 320
Rated impulse voltage	kV	2.5	2.5 2.5
UL / CUL (Use Group)		B	C D
Rated voltage	V	300	300
Rated current	A	10	10
AWG conductor	AWG		
CSA (Use Group)		B	C D
Rated voltage	V	300	300
Rated current	A	10	10
AWG conductor	AWG		
General data			
Type of insulation material		PBT	
UL 94 flammability rating		V-0	
Contact base material		CuSn	
Material of contact surface		tinned	
Pin dimensions = d	mm	1.2, Octagonal	
Solder eyelet Ø = D	mm	1.3	
Solder eyelet Ø tolerance	mm	+ 0,1	

Product data

IEC: 320 V / 15 A
UL: 300 V / 10 A

For additional articles and information, refer to catalog.weidmueller.com

Note:

- Additional colours on request
- Gold-plated contact surfaces on request
- Rated current related to rated cross-section & min. No. of poles.
- P on drawing = pitch
- Rated data refer only to the component itself. Clearance and creepage distances to other components are to be designed in accordance with the relevant application standards.

SL 3.50../135F

with screw flange



Dimensioned drawing

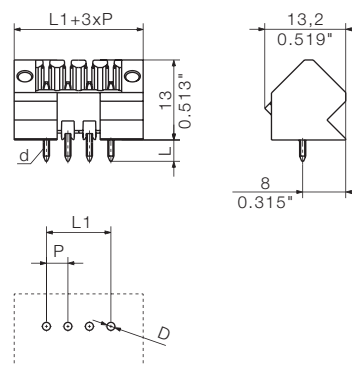

Accessories

Note: Refer to the Accessories chapter for additional accessories.

Coding		Order No.
	BL SL 3.5 KO OR	1693430000
	BL SL 3.5 KO SW	1610100000
Interlock		
	BL/SL 3.5 VR OR	1669310000
	BL/SL 3.5 VR SW	1669300000

Ordering data

Solder pin length		3.2 mm		
Colour		Orange		
Pitch	3.50 mm			
Pol.	L1	(inch)	Qty.	Order No.
2	3.50	0.138	100	1643330000
3	7.00	0.276	100	1643340000
4	10.50	0.413	100	1643350000
5	14.00	0.551	50	1643360000
6	17.50	0.689	50	1643370000
7	21.00	0.827	50	1643380000
8	24.50	0.965	50	1643390000
9	28.00	1.102	50	1643400000
10	31.50	1.240	50	1643410000
11	35.00	1.378	50	1643420000
12	38.50	1.516	50	1643430000
13	42.00	1.654	50	1643440000
14	45.50	1.791	50	1643450000
15	49.00	1.929	50	1643460000
16	52.50	2.067	50	1643470000
17	56.00	2.205	20	1643480000
18	59.50	2.343	20	1643490000
19	63.00	2.480	20	1643500000
20	66.50	2.618	20	1643510000
21	70.00	2.756	20	1643520000
22	73.50	2.894	20	1643530000
23	77.00	3.031	20	1643540000
24	80.50	3.169	20	1643550000

SL-THR 3.50/././135

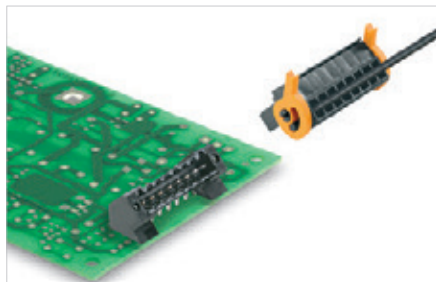

High-temperature-resistant, 135° angled, male header for all common soldering methods in 3.5 mm pitch. 3.2 mm solder pin suitable for reflow and wave soldering. The pin headers provide space for labelling and can be coded.

Technical data

In compliance with IEC 60664-1 / IEC 61984			
Clamping range, max.	mm ²		
Solid core H05(07) V-U	mm²		
Stranded H07 V-R			
Flexible H05(07) V-K	mm ²		
Flexible with ferrule	mm ²		
Ferrule with plastic collar	mm ²		
Stripping length	mm		
Screwdriver blade	mm		
According to norm			
Tightening torque range	Nm		
Rated current, max.	A	15	13
At ambient temperature		20°C	40°C
For conductor cross-section	mm ²		
Overtoltage category		III	III II
Pollution severity		3	2 2
Rated voltage	V	160	160 320
Rated impulse voltage	kV	2.5	2.5 2.5
UL / CUL (Use Group)	B C D		
Rated voltage	V	300	300
Rated current	A	10	10
AWG conductor	AWG		
CSA (Use Group)	B C D		
Rated voltage	V	300	300
Rated current	A	10	10
AWG conductor	AWG		
General data			
Type of insulation material		LCP GF	
UL 94 flammability rating		V-0	
Contact base material		CuSn	
Material of contact surface		tinned	
Pin dimensions = d	mm	1.2, Octagonal	
Solder eyelet Ø = D	mm	1.3	
Solder eyelet Ø tolerance	mm	+ 0,1	

Product data

IEC: 320 V / 15 A
UL: 300 V / 10 A

For additional articles and information, refer to catalog.weidmueller.com

Note:

- Gold-plated contact surfaces on request
- Rated current related to rated cross-section & min. No. of poles.
- P on drawing = pitch
- Rated data refer only to the component itself. Clearance and creepage distances to other components are to be designed in accordance with the relevant application standards.

SL-THR 3.50/././135F

with screw flange



Dimensioned drawing

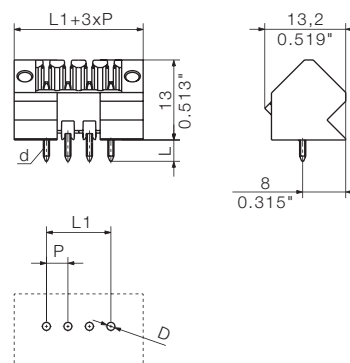

Accessories

Note: Refer to the Accessories chapter for additional accessories.

Coding		Order No.
	BL SL 3.5 KO OR	1693430000
	BL SL 3.5 KO SW	1610100000
Interlock		
	BL/SL 3.5 VR OR	1669310000
	BL/SL 3.5 VR SW	1669300000

Ordering data

Solder pin length		3.2 mm		
Colour		Black		
Pitch 3.50 mm				
Pol.	L1	(inch)	Qty.	Order No.
2	3.50	0.138	100	1003510000
3	7.00	0.276	100	1003520000
4	10.50	0.413	100	1003530000
5	14.00	0.551	50	1003540000
6	17.50	0.689	50	1003550000
7	21.00	0.827	50	1003560000
8	24.50	0.965	50	1003570000
9	28.00	1.102	50	1003580000
10	31.50	1.240	50	1003590000
11	35.00	1.378	50	1003600000
12	38.50	1.516	50	1003620000
13	42.00	1.654	50	1003630000
14	45.50	1.791	50	1003640000
15	49.00	1.929	50	1003650000
16	52.50	2.067	50	1003660000
17	56.00	2.205	20	1003670000
18	59.50	2.343	20	1003680000
19	63.00	2.480	20	1003690000
20	66.50	2.618	20	1003700000
21	70.00	2.756	20	1003710000
22	73.50	2.894	20	1003720000
23	77.00	3.031	20	1003730000
24	80.50	3.169	20	1003740000

SLD 3.50/./90

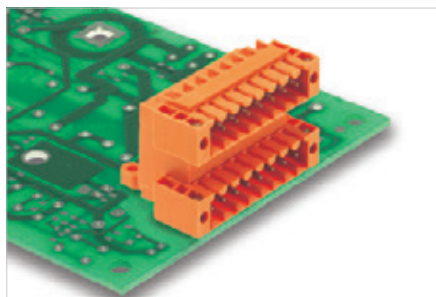

Double-level, angled male header (90° orientation) for wave soldering in 3.5 mm pitch. The male header is available in open, closed (G) and flange (F) versions.

Technical data

In compliance with IEC 60664-1 / IEC 61984			
Clamping range, max.	mm ²		
Solid core H05(07) V-U	mm ²		
Stranded H07 V-R			
Flexible H05(07) V-K	mm ²		
Flexible with ferrule	mm ²		
Ferrule with plastic collar	mm ²		
Stripping length	mm		
Screwdriver blade	mm		
According to norm			
Tightening torque range	Nm		
Rated current, max.	A	10.5	9
At ambient temperature		20°C	40°C
For conductor cross-section	mm ²		
Overtoltage category		III	III II
Pollution severity		3	2 2
Rated voltage	V	125	160 200
Rated impulse voltage	kV	2.5	2.5 2.5
UL / CUL (Use Group)		B	C D
Rated voltage	V	300	300
Rated current	A	8	8
AWG conductor	AWG		
CSA (Use Group)		B	C D
Rated voltage	V	300	300
Rated current	A	8	8
AWG conductor	AWG		
General data			
Type of insulation material		PBT	
UL 94 flammability rating		V-0	
Contact base material		CuSn	
Material of contact surface		tinned	
Pin dimensions = d	mm	1.2, Octagonal	
Solder eyelet Ø = D	mm	1.3	
Solder eyelet Ø tolerance	mm	+ 0,1	

Product data

IEC: 200 V / 10.5 A
UL: 300 V / 8 A

For additional articles and information, refer to catalog.weidmueller.com

Note:

- Additional colours on request
- Gold-plated contact surfaces on request
- Rated current related to rated cross-section & min. No. of poles.
- P on drawing = pitch
- Rated data refer only to the component itself. Clearance and creepage distances to other components are to be designed in accordance with the relevant application standards.

SLD 3.50/./90G

closed side

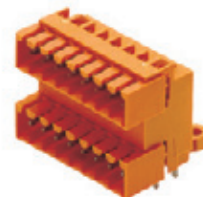

Dimensioned drawing

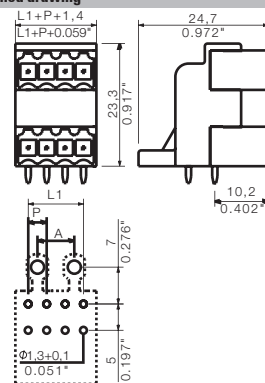

Accessories

Note: Refer to the Accessories chapter for additional accessories.

Coding	Order No.
BL SL 3.5 KO OR	1693430000
BL SL 3.5 KO SW	1610100000

Ordering data

Solder pin length		3.2 mm		
Colour	Orange			
Pitch	3.50 mm			
Pol.	L1	(inch)	Qty.	Order No.
4	3.50	0.138	50	1633580000
6	7.00	0.276	50	1633590000
8	10.50	0.413	50	1633600000
10	14.00	0.551	50	1633610000
12	17.50	0.689	50	1633620000
14	21.00	0.827	20	1633630000
16	24.50	0.965	20	1633640000
18	28.00	1.102	20	1633650000
20	31.50	1.240	20	1633660000
22	35.00	1.378	10	1633670000
24	38.50	1.516	10	1633680000
26	42.00	1.654	10	1633690000
28	45.50	1.791	10	1633700000
30	49.00	1.929	10	1633710000
32	52.50	2.067	10	1633720000
34	56.00	2.205	10	1633730000
36	59.50	2.343	10	1633740000
38	63.00	2.480	10	1633750000
40	66.50	2.618	10	1633760000
42	70.00	2.756	10	1633770000
44	73.50	2.894	10	1633780000
46	77.00	3.031	10	1633790000
48	80.50	3.169	10	1633800000

SLD 3.50/./90F

with screw flange



Dimensioned drawing

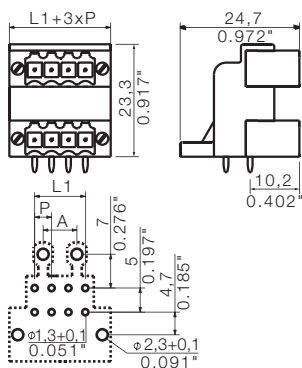

Ordering data

Solder pin length		3.2 mm		
Colour		Orange		
Pitch		3.50 mm		
Pol.	L1	(inch)	Qty.	Order No.
4	3.50	0.138	50	1633810000
6	7.00	0.276	50	1633820000
8	10.50	0.413	50	1633830000
10	14.00	0.551	50	1633840000
12	17.50	0.689	50	1633850000
14	21.00	0.827	20	1633860000
16	24.50	0.965	20	1633870000
18	28.00	1.102	20	1633880000
20	31.50	1.240	20	1633890000
22	35.00	1.378	10	1633900000
24	38.50	1.516	10	1633910000
26	42.00	1.654	10	1633920000
28	45.50	1.791	10	1633930000
30	49.00	1.929	10	1633940000
32	52.50	2.067	10	1633950000
34	56.00	2.205	10	1633960000
36	59.50	2.343	10	1633970000
38	63.00	2.480	10	1633980000
40	66.50	2.618	10	1633990000
42	70.00	2.756	10	1634000000
44	73.50	2.894	10	1634010000
46	77.00	3.031	10	1634020000
48	80.50	3.169	10	1634030000

SLD 3.50V/./90

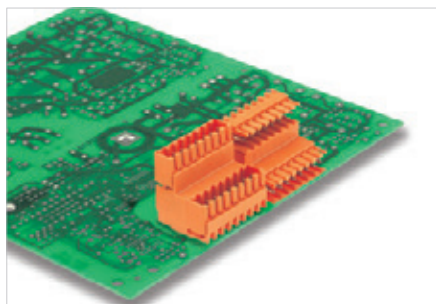

Double-level, staggered male header with angled 90° wire outlet for wave soldering in 3.5 mm pitch. The male header is available in open, closed (G) and flange (F) versions.

Technical data

In compliance with IEC 60664-1 / IEC 61984			
Clamping range, max.	mm ²		
Solid core H05(07) V-U	mm²		
Stranded H07 V-R			
Flexible H05(07) V-K	mm ²		
Flexible with ferrule	mm ²		
Ferrule with plastic collar	mm ²		
Stripping length	mm		
Screwdriver blade	mm		
According to norm			
Tightening torque range	Nm		
Rated current, max.	A	10.5	9
At ambient temperature		20°C	40°C
For conductor cross-section	mm ²		
Overtoltage category		III	III II
Pollution severity		3	2 2
Rated voltage	V	125	160 200
Rated impulse voltage	kV	2.5	2.5 2.5
UL / CUL (Use Group)	B C D		
Rated voltage	V	300	300
Rated current	A	8	8
AWG conductor	AWG		
CSA (Use Group)	B C D		
Rated voltage	V	300	300
Rated current	A	8	8
AWG conductor	AWG		
General data			
Type of insulation material		PBT	
UL 94 flammability rating		V-0	
Contact base material		CuSn	
Material of contact surface		tinned	
Pin dimensions = d	mm	1.2, Octagonal	
Solder eyelet Ø = D	mm	1.3	
Solder eyelet Ø tolerance	mm	+ 0,1	

Product data

IEC: 200 V / 10.5 A
UL: 300 V / 8 A

For additional articles and information, refer to catalog.weidmueller.com

Note:

- Additional colours on request
- Rated current related to rated cross-section & min. No. of poles.
- Spacing between rows: see hole layout
- P on drawing = pitch
- Rated data refer only to the component itself. Clearance and creepage distances to other components are to be designed in accordance with the relevant application standards.

SLD 3.50V/./90G

closed side

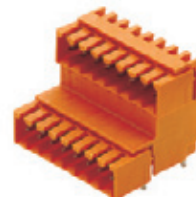

Dimensioned drawing

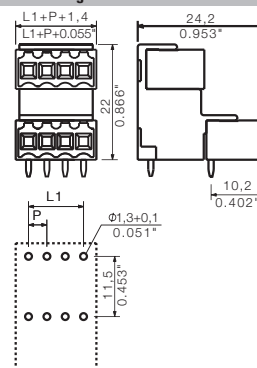

Accessories

Note: Refer to the Accessories chapter for additional accessories.

Coding		Order No.
	BL SL 3.5 KO OR	1693430000
	BL SL 3.5 KO SW	1610100000

Ordering data

Solder pin length		3.2 mm		
Colour		Orange		
Pitch		3.50 mm		
Pol.	L1	(inch)	Qty.	Order No.
4	3.50	0.138	50	1642240000
6	7.00	0.276	50	1890600000
8	10.50	0.413	50	1642250000
10	14.00	0.551	50	1866770000
12	17.50	0.689	50	1642260000
14	21.00	0.827	20	1890610000
16	24.50	0.965	20	1642270000
18	28.00	1.102	20	1890620000
20	31.50	1.240	20	1642280000
22	35.00	1.378	10	1669650000
24	38.50	1.516	10	1642290000
26	42.00	1.654	10	1890630000
28	45.50	1.791	10	1642300000
30	49.00	1.929	10	1890640000
32	52.50	2.067	10	1642310000
34	56.00	2.205	10	1890650000
36	59.50	2.343	10	1642320000
38	63.00	2.480	10	1890660000
40	66.50	2.618	10	1642330000
42	70.00	2.756	10	1890670000
44	73.50	2.894	10	1642340000
46	77.00	3.031	10	1890680000
48	80.50	3.169	10	1642350000

SLD 3.50V../90F

with screw flange



Dimensioned drawing

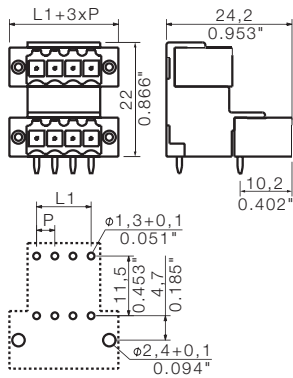

Ordering data

Solder pin length		3.2 mm		
Colour		Orange		
Pitch		3.50 mm		
Pol.	L1	(inch)	Qty.	Order No.
4	3.50	0.138	50	1642370000
6	7.00	0.276	50	1890790000
8	10.50	0.413	50	1642380000
10	14.00	0.551	50	1890800000
12	17.50	0.689	50	1642390000
14	21.00	0.827	20	1890810000
16	24.50	0.965	20	1642400000
18	28.00	1.102	20	1890820000
20	31.50	1.240	20	1642410000
22	35.00	1.378	10	1669660000
24	38.50	1.516	10	1642420000
26	42.00	1.654	10	1890830000
28	45.50	1.791	10	1642430000
30	49.00	1.929	10	1890840000
32	52.50	2.067	10	1642440000
34	56.00	2.205	10	1890850000
36	59.50	2.343	10	1642450000
38	63.00	2.480	10	1890860000
40	66.50	2.618	10	1642460000
42	70.00	2.756	10	1890870000
44	73.50	2.894	10	1642470000
46	77.00	3.031	10	1890880000
48	80.50	3.169	10	1642480000

SLD 3.50V../180

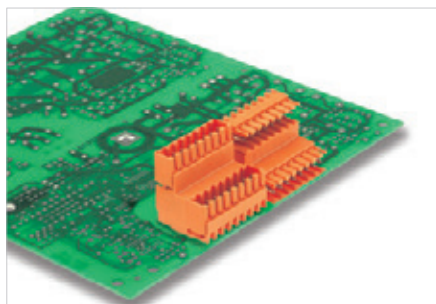

Double-level, staggered male header with straight 180° wire outlet for wave soldering in 3.5 mm pitch. The male header is available in closed (G) and flange (F) versions.

Product data

IEC: 200 V / 10.5 A
UL: 300 V / 8 A

For additional articles and information, refer to catalog.weidmueller.com

Note:

- Additional colours on request
- Rated current related to rated cross-section & min. No. of poles.
- Spacing between rows: see hole layout
- P on drawing = pitch
- Rated data refer only to the component itself. Clearance and creepage distances to other components are to be designed in accordance with the relevant application standards.

SLD 3.50V../180G

closed side



Dimensioned drawing

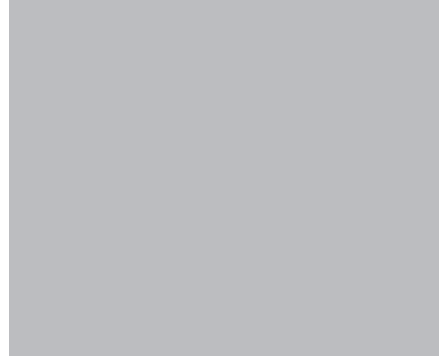
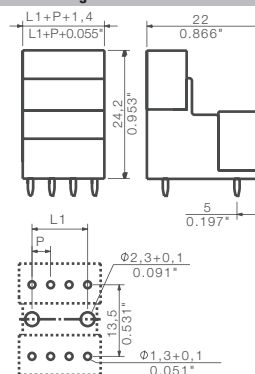

Technical data

In compliance with IEC 60664-1 / IEC 61984			
Clamping range, max.	mm ²		
Solid core H05(07) V-U	mm ²		
Stranded H07 V-R			
Flexible H05(07) V-K	mm ²		
Flexible with ferrule	mm ²		
Ferrule with plastic collar	mm ²		
Stripping length	mm		
Screwdriver blade	mm		
According to norm			
Tightening torque range	Nm		
Rated current, max.	A	10.5	9
At ambient temperature		20°C	40°C
For conductor cross-section	mm ²		
Overtoltage category		III	III II
Pollution severity		3	2 2
Rated voltage	V	125 160 200	
Rated impulse voltage	kV	2.5 2.5 2.5	
UL / CUL (Use Group)		B C D	D
Rated voltage	V	300	300
Rated current	A	8	8
AWG conductor	AWG		-
CSA (Use Group)		B C D	D
Rated voltage	V	300	300
Rated current	A	8	8
AWG conductor	AWG		-
General data			
Type of insulation material		PBT	
UL 94 flammability rating		V-0	
Contact base material		CuSn	
Material of contact surface		tinned	
Pin dimensions = d	mm	1.2, Octagonal	
Solder eyelet Ø = D	mm	1.3	
Solder eyelet Ø tolerance	mm	+ 0,1	

Accessories

Note: Refer to the Accessories chapter for additional accessories.

Coding		Order No.
	BL SL 3.5 KO OR	1693430000
	BL SL 3.5 KO SW	1610100000

Ordering data

Solder pin length		3.2 mm		
Colour		Orange		
Pitch		3.50 mm		
Pol.	L1	(inch)	Qty.	Order No.
4	3.50	0.138	50	1641110000
6	7.00	0.276	50	1891190000
8	10.50	0.413	50	1641120000
10	14.00	0.551	50	1891200000
12	17.50	0.689	50	1641130000
16	24.50	0.965	20	1641140000
20	31.50	1.240	20	1641150000
24	38.50	1.516	10	1641160000
28	45.50	1.791	10	1641170000
32	52.50	2.067	10	1641180000
34	56.00	2.205	10	1891260000
36	59.50	2.343	10	1641190000
38	63.00	2.480	10	1891270000
40	66.50	2.618	10	1641200000
42	70.00	2.756	10	1891280000
44	73.50	2.894	10	1641210000
46	77.00	3.031	10	1891290000
48	80.50	3.169	10	1641220000

SLD 3.50V../180F

with screw flange



Dimensioned drawing

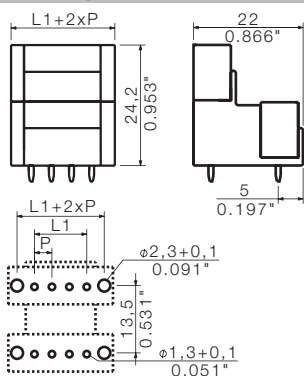

Ordering data

Solder pin length		3.2 mm		
Colour		Orange		
Pitch		3.50 mm		
Pol.	L1	(inch)	Qty.	Order No.
4	3.50	0.138	50	1641240000
6	7.00	0.276	50	1891060000
8	10.50	0.413	50	1641250000
10	14.00	0.551	50	1891070000
12	17.50	0.689	50	1641260000
14	21.00	0.827	20	1891080000
16	24.50	0.965	20	1641270000
18	28.00	1.102	20	1891090000
20	31.50	1.240	20	1641280000
22	35.00	1.378	20	1891100000
24	38.50	1.516	10	1641290000
26	42.00	1.654	10	1891110000
28	45.50	1.791	10	1641300000
30	49.00	1.929	10	1891120000
32	52.50	2.067	10	1641310000
34	56.00	2.205	10	1891130000
36	59.50	2.343	10	1641320000
38	63.00	2.480	10	1891140000
40	66.50	2.618	10	1641330000
42	70.00	2.756	10	1891150000
44	73.50	2.894	10	1641340000
46	77.00	3.031	10	1891160000
48	80.50	3.169	10	1641350000

BL 3.50/.. /180

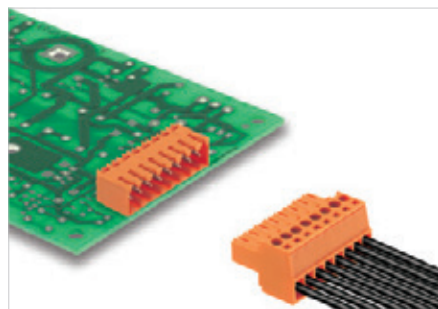

Female plug with clamping-yoke screw system for connecting wires with straight outlet direction in 3.5 mm pitch. Available with a screw flange (F), release lever (LH) or lock and release lever (LR). They include space for labelling and can be coded.

Technical data

In compliance with IEC 60664-1 / IEC 61984			
Clamping range, max.	mm ²	0.08...1.5	
Solid core H05(07) V-U	mm ²	0.2...1.5	
Stranded H07 V-R			
Flexible H05(07) V-K	mm ²	0.2...1.5	
Flexible with ferrule	mm ²	0.2...1.5	
Ferrule with plastic collar	mm ²	0.2...1.5	
Stripping length	mm	6	
Screwdriver blade	mm	0.4 x 2.5	
According to norm		DIN 5264	
Tightening torque range	Nm	0.2...0.25	
Rated current, max.	A	17	14.5
At ambient temperature	20°C	40°C	
For conductor cross-section	mm ²	1.5	
Overtolerance category		III	III II
Pollution severity		3	2 2
Rated voltage	V	160	160 320
Rated impulse voltage	kV	2.5	2.5 2.5
UL / CUL (Use Group)		B	C D
Rated voltage	V	300	300
Rated current	A	10	10
AWG conductor	AWG	28-14	
CSA (Use Group)		B	C D
Rated voltage	V	300	300
Rated current	A	10	10
AWG conductor	AWG	28-14	
General data			
Type of insulation material		PBT	
UL 94 flammability rating		V-0	
Contact base material		Copper alloy	
Material of contact surface		tinned	
Pin dimensions = d	mm		
Solder eyelet Ø = D	mm		
Solder eyelet Ø tolerance	mm		

Product data

IEC: 320 V / 17 A / 0.2 - 1.5 mm²
UL: 300 V / 10 A / AWG 28 - 14

For additional articles and information, refer to catalog.weidmuller.com

- Note:**
- Additional colours on request
 - Gold-plated contact surfaces on request
 - Rated current related to rated cross-section & min. No. of poles.
 - Max. outer diameter of the conductor: 2.9 mm
 - Wire end ferrule without plastic collar to DIN 46228/1
 - Wire end ferrule with plastic collar to DIN 46228/4
 - P on drawing = pitch
 - Rated data refer only to the component itself. Clearance and creepage distances to other components are to be designed in accordance with the relevant application standards.

BL 3.50/.. /180

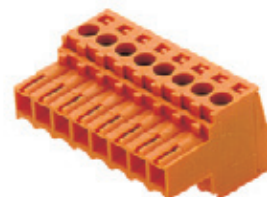

Dimensioned drawing

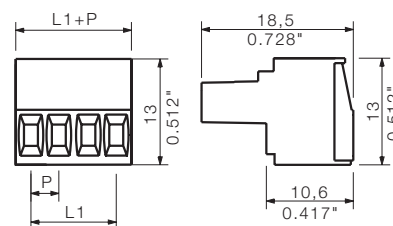

Accessories

Note: Refer to the Accessories chapter for additional accessories.

Coding		Order No.
	BL SL 3.5 KO OR	1693430000
	BL SL 3.5 KO SW	1610100000
Hood		
	BL 3.5 AH 10 SW	1745650000
	BL 3.5 AH 11 SW	1745660000
	BL 3.5 AH 12 SW	1745670000
	BL 3.5 AH 13 SW	1745680000
	BL 3.5 AH 14 SW	1745690000
	BL 3.5 AH 15 SW	1745700000
	BL 3.5 AH 16 SW	1745710000
	BL 3.5 AH 3 SW	1745580000
	BL 3.5 AH 4 SW	1745590000
Strain relief	BL 3.5 AH 5 SW	1745600000
	BL 3.5 AH 6 SW	1745610000
	BL 3.5 AH 7 SW	1745620000
	BL 3.5 AH 8 SW	1745630000
	BL 3.5 AH 9 SW	1745640000
Interlock	BL 3.5 ZE 3 OR	1629680000
	BL 3.5 ZE 3 SW	1627820000
	BL 3.5 ZE 8 OR	1629690000
	BL 3.5 ZE 8 SW	1627830000
Screwdriver	BL/SL 3.5 VR OR	1669310000
	BL/SL 3.5 VR SW	1669300000
	SDIS 0.4X2.5X75	9008370000
	SDS 0.4X2.5X75	9009030000

Ordering data

Solder pin length					
Colour	Orange		Black		
Pitch 3.50 mm					
Pol.	L1	(inch)	Qty.	Order No.	Order No.
2	3.50	0.138	100	1597360000	1615670000
3	7.00	0.276	100	1597370000	1615680000
4	10.50	0.413	100	1597380000	1615690000
5	14.00	0.551	50	1597390000	1614090000
6	17.50	0.689	50	1597400000	1610180000
7	21.00	0.827	50	1597410000	1610190000
8	24.50	0.965	50	1597420000	1615700000
9	28.00	1.102	50	1597430000	1615710000
10	31.50	1.240	50	1597440000	1610200000
11	35.00	1.378	50	1597450000	1615720000
12	38.50	1.516	50	1597460000	1615730000
13	42.00	1.654	50	1597470000	1615740000
14	45.50	1.791	50	1597480000	1615750000
15	49.00	1.929	50	1597490000	1615760000
16	52.50	2.067	50	1597500000	1615770000
17	56.00	2.205	20	1620290000	1620370000
18	59.50	2.343	20	1620300000	1620380000
19	63.00	2.480	20	1620310000	1620390000
20	66.50	2.618	20	1620320000	1620400000
21	70.00	2.756	20	1620330000	1620410000
22	73.50	2.894	20	1620340000	1620420000
23	77.00	3.031	20	1620350000	1620430000
24	80.50	3.169	20	1620360000	1620440000

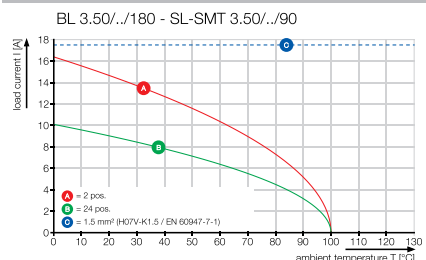

BL 3.50../180F

with screw flange



Dimensioned drawing

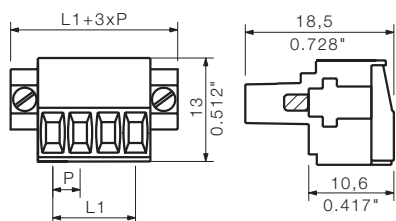

Ordering data

Solder pin length					
Colour		Orange	Black		
Pitch	3.50 mm				
Pol.	L1	(inch)	Qty.	Order No.	Order No.
2	3.50	0.138	100	1606640000	1615780000
3	7.00	0.276	100	1606650000	1615790000
4	10.50	0.413	100	1606660000	1615800000
5	14.00	0.551	50	1606670000	1615810000
6	17.50	0.689	50	1606680000	1615820000
7	21.00	0.827	50	1606690000	1615830000
8	24.50	0.965	50	1606700000	1615840000
9	28.00	1.102	50	1606710000	1615850000
10	31.50	1.240	50	1606720000	1615860000
11	35.00	1.378	50	1606730000	1615870000
12	38.50	1.516	50	1606740000	1615880000
13	42.00	1.654	50	1606750000	1615890000
14	45.50	1.791	50	1606760000	1615900000
15	49.00	1.929	50	1606770000	1615910000
16	52.50	2.067	50	1606780000	1615920000
17	56.00	2.205	20	1620760000	1620840000
18	59.50	2.343	20	1620770000	1620850000
19	63.00	2.480	20	1620780000	1620860000
20	66.50	2.618	20	1620790000	1620870000
21	70.00	2.756	20	1620800000	1620880000
22	73.50	2.894	20	1620810000	1620890000
23	77.00	3.031	20	1620820000	1620900000
24	80.50	3.169	20	1620830000	1620910000

BL 3.50../180LH

with release lever



Dimensioned drawing

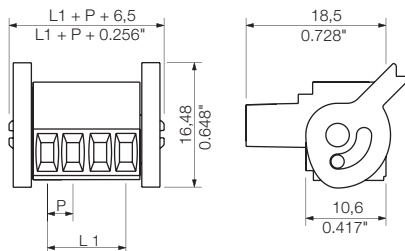

Ordering data

Solder pin length					
Colour		Orange	Black		
Pitch	3.50 mm				
Pol.	L1	(inch)	Qty.	Order No.	Order No.
2	3.50	0.138	100	1687650000	1687880000
3	7.00	0.276	100	1687660000	1687890000
4	10.50	0.413	100	1687670000	1687900000
5	14.00	0.551	50	1687680000	1687910000
6	17.50	0.689	50	1687690000	1687920000
7	21.00	0.827	50	1687700000	1687930000
8	24.50	0.965	50	1687710000	1687940000
9	28.00	1.102	50	1687720000	1687950000
10	31.50	1.240	50	1687730000	1687960000
11	35.00	1.378	50	1687740000	1687970000
12	38.50	1.516	50	1687750000	1687980000
13	42.00	1.654	50	1687760000	1687990000
14	45.50	1.791	50	1687770000	1688000000
15	49.00	1.929	50	1687780000	1688010000
16	52.50	2.067	50	1687790000	1688020000
17	56.00	2.205	20	1687800000	1688030000
18	59.50	2.343	20	1687810000	1688040000
19	63.00	2.480	20	1687820000	1688050000
20	66.50	2.618	20	1687830000	1688060000
21	70.00	2.756	20	1687840000	1688070000
22	73.50	2.894	20	1687850000	1688080000
23	77.00	3.031	20	1687860000	1688090000
24	80.50	3.169	20	1687870000	1688100000

BL 3.50../180LR

with release latch



Dimensioned drawing

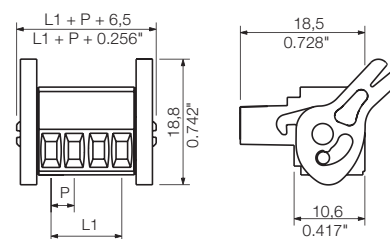

Ordering data

Solder pin length					
Colour		Orange			
Pitch	3.50 mm				
Pol.	L1	(inch)	Qty.	Order No.	
2	3.50	0.138	100	1379600000	
3	7.00	0.276	100	1134310000	
4	10.50	0.413	100	1134320000	
5	14.00	0.551	50	1134330000	
6	17.50	0.689	50	1134340000	
7	21.00	0.827	50	1134350000	
8	24.50	0.965	50	1134360000	
9	28.00	1.102	50	1134370000	
10	31.50	1.240	50	1134380000	
11	35.00	1.378	50	1134390000	
12	38.50	1.516	50	1134400000	
13	42.00	1.654	50	1134410000	
14	45.50	1.791	50	1134420000	
15	49.00	1.929	50	1134430000	
16	52.50	2.067	50	1134440000	

Compatible with SL-SMT 3.50../90RF

Additional deratings curves

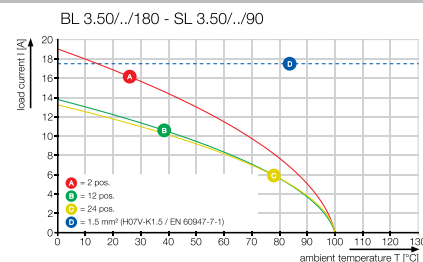
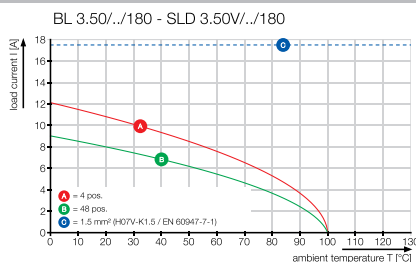
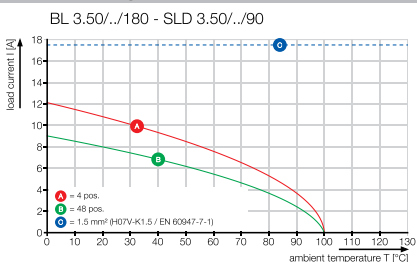

Connectors in 3.50 mm pitch
Series BL/SL 3.50

BL 3.50/./90 & 270

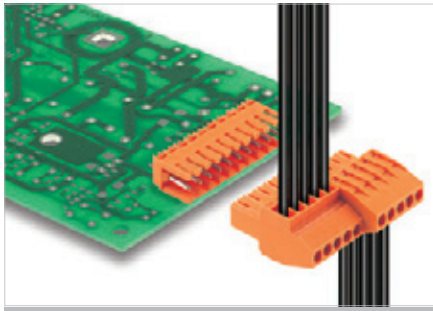

Female plug with clamping-yoke screw system for connecting wires with 90° and 270° angled orientation in 3.5 mm pitch. The female plugs are also available with a flange (F). They include space for labelling and can be coded.

Product data

IEC: 320 V / 12 A / 0.2 - 1.5 mm²
UL: 300 V / 8 A / AWG 28 - 14

For additional articles and information, refer to catalog.weidmueller.com

Note:

- Additional colours on request
- Gold-plated contact surfaces on request
- Rated current related to rated cross-section & min. No. of poles.
- Max. outer diameter of the conductor: 2.9 mm
- Wire end ferrule without plastic collar to DIN 46228/1
- Wire end ferrule with plastic collar to DIN 46228/4
- P on drawing = pitch
- Rated data refer only to the component itself. Clearance and creepage distances to other components are to be designed in accordance with the relevant application standards.

BL 3.50/./90



Dimensioned drawing

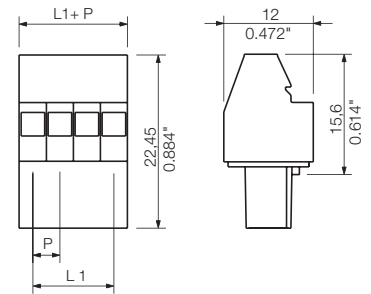



Technical data

In compliance with IEC 60664-1 / IEC 61984		
Clamping range, max.	mm ²	0.08...1.5
Solid core H05(07) V-U	mm ²	0.2...1.5
Stranded H07 V-R		
Flexible H05(07) V-K	mm ²	0.2...1.5
Flexible with ferrule	mm ²	0.2...1.5
Ferrule with plastic collar	mm ²	0.2...1.5
Stripping length	mm	6
Screwdriver blade	mm	0.4 x 2.5
According to norm		DIN 5264
Tightening torque range	Nm	0.2...0.25
Rated current, max.	A	12 10
At ambient temperature	20°C	40°C
For conductor cross-section	mm ²	1.5
Overvoltage category		III III II
Pollution severity		3 2 2
Rated voltage	V	160 160 320
Rated impulse voltage	kV	2.5 2.5 2.5
UL / CUL (Use Group)		B C D
Rated voltage	V	300 300
Rated current	A	8 8
AWG conductor	AWG	28-14
CSA (Use Group)		B C D
Rated voltage	V	300 300
Rated current	A	10 10
AWG conductor	AWG	28-14
General data		
Type of insulation material		PBT
UL 94 flammability rating		V-0
Contact base material		Copper alloy
Material of contact surface		tinned
Pin dimensions = d	mm	
Solder eyelet Ø = D	mm	
Solder eyelet Ø tolerance	mm	

Accessories

Note: Refer to the Accessories chapter for additional accessories.

Coding		Order No.
	BL SL 3.5 KO OR	1693430000
	BL SL 3.5 KO SW	1610100000
Screwdriver		
	SDIS 0.4X2.5X75	9008370000
	SDS 0.4X2.5X75	9009030000

Ordering data

Solder pin length						
Colour	Orange		Black			
Pitch 3.50 mm						
Pol.	L1 (inch)	Qty.	Order No.	Order No.		
2	3.50	0.138	100	1638550000	1638780000	
3	7.00	0.276	100	1638560000	1638790000	
4	10.50	0.413	100	1638570000	1638800000	
5	14.00	0.551	50	1638580000	1638810000	
6	17.50	0.689	50	1638590000	1638820000	
7	21.00	0.827	50	1638600000	1638830000	
8	24.50	0.965	50	1638610000	1638840000	
9	28.00	1.102	50	1638620000	1638850000	
10	31.50	1.240	50	1638630000	1638860000	
11	35.00	1.378	50	1638640000	1638870000	
12	38.50	1.516	50	1638650000	1638880000	
13	42.00	1.654	50	1638660000	1638890000	
14	45.50	1.791	50	1638670000	1638900000	
15	49.00	1.929	50	1638680000	1638910000	
16	52.50	2.067	50	1638690000	1638920000	
17	56.00	2.205	20	1638700000	1638930000	
18	59.50	2.343	20	1638710000	1638940000	
19	63.00	2.480	20	1638720000	1638950000	
20	66.50	2.618	20	1638730000	1638960000	
21	70.00	2.756	20	1638740000	1638970000	
22	73.50	2.894	20	1638750000	1638980000	
23	77.00	3.031	20	1638760000	1638990000	
24	80.50	3.169	20	1638770000	1639000000	

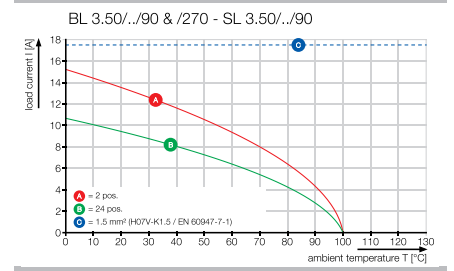

BL 3.50/./90F

with screw flange



Dimensioned drawing

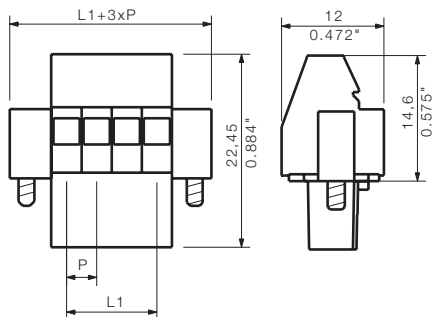

Ordering data

Solder pin length					
Colour	Orange		Black		
Pitch	3.50 mm				
Pol.	L1	(inch)	Qty.	Order No.	Order No.
2	3.50	0.138	100	1639010000	1639240000
3	7.00	0.276	100	1639020000	1639250000
4	10.50	0.413	100	1639030000	1639260000
5	14.00	0.551	50	1639040000	1639270000
6	17.50	0.689	50	1639050000	1639280000
7	21.00	0.827	50	1639060000	1639290000
8	24.50	0.965	50	1639070000	1639300000
9	28.00	1.102	50	1639080000	1639310000
10	31.50	1.240	50	1639090000	1639320000
11	35.00	1.378	50	1639100000	1639330000
12	38.50	1.516	50	1639110000	1639340000
13	42.00	1.654	50	1639120000	1639350000
14	45.50	1.791	50	1639130000	1639360000
15	49.00	1.929	50	1639140000	1639370000
16	52.50	2.067	50	1639150000	1639380000
17	56.00	2.205	20	1639160000	1639390000
18	59.50	2.343	20	1639170000	1639400000
19	63.00	2.480	20	1639180000	1639410000
20	66.50	2.618	20	1639190000	1639420000
21	70.00	2.756	20	1639200000	1639430000
22	73.50	2.894	20	1639210000	1639440000
23	77.00	3.031	20	1639220000	1639450000
24	80.50	3.169	20	1639230000	1639460000

BL 3.50/./270

with screw flange



Dimensioned drawing

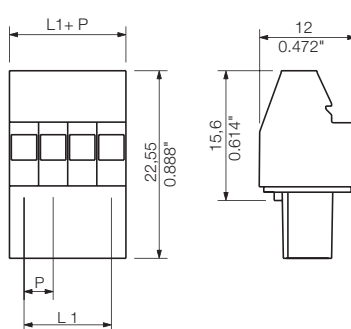

Ordering data

Solder pin length					
Colour	Orange		Black		
Pitch	3.50 mm				
Pol.	L1	(inch)	Qty.	Order No.	Order No.
2	3.50	0.138	100	1639470000	1639700000
3	7.00	0.276	100	1639480000	1639710000
4	10.50	0.413	100	1639490000	1639720000
5	14.00	0.551	50	1639500000	1639730000
6	17.50	0.689	50	1639510000	1639740000
7	21.00	0.827	50	1639520000	1639750000
8	24.50	0.965	50	1639530000	1639760000
9	28.00	1.102	50	1639540000	1639770000
10	31.50	1.240	50	1639550000	1639780000
11	35.00	1.378	50	1639560000	1639790000
12	38.50	1.516	50	1639570000	1639800000
13	42.00	1.654	50	1639580000	1639810000
14	45.50	1.791	50	1639590000	1639820000
15	49.00	1.929	50	1639600000	1639830000
16	52.50	2.067	50	1639610000	1639840000
17	56.00	2.205	20	1639620000	1639850000
18	59.50	2.343	20	1639630000	1639860000
19	63.00	2.480	20	1639640000	1639870000
20	66.50	2.618	20	1639650000	1639880000
21	70.00	2.756	20	1639660000	1639890000
22	73.50	2.894	20	1639670000	1639900000
23	77.00	3.031	20	1639680000	1639910000
24	80.50	3.169	20	1639690000	1639920000

BL 3.50/./270F

with screw flange



Dimensioned drawing

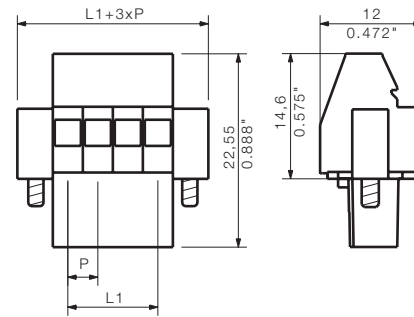

Ordering data

Solder pin length					
Colour	Orange		Black		
Pitch	3.50 mm				
Pol.	L1	(inch)	Qty.	Order No.	Order No.
2	3.50	0.138	100	1639930000	1640160000
3	7.00	0.276	100	1639940000	1640170000
4	10.50	0.413	100	1639950000	1640180000
5	14.00	0.551	50	1639960000	1640190000
6	17.50	0.689	50	1639970000	1640200000
7	21.00	0.827	50	1639980000	1640210000
8	24.50	0.965	50	1639990000	1640220000
9	28.00	1.102	50	1640000000	1640230000
10	31.50	1.240	50	1640010000	1640240000
11	35.00	1.378	50	1640020000	1640250000
12	38.50	1.516	50	1640030000	1640260000
13	42.00	1.654	50	1640040000	1640270000
14	45.50	1.791	50	1640050000	1640280000
15	49.00	1.929	50	1640060000	1640290000
16	52.50	2.067	50	1640070000	1640300000
17	56.00	2.205	20	1640080000	1640310000
18	59.50	2.343	20	1640090000	1640320000
19	63.00	2.480	20	1640100000	1640330000
20	66.50	2.618	20	1640110000	1640340000
21	70.00	2.756	20	1640120000	1640350000
22	73.50	2.894	20	1640130000	1640360000
23	77.00	3.031	20	1640140000	1640370000
24	80.50	3.169	20	1640150000	1640380000

BLZF 3.50/././180

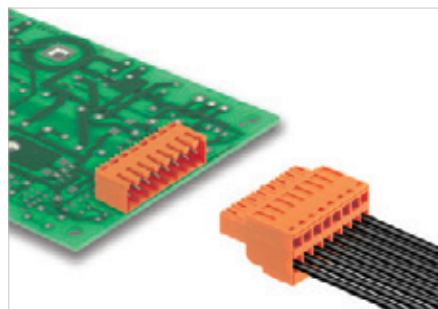

Female plug with tension-clamp wire connection in 3.5 mm pitch. Available with a screw flange (F), release lever (LH) or lock and release lever (LR). They include space for labelling and can be coded.

Product data

IEC: 320 V / 14.5 A / 0.2 - 1.5 mm²
UL: 300 V / 10 A / AWG 26 - 14

For additional articles and information, refer to catalog.weidmueller.com

Note:

- Additional colours on request
- Gold-plated contact surfaces on request
- Rated current related to rated cross-section & min. No. of poles.
- Max. outer diameter of the conductor: 2.9 mm
- Wire end ferrule without plastic collar to DIN 46228/1
- Wire end ferrule with plastic collar to DIN 46228/4
- Crimp shape A for wire-end ferrules with crimping tools PZ 1,5 (order no. 9005990000) or PZ 6/5 (order no. 9011460000) for larger wire cross-sections recommended.
- P on drawing = pitch
- Rated data refer only to the component itself. Clearance and creepage distances to other components are to be designed in accordance with the relevant application standards.

BLZF 3.50/././180



Dimensioned drawing

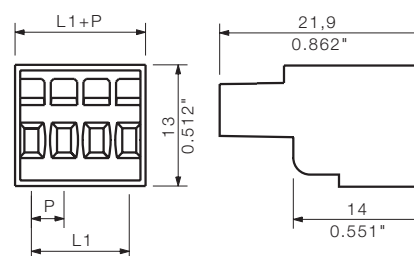

Technical data

In compliance with IEC 60664-1 / IEC 61984			
Clamping range, max.	mm ²	0.13...1.5	
Solid core H05(07) V-U	mm ²	0.2...1.5	
Stranded H07 V-R			
Flexible H05(07) V-K	mm ²	0.2...1.5	
Flexible with ferrule	mm ²	0.2...1.5	
Ferrule with plastic collar	mm ²	0.2...1	
Stripping length	mm	10	
Screwdriver blade	mm	0.4 x 2.5	
According to norm		DIN 5264-A	
Tightening torque range	Nm		
Rated current, max.	A	14.5	12
At ambient temperature		20°C	40°C
For conductor cross-section	mm ²	1.5	
Overvoltage category		III	III II
Pollution severity		3	2 2
Rated voltage	V	160 160	320
Rated impulse voltage	kV	2.5 2.5 2.5	
UL / CUL (Use Group)		B C D	
Rated voltage	V	300	300
Rated current	A	10	10
AWG conductor	AWG	26-14	
CSA (Use Group)		B C D	
Rated voltage	V	300	300
Rated current	A	10	10
AWG conductor	AWG	26-14	
General data			
Type of insulation material		PBT	
UL 94 flammability rating		V-0	
Contact base material		Copper alloy	
Material of contact surface		tinned	
Pin dimensions = d	mm		
Solder eyelet Ø = D	mm		
Solder eyelet Ø tolerance	mm		

Accessories

Note: Refer to the Accessories chapter for additional accessories.

Coding		Order No.
	BL SL 3.5 KO OR	1693430000
	BL SL 3.5 KO SW	1610100000
Strain relief		
	BL 3.5 ZE 3 OR	1629680000
	BL 3.5 ZE 3 SW	1627820000
	BL 3.5 ZE 8 OR	1629690000
	BL 3.5 ZE 8 SW	1627830000
Screwdriver		
	SDS 0.4X2.5X75	9009030000
Crimping tool		
	PZ 1.5	9005990000
	PZ 6/5	9011460000

Ordering data

Solder pin length						
Colour	Orange		Black			
Pitch	3.50 mm					
Pol.	L1	(inch)	Qty.	Order No.	Order No.	
2	3.50	0.138	100	1690190000	1690420000	
3	7.00	0.276	100	1690200000	1690430000	
4	10.50	0.413	100	1690210000	1690440000	
5	14.00	0.551	50	1690220000	1690450000	
6	17.50	0.689	50	1690230000	1690460000	
7	21.00	0.827	50	1690240000	1690470000	
8	24.50	0.965	50	1690250000	1690480000	
9	28.00	1.102	50	1690260000	1690490000	
10	31.50	1.240	50	1690270000	1690500000	
11	35.00	1.378	50	1690280000	1690510000	
12	38.50	1.516	50	1690290000	1690520000	
13	42.00	1.654	50	1690300000	1690530000	
14	45.50	1.791	50	1690310000	1690540000	
15	49.00	1.929	50	1690320000	1690550000	
16	52.50	2.067	50	1690330000	1690560000	
17	56.00	2.205	20	1690340000	1690570000	
18	59.50	2.343	20	1690350000	1690580000	
19	63.00	2.480	20	1690360000	1690590000	
20	66.50	2.618	20	1690370000	1690600000	
21	70.00	2.756	20	1690380000	1690610000	
22	73.50	2.894	20	1690390000	1690620000	
23	77.00	3.031	20	1690400000	1690630000	
24	80.50	3.169	20	1690410000	1690640000	

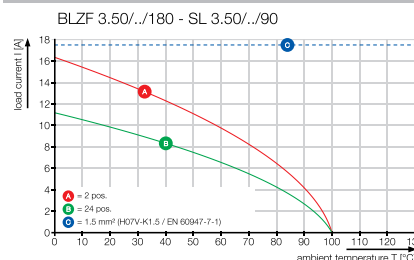

BLZF 3.50../180F

with screw flange



Dimensioned drawing

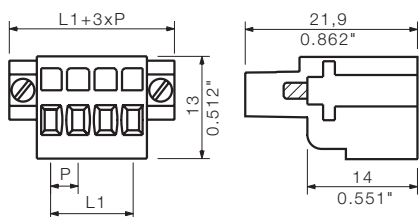

Ordering data

Solder pin length					
Colour	Orange		Black		
Pitch	3.50 mm				
Pol.	L1	(inch)	Qty.	Order No.	Order No.
2	3.50	0.138	100	1690880000	1691110000
3	7.00	0.276	100	1690890000	1691120000
4	10.50	0.413	100	1690900000	1691130000
5	14.00	0.551	50	1690910000	1691140000
6	17.50	0.689	50	1690920000	1691150000
7	21.00	0.827	50	1690930000	1691160000
8	24.50	0.965	50	1690940000	1691170000
9	28.00	1.102	50	1690950000	1691180000
10	31.50	1.240	50	1690960000	1691190000
11	35.00	1.378	50	1690970000	1691200000
12	38.50	1.516	50	1690980000	1691210000
13	42.00	1.654	50	1690990000	1691220000
14	45.50	1.791	50	1691000000	1691230000
15	49.00	1.929	50	1691010000	1691240000
16	52.50	2.067	50	1691020000	1691250000
17	56.00	2.205	20	1691030000	1691260000
18	59.50	2.343	20	1691040000	1691270000
19	63.00	2.480	20	1691050000	1691280000
20	66.50	2.618	20	1691060000	1691290000
21	70.00	2.756	20	1691070000	1691300000
22	73.50	2.894	20	1691080000	1691310000
23	77.00	3.031	20	1691090000	1691320000
24	80.50	3.169	20	1691100000	1691330000

BLZF 3.50../180LH

with release lever



Dimensioned drawing

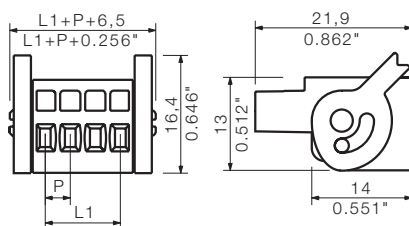

Ordering data

Solder pin length					
Colour	Orange		Black		
Pitch	3.50 mm				
Pol.	L1	(inch)	Qty.	Order No.	Order No.
2	3.50	0.138	100	1691570000	1691800000
3	7.00	0.276	100	1691580000	1691810000
4	10.50	0.413	100	1691590000	1691820000
5	14.00	0.551	50	1691600000	1691830000
6	17.50	0.689	50	1691610000	1691840000
7	21.00	0.827	50	1691620000	1691850000
8	24.50	0.965	50	1691630000	1691860000
9	28.00	1.102	50	1691640000	1691870000
10	31.50	1.240	50	1691650000	1691880000
11	35.00	1.378	50	1691660000	1691890000
12	38.50	1.516	50	1691670000	1691900000
13	42.00	1.654	50	1691680000	1691910000
14	45.50	1.791	50	1691690000	1691920000
15	49.00	1.929	50	1691700000	1691930000
16	52.50	2.067	50	1691710000	1691940000
17	56.00	2.205	20	1691720000	1691950000
18	59.50	2.343	20	1691730000	1691960000
19	63.00	2.480	20	1691740000	1691970000
20	66.50	2.618	20	1691750000	1691980000
21	70.00	2.756	20	1691760000	1691990000
22	73.50	2.894	20	1691770000	1692000000
23	77.00	3.031	20	1691780000	1692010000
24	80.50	3.169	20	1691790000	1692020000

BLZF 3.50../180LR

with release latch



Dimensioned drawing

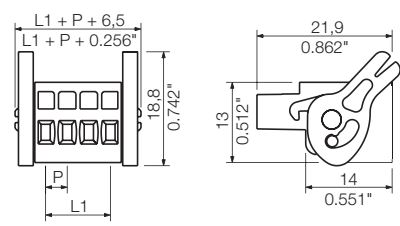

Ordering data

Solder pin length					
Colour	Orange				
Pitch	3.50 mm				
Pol.	L1	(inch)	Qty.	Order No.	Order No.
2	3.50	0.138	100	1379590000	1379590000
3	7.00	0.276	100	1134450000	1134450000
4	10.50	0.413	100	1134460000	1134460000
5	14.00	0.551	50	1134470000	1134470000
6	17.50	0.689	50	1134480000	1134480000
7	21.00	0.827	50	1134490000	1134490000
8	24.50	0.965	50	1134510000	1134510000
9	28.00	1.102	50	1134520000	1134520000
10	31.50	1.240	50	1134530000	1134530000
11	35.00	1.378	50	1134540000	1134540000
12	38.50	1.516	50	1134550000	1134550000
13	42.00	1.654	50	1134560000	1134560000
14	45.50	1.791	50	1134570000	1134570000
15	49.00	1.929	50	1134580000	1134580000
16	52.50	2.067	50	1134590000	1134590000

Compatible with SL-SMT 3.50../90RF

Additional deratings curves

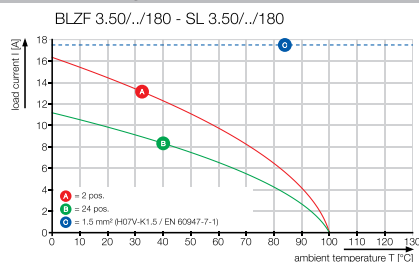

BLIDCB 3.50/./180

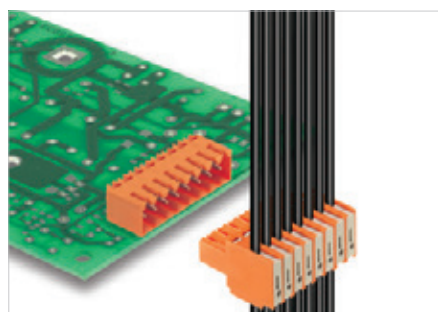

Female plug provides quick IDC wire connections in 3.5 mm pitch for bus applications. The female plugs are also available with a flange (F). They include space for labelling and can be coded.

Product data

IEC: 250 V / 6 A / 0.35 - 0.5 mm²
UL: 300 V / 7 A / AWG 22 - 20

For additional articles and information, refer to catalog.weidmueller.com

Note:

- Additional colours on request
- Rated current related to rated cross-section & min. No. of poles.
- For IDC contact 0.5: cable acc. to DIN EN 60352-4
- AWG conductor: solid, 7 or 19 strands only
- Temperature range -20 to +80 °C
- BLIDC 3.5 and BLIDCB 3.5 conductors „solid“/“flexible“ to DIN 47726
- P on drawing = pitch
- Rated data refer only to the component itself. Clearance and creepage distances to other components are to be designed in accordance with the relevant application standards.

BLIDCB 3.50/./180

Bus version



Dimensioned drawing

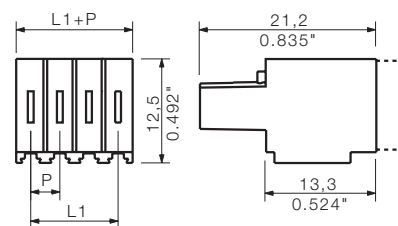

Technical data

In compliance with IEC 60664-1 / IEC 61984			
Clamping range, max.	mm ²	0.32...0.5	
Solid core H05(07) V-U	mm ²	0.35...0.5	
Stranded H07 V-R			
Flexible H05(07) V-K	mm ²	0.35...0.5	
Flexible with ferrule	mm ²		
Ferrule with plastic collar	mm ²		
Stripping length	mm		
Screwdriver blade	mm	0.4 x 2.5	
According to norm		DIN 5264-A	
Tightening torque range	Nm		
Rated current, max.	A	6	6
At ambient temperature		20°C	40°C
For conductor cross-section	mm ²	0.5	
Overvoltage category		III	III II
Pollution severity		3	2 2
Rated voltage	V	160	160 250
Rated impulse voltage	kV	2.5	2.5 2.5
UL / CUL (Use Group)	B C D		
Rated voltage	V	300	300
Rated current	A	7	7
AWG conductor	AWG		22-20
CSA (Use Group)	B C D		
Rated voltage	V	300	300
Rated current	A	7	7
AWG conductor	AWG		22-20
General data			
Type of insulation material		PBT	
UL 94 flammability rating		V-0	
Contact base material		CuSn	
Material of contact surface		tinned	
Pin dimensions = d	mm		
Solder eyelet Ø = D	mm		
Solder eyelet Ø tolerance	mm		

Accessories

Note: Refer to the Accessories chapter for additional accessories.

Coding		Order No.
	BL SL 3.5 KO OR	1693430000
	BL SL 3.5 KO SW	1610100000
Mounting block		
	BLIDCB 3.5 ASB	1770310000
Screwdriver		
	SDIS 0.4X2.5X75	9008370000
	SDS 0.4X2.5X75	9009030000

Ordering data

Solder pin length						
Colour	Orange		Black			
Pitch	3.50 mm					
Pol.	L1	(inch)	Qty.	Order No.	Order No.	
2	3.50	0.138	10	1751380000	1770670000	
3	7.00	0.276	10	1751390000	1770680000	
4	10.50	0.413	10	1751400000	1770690000	
5	14.00	0.551	10	1751410000	1770700000	
6	17.50	0.689	10	1751420000	1770710000	
7	21.00	0.827	10	1751430000	1770720000	
8	24.50	0.965	10	1751440000	1770730000	

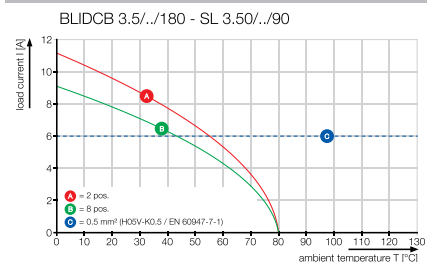

BLIDCB 3.50/./180F

Bus version; with screw flange



Dimensioned drawing

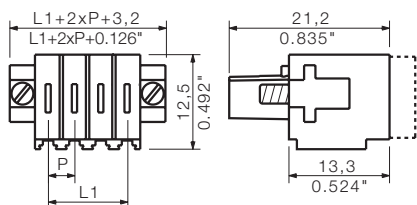

Ordering data

Solder pin length						
Colour		Orange	Black			
Pitch		3.50 mm				
Pol.	L1	(inch)	Qty.	Order No.	Order No.	
2	3.50	0.138	10	1751450000	1770740000	
3	7.00	0.276	10	1751460000	1770750000	
4	10.50	0.413	10	1751470000	1770760000	
5	14.00	0.551	10	1751480000	1770770000	
6	17.50	0.689	10	1751490000	1770780000	
7	21.00	0.827	10	1751500000	1770790000	
8	24.50	0.965	10	1751510000	1770800000	

BL-I/O 3.5/./180

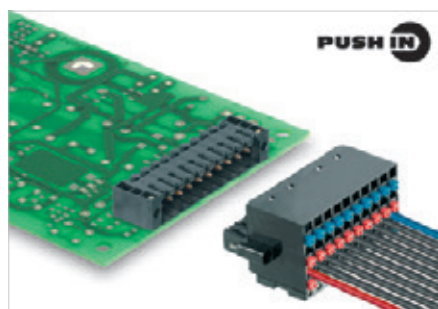

Female plug provides pluggable connection level for decentralized I/O electronics. It is used together with male headers in 3.5 mm pitch. Available with a screw flange (F) or a lock and release lever (LR).

Technical data

In compliance with IEC 60664-1 / IEC 61984			
Clamping range, max.	mm ²	0.2...1	
Solid core H05(07) V-U	mm²	0.2...1	
Stranded H07 V-R			
Flexible H05(07) V-K	mm ²	0.2...1	
Flexible with ferrule	mm ²	0.2...1	
Ferrule with plastic collar	mm ²	0.2...1	
Stripping length	mm	8	
Screwdriver blade	mm	0.4 x 2.5	
According to norm		DIN 5264	
Tightening torque range	Nm		
Rated current, max.	A	2.2	2.2
At ambient temperature		20°C	40°C
For conductor cross-section	mm ²	1	
Overvoltage category		III	III II
Pollution severity		3	2 2
Rated voltage	V	50 160 200	
Rated impulse voltage	kV	0.8	2.5 2.5
UL / CUL (Use Group)		B C D	
Rated voltage	V	50	50
Rated current	A	5	5
AWG conductor	AWG	22-16	
CSA (Use Group)		B C D	
Rated voltage	V	50	50
Rated current	A	5	5
AWG conductor	AWG	22-16	
General data			
Type of insulation material		PBT	
UL 94 flammability rating		V-0	
Contact base material		Copper alloy	
Material of contact surface		tinned	
Pin dimensions = d	mm		
Solder eyelet Ø = D	mm		
Solder eyelet Ø tolerance	mm		

Product data

IEC: 200 V / 2.2 A / 0.2 - 1 mm²
UL: 50 V / 5 A / AWG 22 - 16

For additional articles and information, refer to catalog.weidmueller.com

Note:

- Additional colours on request
- Crimp shape A for wire-end ferrules with crimping tools PZ 1,5 (order no. 9005990000) or PZ 6/5 (order no. 9011460000) for larger wire cross-sections recommended.
- Total load-carrying capacity of the potential bridges when feeding with 1.5 mm² is max. 17.5 A (so the capacity is 2.18 A for poles 2 through 9)
- Wire end ferrule without plastic collar to DIN 46228/1
- Wire end ferrule with plastic collar to DIN 46228/4
- Conductor < 0.2 mm² tinned
- Max. outer diameter of the conductor: 2.9 mm
- Rated data refer only to the component itself. Clearance and creepage distances to other components are to be designed in accordance with the relevant application standards.

BL-I/O 3.50/10/180F

with screw flange



Dimensioned drawing

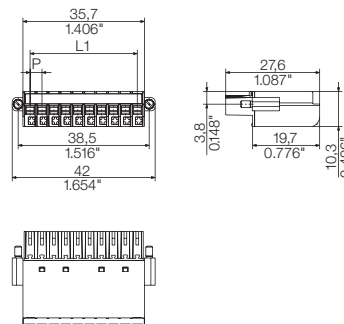

Accessories

Note: Refer to the Accessories chapter for additional accessories.

Coding		Order No.
	BL SL 3.5 KO OR	1693430000
	BL SL 3.5 KO SW	1610100000
Screwdriver		
	SDIS 0.4X2.5X75	9008370000
	SDS 0.4X2.5X75	9009030000
Crimping tool		
	PZ 1.5	9005990000
	PZ 6/5	9011460000

Ordering data

Solder pin length						
Colour		Light Grey	Black			
Pitch	3.50 mm					
Pol.	L1	(inch)	Qty.	Order No.	Order No.	
10	31.50	1.240	20	1871690000	1779880000	

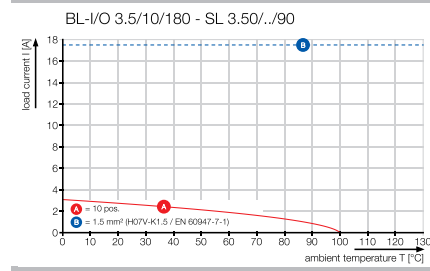

BL-I/O 3.50/10/180LR

with release latch



Dimensioned drawing

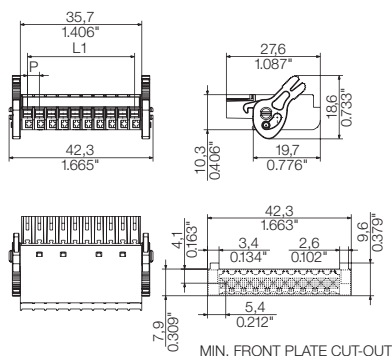

Ordering data

Solder pin length				
Colour				Black
Pitch 3.50 mm				
Pol.	L1	(inch)	Qty.	Order No.
10	31.50	1.240	20	1000540000

BL-I/O 3.50/30/180F

with screw flange



Dimensioned drawing

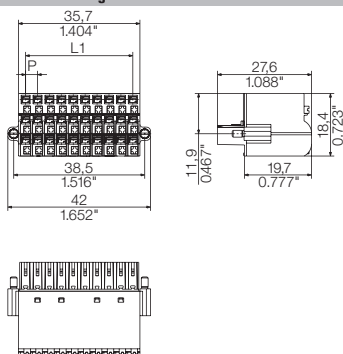

Ordering data

Solder pin length					
Colour				Light Grey	Black
Pitch 3.50 mm					
Pol.	L1	(inch)	Qty.	Order No.	Order No.
30	31.50	1.240	20	1965910000	1779920000

BL-I/O 3.50/30/180LR

with release latch



Dimensioned drawing

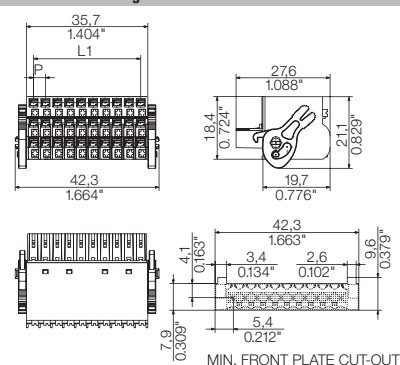

Ordering data

Solder pin length				
Colour				Black
Pitch 3.50 mm				
Pol.	L1	(inch)	Qty.	Order No.
30	31.50	1.240	20	1000550000

Additional deratings curves

BL-I/O 3.5/30/180 - SL 3.50/.../90

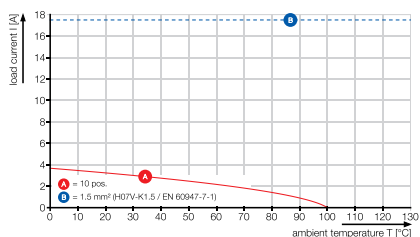

BL-I/O 3.50/./180 PNP LED

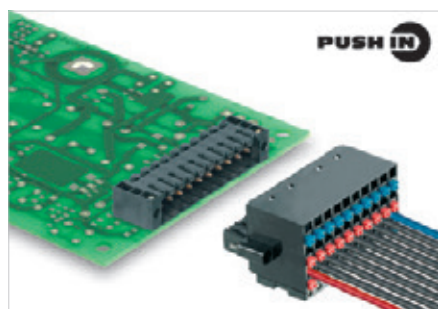

Female plug provides pluggable connection level with common minus (PNP sensor) for decentralized I/O electronics with integrated LED display; used together with male headers in 3.5 mm pitch. Available with a screw flange (F) or a lock an release lever (LR).

Technical data

In compliance with IEC 60664-1 / IEC 61984			
Clamping range, max.	mm ²	0.2...1	
Solid core H05(07) V-U	mm²	0.2...1	
Stranded H07 V-R			
Flexible H05(07) V-K	mm ²	0.2...1	
Flexible with ferrule	mm ²	0.2...1	
Ferrule with plastic collar	mm ²	0.2...1	
Stripping length	mm	8	
Screwdriver blade	mm	0.4 x 2.5	
According to norm		DIN 5264	
Tightening torque range	Nm		
Rated current, max.	A	2.2	2.2
At ambient temperature		20°C	40°C
For conductor cross-section	mm ²	1	
Overvoltage category		III	III II
Pollution severity		3	2 2
Rated voltage	V	50	
Rated impulse voltage	kV	0.8	
UL / CUL (Use Group)	B C D		
Rated voltage	V	50	50
Rated current	A	5	5
AWG conductor	AWG	22-16	
CSA (Use Group)	B C D		
Rated voltage	V	50	50
Rated current	A	5	5
AWG conductor	AWG	22-16	
General data			
Type of insulation material		PBT	
UL 94 flammability rating		V-0	
Contact base material		Copper alloy	
Material of contact surface		tinned	
Pin dimensions = d	mm		
Solder eyelet Ø = D	mm		
Solder eyelet Ø tolerance	mm		

Product data

IEC: / 2.2 A / 0.2 - 1 mm²
UL: 50 V / 5 A / AWG 22 - 16



For additional articles and information, refer to catalog.weidmuller.com

Note:

- LED operating voltage: 10 - 30V; LED operating current: 0.8mA at 24V
- Crimp shape A for wire-end ferrules with crimping tools PZ 1,5 (order no. 9005990000) or PZ 6/5 (order no. 9011460000) for larger wire cross-sections recommended.
- Total load-carrying capacity of the potential bridges when feeding with 1.5 mm² is max. 17.5 A (so the capacity is 2.18 A for poles 2 through 9)
- Wire end ferrule without plastic collar to DIN 46228/1
- Wire end ferrule with plastic collar to DIN 46228/4
- Conductor < 0.2 mm² tinned
- Max. outer diameter of the conductor: 2.9 mm
- Rated data refer only to the component itself. Clearance and creepage distances to other components are to be designed in accordance with the relevant application standards.

Accessories

Note: Refer to the Accessories chapter for additional accessories.

Coding		Order No.
	BL SL 3.5 KO OR	1693430000
	BL SL 3.5 KO SW	1610100000
Screwdriver		
	SDIS 0.4X2.5X75	9008370000
	SDS 0.4X2.5X75	9009030000
Crimping tool		
	PZ 1.5	9005990000
	PZ 6/5	9011460000

BL-I/O 3.50/10/180F PNP LED

with screw flange



Dimensioned drawing

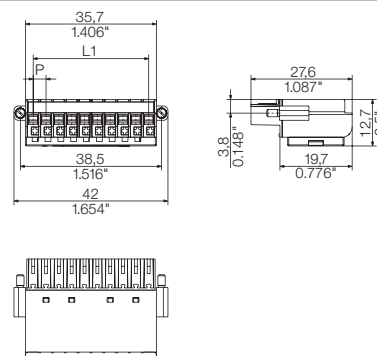

Ordering data

Solder pin length						
Colour		Light Grey	Black			
Pitch	3.50 mm					
Pol.	L1	(inch)	Qty.	Order No.	Order No.	
10	31.50	1.240	20	1965940000	1789090000	

LED series resistors designed for 24 V

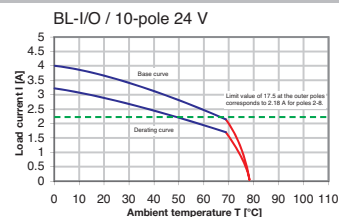

LED series resistors designed for 24 V

BL-I/O 3.50/10/180LR PNP LED

with release latch



Dimensioned drawing

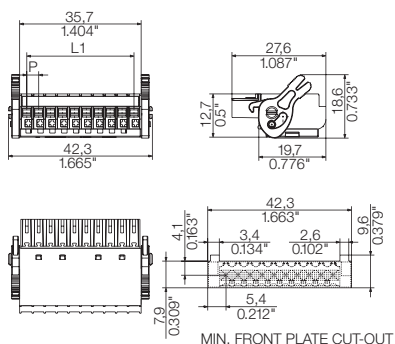

Ordering data

Solder pin length				
Colour				Black
Pitch		3.50 mm		
Pol.	L1	(inch)	Qty.	Order No.
10	31.50	1.240	20	1000560000

BL-I/O 3.50/30/180F PNP LED

with screw flange



Dimensioned drawing

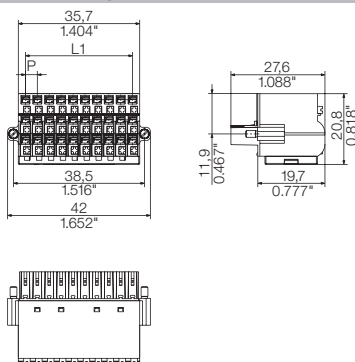

Ordering data

Solder pin length					
Colour				Light Grey	Black
Pitch		3.50 mm			
Pol.	L1	(inch)	Qty.	Order No.	Order No.
30	31.50	1.240	20	1965970000	1789110000

BL-I/O 3.50/30/180LR PNP LED

with release latch



Dimensioned drawing

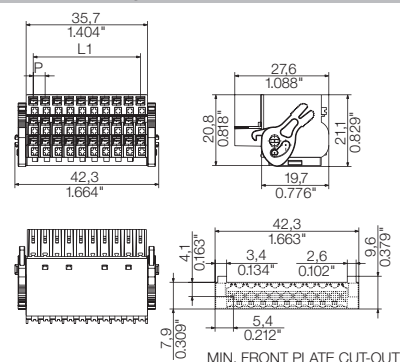

Ordering data

Solder pin length				
Colour				Black
Pitch		3.50 mm		
Pol.	L1	(inch)	Qty.	Order No.
30	31.50	1.240	20	1000570000

C

LED series resistors designed for 24 V

LED series resistors designed for 24 V

LED series resistors designed for 24 V

Additional deratings curves

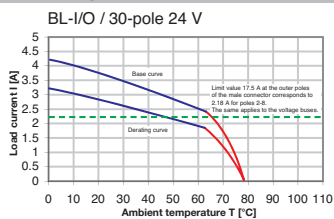

BL-I/O 3.50/./180 NPN LED

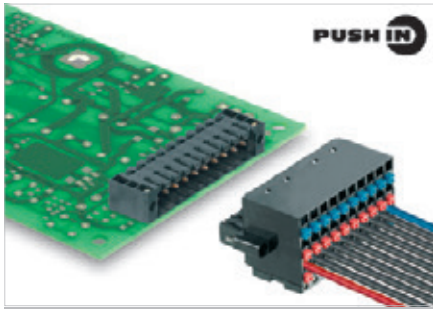

Female plug provides pluggable connection level with common positive (NPN sensor) for decentralized I/O electronics with integrated LED display; used together with male headers in 3.5 mm pitch. Available with a screw flange (F) or a lock an release lever (LR).

Technical data

In compliance with IEC 60664-1 / IEC 61984			
Clamping range, max.	mm ²	0.2...1	
Solid core H05(07) V-U	mm²	0.2...1	
Stranded H07 V-R			
Flexible H05(07) V-K	mm ²	0.2...1	
Flexible with ferrule	mm ²	0.2...1	
Ferrule with plastic collar	mm ²	0.2...1	
Stripping length	mm	8	
Screwdriver blade	mm	0.4 x 2.5	
According to norm		DIN 5264	
Tightening torque range	Nm		
Rated current, max.	A	2.2	2.2
At ambient temperature		20°C	40°C
For conductor cross-section	mm ²	1	
Overvoltage category		III	III II
Pollution severity		3	2 2
Rated voltage	V	50	
Rated impulse voltage	kV	0.8	
UL / CUL (Use Group)	B C D		
Rated voltage	V	50	50
Rated current	A	5	5
AWG conductor	AWG	22-16	
CSA (Use Group)	B C D		
Rated voltage	V	50	50
Rated current	A	5	5
AWG conductor	AWG	22-16	
General data			
Type of insulation material		PBT	
UL 94 flammability rating		V-0	
Contact base material		Copper alloy	
Material of contact surface		tinned	
Pin dimensions = d	mm		
Solder eyelet Ø = D	mm		
Solder eyelet Ø tolerance	mm		

Product data

IEC: / 2.2 A / 0.2 - 1 mm²
UL: 50 V / 5 A / AWG 22 - 16



For additional articles and information, refer to catalog.weidmueller.com

Note:

- LED operating voltage: 10 - 30V; LED operating current: 0.8mA at 24V
- Crimp shape A for wire-end ferrules with crimping tools PZ 1,5 (order no. 9005990000) or PZ 6/5 (order no. 9011460000) for larger wire cross-sections recommended.
- Total load-carrying capacity of the potential bridges when feeding with 1.5 mm² is max. 17.5 A (so the capacity is 2.18 A for poles 2 through 9)
- Wire end ferrule without plastic collar to DIN 46228/1
- Wire end ferrule with plastic collar to DIN 46228/4
- Conductor < 0.2 mm² tinned
- Max. outer diameter of the conductor: 2.9 mm
- Rated data refer only to the component itself. Clearance and creepage distances to other components are to be designed in accordance with the relevant application standards.

Accessories

Note: Refer to the Accessories chapter for additional accessories.

Coding		Order No.
	BL SL 3.5 KO OR	1693430000
	BL SL 3.5 KO SW	1610100000
Screwdriver		
	SDIS 0.4X2.5X75	9008370000
	SDS 0.4X2.5X75	9009030000
Crimping tool		
	PZ 1.5	9005990000
	PZ 6/5	9011460000

BL-I/O 3.50/10/180F NPN LED

with screw flange



Dimensioned drawing

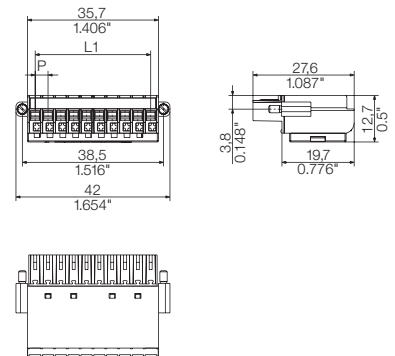

Ordering data

Solder pin length						
Colour	Light Grey		Black			
Pitch	3.50 mm					
Pol.	L1	(inch)	Qty.	Order No.	Order No.	
10	31.50	1.240	20	1965950000	1938010000	

LED series resistors designed for 24 V

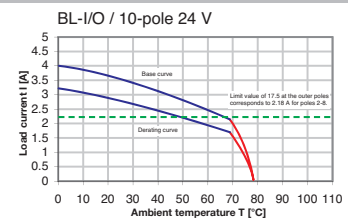

LED series resistors designed for 24 V

BL-I/O 3.50/10/180LR NPN LED

with release latch



Dimensioned drawing

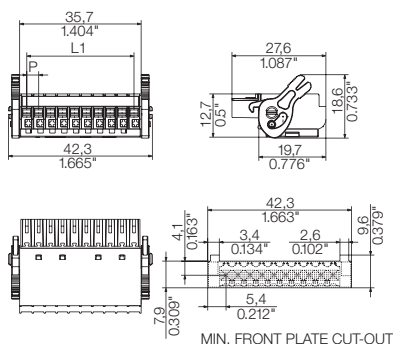

Ordering data

Solder pin length				
Colour				Black
Pitch		3.50 mm		
Pol.	L1	(inch)	Qty.	Order No.
10	31.50	1.240	20	1000580000

BL-I/O 3.50/30/180F NPN LED

with screw flange



Dimensioned drawing

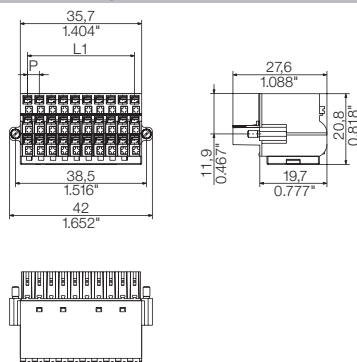

Ordering data

Solder pin length					
Colour				Light Grey	Black
Pitch		3.50 mm			
Pol.	L1	(inch)	Qty.	Order No.	Order No.
30	31.50	1.240	20	1965980000	1938020000

BL-I/O 3.50/30/180LR NPN LED

with release latch



Dimensioned drawing

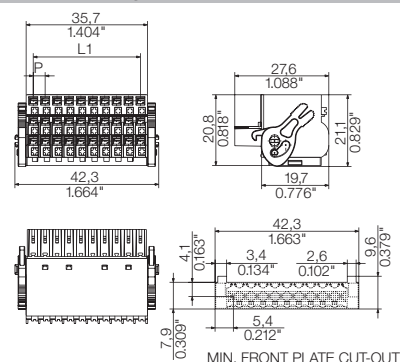

Ordering data

Solder pin length				
Colour				Black
Pitch		3.50 mm		
Pol.	L1	(inch)	Qty.	Order No.
30	31.50	1.240	20	1000590000

C

LED series resistors designed for 24 V

LED series resistors designed for 24 V

LED series resistors designed for 24 V

Additional deratings curves

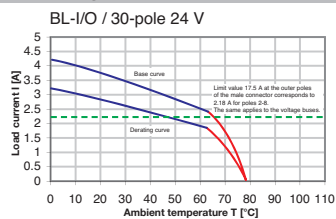

BL-I/O 3.50/./180

BL-I/O 3.5 30-pin

- Pluggable connection terminals for remote I/O electronics
- Directly from the control or industrial PC etc. to the sensor or actuator level
- Significant space savings as well as savings in design time and wiring.

BL-I/O 3.50/./180 PNP LED

BL-I/O 3.5 30-pin

- Pluggable connection terminals for remote I/O electronics
- Directly from the control or industrial PC etc. to the sensor or actuator level
- Significant space savings as well as savings in design time and wiring.

BL-I/O 3.50/./180 NPN LED

BL-I/O 3.5 30-pin

- Pluggable connection terminals for remote I/O electronics
- Directly from the control or industrial PC etc. to the sensor or actuator level
- Significant space savings as well as savings in design time and wiring.

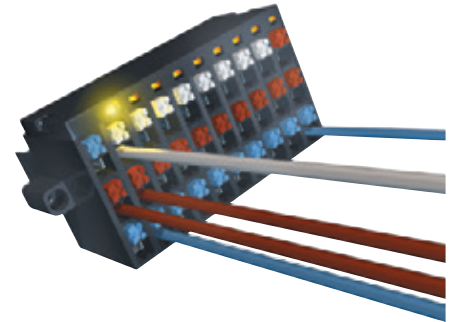
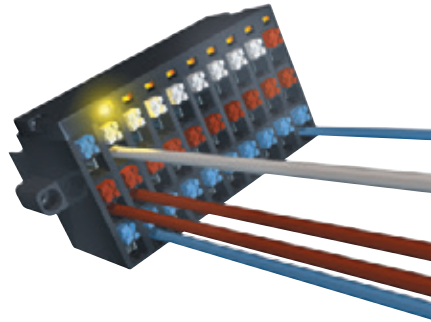

Integrated LED version

- Available for all the BL-I/Os
- Test the sensor or actuator cabling before commissioning the controller
- Eliminates the need for function displays in the housing

Integrated LED version

- Available for all the BL-I/Os
- Test the sensor or actuator cabling before commissioning the controller
- Eliminates the need for function displays in the housing

Diagram of BL-I/O 30 pin with SL 3.5 10 pin

- Direct connection possibilities for sensors and actuators including their power supply
- Can be used for external or internal power supply sources

Diagram of BL-I/O 30 pin with SL 3.5 10 pin

- Direct connection possibilities for sensors and actuators including their power supply
- Can be used for external or internal power supply sources

Diagram of BL-I/O 30 pin with SL 3.5 10 pin

- Direct connection possibilities for sensors and actuators including their power supply
- Can be used for external or internal power supply sources

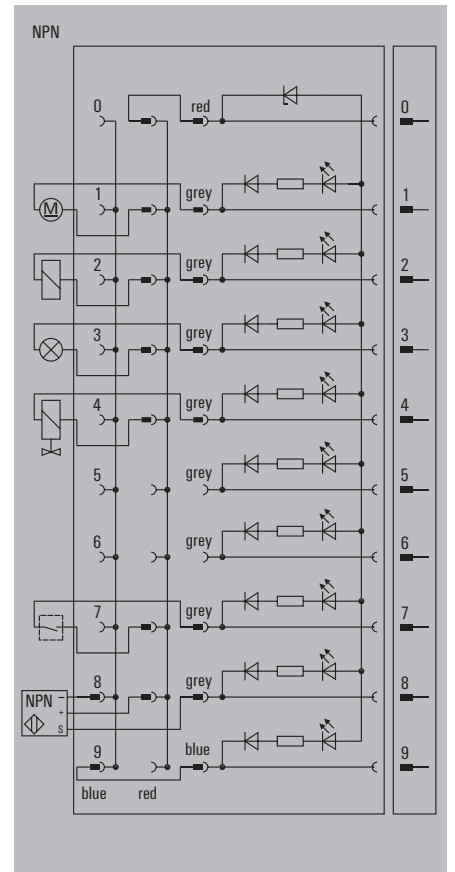
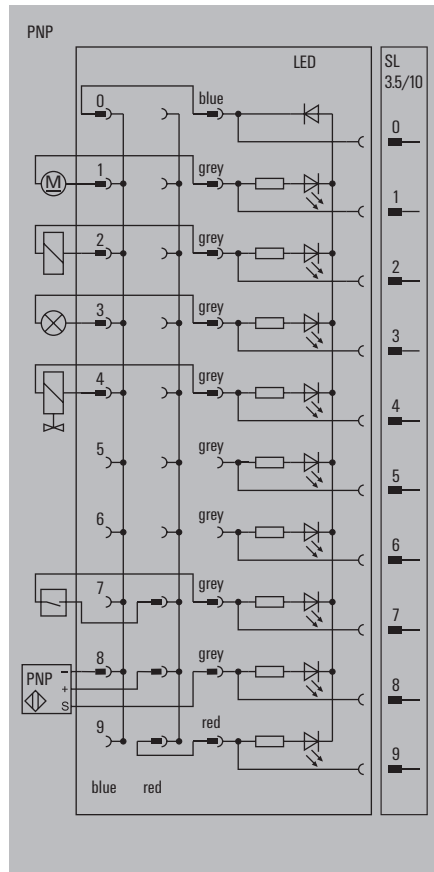
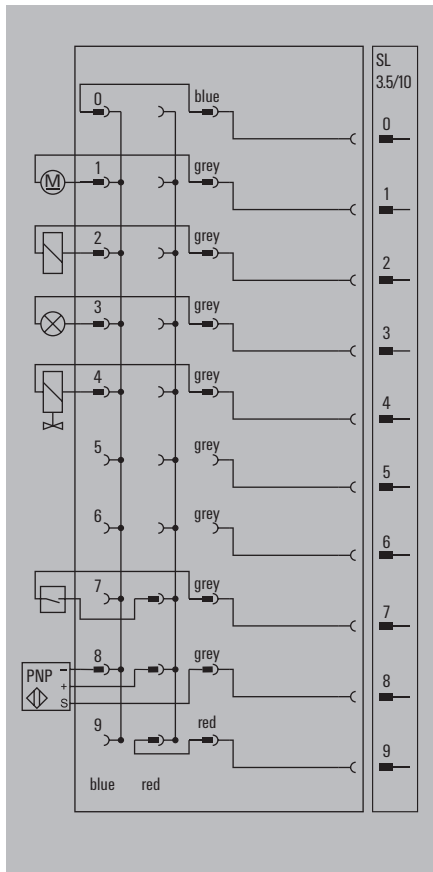

Plug-in connector OMNIMATE Signal 3.81

Opens up new dimensions for your application:

C

Large variety of products and an extensive accessory range

- All combinations are possible: wire-to-board, wire-to-wire, board-to-board, board-to-wire
- Wide range of reflow ready strips
- Individually configurable with accessories and specific printing or coding
- Compact design to connect 1.5 mm² wires

Unique performance offering high levels of redundancy

- Rated current: 17.5 A
- Up to 65 °C without derating
- Ambient temperature up to 120 °C

Safe handling characteristics

- Lock & Release lever allows tool-free locking and module-safe loosening
- Vibration resistant PUSH IN connection offers tool free wiring connection
- Proven screw connection

Simple handling

Reliable flange connections are easy to use and protect the electronic modules when they are removed: screw flange, release lever or lock & release lever.



Unique performance

High power reserves allow applications without restrictions up to the maximum wiring power rating - even in high ambient temperatures.

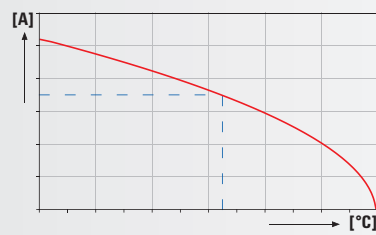

17.5 A @ 65°C

Less space required



Minimum stack height, maximum clamping force and PUSH IN: the SCDN 3.81 simply handles two 7.9 mm flat BCF 3.81 with 1.5 mm² wire end ferrules.

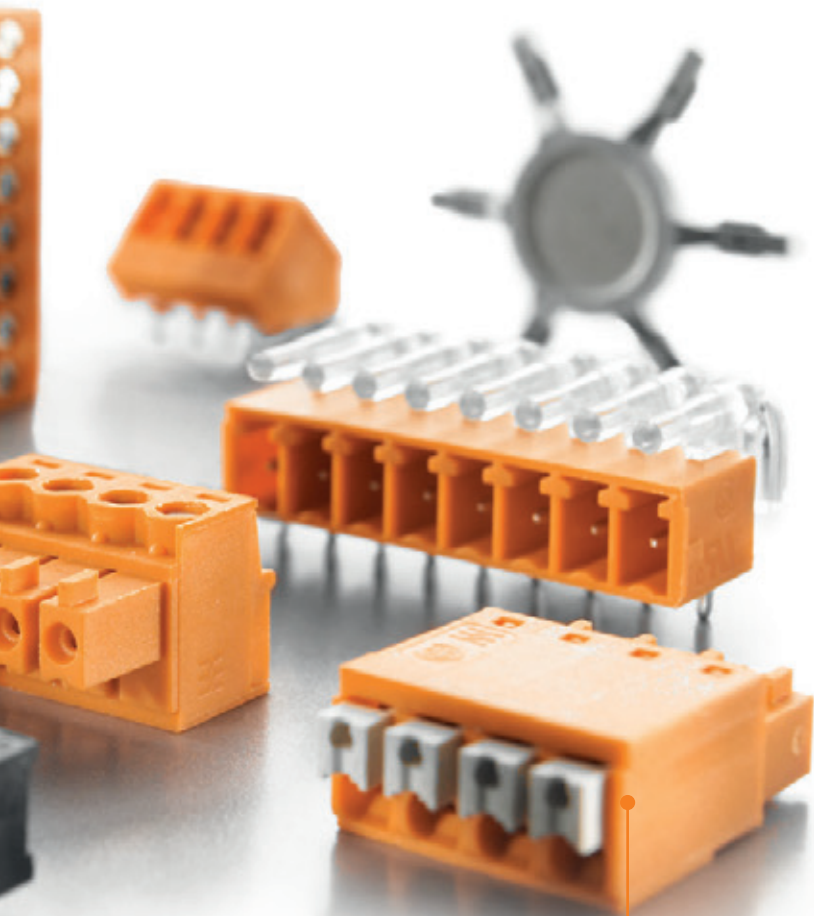

Maintenance-free, secure, vibration-proof

PUSH IN spring connection technology: direct connection without tools – simply plug in the prepared conductors – finished! Intuitive operation using large release buttons.



Complete system for all possible combinations and a comprehensive range of accessories

Wire-to-Board

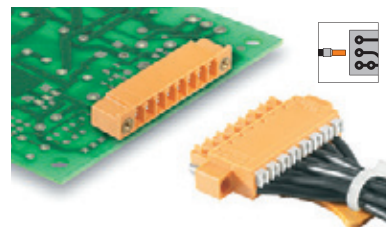

Wire-to-Wire

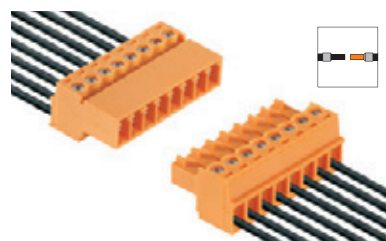

Board-to-Board

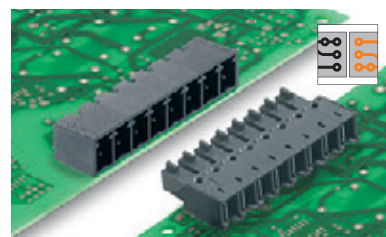

Board-to-Wire

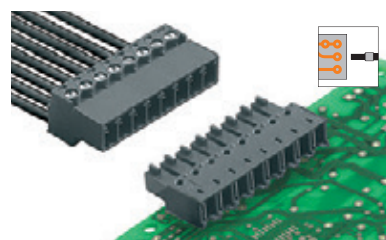

Accessories

Coding SC-SMT KO GR Light guide display SC FLA Cover hood BCZ AH



Plug-in connector OMNIMATE Signal 3.81

Brings new dimensions into handling

Best choice for reflow soldering

- Reflow strips made from the high temperature material LCP
- Form at high soldering temperatures stability
- Dimensionally stable
- Can be processed without drying (MSL 1)
- Thermal expansion properties similar to a FR4 PCB

Unique handling

- Suitable for automatic machine handling, antistatic packaging in tape, tray or tube
- Optional Pick & Place pad supports feeder systems
- Solder flange fixes the strip to the PCB without the use of screws
- An optimised pin end which permits AOI (automated optical inspection)
- Variable pin length to support placement on both sides of the PCB
- Integrated spacing bars improve the flow of heat during the solder process
- Free space in the pin area facilitate the development of the solder meniscus.

Packaging suitable for use in automated assembly

Standard belt widths for simple integration into the assembly process.

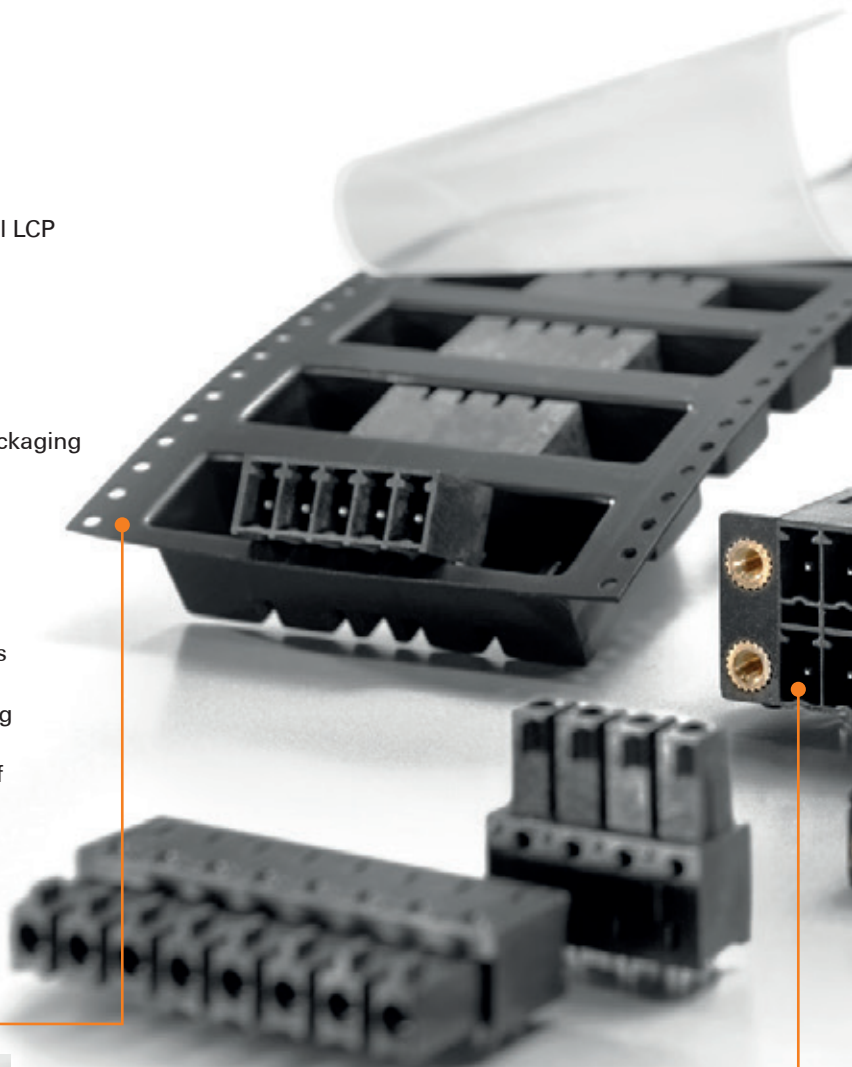

Code in advance – process universally

No additional work required for factory-side reflow-compatible coding.

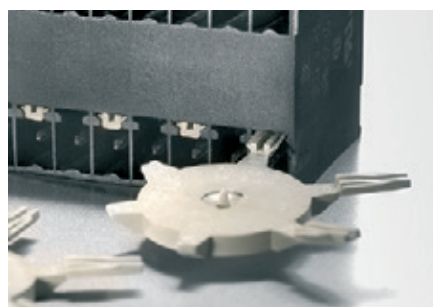

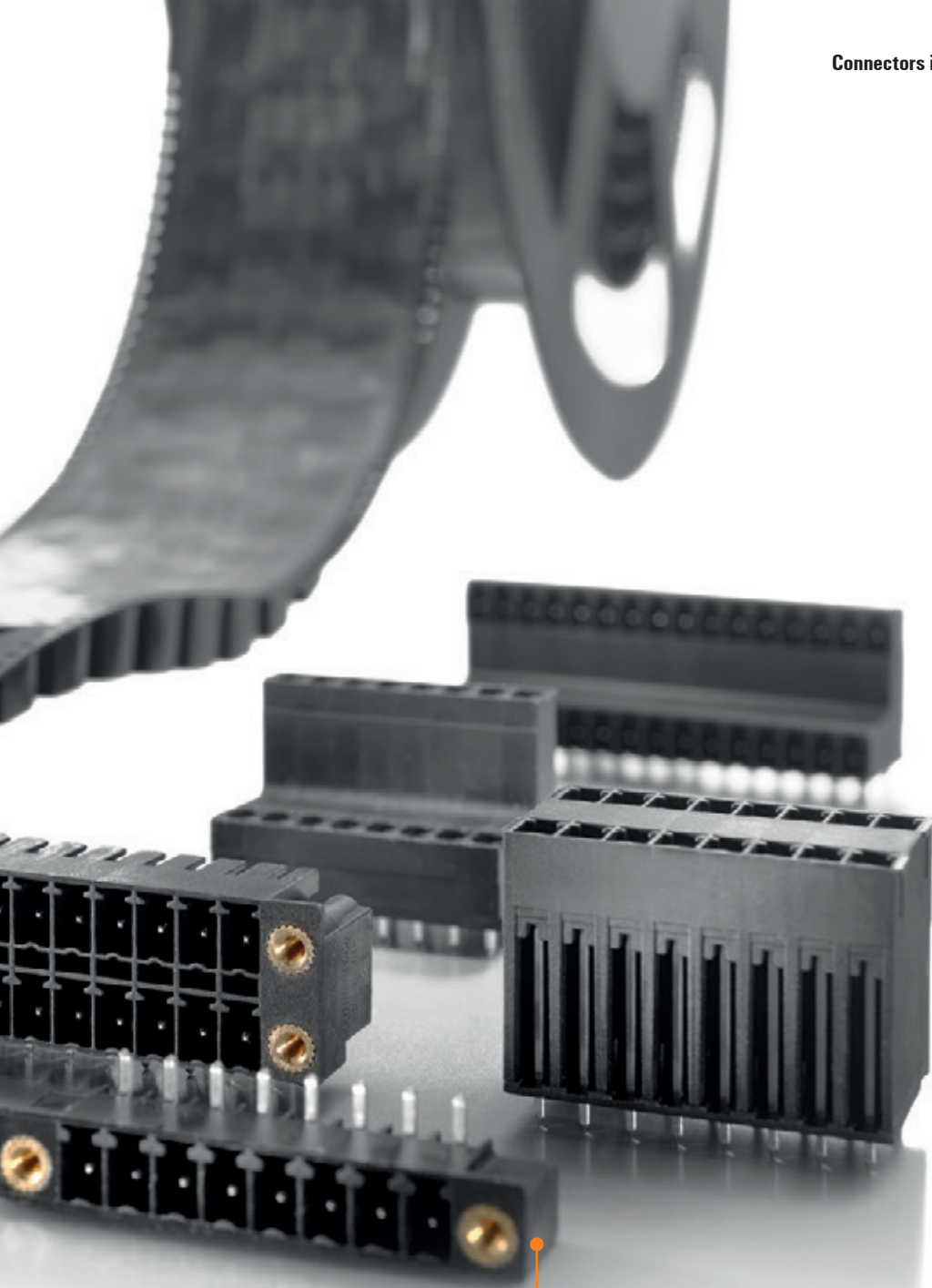

Solder flange pin

Secures to the PCB without a screw

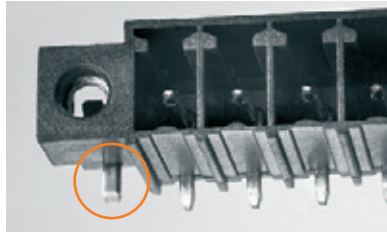

Integrated bars

Optimal airflow during reflow soldering

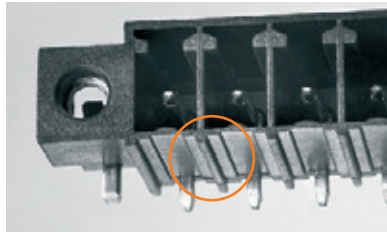

Rebates in the area of the pin

Space for the development of the solder meniscus

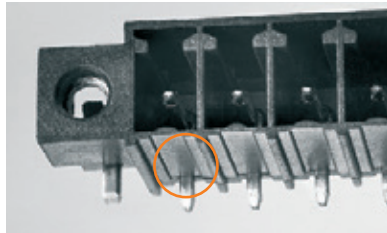

Pin tips

Optimal recognition by the automatic optical inspection device (AOI)

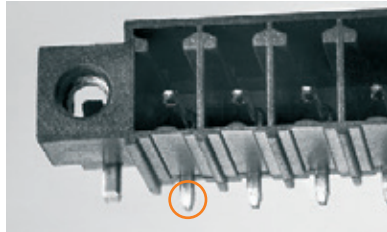



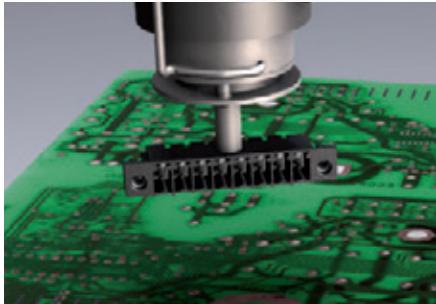

SMT

No need for pre-treatment, high temperature material LCP is safe to use during the soldering process.



<http://www.OMNIMATE.net>

-  = Wire-to-Board
-  = Board-to-Board
-  = Wire-to-Wire
-  = Board-to-Wire

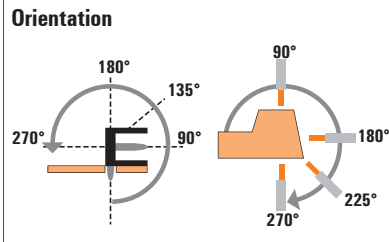

Male header

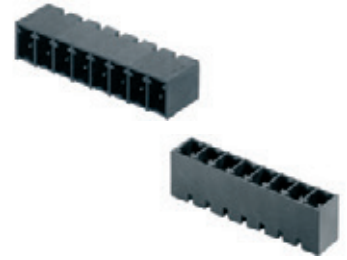

Levels

1

Orientation

IEC / UL

90°	180°
IEC: 320 V/17.5 A UL: 300 V/10 A	IEC: 320 V/17.5 A UL: 300 V/10 A

C

BC/SC 3.81 series



Solder connection

Type

Flange options

Page

SC	SC
G/F	G/F
C.84	C.86



















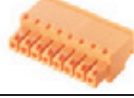

Reflow solder connection

Type

Flange options

Page

SC-SMT	SC-SMT
G/LF	G/LF
C.66	C.68

Female plug	Screw	Image	Type	Orientation	Flange options	IEC / UL	Page	Solder connection		Reflow solder connection	
								SC	SC	SC-SMT	SC-SMT
Female plug	Screw		BCZ	180°	(G)/F/LR	IEC: 320 V/17.5 A/0.2 - 1.5 mm ² UL: 300 V/10 A/AWG 28 - 16	C.106				
			BCZ	90°	(G)/F	IEC: 320 V/17.5 A/0.2 - 1.5 mm ² UL: 300 V/10 A/AWG 28 - 16	C.110				
			BCZ	270°	(G)/F	IEC: 320 V/17.5 A/0.2 - 1.5 mm ² UL: 300 V/10 A/AWG 28 - 16	C.111				
Female plug	PUSH IN		BCF	180°	(G)/F/LR	IEC: 320 V/17.5 A/0.14 - 1.5 mm ² UL: 300 V/10 A/AWG 24 - 16	C.112				
			BCL SMT	90°	(G)/F/LFI	IEC: 320 V/17.5 A UL: 300 V/10 A	C.116				
Female header	Solder connection		BCL SMT	180°	(G)/LFI	IEC: 320 V/17.5 A UL: 300 V/10 A	C.118				

Female plug and header:

- (G)* = Closed (without flange)
- F = Flange with screw
- LFI = Inverted solder flange with nut
- LR = Lock & Release lever

Male header and plug:

- G = Closed (without flange)
- F = Screw flange with nut
- LF = Solder flange with nut
- LR = Lock & Release lever
- FI = Inverted flange with screw

* not included in the article description

Male header **Male plug**

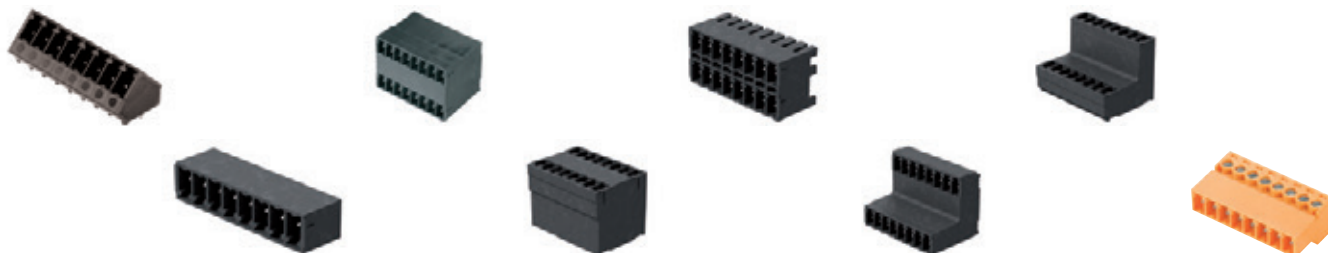

1		2						1
135°	270°	90°	180°	90°	90°	180°	180°	
IEC: 320 V/17.5 A UL: 300 V/10 A	IEC: 320 V/17.5 A UL: 300 V/10 A	IEC: 320 V/17.5 A UL: 300 V/10 A	IEC: 320 V/17.5 A UL: 300 V/10 A	IEC: 320 V/17.5 A UL: 300 V/10 A	IEC: 320 V/17.5 A UL: 300 V/10 A	IEC: 320 V/17.5 A UL: 300 V/10 A	IEC: 320 V/17.5 A UL: 300 V/10 A	IEC: 320 V/17.5 A/ 0.2 - 1.5 mm ² UL: 300 V/10 A/ AWG 28 - 16

Solder connection



Screw

SC	SC	SCD	SCD	SCDN	SCDV	SCDV	SCZ
G/F	G/F	G/F	G/F	G/F	G/F	G/F	G/F/FI/LR
C.88	C.90	C.92	C.94	C.96	C.98	C.100	

Reflow solder connection

SC-SMT	SC-SMT	SCD-THR	SCD-THR	SCDN-THR	SCDV-THR	SCDV-THR	
G/LF	G/F	G/F	G/F	G/F	G/F	G/F	C.102
C.70	C.72	C.74	C.76	C.78	C.80	C.82	
○	○	○	○	○	○	○	●
○	○	○	○	○	○	○	●
○	○	○	○	○	○	○	●
○	○	○	○	○	○	○	●
●	●	●	●	●	●	●	●
●	●	●	●	●	●	●	●

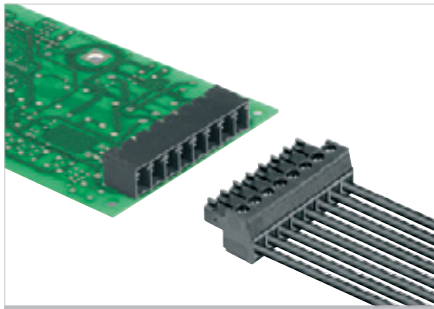
SC-SMT 3.81/./90



High-temperature-resistant male header.

- Plugging direction parallel to PCB
- Available in closed (G) and with solder flange (LF).
- Packed either in box (BX) or on anti-static roll (tape-on-reel, RL)
- Pin length of either 1.5 mm or 3.2 mm

Weidmüller's 3.81 mm pitch (0.15 inch) plug-in connectors are compatible with the layouts of standard connectors and offer space for labelling and coding.

Technical data

In compliance with IEC 60664-1 / IEC 61984

Clamping range, max.	mm ²		
Solid core H05(07) V-U	mm²		
Stranded H07 V-R			
Flexible H05(07) V-K	mm ²		
Flexible with ferrule	mm ²		
Ferrule with plastic collar	mm ²		
Stripping length	mm		
Screwdriver blade	mm		
According to norm			
Tightening torque range	Nm		
Rated current, max.	A	17.5	17
At ambient temperature		20°C	40°C
For conductor cross-section	mm ²		
Overvoltage category		III	III II
Pollution severity		3	2 2
Rated voltage	V	160	160 320
Rated impulse voltage	kV	2.5	2.5 2.5
UL / CUL (Use Group)		B	C D
Rated voltage	V	300	300
Rated current	A	10	10
AWG conductor	AWG		-
CSA (Use Group)		B	C D
Rated voltage	V	300	300
Rated current	A	10	10
AWG conductor	AWG		-
General data			
Type of insulation material		LCP GF	
UL 94 flammability rating		V-0	
Contact base material		Copper alloy	
Material of contact surface		tinned	
Pin dimensions = d	mm	1.0, Octagonal	
Solder eyelet Ø = D	mm	1.3	
Solder eyelet Ø tolerance	mm	+ 0,1	

Product data

IEC: 320 V / 17.5 A
UL: 300 V / 10 A

For additional articles and information, refer to catalog.weidmueller.com

Note:

- Gold-plated contact surfaces on request
- Rated current related to rated cross-section & min. No. of poles.
- Rated data refer only to the component itself. Clearance and creepage distances to other components are to be designed in accordance with the relevant application standards.
- P on drawing = pitch

SC-SMT 3.81/./90G Box

closed side

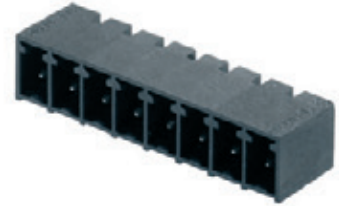

Dimensioned drawing

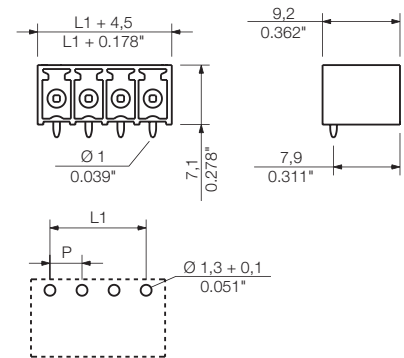

Accessories

Note: Refer to the Accessories chapter for additional accessories.

Coding		Order No.
	SC-SMT 3.81 KO GR	1968900000

Ordering data

Solder pin length	1.5 mm		3.2 mm	
	Black		Black	
Pitch	3.81 mm			
Pol.	L1 (inch)	Qty.	Order No.	Order No.
2	3.81 0.150	50	1862960000	1862460000
3	7.62 0.300	50	1862970000	1862480000
4	11.43 0.450	50	1862980000	1862490000
5	15.24 0.600	50	1862990000	1862500000
6	19.05 0.750	50	1863000000	1862510000
7	22.86 0.900	50	1863040000	1862520000
8	26.67 1.050	50	1863050000	1862530000
9	30.48 1.200	50	1863060000	1862540000
10	34.29 1.350	50	1863070000	1862550000
11	38.10 1.500	50	1863080000	1862570000
12	41.91 1.650	50	1863090000	1862730000
13	45.72 1.800	50	1863100000	1862740000
14	49.53 1.950	50	1863110000	1862760000
15	53.34 2.100	50	1863120000	1862780000
16	57.15 2.250	50	1863130000	1862800000

SC-SMT 3.81../90G Tape

closed side; tape-on-reel



Dimensioned drawing

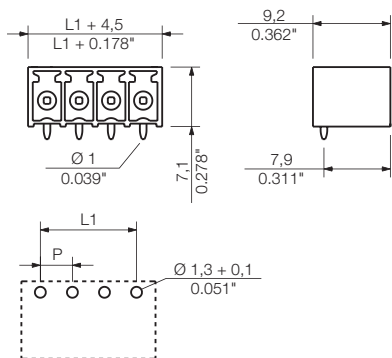

Ordering data

Solder pin length		1.5 mm	3.2 mm		
Colour		Black	Black		
Pitch		3.81 mm			
Pol.	L1 (inch)	Qty.	Order No.	Order No.	
2	3.81	0.150	400	1863140000	1862810000
3	7.62	0.300	400	1863150000	1862840000
4	11.43	0.450	400	1863160000	1862860000
5	15.24	0.600	400	1863170000	1862870000
6	19.05	0.750	400	1863180000	1862880000
7	22.86	0.900	400	1863190000	1862890000
8	26.67	1.050	400	1863200000	1862900000
9	30.48	1.200	400	1863210000	1862910000
10	34.29	1.350	400	1863220000	1862930000

Tape widths: 32, 44, 56, 72, 88

SC-SMT 3.81../90LF Box

with solder flange



Dimensioned drawing

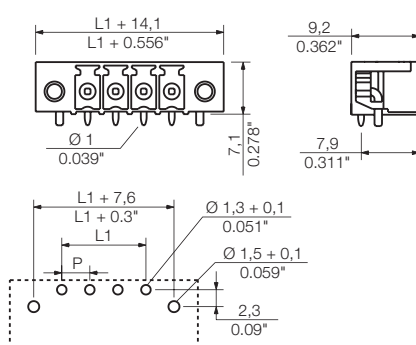

Ordering data

Solder pin length		1.5 mm	3.2 mm		
Colour		Black	Black		
Pitch		3.81 mm			
Pol.	L1 (inch)	Qty.	Order No.	Order No.	
2	3.81	0.150	50	1862560000	1863670000
3	7.62	0.300	50	1862580000	1863680000
4	11.43	0.450	50	1862590000	1863690000
5	15.24	0.600	50	1862600000	1863700000
6	19.05	0.750	50	1862610000	1863710000
7	22.86	0.900	50	1862620000	1863740000
8	26.67	1.050	50	1862630000	1863760000
9	30.48	1.200	50	1862640000	1863770000
10	34.29	1.350	50	1862650000	1863790000
11	38.10	1.500	50	1862660000	1863810000
12	41.91	1.650	50	1862670000	1863820000
13	45.72	1.800	50	1862680000	1863840000
14	49.53	1.950	50	1862690000	1863850000
15	53.34	2.100	50	1862700000	1863860000
16	57.15	2.250	50	1862710000	1863870000

SC-SMT 3.81../90LF Tape

with solder flange; tape-on-reel



Dimensioned drawing

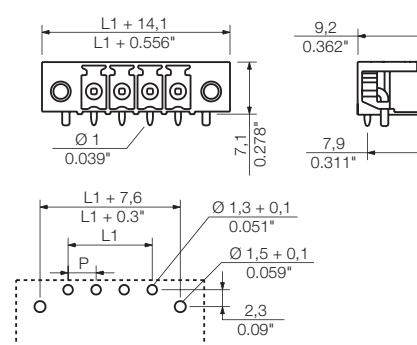

Ordering data

Solder pin length		1.5 mm	3.2 mm		
Colour		Black	Black		
Pitch		3.81 mm			
Pol.	L1 (inch)	Qty.	Order No.	Order No.	
2	3.81	0.150	400	1862720000	1863890000
3	7.62	0.300	400	1862750000	1863970000
4	11.43	0.450	400	1862770000	1863980000
5	15.24	0.600	400	1862790000	1863990000
6	19.05	0.750	400	1862820000	1864000000
7	22.86	0.900	400	1862830000	1864010000
8	26.67	1.050	400	1862850000	1864020000

Tape widths: 32, 44, 56, 72, 88

SC-SMT 3.81/./180

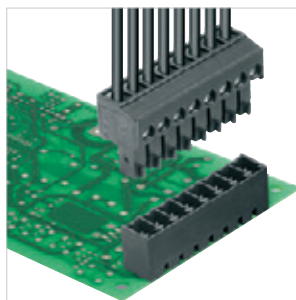

High-temperature-resistant male header.

- Plugging direction is perpendicular to PCB
- Available in closed (G) and with solder flange (LF).
- Packed either in box (BX) or on anti-static roll (tape-on-reel, RL)
- Pin length of either 1.5 mm or 3.2 mm

Weidmüller's 3.81 mm pitch (0.15 inch) plug-in connectors are compatible with the layouts of standard connectors and offer space for labelling and coding.

Technical data

In compliance with IEC 60664-1 / IEC 61984			
Clamping range, max.	mm ²		
Solid core H05(07) V-U	mm²		
Stranded H07 V-R			
Flexible H05(07) V-K	mm ²		
Flexible with ferrule	mm ²		
Ferrule with plastic collar	mm ²		
Stripping length	mm		
Screwdriver blade	mm		
According to norm			
Tightening torque range	Nm		
Rated current, max.	A	17.5	17
At ambient temperature		20°C	40°C
For conductor cross-section	mm ²		
Overvoltage category		III	III II
Pollution severity		3	2 2
Rated voltage	V	160	160 320
Rated impulse voltage	kV	2.5	2.5 2.5
UL / CUL (Use Group)		B	C D
Rated voltage	V	300	300
Rated current	A	10	10
AWG conductor	AWG		-
CSA (Use Group)		B	C D
Rated voltage	V	300	300
Rated current	A	10	10
AWG conductor	AWG		-
General data			
Type of insulation material		LCP GF	
UL 94 flammability rating		V-0	
Contact base material		Copper alloy	
Material of contact surface		tinned	
Pin dimensions = d	mm	1.0, Octagonal	
Solder eyelet Ø = D	mm	1.3	
Solder eyelet Ø tolerance	mm	+ 0,1	

Product data

IEC: 320 V / 17.5 A
UL: 300 V / 10 A

For additional articles and information, refer to catalog.weidmueller.com

Note:

- Gold-plated contact surfaces on request
- Rated current related to rated cross-section & min. No. of poles.
- Rated data refer only to the component itself. Clearance and creepage distances to other components are to be designed in accordance with the relevant application standards.
- P on drawing = pitch

SC-SMT 3.81/./180G Box

closed side



Dimensioned drawing

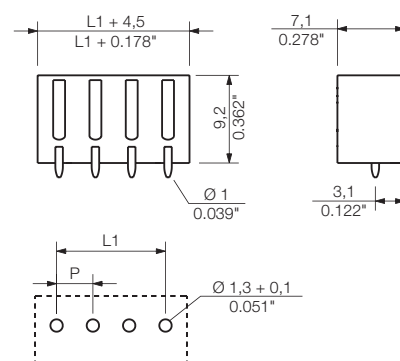

Accessories

Note: Refer to the Accessories chapter for additional accessories.

Coding		Order No.
	SC-SMT 3.81 KO GR	1968900000

Ordering data

Solder pin length	1.5 mm		3.2 mm	
	Colour	Black	Black	Black
Pitch	3.81 mm			
Pol.	L1 (inch)	Qty.	Order No.	Order No.
2	3.81 0.150	50	1863720000	1862920000
3	7.62 0.300	50	1863730000	1862940000
4	11.43 0.450	50	1863750000	1862950000
5	15.24 0.600	50	1863780000	1863010000
6	19.05 0.750	50	1863830000	1863020000
7	22.86 0.900	50	1863880000	1863030000
8	26.67 1.050	50	1863900000	1863240000
9	30.48 1.200	50	1863910000	1863270000
10	34.29 1.350	50	1863920000	1863290000
11	38.10 1.500	50	1863930000	1863320000
12	41.91 1.650	50	1863940000	1863330000
13	45.72 1.800	50	1863950000	1863350000
14	49.53 1.950	50	1863960000	1863370000
15	53.34 2.100	50	1864030000	1863400000
16	57.15 2.250	50	1864040000	1863420000

SC-SMT 3.81../180G Tape

closed side; tape-on-reel



Dimensioned drawing

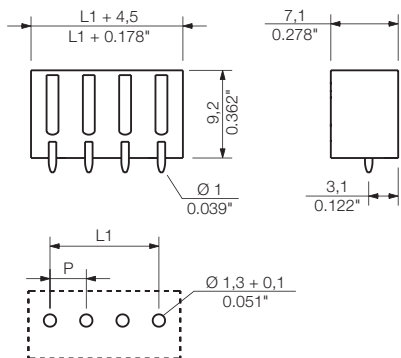

Ordering data

Solder pin length		1.5 mm	3.2 mm		
Colour		Black	Black		
Pitch 3.81 mm					
Pol.	L1 (inch)	Qty.	Order No.		
2	3.81	0.150	300	1864050000	1863450000
3	7.62	0.300	300	1864060000	1863470000
4	11.43	0.450	300	1864290000	1863490000
5	15.24	0.600	300	1864300000	1863540000
6	19.05	0.750	300	1864310000	1863560000
7	22.86	0.900	300	1864320000	1863570000
8	26.67	1.050	300	1864330000	1863590000
9	30.48	1.200	300	1864340000	1863630000
10	34.29	1.350	300	1864350000	1863660000

Tape widths: 32, 44, 56, 72, 88

SC-SMT 3.81../180LF Box

with solder flange



Dimensioned drawing

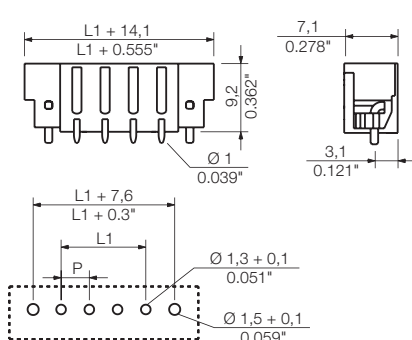

Ordering data

Solder pin length		1.5 mm	3.2 mm		
Colour		Black	Black		
Pitch 3.81 mm					
Pol.	L1 (inch)	Qty.	Order No.		
2	3.81	0.150	50	1864070000	1863230000
3	7.62	0.300	50	1864080000	1863250000
4	11.43	0.450	50	1864090000	1863260000
5	15.24	0.600	50	1864100000	1863280000
6	19.05	0.750	50	1864110000	1863300000
7	22.86	0.900	50	1864120000	1863310000
8	26.67	1.050	50	1864130000	1863340000
9	30.48	1.200	50	1864140000	1863360000
10	34.29	1.350	50	1864150000	1863380000
11	38.10	1.500	50	1864160000	1863390000
12	41.91	1.650	50	1864170000	1863410000
13	45.72	1.800	50	1864180000	1863430000
14	49.53	1.950	50	1864190000	1863440000
15	53.34	2.100	50	1864200000	1863460000
16	57.15	2.250	50	1864210000	1863480000

SC-SMT 3.81../180LF Tape

with solder flange; tape-on-reel



Dimensioned drawing

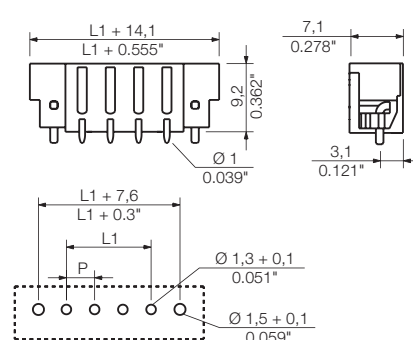

Ordering data

Solder pin length		1.5 mm	3.2 mm		
Colour		Black	Black		
Pitch 3.81 mm					
Pol.	L1 (inch)	Qty.	Order No.		
2	3.81	0.150	300	1864220000	1863500000
3	7.62	0.300	300	1864230000	1863510000
4	11.43	0.450	300	1864240000	1863530000
5	15.24	0.600	300	1864250000	1863580000
6	19.05	0.750	300	1864260000	1863600000
7	22.86	0.900	300	1864270000	1863620000
8	26.67	1.050	300	1864280000	1863640000

Tape widths: 32, 44, 56, 72, 88

SC-SMT 3.81../135

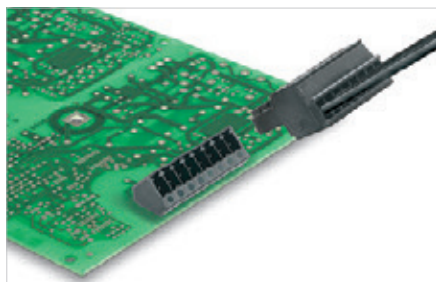

Male header with 135° plugging angle (135° angle between the plugging direction and the solder pin). This corresponds to a 45° angle between the wire orientation and the circuit board.

- Reflow compatible
- Available in closed (G) and with solder flange (LF).
- Pin length of either 1.5 mm or 3.2 mm

Weidmüller's 3.81 mm pitch (0.15 inch) plug-in connectors are compatible with the layouts of standard connectors and offer space for labelling and coding.

Technical data

In compliance with IEC 60664-1 / IEC 61984			
Clamping range, max.	mm ²		
Solid core H05(07) V-U	mm²		
Stranded H07 V-R			
Flexible H05(07) V-K	mm ²		
Flexible with ferrule	mm ²		
Ferrule with plastic collar	mm ²		
Stripping length	mm		
Screwdriver blade	mm		
According to norm			
Tightening torque range	Nm		
Rated current, max.	A	17.5	17.5
At ambient temperature		20°C	40°C
For conductor cross-section	mm ²		
Overvoltage category		III	III II
Pollution severity		3	2 2
Rated voltage	V	160	160 320
Rated impulse voltage	kV	2.5	2.5 2.5
UL / CUL (Use Group)		B	C D
Rated voltage	V	300	300
Rated current	A	10	10
AWG conductor	AWG		
CSA (Use Group)		B	C D
Rated voltage	V	300	300
Rated current	A	10	10
AWG conductor	AWG		
General data			
Type of insulation material		LCP GF	
UL 94 flammability rating		V-0	
Contact base material		Copper alloy	
Material of contact surface		tinned	
Pin dimensions = d	mm	1.0, Octagonal	
Solder eyelet Ø = D	mm	1.3	
Solder eyelet Ø tolerance	mm	+ 0,1	

Product data

IEC: 320 V / 17.5 A
UL: 300 V / 10 A

For additional articles and information, refer to catalog.weidmueller.com

Note:

- Gold-plated contact surfaces on request
- Rated current related to rated cross-section & min. No. of poles.
- Rated data refer only to the component itself. Clearance and creepage distances to other components are to be designed in accordance with the relevant application standards.
- P on drawing = pitch

SC-SMT 3.81../135G

closed side



Dimensioned drawing

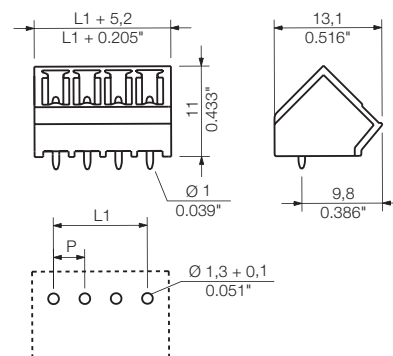

Accessories

Note: Refer to the Accessories chapter for additional accessories.

Coding		Order No.
	SC-SMT 3.81 KO GR	1968900000

Ordering data

Solder pin length	1.5 mm		3.2 mm		
	Black		Black		
Pitch 3.81 mm					
Pol.	L1	(inch)	Qty.	Order No.	Order No.
2	3.81	0.150	50	1977930000	1977200000
3	7.62	0.300	50	1977940000	1977210000
4	11.43	0.450	50	1977950000	1977220000
5	15.24	0.600	50	1977960000	1977230000
6	19.05	0.750	50	1977970000	1977240000
7	22.86	0.900	50	1977980000	1977250000
8	26.67	1.050	50	1977990000	1977690000
9	30.48	1.200	50	1978000000	1977700000
10	34.29	1.350	50	1978010000	1977710000
11	38.10	1.500	50	1978020000	1977720000
12	41.91	1.650	50	1978030000	1977730000
13	45.72	1.800	50	1978040000	1977740000
14	49.53	1.950	50	1978050000	1977750000
15	53.34	2.100	50	1978060000	1977760000
16	57.15	2.250	50	1978070000	1977770000

SC-SMT 3.81/./135LF

with solder flange



Dimensioned drawing

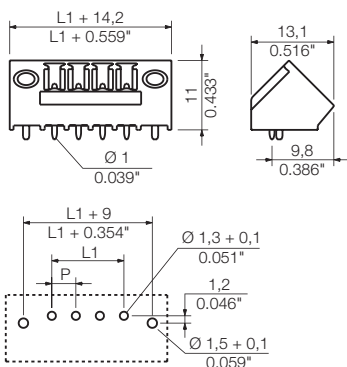

Ordering data

Solder pin length		1.5 mm	3.2 mm		
Colour		Black	Black		
Pitch		3.81 mm			
Pol.	L1 (mm)	L1 (inch)	Qty.	Order No.	Order No.
2	3.81	0.150	50	1978380000	1978080000
3	7.62	0.300	50	1978390000	1978090000
4	11.43	0.450	50	1978400000	1978100000
5	15.24	0.600	50	1978410000	1978110000
6	19.05	0.750	50	1978420000	1978120000
7	22.86	0.900	50	1978430000	1978130000
8	26.67	1.050	50	1978440000	1978140000
9	30.48	1.200	50	1978450000	1978150000
10	34.29	1.350	50	1978460000	1978160000
11	38.10	1.500	50	1978470000	1978170000
12	41.91	1.650	50	1978480000	1978180000
13	45.72	1.800	50	1978490000	1978190000
14	49.53	1.950	50	1978500000	1978200000
15	53.34	2.100	50	1978510000	1978210000
16	57.15	2.250	50	1978520000	1978220000

SC-SMT 3.81../270

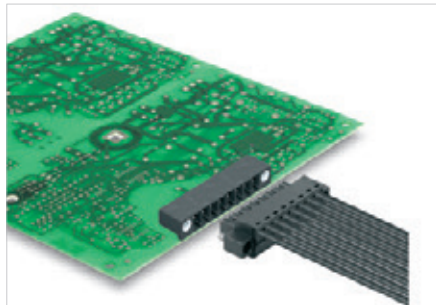

High-temperature-resistant male header with 270° plugging angle (the angle between the plugging direction and the solder pin). This angle has a plugging direction that is parallel to the circuit board with female plugs plugged in upside down.

- Reflow compatible
- Available in closed (G) version and with screw flange (F).
- Pin length of either 1.5 mm or 3.2 mm

Weidmüller's 3.81 mm pitch (0.15 inch) plug-in connectors are compatible with the layouts of standard connectors and offer space for labelling and coding.

Technical data

In compliance with IEC 60664-1 / IEC 61984			
Clamping range, max.	mm ²		
Solid core H05(07) V-U	mm ²		
Stranded H07 V-R			
Flexible H05(07) V-K	mm ²		
Flexible with ferrule	mm ²		
Ferrule with plastic collar	mm ²		
Stripping length	mm		
Screwdriver blade	mm		
According to norm			
Tightening torque range	Nm		
Rated current, max.	A	17.5	17.5
At ambient temperature		20°C	40°C
For conductor cross-section	mm ²		
Overvoltage category		III	III II
Pollution severity		3	2 2
Rated voltage	V	160	160 320
Rated impulse voltage	kV	2.5	2.5 2.5
UL / CUL (Use Group)		B	C D
Rated voltage	V	300	300
Rated current	A	10	10
AWG conductor	AWG		-
CSA (Use Group)		B	C D
Rated voltage	V	300	300
Rated current	A	10	10
AWG conductor	AWG		-
General data			
Type of insulation material		LCP GF	
UL 94 flammability rating		V-0	
Contact base material		Copper alloy	
Material of contact surface		tinned	
Pin dimensions = d	mm	1.0, Octagonal	
Solder eyelet Ø = D	mm	1.3	
Solder eyelet Ø tolerance	mm	+ 0,1	

Product data

IEC: 320 V / 17.5 A
UL: 300 V / 10 A

For additional articles and information, refer to catalog.weidmueller.com

Note:

- Gold-plated contact surfaces on request
- Rated current related to rated cross-section & min. No. of poles.
- Rated data refer only to the component itself. Clearance and creepage distances to other components are to be designed in accordance with the relevant application standards.
- P on drawing = pitch

SC-SMT 3.81../270G

closed side



Dimensioned drawing

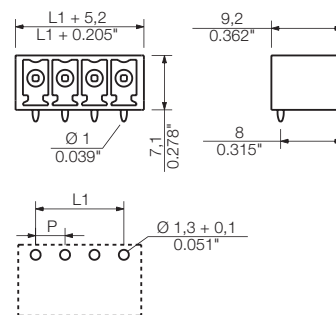

Accessories

Note: Refer to the Accessories chapter for additional accessories.

Coding		Order No.
	SC-SMT 3.81 KO GR	1968900000

Ordering data

Solder pin length		1.5 mm	3.2 mm	
Colour		Black	Black	
Pitch 3.81 mm				
Pol.	L1 (inch)	Qty.	Order No.	Order No.
2	3.81 0.150	50	1036830000	1036480000
3	7.62 0.300	50	1036840000	1036490000
4	11.43 0.450	50	1036850000	1036510000
5	15.24 0.600	50	1036860000	1036520000
6	19.05 0.750	50	1036870000	1036530000
7	22.86 0.900	50	1036880000	1036540000
8	26.67 1.050	50	1036890000	1036550000
9	30.48 1.200	50	1036910000	1036560000
10	34.29 1.350	50	1036920000	1036570000
11	38.10 1.500	50	1036930000	1036580000
12	41.91 1.650	50	1036940000	1036590000
13	45.72 1.800	50	1036950000	1036610000
14	49.53 1.950	50	1036960000	1036620000
15	53.34 2.100	50	1036970000	1036630000
16	57.15 2.250	50	1036980000	1036640000

SC-SMT 3.81/./270F

with screw flange



Dimensioned drawing

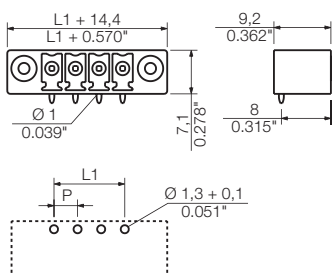

Ordering data

Solder pin length		1.5 mm	3.2 mm	
Colour		Black	Black	
Pitch		3.81 mm		
Pol.	L1 (inch)	Qty.	Order No.	Order No.
2	3.81 0.150	50	1037330000	1036990000
3	7.62 0.300	50	1037340000	1037010000
4	11.43 0.450	50	1037350000	1037020000
5	15.24 0.600	50	1037360000	1037030000
6	19.05 0.750	50	1037370000	1037040000
7	22.86 0.900	50	1037380000	1037050000
8	26.67 1.050	50	1037390000	1037060000
9	30.48 1.200	50	1037400000	1037070000
10	34.29 1.350	50	1037410000	1037080000
11	38.10 1.500	50	1037420000	1037090000
12	41.91 1.650	50	1037440000	1037110000
13	45.72 1.800	50	1037450000	1037120000
14	49.53 1.950	50	1037460000	1037130000
15	53.34 2.100	50	1037470000	1037140000
16	57.15 2.250	50	1037480000	1037150000

SCD-THR 3.81/./90

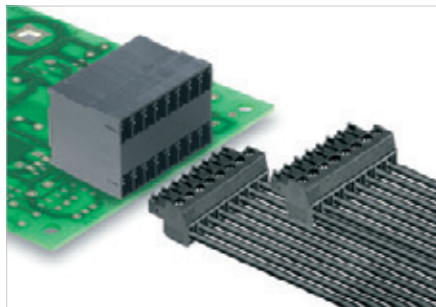

High-temperature-resistant, double-level male header for reflow soldering.

- Orientation: 90°
- Designed for front panel applications.
- Available in closed (G) version and with screw flange (F).

Weidmüller's 3.81 mm pitch (0.15 inch) plug-in connectors are compatible with the layouts of standard connectors and offer space for labelling and coding.

Technical data

In compliance with IEC 60664-1 / IEC 61984			
Clamping range, max.	mm ²		
Solid core H05(07) V-U	mm²		
Stranded H07 V-R			
Flexible H05(07) V-K	mm ²		
Flexible with ferrule	mm ²		
Ferrule with plastic collar	mm ²		
Stripping length	mm		
Screwdriver blade	mm		
According to norm			
Tightening torque range	Nm		
Rated current, max.	A	17.5	17
At ambient temperature		20°C	40°C
For conductor cross-section	mm ²		
Overvoltage category		III	III II
Pollution severity		3	2 2
Rated voltage	V	160	160 320
Rated impulse voltage	kV	2.5	2.5 2.5
UL / CUL (Use Group)	B C D		
Rated voltage	V	300	300
Rated current	A	10	10
AWG conductor	AWG		-
CSA (Use Group)	B C D		
Rated voltage	V	300	300
Rated current	A	10	10
AWG conductor	AWG		-
General data			
Type of insulation material		LCP GF	
UL 94 flammability rating		V-0	
Contact base material		Copper alloy	
Material of contact surface		tinned	
Pin dimensions = d	mm	1.0, Octagonal	
Solder eyelet Ø = D	mm	1.3	
Solder eyelet Ø tolerance	mm	+ 0,1	

Product data

IEC: 320 V / 17.5 A
UL: 300 V / 10 A

For additional articles and information, refer to catalog.weidmueller.com

Note:

- Gold-plated contact surfaces on request
- Rated current related to rated cross-section & min. No. of poles.
- Rated data refer only to the component itself. Clearance and creepage distances to other components are to be designed in accordance with the relevant application standards.
- P on drawing = pitch

SCD-THR 3.81/./90G

closed side



Dimensioned drawing

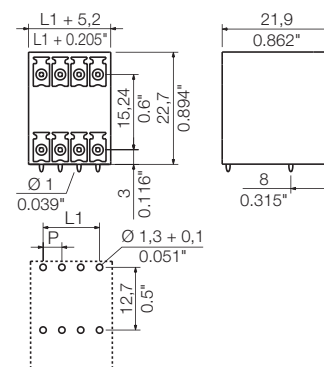

Accessories

Note: Refer to the Accessories chapter for additional accessories.

Coding		Order No.
	SC-SMT 3.81 KO GR	1968900000

Ordering data

Solder pin length	1.5 mm		3.2 mm		
	Black		Black		
Pitch	3.81 mm				
Pol.	L1	(inch)	Qty.	Order No.	Order No.
4	3.81	0.150	50	1974030000	1973730000
6	7.62	0.300	50	1974040000	1973740000
8	11.43	0.450	50	1974050000	1973750000
10	15.24	0.600	50	1974060000	1973760000
12	19.05	0.750	50	1974070000	1973770000
14	22.86	0.900	50	1974080000	1973780000
16	26.67	1.050	50	1974090000	1973790000
18	30.48	1.200	50	1974100000	1973800000
20	34.29	1.350	50	1974110000	1973810000
22	38.10	1.500	50	1974120000	1973820000
24	41.91	1.650	50	1974130000	1973830000
26	45.72	1.800	20	1974140000	1973840000
28	49.53	1.950	20	1974150000	1973850000
30	53.34	2.100	20	1974160000	1973860000
32	57.15	2.250	20	1974170000	1973870000

SCD-THR 3.81../90F

with screw flange



Dimensioned drawing

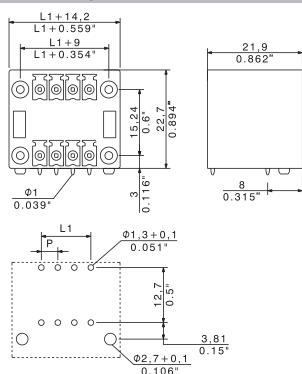

Ordering data

Solder pin length		1.5 mm	3.2 mm		
Colour		Black	Black		
Pitch		3.81 mm			
Pol.	L1 (inch)	Qty.	Order No.	Order No.	
4	3.81	0.150	50	1974830000	1974180000
6	7.62	0.300	50	1974870000	1974190000
8	11.43	0.450	50	1974900000	1974200000
10	15.24	0.600	50	1974920000	1974210000
12	19.05	0.750	50	1974950000	1974220000
14	22.86	0.900	50	1974980000	1974230000
16	26.67	1.050	50	1974990000	1974240000
18	30.48	1.200	50	1975010000	1974250000
20	34.29	1.350	50	1975040000	1974290000
22	38.10	1.500	50	1975090000	1974310000
24	41.91	1.650	50	1975110000	1974330000
26	45.72	1.800	20	1975130000	1974350000
28	49.53	1.950	20	1975140000	1974440000
30	53.34	2.100	20	1975170000	1974470000
32	57.15	2.250	20	1975190000	1974490000

SCD-THR 3.81../180

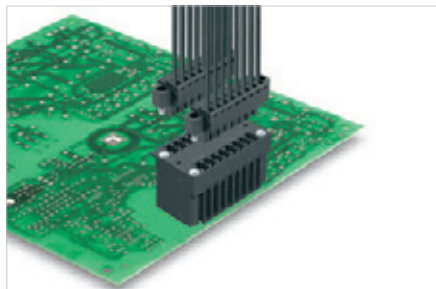

High-temperature-resistant, double-level male header for reflow soldering.

- It allows you to use two interfaces on only one surface and with only one step in the work flow.
- Outlet direction: 180° (recumbent)
- Connections at the same level and with access that is flush over the front board.
- Space for labelling and coding
- Packed in cardboard box.

Weidmüller's 3.81 mm pitch (0.15 inch) plug-in connectors are compatible with the layouts of standard connectors and offer space for labelling and coding.

Technical data

In compliance with IEC 60664-1 / IEC 61984			
Clamping range, max.	mm ²		
Solid core H05(07) V-U	mm²		
Stranded H07 V-R			
Flexible H05(07) V-K	mm ²		
Flexible with ferrule	mm ²		
Ferrule with plastic collar	mm ²		
Stripping length	mm		
Screwdriver blade	mm		
According to norm			
Tightening torque range	Nm		
Rated current, max.	A	17.5	17
At ambient temperature		20°C	40°C
For conductor cross-section	mm ²		
Overvoltage category		III	III II
Pollution severity		3	2 2
Rated voltage	V	160	160 320
Rated impulse voltage	kV	2.5	2.5 2.5
UL / CUL (Use Group)		B	C D
Rated voltage	V	300	300
Rated current	A	10	10
AWG conductor	AWG		-
CSA (Use Group)		B	C D
Rated voltage	V	300	300
Rated current	A	10	10
AWG conductor	AWG		-
General data			
Type of insulation material		LCP GF	
UL 94 flammability rating		V-0	
Contact base material		Copper alloy	
Material of contact surface		tinned	
Pin dimensions = d	mm	1.0, Octagonal	
Solder eyelet Ø = D	mm	1.3	
Solder eyelet Ø tolerance	mm	+ 0,1	

Product data

IEC: 320 V / 17.5 A
UL: 300 V / 10 A

For additional articles and information, refer to catalog.weidmueller.com

Note:

- Gold-plated contact surfaces on request
- Rated current related to rated cross-section & min. No. of poles.
- Rated data refer only to the component itself. Clearance and creepage distances to other components are to be designed in accordance with the relevant application standards.
- P on drawing = pitch

SCD-THR 3.81../180G

closed side



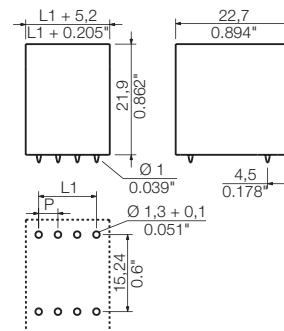

Dimensioned drawing



Accessories

Note: Refer to the Accessories chapter for additional accessories.

Coding		Order No.
	SC-SMT 3.81 KO GR	1968900000
	PTSC KA 2.2X4.5 WN1412	1610740000

Ordering data

Solder pin length	1.5 mm		3.2 mm		
	Black		Black		
Pitch	3.81 mm				
Pol.	L1	(inch)	Qty.	Order No.	Order No.
4	3.81	0.150	50	1031290000	1030950000
6	7.62	0.300	50	1031310000	1030960000
8	11.43	0.450	50	1031320000	1030970000
10	15.24	0.600	50	1031330000	1030980000
12	19.05	0.750	50	1031340000	1030990000
14	22.86	0.900	50	1031350000	1031010000
16	26.67	1.050	50	1031360000	1031020000
18	30.48	1.200	50	1031370000	1031030000
20	34.29	1.350	50	1031380000	1031040000
22	38.10	1.500	50	1031390000	1031050000
24	41.91	1.650	50	1031410000	1031060000
26	45.72	1.800	20	1031420000	1031070000
28	49.53	1.950	20	1031430000	1031080000
30	53.34	2.100	20	1031440000	1031090000
32	57.15	2.250	20	1031450000	1031110000

SCD-THR 3.81../180F

with screw flange



Dimensioned drawing

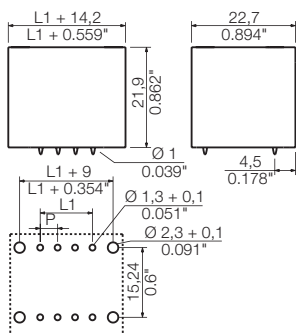

Ordering data

Solder pin length		1.5 mm	3.2 mm
Colour		Black	Black
Pitch		3.81 mm	
Pol.	L1 (inch)	Qty.	Order No.
4	3.81 0.150	50	1031860000 1031460000
6	7.62 0.300	50	1031870000 1031470000
8	11.43 0.450	50	1031890000 1031490000
10	15.24 0.600	50	1031910000 1031510000
12	19.05 0.750	50	1031920000 1031520000
14	22.86 0.900	50	1031930000 1031530000
16	26.67 1.050	50	1031940000 1031540000
18	30.48 1.200	50	1031950000 1031560000
20	34.29 1.350	50	1031960000 1031570000
22	38.10 1.500	50	1031970000 1031590000
24	41.91 1.650	50	1031990000 1031610000
26	45.72 1.800	20	1032040000 1031620000
28	49.53 1.950	20	1032050000 1031630000
30	53.34 2.100	20	1032060000 1031640000
32	57.15 2.250	20	1032070000 1031660000

SCDN-THR 3.81/./90

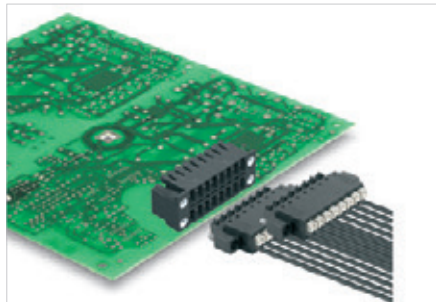

Compact double-level male header for reflow soldering process. For use with BCF 3.81 plugs.

- Orientation: 90°
- Designed for front panel applications.
- Available in closed (G) version and with screw flange (F).

Weidmüller's 3.81 mm pitch (0.15 inch) plug-in connectors are compatible with the layouts of standard connectors and offer space for labelling and coding.

Technical data

In compliance with IEC 60664-1 / IEC 61984			
Clamping range, max.	mm ²		
Solid core H05(07) V-U	mm²		
Stranded H07 V-R			
Flexible H05(07) V-K	mm ²		
Flexible with ferrule	mm ²		
Ferrule with plastic collar	mm ²		
Stripping length	mm		
Screwdriver blade	mm		
According to norm			
Tightening torque range	Nm		
Rated current, max.	A	17.5	17
At ambient temperature		20°C	40°C
For conductor cross-section	mm ²		
Overvoltage category		III	III II
Pollution severity		3	2 2
Rated voltage	V	160	160 320
Rated impulse voltage	kV	2.5	2.5 2.5
UL / CUL (Use Group)		B	C D
Rated voltage	V	300	300
Rated current	A	10	10
AWG conductor	AWG		-
CSA (Use Group)		B	C D
Rated voltage	V	300	300
Rated current	A	10	10
AWG conductor	AWG		-
General data			
Type of insulation material		LCP GF	
UL 94 flammability rating		V-0	
Contact base material		Copper alloy	
Material of contact surface		tinned	
Pin dimensions = d	mm	1.0, Octagonal	
Solder eyelet Ø = D	mm	1.3	
Solder eyelet Ø tolerance	mm	+ 0,1	

Product data

IEC: 320 V / 17.5 A
UL: 300 V / 10 A

For additional articles and information, refer to catalog.weidmueller.com

Note:

- Gold-plated contact surfaces on request
- Rated current related to rated cross-section & min. No. of poles.
- Rated data refer only to the component itself. Clearance and creepage distances to other components are to be designed in accordance with the relevant application standards.
- P on drawing = pitch

SCDN-THR 3.81/./90G

closed side



Dimensioned drawing

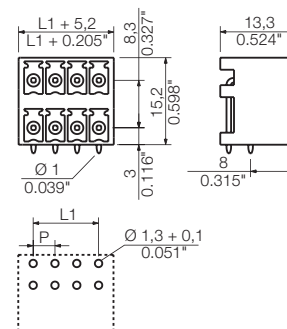

Accessories

Note: Refer to the Accessories chapter for additional accessories.

Coding		Order No.
	SC-SMT 3.81 KO GR	1968900000

Ordering data

Solder pin length	1.5 mm		3.2 mm		
	Black		Black		
Pitch	3.81 mm				
Pol.	L1	(inch)	Qty.	Order No.	Order No.
4	3.81	0.150	50	1039270000	1038950000
6	7.62	0.300	50	1039280000	1038960000
8	11.43	0.450	50	1039290000	1038970000
10	15.24	0.600	50	1039300000	1038980000
12	19.05	0.750	50	1039310000	1038990000
14	22.86	0.900	50	1039320000	1039010000
16	26.67	1.050	50	1039330000	1039020000
18	30.48	1.200	50	1039340000	1039030000
20	34.29	1.350	50	1039350000	1039040000
22	38.10	1.500	50	1039370000	1039050000
24	41.91	1.650	50	1039380000	1039060000
26	45.72	1.800	20	1039390000	1039070000
28	49.53	1.950	20	1039410000	1039080000
30	53.34	2.100	20	1039420000	1039090000
32	57.15	2.250	20	1039430000	1039100000

SCDN-THR 3.81/././90F

with screw flange



Dimensioned drawing

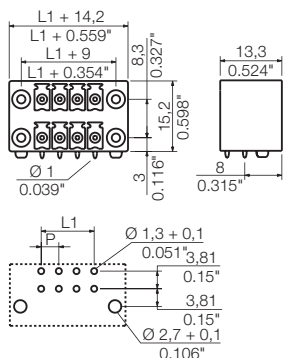

Ordering data

Solder pin length		1.5 mm	3.2 mm		
Colour		Black	Black		
Pitch		3.81 mm			
Pol.	L1	(inch)	Qty.	Order No.	Order No.
4	3.81	0.150	50	1040070000	1039440000
6	7.62	0.300	50	1040090000	1039450000
8	11.43	0.450	50	1040140000	1039460000
10	15.24	0.600	50	1040150000	1039520000
12	19.05	0.750	50	1040170000	1039530000
14	22.86	0.900	50	1040190000	1039540000
16	26.67	1.050	50	1040230000	1039550000
18	30.48	1.200	50	1040250000	1039560000
20	34.29	1.350	50	1040260000	1039570000
22	38.10	1.500	50	1040270000	1039580000
24	41.91	1.650	50	1040280000	1039590000
26	45.72	1.800	20	1040290000	1039610000
28	49.53	1.950	20	1040300000	1039720000
30	53.34	2.100	20	1040380000	1039730000
32	57.15	2.250	20	1040390000	1039740000

SCDV-THR 3.81/.. /90

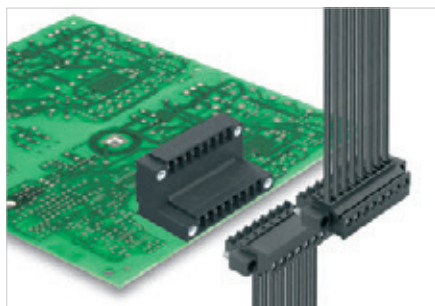

High-temperature-resistant, double-level male header for reflow soldering.

- Orientation: 90°
- Connections at two offset levels and open access to each row.
- Available in closed (G) version and with screw flange (F).

Weidmüller's 3.81 mm pitch (0.15 inch) plug-in connectors are compatible with the layouts of standard connectors and offer space for labelling and coding.

Technical data

In compliance with IEC 60664-1 / IEC 61984			
Clamping range, max.	mm ²		
Solid core H05(07) V-U	mm²		
Stranded H07 V-R			
Flexible H05(07) V-K	mm ²		
Flexible with ferrule	mm ²		
Ferrule with plastic collar	mm ²		
Stripping length	mm		
Screwdriver blade	mm		
According to norm			
Tightening torque range	Nm		
Rated current, max.	A	17.5	17
At ambient temperature		20°C	40°C
For conductor cross-section	mm ²		
Overvoltage category		III	III II
Pollution severity		3	2 2
Rated voltage	V	160	160 320
Rated impulse voltage	kV	2.5	2.5 2.5
UL / CUL (Use Group)		B	C D
Rated voltage	V	300	300
Rated current	A	10	10
AWG conductor	AWG		-
CSA (Use Group)		B	C D
Rated voltage	V	300	300
Rated current	A	10	10
AWG conductor	AWG		-
General data			
Type of insulation material		LCP GF	
UL 94 flammability rating		V-0	
Contact base material		Copper alloy	
Material of contact surface		tinned	
Pin dimensions = d	mm	1.0, Octagonal	
Solder eyelet Ø = D	mm	1.3	
Solder eyelet Ø tolerance	mm	+ 0,1	

Product data

IEC: 320 V / 17.5 A
UL: 300 V / 10 A

For additional articles and information, refer to catalog.weidmueller.com

Note:

- Gold-plated contact surfaces on request
- Rated current related to rated cross-section & min. No. of poles.
- Rated data refer only to the component itself. Clearance and creepage distances to other components are to be designed in accordance with the relevant application standards.
- P on drawing = pitch

SCDV-THR 3.81/.. /90G

closed side



Dimensioned drawing

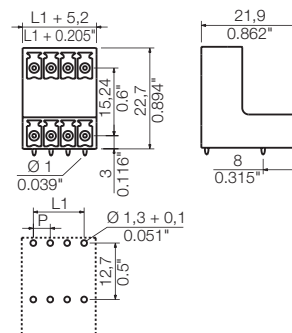

Accessories

Note: Refer to the Accessories chapter for additional accessories.

Coding		Order No.
	SC-SMT 3.81 KO GR	1968900000

Ordering data

Solder pin length	1.5 mm		3.2 mm		
	Black		Black		
Pitch	3.81 mm				
Pol.	L1	(inch)	Qty.	Order No.	Order No.
4	3.81	0.150	50	1033820000	1033490000
6	7.62	0.300	50	1033830000	1033510000
8	11.43	0.450	50	1033840000	1033520000
10	15.24	0.600	50	1033850000	1033530000
12	19.05	0.750	50	1033860000	1033540000
14	22.86	0.900	50	1033870000	1033550000
16	26.67	1.050	50	1033880000	1033560000
18	30.48	1.200	50	1033890000	1033570000
20	34.29	1.350	50	1033900000	1033580000
22	38.10	1.500	50	1033910000	1033590000
24	41.91	1.650	50	1033920000	1033600000
26	45.72	1.800	20	1033930000	1033610000
28	49.53	1.950	20	1033940000	1033620000
30	53.34	2.100	20	1033950000	1033630000
32	57.15	2.250	20	1033960000	1033640000

SCDV-THR 3.81../90F

with screw flange



Dimensioned drawing

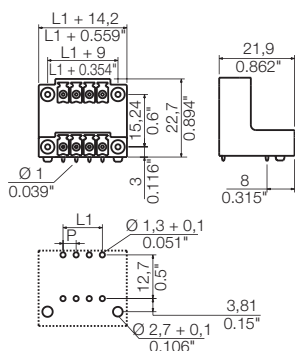

Ordering data

Solder pin length		1.5 mm	3.2 mm		
Colour		Black	Black		
Pitch		3.81 mm			
Pol.	L1	(inch)	Qty.	Order No.	Order No.
4	3.81	0.150	50	1034310000	1033970000
6	7.62	0.300	50	1034320000	1033980000
8	11.43	0.450	50	1034330000	1033990000
10	15.24	0.600	50	1034340000	1034010000
12	19.05	0.750	50	1034350000	1034020000
14	22.86	0.900	50	1034360000	1034030000
16	26.67	1.050	50	1034370000	1034040000
18	30.48	1.200	50	1034380000	1034050000
20	34.29	1.350	50	1034390000	1034060000
22	38.10	1.500	50	1034410000	1034070000
24	41.91	1.650	50	1034420000	1034080000
26	45.72	1.800	20	1034430000	1034090000
28	49.53	1.950	20	1034440000	1034110000
30	53.34	2.100	20	1034450000	1034120000
32	57.15	2.250	20	1034460000	1034130000

SCDV-THR 3.81/./180

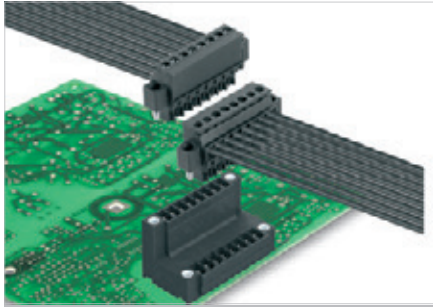

High-temperature-resistant, double-level male header for reflow soldering.

- Outlet direction: 180°
- Connections at two offset levels and open access to each row.
- Available in closed (G) version and with screw flange (F).

Weidmüller's 3.81 mm pitch (0.15 inch) plug-in connectors are compatible with the layouts of standard connectors and offer space for labelling and coding.

Technical data

In compliance with IEC 60664-1 / IEC 61984			
Clamping range, max.	mm ²		
Solid core H05(07) V-U	mm²		
Stranded H07 V-R			
Flexible H05(07) V-K	mm ²		
Flexible with ferrule	mm ²		
Ferrule with plastic collar	mm ²		
Stripping length	mm		
Screwdriver blade	mm		
According to norm			
Tightening torque range	Nm		
Rated current, max.	A	17.5	17
At ambient temperature		20°C	40°C
For conductor cross-section	mm ²		
Overvoltage category		III	III II
Pollution severity		3	2 2
Rated voltage	V	160	160 320
Rated impulse voltage	kV	2.5	2.5 2.5
UL / CUL (Use Group)		B	C D
Rated voltage	V	300	300
Rated current	A	10	10
AWG conductor	AWG		-
CSA (Use Group)		B	C D
Rated voltage	V	300	300
Rated current	A	10	10
AWG conductor	AWG		-
General data			
Type of insulation material		LCP GF	
UL 94 flammability rating		V-0	
Contact base material		Copper alloy	
Material of contact surface		tinned	
Pin dimensions = d	mm	1.0, Octagonal	
Solder eyelet Ø = D	mm	1.3	
Solder eyelet Ø tolerance	mm	+ 0,1	

Product data

IEC: 320 V / 17.5 A
UL: 300 V / 10 A

For additional articles and information, refer to catalog.weidmueller.com

Note:

- Gold-plated contact surfaces on request
- Rated current related to rated cross-section & min. No. of poles.
- Rated data refer only to the component itself. Clearance and creepage distances to other components are to be designed in accordance with the relevant application standards.
- P on drawing = pitch

SCDV-THR 3.81/./180G

closed side



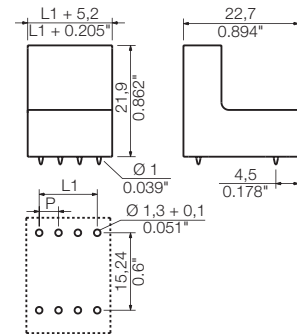

Dimensioned drawing



Accessories

Note: Refer to the Accessories chapter for additional accessories.

Coding		Order No.
	SC-SMT 3.81 KO GR	1968900000
	PTSC KA 2.2X4.5 WN1412	1610740000

Ordering data

Pitch	Solder pin length		1.5 mm		3.2 mm	
	Colour		Black	Black	Black	Black
Pitch 3.81 mm						
Pol.	L1	(inch)	Qty.	Order No.	Order No.	
4	3.81	0.150	50	1035790000	1035470000	
6	7.62	0.300	50	1035800000	1035480000	
8	11.43	0.450	50	1035810000	1035490000	
10	15.24	0.600	50	1035820000	1035510000	
12	19.05	0.750	50	1035830000	1035520000	
14	22.86	0.900	50	1035840000	1035530000	
16	26.67	1.050	50	1035850000	1035540000	
18	30.48	1.200	50	1035860000	1035550000	
20	34.29	1.350	50	1035870000	1035560000	
22	38.10	1.500	50	1035880000	1035570000	
24	41.91	1.650	50	1035890000	1035580000	
26	45.72	1.800	20	1035910000	1035590000	
28	49.53	1.950	20	1035920000	1035610000	
30	53.34	2.100	20	1035930000	1035620000	
32	57.15	2.250	20	1035940000	1035630000	

SCDV-THR 3.81../180F

with screw flange



Dimensioned drawing

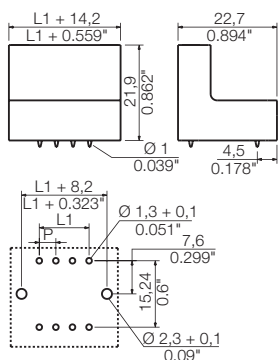

Ordering data

Solder pin length		1.5 mm	3.2 mm		
Colour		Black	Black		
Pitch		3.81 mm			
Pol.	L1	(inch)	Qty.	Order No.	Order No.
4	3.81	0.150	50	1036320000	1035950000
6	7.62	0.300	50	1036330000	1035960000
8	11.43	0.450	50	1036340000	1035970000
10	15.24	0.600	50	1036350000	1035980000
12	19.05	0.750	50	1036360000	1035990000
14	22.86	0.900	50	1036370000	1036010000
16	26.67	1.050	50	1036380000	1036020000
18	30.48	1.200	50	1036390000	1036030000
20	34.29	1.350	50	1036410000	1036040000
22	38.10	1.500	50	1036420000	1036050000
24	41.91	1.650	50	1036430000	1036060000
26	45.72	1.800	20	1036440000	1036070000
28	49.53	1.950	20	1036450000	1036080000
30	53.34	2.100	20	1036460000	1036090000
32	57.15	2.250	20	1036470000	1036110000

SC 3.81/././90

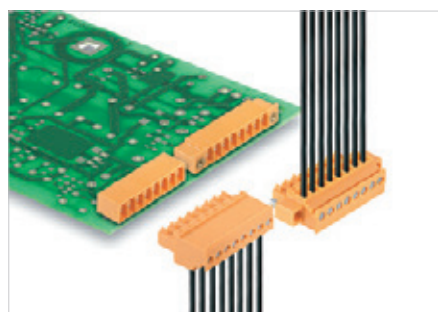

Male header with plugging direction in parallel to the circuit board.

- Available in closed (G) version and with screw flange (F)

Weidmüller's 3.81 mm pitch (0.15 inch) plug-in connectors are compatible with the layouts of standard connectors. They support a flood-light display and offer space for labelling and coding.

Technical data

In compliance with IEC 60664-1 / IEC 61984			
Clamping range, max.	mm ²		
Solid core H05(07) V-U	mm²		
Stranded H07 V-R			
Flexible H05(07) V-K	mm ²		
Flexible with ferrule	mm ²		
Ferrule with plastic collar	mm ²		
Stripping length	mm		
Screwdriver blade	mm		
According to norm			
Tightening torque range	Nm		
Rated current, max.	A	17.5	17.5
At ambient temperature		20°C	40°C
For conductor cross-section	mm ²		
Overvoltage category		III	III II
Pollution severity		3	2 2
Rated voltage	V	160	160 320
Rated impulse voltage	kV	2.5	2.5 2.5
UL / CUL (Use Group)		B	C D
Rated voltage	V	300	300
Rated current	A	10	10
AWG conductor	AWG		
CSA (Use Group)		B	C D
Rated voltage	V	300	300
Rated current	A	10	10
AWG conductor	AWG		
General data			
Type of insulation material		PA GF	
UL 94 flammability rating		V-0	
Contact base material		Copper alloy	
Material of contact surface		tinned	
Pin dimensions = d	mm	1.0, Octagonal	
Solder eyelet Ø = D	mm	1.2	
Solder eyelet Ø tolerance	mm	+ 0,1	

Product data

IEC: 320 V / 17.5 A
UL: 300 V / 10 A

For additional articles and information, refer to catalog.weidmueller.com

Note:

- Additional colours on request
- Gold-plated contact surfaces on request
- Rated current related to rated cross-section & min. No. of poles.
- Rated data refer only to the component itself. Clearance and creepage distances to other components are to be designed in accordance with the relevant application standards.
- P on drawing = pitch

SC 3.81/././90G

closed side

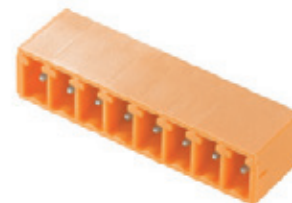

Dimensioned drawing

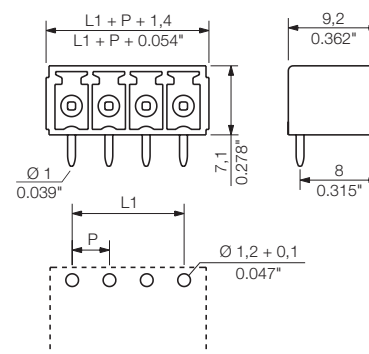

Accessories

Note: Refer to the Accessories chapter for additional accessories.

Coding	Order No.
SC-SMT 3.81 KO GR	1968900000
LED light guide	
SC 3.81 FLA 1.5/14.25	1979730000
SC 3.81 FLA 1.5/16	1979720000
SC 3.81 FLA 2.3/14.25	1979750000
SC 3.81 FLA 2.3/16	1979740000

Ordering data

Solder pin length	3.2 mm	3.2 mm			
Colour	Orange	Black			
Pitch 3.81 mm					
Pol.	L1 (inch)	Qty.	Order No.	Order No.	
2	3.81	0.150	50	1942020000	1793130000
3	7.62	0.300	50	1942040000	1793140000
4	11.43	0.450	50	1942070000	1793150000
5	15.24	0.600	50	1942090000	1793160000
6	19.05	0.750	50	1942100000	1793170000
7	22.86	0.900	50	1942120000	1942350000
8	26.67	1.050	50	1942130000	1793180000
9	30.48	1.200	50	1942140000	1942360000
10	34.29	1.350	50	1942150000	1793190000
11	38.10	1.500	50	1942160000	1942370000
12	41.91	1.650	50	1942170000	1793200000
13	45.72	1.800	50	1942180000	1942380000
14	49.53	1.950	50	1942190000	1942390000
15	53.34	2.100	50	1942200000	1942400000
16	57.15	2.250	50	1942210000	1793210000
17	60.96	2.400	50	1942220000	1942410000
18	64.77	2.550	50	1942230000	1942420000
19	68.58	2.700	50	1942240000	1942430000
20	72.39	2.850	50	1942250000	1942440000

SC 3.81/.. /90F

with screw flange



Dimensioned drawing

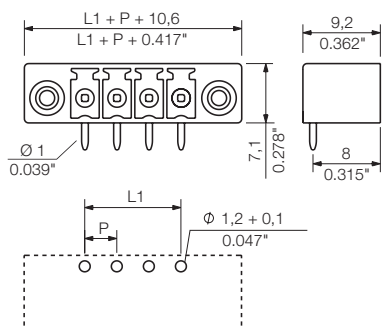

Ordering data

Solder pin length		3.2 mm	3.2 mm
Colour		Orange	Black
Pitch		3.81 mm	
Pol.	L1 (inch)	Qty.	Order No.
2	3.81 0.150	50	1942450000 1793330000
3	7.62 0.300	50	1942460000 1793340000
4	11.43 0.450	50	1942470000 1793350000
5	15.24 0.600	50	1942480000 1793360000
6	19.05 0.750	50	1942490000 1793370000
7	22.86 0.900	50	1942500000 1942740000
8	26.67 1.050	50	1942510000 1793380000
9	30.48 1.200	50	1942520000 1942750000
10	34.29 1.350	50	1942530000 1793390000
11	38.10 1.500	50	1942540000 1942760000
12	41.91 1.650	50	1942550000 1793400000
13	45.72 1.800	50	1942560000 1942770000
14	49.53 1.950	50	1942570000 1942780000
15	53.34 2.100	50	1942580000 1942790000
16	57.15 2.250	50	1942590000 1793410000
17	60.96 2.400	50	1942600000 1942800000
18	64.77 2.550	50	1942610000 1942810000
19	68.58 2.700	50	1942620000 1942820000
20	72.39 2.850	50	1942630000 1942830000

SC 3.81../180

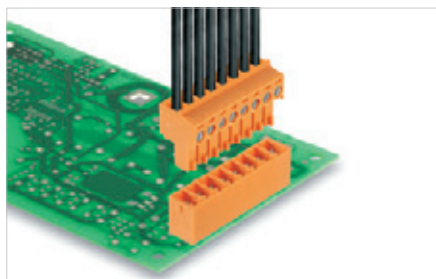

The 180° male header has a perpendicular plugging direction in relation to the circuit board. It is available in closed (G) and screw flange (F) versions.

Weidmüller's 3.81 mm pitch (0.15 inch) plug-in connectors are compatible with the layouts of standard connectors and offer space for labelling and coding.

Product data

IEC: 320 V / 17.5 A
UL: 300 V / 10 A

For additional articles and information, refer to catalog.weidmueller.com

Note:

- Additional colours on request
- Gold-plated contact surfaces on request
- Rated current related to rated cross-section & min. No. of poles.
- Rated data refer only to the component itself. Clearance and creepage distances to other components are to be designed in accordance with the relevant application standards.
- P on drawing = pitch

SC 3.81../180G

closed side



Dimensioned drawing

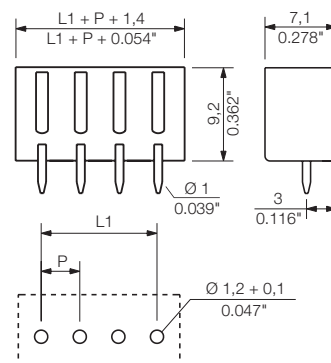

Technical data

In compliance with IEC 60664-1 / IEC 61984			
Clamping range, max.	mm ²		
Solid core H05(07) V-U	mm²		
Stranded H07 V-R			
Flexible H05(07) V-K	mm ²		
Flexible with ferrule	mm ²		
Ferrule with plastic collar	mm ²		
Stripping length	mm		
Screwdriver blade	mm		
According to norm			
Tightening torque range	Nm		
Rated current, max.	A	17.5	17.5
At ambient temperature		20°C	40°C
For conductor cross-section	mm ²		
Overvoltage category		III	III II
Pollution severity		3	2 2
Rated voltage	V	160	160 320
Rated impulse voltage	kV	2.5	2.5 2.5
UL / CUL (Use Group)		B	C D
Rated voltage	V	300	300
Rated current	A	10	10
AWG conductor	AWG		-
CSA (Use Group)		B	C D
Rated voltage	V	300	300
Rated current	A	10	10
AWG conductor	AWG		-
General data			
Type of insulation material		PA GF	
UL 94 flammability rating		V-0	
Contact base material		Copper alloy	
Material of contact surface		tinned	
Pin dimensions = d	mm	1.0, Octagonal	
Solder eyelet Ø = D	mm	1.2	
Solder eyelet Ø tolerance	mm	+ 0,1	

Accessories

Note: Refer to the Accessories chapter for additional accessories.

Coding		Order No.
	SC-SMT 3.81 KO GR	1968900000
Mounting screw		
	PTSC KA 2.2X4.5 WN1412	1610740000

Ordering data

Solder pin length	3.2 mm	3.2 mm			
Colour	Orange	Black			
Pitch	3.81 mm				
Pol.	L1 (inch)	Qty.	Order No.	Order No.	
2	3.81	0.150	50	1942840000	1793520000
3	7.62	0.300	50	1942850000	1793530000
4	11.43	0.450	50	1942860000	1793540000
5	15.24	0.600	50	1942870000	1793550000
6	19.05	0.750	50	1942880000	1793560000
7	22.86	0.900	50	1942890000	1871490000
8	26.67	1.050	50	1942900000	1793570000
9	30.48	1.200	50	1942910000	1871470000
10	34.29	1.350	50	1942920000	1793580000
11	38.10	1.500	50	1942930000	1943100000
12	41.91	1.650	50	1942940000	1793590000
13	45.72	1.800	50	1942950000	1943110000
14	49.53	1.950	50	1942960000	1943120000
15	53.34	2.100	50	1942970000	1943130000
16	57.15	2.250	50	1942980000	1793600000
17	60.96	2.400	50	1942990000	1943140000
18	64.77	2.550	50	1943000000	1943150000
19	68.58	2.700	50	1943010000	1943160000
20	72.39	2.850	50	1943020000	1943170000

SC 3.81/././180F

with screw flange



Dimensioned drawing

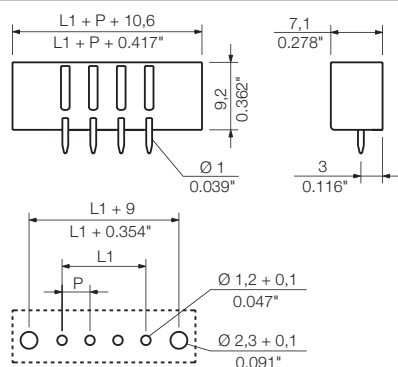

Ordering data

Solder pin length		3.2 mm	3.2 mm		
Colour		Orange	Black		
Pitch		3.81 mm			
Pol.	L1 (inch)	Qty.	Order No.	Order No.	
2	3.81	0.150	50	1943180000	1793700000
3	7.62	0.300	50	1943190000	1793710000
4	11.43	0.450	50	1943200000	1793720000
5	15.24	0.600	50	1943210000	1793730000
6	19.05	0.750	50	1943220000	1793740000
7	22.86	0.900	50	1943230000	1837010000
8	26.67	1.050	50	1943240000	1793750000
9	30.48	1.200	50	1943250000	1943470000
10	34.29	1.350	50	1943260000	1793760000
11	38.10	1.500	50	1943270000	1943480000
12	41.91	1.650	50	1943280000	1793770000
13	45.72	1.800	50	1943290000	1943490000
14	49.53	1.950	50	1943300000	1943500000
15	53.34	2.100	50	1943310000	1943510000
16	57.15	2.250	50	1943320000	1793780000
17	60.96	2.400	50	1943330000	1943520000
18	64.77	2.550	50	1943340000	1943530000
19	68.58	2.700	50	1943350000	1943540000
20	72.39	2.850	50	1943360000	1943550000

SC 3.81../135

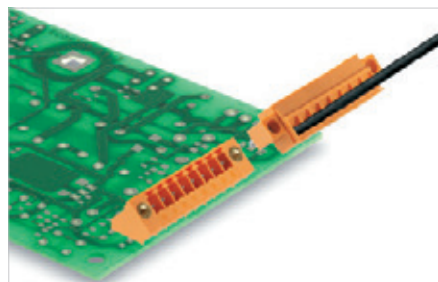

Male header with 135° plugging angle – (135° angle between the plugging direction and the solder pin). This corresponds to a 45° angle between the wire outlet and the circuit board.

- Available in Closed (G) version and with screw flange (F).

Weidmüller's 3.81 mm pitch (0.15 inch) plug-in connectors are compatible with the layouts of standard connectors and offer space for labelling and coding.

Technical data

In compliance with IEC 60664-1 / IEC 61984			
Clamping range, max.	mm ²		
Solid core H05(07) V-U	mm²		
Stranded H07 V-R			
Flexible H05(07) V-K	mm ²		
Flexible with ferrule	mm ²		
Ferrule with plastic collar	mm ²		
Stripping length	mm		
Screwdriver blade	mm		
According to norm			
Tightening torque range	Nm		
Rated current, max.	A	17.5	17.5
At ambient temperature		20°C	40°C
For conductor cross-section	mm ²		
Overvoltage category		III	III II
Pollution severity		3	2 2
Rated voltage	V	160	160 320
Rated impulse voltage	kV	2.5	2.5 2.5
UL / CUL (Use Group)		B	C D
Rated voltage	V	300	300
Rated current	A	10	10
AWG conductor	AWG		-
CSA (Use Group)		B	C D
Rated voltage	V	300	300
Rated current	A	10	10
AWG conductor	AWG		-
General data			
Type of insulation material		PA GF	
UL 94 flammability rating		V-0	
Contact base material		Copper alloy	
Material of contact surface		tinned	
Pin dimensions = d	mm	1.0, Octagonal	
Solder eyelet Ø = D	mm	1.2	
Solder eyelet Ø tolerance	mm	+ 0,1	

Product data

IEC: 320 V / 17.5 A
UL: 300 V / 10 A

For additional articles and information, refer to catalog.weidmueller.com

Note:

- Additional colours on request
- Gold-plated contact surfaces on request
- Rated current related to rated cross-section & min. No. of poles.
- Rated data refer only to the component itself. Clearance and creepage distances to other components are to be designed in accordance with the relevant application standards.
- P on drawing = pitch

SC 3.81../135G

closed side



Dimensioned drawing

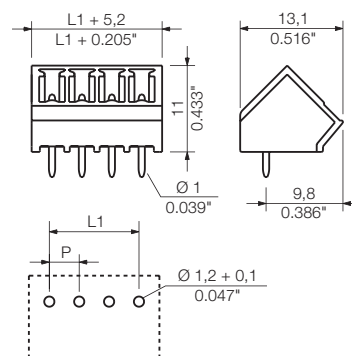

Accessories

Note: Refer to the Accessories chapter for additional accessories.

Coding		Order No.
	SC-SMT 3.81 KO GR	1968900000

Ordering data

Solder pin length		3.2 mm	3.2 mm		
Colour		Orange	Black		
Pitch 3.81 mm					
Pol.	L1 (inch)	Qty.	Order No.	Order No.	
2	3.81	0.150	50	1975720000	1976380000
3	7.62	0.300	50	1975770000	1976400000
4	11.43	0.450	50	1975800000	1976420000
5	15.24	0.600	50	1975810000	1976450000
6	19.05	0.750	50	1975880000	1976460000
7	22.86	0.900	50	1975900000	1976510000
8	26.67	1.050	50	1975920000	1976540000
9	30.48	1.200	50	1975930000	1976560000
10	34.29	1.350	50	1975940000	1976600000
11	38.10	1.500	50	1975950000	1976630000
12	41.91	1.650	50	1975960000	1976660000
13	45.72	1.800	50	1975970000	1976700000
14	49.53	1.950	50	1975980000	1976710000
15	53.34	2.100	50	1975990000	1976720000
16	57.15	2.250	50	1976000000	1976730000

SC 3.81/././135F

with screw flange



Dimensioned drawing

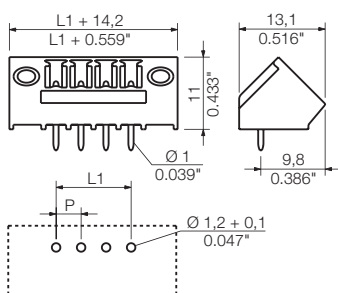

Ordering data

Solder pin length		3.2 mm	3.2 mm
Colour		Orange	Black
Pitch		3.81 mm	
Pol.	L1 (inch)	Qty.	Order No.
2	3.81 0.150	50	1976740000 1977040000
3	7.62 0.300	50	1976750000 1977050000
4	11.43 0.450	50	1976760000 1977060000
5	15.24 0.600	50	1976770000 1977070000
6	19.05 0.750	50	1976780000 1977080000
7	22.86 0.900	50	1976790000 1977090000
8	26.67 1.050	50	1976800000 1977100000
9	30.48 1.200	50	1976810000 1977110000
10	34.29 1.350	50	1976820000 1977120000
11	38.10 1.500	50	1976830000 1977130000
12	41.91 1.650	50	1976840000 1977140000
13	45.72 1.800	50	1976850000 1977150000
14	49.53 1.950	50	1976860000 1977160000
15	53.34 2.100	50	1976870000 1977170000
16	57.15 2.250	50	1976880000 1977180000

SC 3.81../270

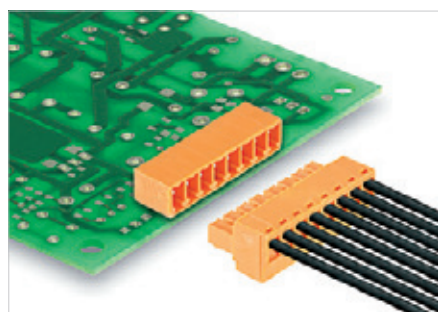

Male header with 270° plugging angle (270° angle between the plugging direction and the solder pin). This angle has a plugging direction that is parallel to the circuit board with female plugs plugged in upside down.

- Available in closed (G) version and with screw flange (F).

Weidmüller's 3.81 mm pitch (0.15 inch) plug-in connectors are compatible with the layouts of standard connectors and offer space for labelling and coding.

Technical data

In compliance with IEC 60664-1 / IEC 61984			
Clamping range, max.	mm ²		
Solid core H05(07) V-U	mm²		
Stranded H07 V-R			
Flexible H05(07) V-K	mm ²		
Flexible with ferrule	mm ²		
Ferrule with plastic collar	mm ²		
Stripping length	mm		
Screwdriver blade	mm		
According to norm			
Tightening torque range	Nm		
Rated current, max.	A	17.5	17.5
At ambient temperature		20°C	40°C
For conductor cross-section	mm ²		
Overtolerance category		III	III II
Pollution severity		3	2 2
Rated voltage	V	160	160 320
Rated impulse voltage	kV	2.5	2.5 2.5
UL / CUL (Use Group)		B	C D
Rated voltage	V	300	300
Rated current	A	10	10
AWG conductor	AWG		-
CSA (Use Group)		B	C D
Rated voltage	V	300	300
Rated current	A	10	10
AWG conductor	AWG		-
General data			
Type of insulation material		PA GF	
UL 94 flammability rating		V-0	
Contact base material		Copper alloy	
Material of contact surface		tinned	
Pin dimensions = d	mm	1.0, Octagonal	
Solder eyelet Ø = D	mm	1.2	
Solder eyelet Ø tolerance	mm	+ 0,1	

Product data

IEC: 320 V / 17.5 A
UL: 300 V / 10 A

For additional articles and information, refer to catalog.weidmueller.com

Note:

- Additional colours on request
- Gold-plated contact surfaces on request
- Rated current related to rated cross-section & min. No. of poles.
- Rated data refer only to the component itself. Clearance and creepage distances to other components are to be designed in accordance with the relevant application standards.
- P on drawing = pitch

SC 3.81../270G

closed side

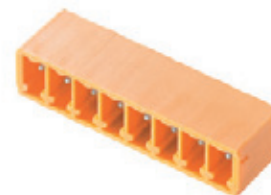

Dimensioned drawing

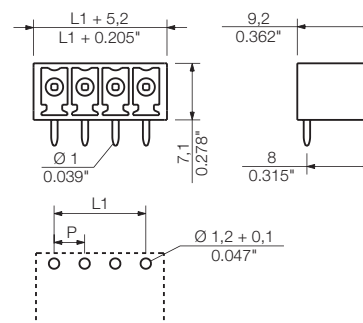

Accessories

Note: Refer to the Accessories chapter for additional accessories.

Coding		Order No.
	SC-SMT 3.81 KO GR	1968900000

Ordering data

Solder pin length		3.2 mm	3.2 mm	
Colour		Orange	Black	
Pitch 3.81 mm				
Pol.	L1 (inch)	Qty.	Order No.	Order No.
2	3.81 0.150	50	1037490000	1037870000
3	7.62 0.300	50	1037510000	1037880000
4	11.43 0.450	50	1037520000	1037890000
5	15.24 0.600	50	1037530000	1037910000
6	19.05 0.750	50	1037540000	1037920000
7	22.86 0.900	50	1037550000	1037930000
8	26.67 1.050	50	1037560000	1921620000
9	30.48 1.200	50	1037570000	1037940000
10	34.29 1.350	50	1037580000	1037950000
11	38.10 1.500	50	1037590000	1037960000
12	41.91 1.650	50	1037610000	1037970000
13	45.72 1.800	50	1037620000	1037980000
14	49.53 1.950	50	1037630000	1037990000
15	53.34 2.100	50	1037640000	1038010000
16	57.15 2.250	50	1037650000	1038020000

SC 3.81/.. /270F

with screw flange

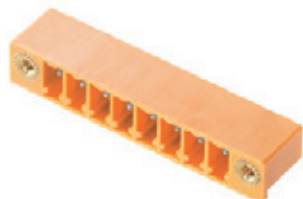

Dimensioned drawing

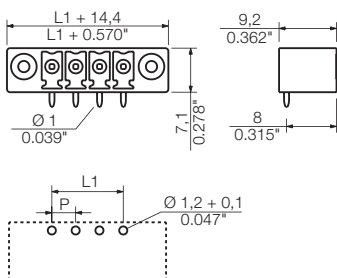

Ordering data

Solder pin length		3.2 mm	3.2 mm		
Colour		Orange	Black		
Pitch		3.81 mm			
Pol.	L1 (inch)	Qty.	Order No.	Order No.	
2	3.81	0.150	50	1038040000	1038410000
3	7.62	0.300	50	1038050000	1038420000
4	11.43	0.450	50	1038060000	1038430000
5	15.24	0.600	50	1038070000	1038440000
6	19.05	0.750	50	1038080000	1038450000
7	22.86	0.900	50	1038090000	1038460000
8	26.67	1.050	50	1038110000	1038470000
9	30.48	1.200	50	1038130000	1038480000
10	34.29	1.350	50	1038140000	1038490000
11	38.10	1.500	50	1038150000	1038510000
12	41.91	1.650	50	1038160000	1038520000
13	45.72	1.800	50	1038170000	1038530000
14	49.53	1.950	50	1038180000	1038540000
15	53.34	2.100	50	1038190000	1038550000
16	57.15	2.250	50	1038210000	1038560000

SCD 3.81/./90

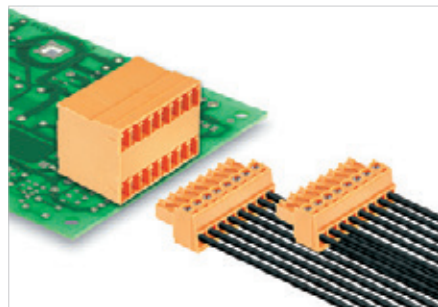

Double-level male header for wave soldering.

- Outlet direction: 90°
- Connections at the same level with access that is flush over the front of the board.
- Available in closed (G) version and with screw flange (F).

Weidmüller's 3.81 mm pitch (0.15 inch) plug-in connectors are compatible with the layouts of standard connectors and offer space for labelling and coding.

Technical data

In compliance with IEC 60664-1 / IEC 61984			
Clamping range, max.	mm ²		
Solid core H05(07) V-U	mm²		
Stranded H07 V-R			
Flexible H05(07) V-K	mm ²		
Flexible with ferrule	mm ²		
Ferrule with plastic collar	mm ²		
Stripping length	mm		
Screwdriver blade	mm		
According to norm			
Tightening torque range	Nm		
Rated current, max.	A	17.5	17
At ambient temperature		20°C	40°C
For conductor cross-section	mm ²		
Overvoltage category		III	III II
Pollution severity		3	2 2
Rated voltage	V	160	160 320
Rated impulse voltage	kV	2.5	2.5 2.5
UL / CUL (Use Group)		B	C D
Rated voltage	V	300	300
Rated current	A	10	10
AWG conductor	AWG		-
CSA (Use Group)		B	C D
Rated voltage	V	300	300
Rated current	A	10	10
AWG conductor	AWG		-
General data			
Type of insulation material		PA GF	
UL 94 flammability rating		V-0	
Contact base material		Copper alloy	
Material of contact surface		tinned	
Pin dimensions = d	mm	1.0, Octagonal	
Solder eyelet Ø = D	mm	1.2	
Solder eyelet Ø tolerance	mm	+ 0,1	

Product data

IEC: 320 V / 17.5 A
UL: 300 V / 10 A

For additional articles and information, refer to catalog.weidmueller.com

Note:

- Additional colours on request
- Gold-plated contact surfaces on request
- Rated current related to rated cross-section & min. No. of poles.
- Rated data refer only to the component itself. Clearance and creepage distances to other components are to be designed in accordance with the relevant application standards.
- P on drawing = pitch

SCD 3.81/./90G

closed side



Dimensioned drawing

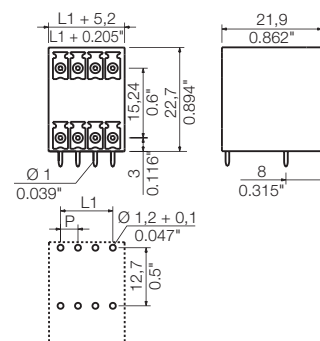

Accessories

Note: Refer to the Accessories chapter for additional accessories.

Coding		Order No.
	SC-SMT 3.81 KO GR	1968900000

Ordering data

Solder pin length		3.2 mm	3.2 mm		
Colour		Orange	Black		
Pitch 3.81 mm					
Pol.	L1	(inch)	Qty.	Order No.	Order No.
4	3.81	0.150	50	1972790000	1973100000
6	7.62	0.300	50	1972800000	1973110000
8	11.43	0.450	50	1972810000	1973120000
10	15.24	0.600	50	1972820000	1973130000
12	19.05	0.750	50	1972830000	1973140000
14	22.86	0.900	50	1972840000	1973150000
16	26.67	1.050	50	1972850000	1973160000
18	30.48	1.200	50	1972860000	1973170000
20	34.29	1.350	50	1972870000	1973180000
22	38.10	1.500	50	1972880000	1973200000
24	41.91	1.650	50	1972890000	1973210000
26	45.72	1.800	20	1972900000	1973220000
28	49.53	1.950	20	1972910000	1973230000
30	53.34	2.100	20	1972920000	1973240000
32	57.15	2.250	20	1972930000	1973250000

SCD 3.81/.. /90F

with screw flange



Dimensioned drawing

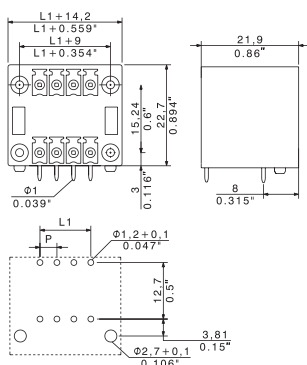

Ordering data

Solder pin length		3.2 mm	3.2 mm	
Colour		Orange	Black	
Pitch		3.81 mm		
Pol.	L1 (inch)	Qty.	Order No.	Order No.
4	3.81 0.150	50	1973260000	1973580000
6	7.62 0.300	50	1973270000	1973590000
8	11.43 0.450	50	1973280000	1973600000
10	15.24 0.600	50	1973290000	1973610000
12	19.05 0.750	50	1973300000	1973620000
14	22.86 0.900	50	1973310000	1973630000
16	26.67 1.050	50	1973320000	1973640000
18	30.48 1.200	50	1973330000	1973650000
20	34.29 1.350	50	1973340000	1973660000
22	38.10 1.500	50	1973350000	1973670000
24	41.91 1.650	50	1973360000	1973680000
26	45.72 1.800	20	1973370000	1973690000
28	49.53 1.950	20	1973380000	1973700000
30	53.34 2.100	20	1973390000	1973710000
32	57.15 2.250	20	1973400000	1973720000

SCD 3.81/././180

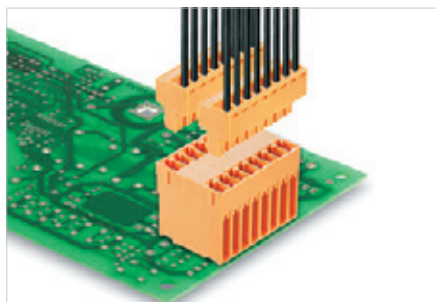

Double-level male header for wave soldering.

- Outlet direction: 180°
- Available in closed (G) version and with screw flange (F).

Weidmüller's 3.81 mm pitch (0.15 inch) plug-in connectors are compatible with the layouts of standard connectors and offer space for labelling and coding.

Technical data

In compliance with IEC 60664-1 / IEC 61984			
Clamping range, max.	mm ²		
Solid core H05(07) V-U	mm²		
Stranded H07 V-R			
Flexible H05(07) V-K	mm ²		
Flexible with ferrule	mm ²		
Ferrule with plastic collar	mm ²		
Stripping length	mm		
Screwdriver blade	mm		
According to norm			
Tightening torque range	Nm		
Rated current, max.	A	17.5	17
At ambient temperature		20°C	40°C
For conductor cross-section	mm ²		
Overvoltage category		III	III II
Pollution severity		3	2 2
Rated voltage	V	160	160 320
Rated impulse voltage	kV	2.5	2.5 2.5
UL / CUL (Use Group)		B	C D
Rated voltage	V	300	300
Rated current	A	10	10
AWG conductor	AWG		-
CSA (Use Group)		B	C D
Rated voltage	V	300	300
Rated current	A	10	10
AWG conductor	AWG		-
General data			
Type of insulation material		PA GF	
UL 94 flammability rating		V-0	
Contact base material		Copper alloy	
Material of contact surface		tinned	
Pin dimensions = d	mm	1.0, Octagonal	
Solder eyelet Ø = D	mm	1.2	
Solder eyelet Ø tolerance	mm	+ 0,1	

Product data

IEC: 320 V / 17.5 A
UL: 300 V / 10 A

For additional articles and information, refer to catalog.weidmueller.com

Note:

- Additional colours on request
- Gold-plated contact surfaces on request
- Rated current related to rated cross-section & min. No. of poles.
- Rated data refer only to the component itself. Clearance and creepage distances to the relevant application standards.
- P on drawing = pitch

SCD 3.81/././180G

closed side



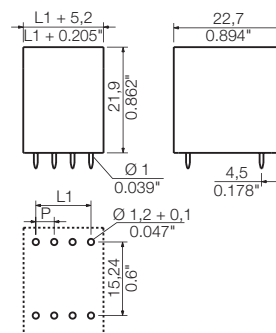

Dimensioned drawing



Accessories

Note: Refer to the Accessories chapter for additional accessories.

Coding		Order No.
	SC-SMT 3.81 KO GR	1968900000
Mounting screw		
	PTSC KA 2.2X4.5 WN1412	1610740000

Ordering data

Solder pin length		3.2 mm	3.2 mm		
Colour		Orange	Black		
Pitch 3.81 mm					
Pol.	L1	(inch)	Qty.	Order No.	Order No.
4	3.81	0.150	50	1029920000	1030260000
6	7.62	0.300	50	1029940000	1030270000
8	11.43	0.450	50	1029950000	1030280000
10	15.24	0.600	50	1029960000	1030290000
12	19.05	0.750	50	1029970000	1030310000
14	22.86	0.900	50	1029980000	1030320000
16	26.67	1.050	50	1029990000	1030340000
18	30.48	1.200	50	1030010000	1030350000
20	34.29	1.350	50	1030020000	1030360000
22	38.10	1.500	50	1030030000	1030370000
24	41.91	1.650	50	1030040000	1030380000
26	45.72	1.800	20	1030050000	1030390000
28	49.53	1.950	20	1030060000	1030410000
30	53.34	2.100	20	1030070000	1030420000
32	57.15	2.250	20	1030080000	1030430000

SCD 3.81/././180F

with screw flange



Dimensioned drawing

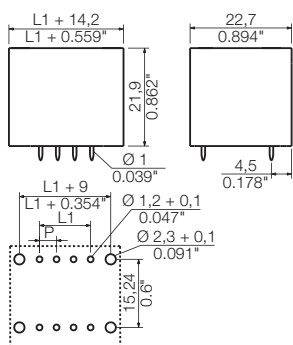

Ordering data

Solder pin length		3.2 mm	3.2 mm
Colour		Orange	Black
Pitch		3.81 mm	
Pol.	L1 (inch)	Qty.	Order No.
4	3.81 0.150	50	1030440000 1030780000
6	7.62 0.300	50	1030450000 1030790000
8	11.43 0.450	50	1030460000 1030810000
10	15.24 0.600	50	1030470000 1030820000
12	19.05 0.750	50	1030480000 1030830000
14	22.86 0.900	50	1030490000 1030840000
16	26.67 1.050	50	1030510000 1030850000
18	30.48 1.200	50	1030520000 1030860000
20	34.29 1.350	50	1030530000 1030870000
22	38.10 1.500	50	1030540000 1030880000
24	41.91 1.650	50	1030550000 1030890000
26	45.72 1.800	20	1030560000 1030910000
28	49.53 1.950	20	1030570000 1030920000
30	53.34 2.100	20	1030580000 1030930000
32	57.15 2.250	20	1030590000 1030940000

SCDN 3.81../90

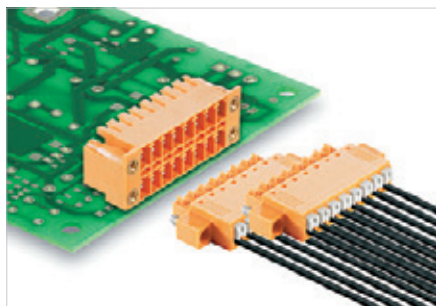

Compact double-level male header for wave soldering.

- For use with BCF 3.81 (PUSH IN) plugs.
- Orientation: 90°
- Designed for front panel applications.
- Available in closed (G) version or with screw flange (F).

Weidmüller's 3.81 mm pitch (0.15 inch) plug-in connectors are compatible with the layouts of standard connectors and offer space for labelling and coding.

Technical data

In compliance with IEC 60664-1 / IEC 61984			
Clamping range, max.	mm ²		
Solid core H05(07) V-U	mm²		
Stranded H07 V-R			
Flexible H05(07) V-K	mm ²		
Flexible with ferrule	mm ²		
Ferrule with plastic collar	mm ²		
Stripping length	mm		
Screwdriver blade	mm		
According to norm			
Tightening torque range	Nm		
Rated current, max.	A	17.5	17
At ambient temperature		20°C	40°C
For conductor cross-section	mm ²		
Overvoltage category		III	III II
Pollution severity		3	2 2
Rated voltage	V	160	160 320
Rated impulse voltage	kV	2.5	2.5 2.5
UL / CUL (Use Group)		B	C D
Rated voltage	V	300	300
Rated current	A	10	10
AWG conductor	AWG		-
CSA (Use Group)		B	C D
Rated voltage	V	300	300
Rated current	A	10	10
AWG conductor	AWG		-
General data			
Type of insulation material		PA GF	
UL 94 flammability rating		V-0	
Contact base material		Copper alloy	
Material of contact surface		tinned	
Pin dimensions = d	mm	1.0, Octagonal	
Solder eyelet Ø = D	mm	1.2	
Solder eyelet Ø tolerance	mm	+ 0,1	

Product data

IEC: 320 V / 17.5 A
UL: 300 V / 10 A

For additional articles and information, refer to catalog.weidmueller.com

- Note:**
- Additional colours on request
 - Gold-plated contact surfaces on request
 - Rated current related to rated cross-section & min. No. of poles.
 - Rated data refer only to the component itself. Clearance and creepage distances to the relevant application standards.
 - P on drawing = pitch

SCDN 3.81../90G

closed side



Dimensioned drawing

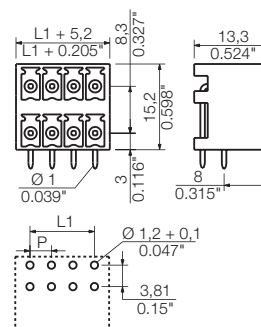

Accessories

Note: Refer to the Accessories chapter for additional accessories.

Coding		Order No.
	SC-SMT 3.81 KO GR	1968900000

Ordering data

Solder pin length		3.2 mm	3.2 mm	
Colour		Orange	Black	
Pitch 3.81 mm				
Pol.	L1 (inch)	Qty.	Order No.	Order No.
4	3.81 0.150	50	1040410000	1040790000
6	7.62 0.300	50	1040420000	1040810000
8	11.43 0.450	50	1040430000	1040820000
10	15.24 0.600	50	1040440000	1040830000
12	19.05 0.750	50	1040450000	1040840000
14	22.86 0.900	50	1040460000	1040850000
16	26.67 1.050	50	1040470000	1040860000
18	30.48 1.200	50	1040490000	1040870000
20	34.29 1.350	50	1040510000	1040890000
22	38.10 1.500	50	1040520000	1040900000
24	41.91 1.650	50	1040530000	1040910000
26	45.72 1.800	20	1040540000	1040920000
28	49.53 1.950	20	1040550000	1040930000
30	53.34 2.100	20	1040560000	1040940000
32	57.15 2.250	20	1040570000	1040950000

SCDN 3.81/.../90F

with screw flange



Dimensioned drawing

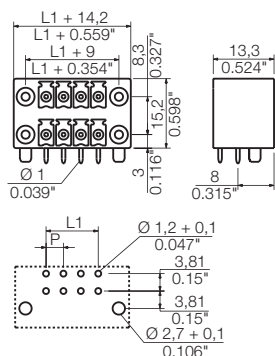

Ordering data

Solder pin length		3.2 mm	3.2 mm
Colour		Orange	Black
Pitch		3.81 mm	
Pol.	L1 (inch)	Qty.	Order No.
4	0.150	50	1040960000 1041290000
6	0.300	50	1040970000 1041310000
8	0.450	50	1040980000 1041320000
10	0.600	50	1040990000 1041330000
12	0.750	50	1041000000 1041340000
14	0.900	50	1041010000 1041350000
16	1.050	50	1041020000 1041360000
18	1.200	50	1041030000 1041370000
20	1.350	50	1041040000 1041380000
22	1.500	50	1041050000 1041390000
24	1.650	50	1041060000 1041430000
26	1.800	20	1041070000 1041450000
28	1.950	20	1041080000 1041460000
30	2.100	20	1041090000 1041470000
32	2.250	20	1041100000 1041480000

SCDV 3.81../90

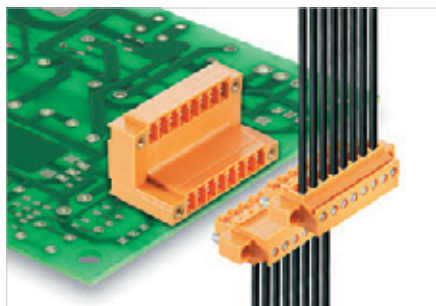

Double level male header for wave soldering.

- Orientation: 90°
- Connections at two offset levels with open access to each row.
- Available in closed (G) version or with screw flange (F).

Weidmüller's 3.81 mm pitch (0.15 inch) plug-in connectors are compatible with the layouts of standard connectors and offer space for labelling and coding.

Technical data

In compliance with IEC 60664-1 / IEC 61984			
Clamping range, max.	mm ²		
Solid core H05(07) V-U	mm²		
Stranded H07 V-R			
Flexible H05(07) V-K	mm ²		
Flexible with ferrule	mm ²		
Ferrule with plastic collar	mm ²		
Stripping length	mm		
Screwdriver blade	mm		
According to norm			
Tightening torque range	Nm		
Rated current, max.	A	17.5	17
At ambient temperature		20°C	40°C
For conductor cross-section	mm ²		
Overvoltage category		III	III II
Pollution severity		3	2 2
Rated voltage	V	160	160 320
Rated impulse voltage	kV	2.5	2.5 2.5
UL / CUL (Use Group)		B	C D
Rated voltage	V	300	300
Rated current	A	10	10
AWG conductor	AWG		-
CSA (Use Group)		B	C D
Rated voltage	V	300	300
Rated current	A	10	10
AWG conductor	AWG		-
General data			
Type of insulation material		PA GF	
UL 94 flammability rating		V-0	
Contact base material		Copper alloy	
Material of contact surface		tinned	
Pin dimensions = d	mm	1.0, Octagonal	
Solder eyelet Ø = D	mm	1.2	
Solder eyelet Ø tolerance	mm	+ 0,1	

Product data

IEC: 320 V / 17.5 A
UL: 300 V / 10 A

For additional articles and information, refer to catalog.weidmueller.com

Note:

- Additional colours on request
- Gold-plated contact surfaces on request
- Rated current related to rated cross-section & min. No. of poles.
- Rated data refer only to the component itself. Clearance and creepage distances to other components are to be designed in accordance with the relevant application standards.
- P on drawing = pitch

SCDV 3.81../90G

closed side



Dimensioned drawing

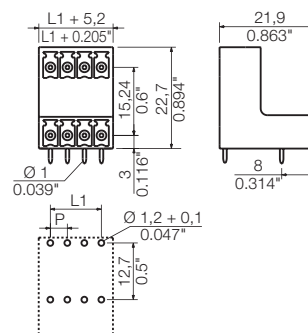

Accessories

Note: Refer to the Accessories chapter for additional accessories.

Coding		Order No.
	SC-SMT 3.81 KO GR	1968900000

Ordering data

Solder pin length	3.2 mm		3.2 mm		
	Colour	Orange	Black		
Pitch 3.81 mm					
Pol.	L1	(inch)	Qty.	Order No.	Order No.
4	3.81	0.150	50	1032090000	1032430000
6	7.62	0.300	50	1032110000	1032440000
8	11.43	0.450	50	1032120000	1032450000
10	15.24	0.600	50	1032130000	1032460000
12	19.05	0.750	50	1032140000	1032470000
14	22.86	0.900	50	1032150000	1032480000
16	26.67	1.050	50	1032160000	1032490000
18	30.48	1.200	50	1032170000	1032500000
20	34.29	1.350	50	1032190000	1032510000
22	38.10	1.500	50	1032200000	1032520000
24	41.91	1.650	50	1032210000	1032530000
26	45.72	1.800	20	1032220000	1032540000
28	49.53	1.950	20	1032230000	1032550000
30	53.34	2.100	20	1032240000	1032560000
32	57.15	2.250	20	1032250000	1032570000

SCDV 3.81../90F

with screw flange



Dimensioned drawing

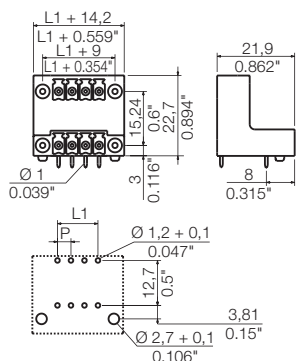

Ordering data

Solder pin length		3.2 mm	3.2 mm	
Colour		Orange	Black	
Pitch		3.81 mm		
Pol.	L1 (inch)	Qty.	Order No.	Order No.
4	3.81 0.150	50	1032580000	1032920000
6	7.62 0.300	50	1032590000	1032930000
8	11.43 0.450	50	1032600000	1032940000
10	15.24 0.600	50	1032610000	1032950000
12	19.05 0.750	50	1032620000	1032960000
14	22.86 0.900	50	1032630000	1032970000
16	26.67 1.050	50	1032640000	1032990000
18	30.48 1.200	50	1032650000	1033010000
20	34.29 1.350	50	1032660000	1033020000
22	38.10 1.500	50	1032670000	1033030000
24	41.91 1.650	50	1032680000	1033040000
26	45.72 1.800	20	1032690000	1033050000
28	49.53 1.950	20	1032710000	1033060000
30	53.34 2.100	20	1032720000	1033070000
32	57.15 2.250	20	1032730000	1033090000

SCDV 3.81../180

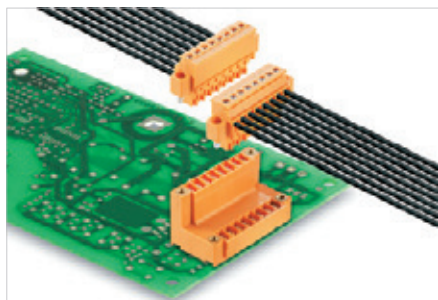

Double-level male header for wave soldering.

- Orientation: 180°.
- Connections at two offset levels with open access to each row.
- Available in closed (G) version or with screw flange (F).

Weidmüller's 3.81 mm pitch (0.15 inch) plug-in connectors are compatible with the layouts of standard connectors and offer space for labelling and coding.

Technical data

In compliance with IEC 60664-1 / IEC 61984			
Clamping range, max.	mm ²		
Solid core H05(07) V-U	mm²		
Stranded H07 V-R			
Flexible H05(07) V-K	mm ²		
Flexible with ferrule	mm ²		
Ferrule with plastic collar	mm ²		
Stripping length	mm		
Screwdriver blade	mm		
According to norm			
Tightening torque range	Nm		
Rated current, max.	A	17.5	17
At ambient temperature		20°C	40°C
For conductor cross-section	mm ²		
Overvoltage category		III	III II
Pollution severity		3	2 2
Rated voltage	V	160	160 320
Rated impulse voltage	kV	2.5	2.5 2.5
UL / CUL (Use Group)	B C D		
Rated voltage	V	300	300
Rated current	A	10	10
AWG conductor	AWG		-
CSA (Use Group)	B C D		
Rated voltage	V	300	300
Rated current	A	10	10
AWG conductor	AWG		-
General data			
Type of insulation material		PA GF	
UL 94 flammability rating		V-0	
Contact base material		Copper alloy	
Material of contact surface		tinned	
Pin dimensions = d	mm	1.0, Octagonal	
Solder eyelet Ø = D	mm	1.2	
Solder eyelet Ø tolerance	mm	+ 0,1	

Product data

IEC: 320 V / 17.5 A
UL: 300 V / 10 A

For additional articles and information, refer to catalog.weidmuller.com

Note:

- Additional colours on request
- Gold-plated contact surfaces on request
- Rated current related to rated cross-section & min. No. of poles.
- Rated data refer only to the component itself. Clearance and creepage distances to the relevant application standards.
- P on drawing = pitch

SCDV 3.81../180G

closed side



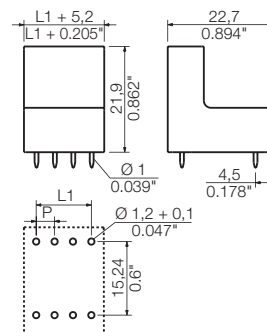

Dimensioned drawing



Accessories

Note: Refer to the Accessories chapter for additional accessories.

Coding		Order No.
	SC-SMT 3.81 KO GR	1968900000
	PTSC KA 2.2X4.5 WN1412	1610740000

Ordering data

Solder pin length	3.2 mm		3.2 mm		
	Orange	Black			
Pitch	3.81 mm				
Pol.	L1	(inch)	Qty.	Order No.	Order No.
4	3.81	0.150	50	1034470000	1034820000
6	7.62	0.300	50	1034490000	1034830000
8	11.43	0.450	50	1034510000	1034840000
10	15.24	0.600	50	1034520000	1034850000
12	19.05	0.750	50	1034530000	1034860000
14	22.86	0.900	50	1034540000	1034870000
16	26.67	1.050	50	1034550000	1034880000
18	30.48	1.200	50	1034560000	1034890000
20	34.29	1.350	50	1034570000	1034910000
22	38.10	1.500	50	1034580000	1034920000
24	41.91	1.650	50	1034590000	1034930000
26	45.72	1.800	20	1034610000	1034940000
28	49.53	1.950	20	1034620000	1034950000
30	53.34	2.100	20	1034630000	1034960000
32	57.15	2.250	20	1034640000	1034970000

SCDV 3.81/././180F

with screw flange



Dimensioned drawing

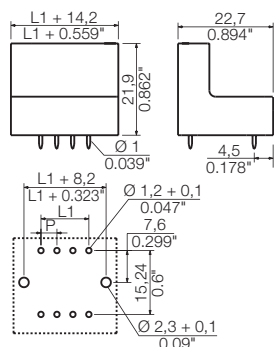

Ordering data

Solder pin length		3.2 mm	3.2 mm
Colour		Orange	Black
Pitch		3.81 mm	
Pol.	L1 (inch)	Qty.	Order No.
4	3.81 0.150	50	1034980000 1035310000
6	7.62 0.300	50	1034990000 1035320000
8	11.43 0.450	50	1035010000 1035330000
10	15.24 0.600	50	1035020000 1035340000
12	19.05 0.750	50	1035030000 1035350000
14	22.86 0.900	50	1035040000 1035360000
16	26.67 1.050	50	1035050000 1035370000
18	30.48 1.200	50	1035060000 1035380000
20	34.29 1.350	50	1035070000 1035390000
22	38.10 1.500	50	1035080000 1035410000
24	41.91 1.650	50	1035090000 1035420000
26	45.72 1.800	20	1035110000 1035430000
28	49.53 1.950	20	1035120000 1035440000
30	53.34 2.100	20	1035130000 1035450000
32	57.15 2.250	20	1035140000 1035460000

SCZ 3.81/./180

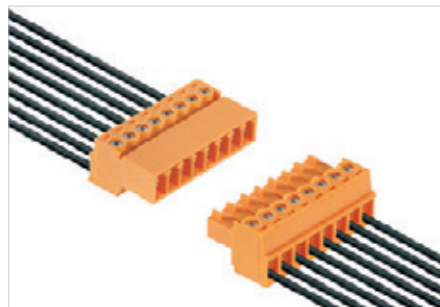

Inverted male plug with screw connection:

- Wire-to-wire connection with the BCZ female plug
- Board-to-wire connection with the BCL-SMT female header.
- Available in closed (G) version, screw flange (F), inverted flange (FI) and with lock and release lever (LR).

Weidmüller's 3.81 mm pitch (0.15 inch) plug-in connectors are compatible with the layouts of standard connectors and offer space for labelling and coding.

Product data

IEC: 320 V / 17.5 A / 0.2 - 1.5 mm²
UL: 300 V / 10 A / AWG 28 - 16

For additional articles and information, refer to catalog.weidmueller.com

Note:

- Additional colours on request
- Gold-plated contact surfaces on request
- Rated current related to rated cross-section & min. No. of poles.
- Wire end ferrule with plastic collar to DIN 46228/4
- P on drawing = pitch
- Rated data refer only to the component itself. Clearance and creepage distances to other components are to be designed in accordance with the relevant application standards.

SCZ 3.81/./180G

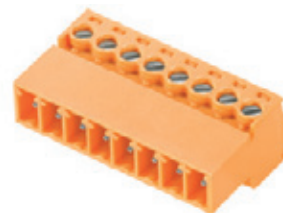

Dimensioned drawing

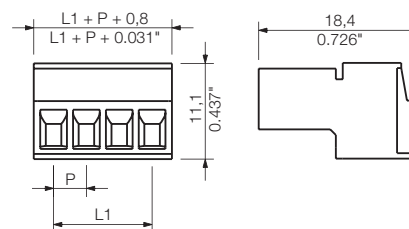

Technical data

In compliance with IEC 60664-1 / IEC 61984

Clamping range, max.	mm ²	0.08...1.5
Solid core H05(07) V-U	mm²	0.2...1.5
Stranded H07 V-R		
Flexible H05(07) V-K	mm ²	0.2...1.5
Flexible with ferrule	mm ²	0.2...1.5
Ferrule with plastic collar	mm ²	0.2...1.5
Stripping length	mm	7
Screwdriver blade	mm	0.4 x 2.5
According to norm		DIN 5264
Tightening torque range	Nm	0.2...0.25
Rated current, max.	A	17.5 17.5
At ambient temperature		20°C 40°C
For conductor cross-section	mm ²	1
Overvoltage category		III III II
Pollution severity		3 2 2
Rated voltage	V	160 160 320
Rated impulse voltage	kV	2.5 2.5 2.5
UL / CUL (Use Group)	B C D	D
Rated voltage	V	300 300
Rated current	A	10 10
AWG conductor	AWG	28-16
CSA (Use Group)	B C D	D
Rated voltage	V	300 300
Rated current	A	10 10
AWG conductor	AWG	28-16
General data		
Type of insulation material		PA GF
UL 94 flammability rating		V-0
Contact base material		Copper alloy
Material of contact surface		tinned
Pin dimensions = d	mm	
Solder eyelet Ø = D	mm	
Solder eyelet Ø tolerance	mm	

Accessories

Note: Refer to the Accessories chapter for additional accessories.

Coding	Order No.
SC-SMT 3.81 KO GR	1968900000
Screwdriver	
SDIS 0.4X2.5X75	9008370000
SDS 0.4X2.5X75	9009030000

Ordering data

Solder pin length						
Colour	Orange		Black			
Pitch	3.81 mm					
Pol.	L1	(inch)	Qty.	Order No.	Order No.	
2	3.81	0.150	50	1969520000	1970010000	
3	7.62	0.300	50	1969540000	1970020000	
4	11.43	0.450	50	1969560000	1970030000	
5	15.24	0.600	50	1969570000	1970050000	
6	19.05	0.750	50	1969580000	1970060000	
7	22.86	0.900	50	1969590000	1970070000	
8	26.67	1.050	50	1969610000	1970080000	
9	30.48	1.200	50	1969630000	1970090000	
10	34.29	1.350	50	1969640000	1970100000	
11	38.10	1.500	50	1969660000	1970110000	
12	41.91	1.650	50	1969670000	1970120000	

Representative deratings curve

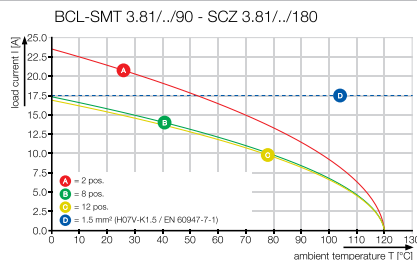

SCZ 3.81../180F

with screw flange

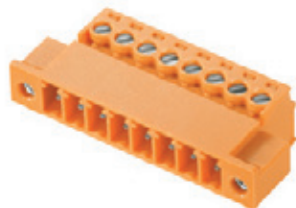

Dimensioned drawing

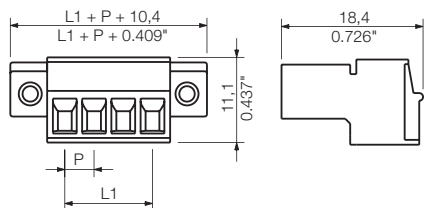

Ordering data

Solder pin length						
Colour		Orange	Black			
Pitch	3.81 mm					
Pol.	L1	(inch)	Qty.	Order No.	Order No.	
2	3.81	0.150	50	1970910000	1971290000	
3	7.62	0.300	50	1970920000	1971310000	
4	11.43	0.450	50	1970930000	1971320000	
5	15.24	0.600	50	1970940000	1971340000	
6	19.05	0.750	50	1970960000	1971350000	
7	22.86	0.900	50	1970970000	1971360000	
8	26.67	1.050	50	1970980000	1971370000	
9	30.48	1.200	50	1970990000	1971400000	
10	34.29	1.350	50	1971000000	1971410000	
11	38.10	1.500	50	1971010000	1971510000	
12	41.91	1.650	50	1971020000	1971520000	

SCZ 3.81../180FI

with inverted flange



Dimensioned drawing

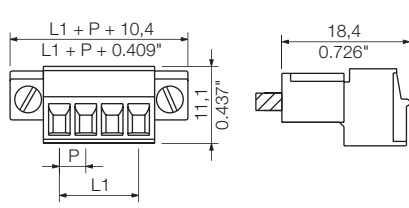

Ordering data

Solder pin length						
Colour		Orange	Black			
Pitch	3.81 mm					
Pol.	L1	(inch)	Qty.	Order No.	Order No.	
2	3.81	0.150	50	1970260000	1970700000	
3	7.62	0.300	50	1970270000	1970710000	
4	11.43	0.450	50	1970310000	1970720000	
5	15.24	0.600	50	1970320000	1970740000	
6	19.05	0.750	50	1970340000	1970760000	
7	22.86	0.900	50	1970350000	1970770000	
8	26.67	1.050	50	1970360000	1970780000	
9	30.48	1.200	50	1970390000	1970790000	
10	34.29	1.350	50	1970410000	1970800000	
11	38.10	1.500	50	1970420000	1970810000	
12	41.91	1.650	50	1970430000	1970830000	

SCZ 3.81../180LR

with release latch



Dimensioned drawing

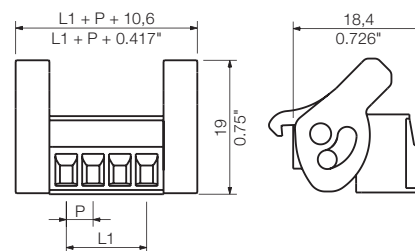

Ordering data

Solder pin length						
Colour		Orange	Black			
Pitch	3.81 mm					
Pol.	L1	(inch)	Qty.	Order No.	Order No.	
2	3.81	0.150	50	1971580000	1971980000	
3	7.62	0.300	50	1971600000	1971990000	
4	11.43	0.450	50	1971610000	1972010000	
5	15.24	0.600	50	1971630000	1972020000	
6	19.05	0.750	50	1971640000	1972040000	
7	22.86	0.900	50	1971660000	1972050000	
8	26.67	1.050	50	1971670000	1972060000	
9	30.48	1.200	50	1971680000	1972080000	
10	34.29	1.350	50	1971690000	1972090000	
11	38.10	1.500	50	1971700000	1972110000	
12	41.91	1.650	50	1971710000	1972120000	

Additional deratings curves

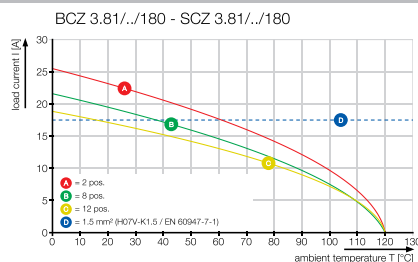
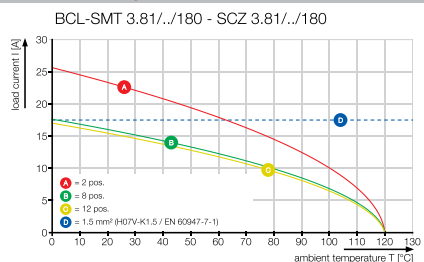

SCZ 3.81../180 ZE



Inverted male plug with screw connection and strain relief for the connected cable.

- Wire-to-wire connection with female plugs.
- Board-to-wire connection with BCL-SMT female header.
- Available in closed (G) version, screw flange (F), inverted flange (FI) and with lock and release lever (LR).

Weidmüller's 3.81 mm pitch (0.15 inch) plug-in connectors are compatible with the layouts of standard connectors and offer space for labelling and coding.

Product data

IEC: 320 V / 17.5 A / 0.2 - 1.5 mm²
UL: 300 V / 10 A / AWG 28 - 16

For additional articles and information, refer to catalog.weidmueller.com

Note:

- Additional colours on request
- Gold-plated contact surfaces on request
- Rated current related to rated cross-section & min. No. of poles.
- Wire end ferrule with plastic collar to DIN 46228/4
- P on drawing = pitch
- Rated data refer only to the component itself. Clearance and creepage distances to other components are to be designed in accordance with the relevant application standards.

SCZ 3.81../180GZE

with strain relief



Dimensioned drawing

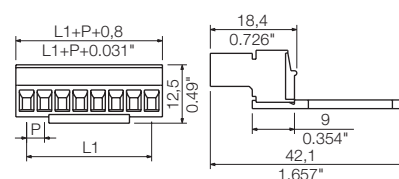

Technical data

In compliance with IEC 60664-1 / IEC 61984

Clamping range, max.	mm ²	0.08...1.5
Solid core H05(07) V-U	mm²	0.2...1.5
Stranded H07 V-R		
Flexible H05(07) V-K	mm ²	0.2...1.5
Flexible with ferrule	mm ²	0.2...1.5
Ferrule with plastic collar	mm ²	0.2...1.5
Stripping length	mm	7
Screwdriver blade	mm	0.4 x 2.5
According to norm		DIN 5264
Tightening torque range	Nm	0.2...0.25
Rated current, max.	A	17.5 17.5
At ambient temperature	20°C	40°C
For conductor cross-section	mm ²	1
Overvoltage category		III III II
Pollution severity		3 2 2
Rated voltage	V	160 160 320
Rated impulse voltage	kV	2.5 2.5 2.5
UL / CUL (Use Group)	B C D	
Rated voltage	V	300 300
Rated current	A	10 10
AWG conductor	AWG	28-16
CSA (Use Group)	B C D	
Rated voltage	V	300 300
Rated current	A	10 10
AWG conductor	AWG	28-16
General data		
Type of insulation material		PA GF
UL 94 flammability rating		V-0
Contact base material		Copper alloy
Material of contact surface		tinned
Pin dimensions = d	mm	
Solder eyelet Ø = D	mm	
Solder eyelet Ø tolerance	mm	

Accessories

Note: Refer to the Accessories chapter for additional accessories.

Coding		Order No.
	SC-SMT 3.81 KO GR	1968900000
Screwdriver		
	SDIS 0.4X2.5X75	9008370000
	SDS 0.4X2.5X75	9009030000

Ordering data

Solder pin length						
Colour	Orange		Black			
Pitch	3.81 mm					
Pol.	L1	(inch)	Qty.	Order No.	Order No.	
4	11.43	0.450	50	1237000000	1236990000	
5	15.24	0.600	50	1237010000	1071710000	
6	19.05	0.750	50	1237020000	1071720000	
7	22.86	0.900	50	1237030000	1071730000	
8	26.67	1.050	50	1237040000	1071740000	
9	30.48	1.200	50	1237070000	1071750000	
10	34.29	1.350	50	1237080000	1071760000	
11	38.10	1.500	50	1237090000	1071770000	
12	41.91	1.650	50	1237100000	1071780000	

from 10 pole 2 strain reliefs per plug-in connector

Representative deratings curve

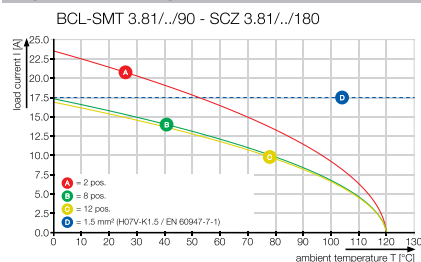

from 10 pole 2 strain reliefs per plug-in connector

SCZ 3.81../180FZE

with screw flange and strain relief



Dimensioned drawing

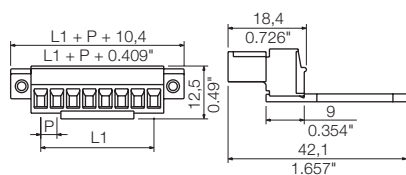

Ordering data

Solder pin length						
Colour		Orange	Black			
Pitch 3.81 mm						
Pol.	L1	(inch)	Qty.	Order No.	Order No.	
4	11.43	0.450	50	1237120000	1237110000	
5	15.24	0.600	50	1237130000	1071790000	
6	19.05	0.750	50	1237140000	1071810000	
7	22.86	0.900	50	1237170000	1071820000	
8	26.67	1.050	50	1237180000	1071830000	
9	30.48	1.200	50	1237190000	1071840000	
10	34.29	1.350	50	1237200000	1071850000	
11	38.10	1.500	50	1237210000	1071860000	
12	41.91	1.650	50	1237220000	1071870000	

SCZ 3.81../180FZE

with inverted screw flange and strain relief



Dimensioned drawing

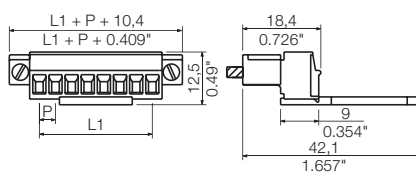

Ordering data

Solder pin length						
Colour		Orange	Black			
Pitch 3.81 mm						
Pol.	L1	(inch)	Qty.	Order No.	Order No.	
4	11.43	0.450	50	1237550000	1237440000	
5	15.24	0.600	50	1237560000	1237450000	
6	19.05	0.750	50	1237570000	1237470000	
7	22.86	0.900	50	1237580000	1237480000	
8	26.67	1.050	50	1237590000	1237490000	
9	30.48	1.200	50	1237610000	1237510000	
10	34.29	1.350	50	1237620000	1237520000	
11	38.10	1.500	50	1237630000	1237530000	
12	41.91	1.650	50	1237640000	1237540000	

SCZ 3.81../180LRZE

with release latch and strain relief



Dimensioned drawing

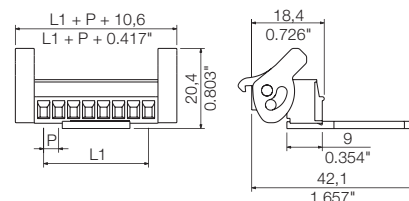

Ordering data

Solder pin length						
Colour		Orange	Black			
Pitch 3.81 mm						
Pol.	L1	(inch)	Qty.	Order No.	Order No.	
4	11.43	0.450	50	1237340000	1237230000	
5	15.24	0.600	50	1237350000	1237240000	
6	19.05	0.750	50	1237370000	1237270000	
7	22.86	0.900	50	1237380000	1237280000	
8	26.67	1.050	50	1237390000	1237290000	
9	30.48	1.200	50	1237400000	1237300000	
10	34.29	1.350	50	1237410000	1237310000	
11	38.10	1.500	50	1237420000	1237320000	
12	41.91	1.650	50	1237430000	1237330000	

from 10 pole 2 strain reliefs per plug-in connector

from 10 pole 2 strain reliefs per plug-in connector

from 10 pole 2 strain reliefs per plug-in connector

Additional deratings curves

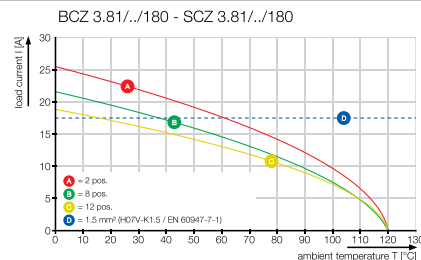
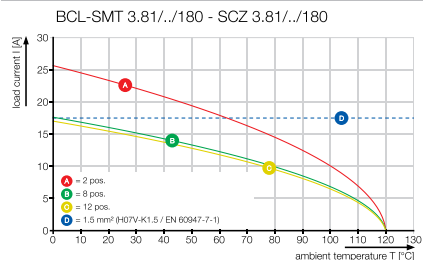

BCZ 3.81../180

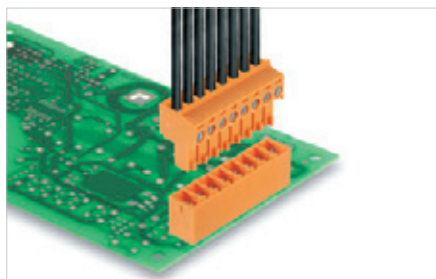

Female plug with screw connection. Wire outlet 180° (wire is straight on to the direction of plugging).

- Available in closed version, with screw flange (F) and lock and release-lever (LR).

Weidmüller's 3.81 mm pitch (0.15 inch) plug-in connectors are compatible with the layouts of standard connectors and offer space for labelling and coding.

Technical data

In compliance with IEC 60664-1 / IEC 61984			
Clamping range, max.	mm ²	0.08...1.5	
Solid core H05(07) V-U	mm ²	0.2...1.5	
Stranded H07 V-R			
Flexible H05(07) V-K	mm ²	0.2...1.5	
Flexible with ferrule	mm ²	0.2...1.5	
Ferrule with plastic collar	mm ²	0.2...1.5	
Stripping length	mm	7	
Screwdriver blade	mm	0.4 x 2.5	
According to norm		DIN 5264	
Tightening torque range	Nm	0.2...0.25	
Rated current, max.	A	17.5	17
At ambient temperature		20°C	40°C
For conductor cross-section	mm ²	1	
Overvoltage category		III	III II
Pollution severity		3	2 2
Rated voltage	V	160	160 320
Rated impulse voltage	kV	2.5	2.5 2.5
UL / CUL (Use Group)		B	C D
Rated voltage	V	300	300
Rated current	A	10	10
AWG conductor	AWG	28-16	
CSA (Use Group)		B	C D
Rated voltage	V	300	300
Rated current	A	10	10
AWG conductor	AWG	28-16	
General data			
Type of insulation material		PA GF	
UL 94 flammability rating		V-0	
Contact base material		Copper alloy	
Material of contact surface		tinned	
Pin dimensions = d	mm		
Solder eyelet Ø = D	mm		
Solder eyelet Ø tolerance	mm		

Product data

IEC: 320 V / 17.5 A / 0.2 - 1.5 mm²
UL: 300 V / 10 A / AWG 28 - 16

For additional articles and information, refer to catalog.weidmueller.com

Note:

- Additional colours on request
- Gold-plated contact surfaces on request
- Rated current related to rated cross-section & min. No. of poles.
- Wire end ferrule without plastic collar to DIN 46228/1
- Wire end ferrule with plastic collar to DIN 46228/4
- P on drawing = pitch
- Rated data refer only to the component itself. Clearance and creepage distances to other components are to be designed in accordance with the relevant application standards.

BCZ 3.81../180



Dimensioned drawing

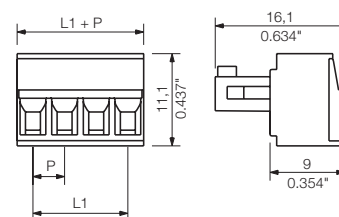

Accessories

Note: Refer to the Accessories chapter for additional accessories.

Hood	Order No.
BCZ 3.81 AH03	1005280000
BCZ 3.81 AH04	1005290000
BCZ 3.81 AH05	1005300000
BCZ 3.81 AH06	1005310000
BCZ 3.81 AH07	1005320000
BCZ 3.81 AH08	1005330000
BCZ 3.81 AH09	1005340000
BCZ 3.81 AH10	1005350000
BCZ 3.81 AH12	1005370000
BCZ 3.81 AH13	1005380000
BCZ 3.81 AH14	1005390000
BCZ 3.81 AH15	1005400000
BCZ 3.81 AH16	1005410000
Screwdriver	
SDIS 0.4X2.5X7.5	9008370000
SDS 0.4X2.5X7.5	9009030000

Ordering data

Solder pin length						
Colour	Orange		Black			
Pitch	3.81 mm					
Pol.	L1	(inch)	Qty.	Order No.	Order No.	
2	3.81	0.150	50	1940730000	1792770000	
3	7.62	0.300	50	1940740000	1792780000	
4	11.43	0.450	50	1940750000	1792790000	
5	15.24	0.600	50	1940760000	1792800000	
6	19.05	0.750	50	1940770000	1792810000	
7	22.86	0.900	50	1940780000	1871410000	
8	26.67	1.050	50	1940790000	1792820000	
9	30.48	1.200	50	1940800000	1871390000	
10	34.29	1.350	50	1940810000	1792830000	
11	38.10	1.500	50	1940820000	1899400000	
12	41.91	1.650	50	1940830000	1792840000	
13	45.72	1.800	50	1940840000	1899440000	
14	49.53	1.950	50	1940850000	1899480000	
15	53.34	2.100	50	1940860000	1899520000	
16	57.15	2.250	50	1940870000	1792850000	
17	60.96	2.550	50	1940890000	1940970000	
18	64.77	2.550	50	1940900000	1940980000	
19	68.58	2.700	50	1940910000	1940990000	
20	72.39	2.850	50	1940920000	1941000000	

Representative deratings curve

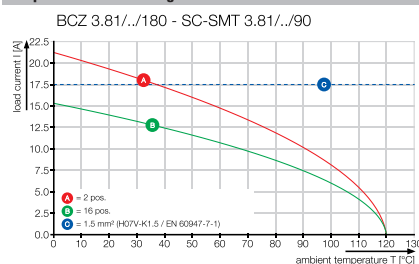

BCZ 3.81/././180F

with screw flange



Dimensioned drawing

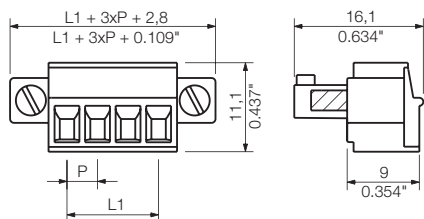

Ordering data

Solder pin length					
Colour	Orange	Black			
Pitch	3.81 mm				
Pol.	L1	(inch)	Qty.	Order No.	Order No.
2	3.81	0.150	50	1941010000	1792950000
3	7.62	0.300	50	1941020000	1792960000
4	11.43	0.450	50	1941030000	1792970000
5	15.24	0.600	50	1941040000	1792980000
6	19.05	0.750	50	1941050000	1792990000
7	22.86	0.900	50	1941060000	1837020000
8	26.67	1.050	50	1941070000	1793000000
9	30.48	1.200	50	1941080000	1899530000
10	34.29	1.350	50	1941090000	1793010000
11	38.10	1.500	50	1941100000	1899550000
12	41.91	1.650	50	1941110000	1793020000
13	45.72	1.800	50	1941120000	1899570000
14	49.53	1.950	50	1941130000	1899590000
15	53.34	2.100	50	1941140000	1899610000
16	57.15	2.250	50	1941150000	1793030000
17	60.96	2.400	50	1941160000	1941360000
18	64.77	2.550	50	1941170000	1941370000
19	68.58	2.700	50	1941180000	1941380000
20	72.39	2.850	50	1941190000	1941390000

BCZ 3.81/././180LR

with release latch



Dimensioned drawing

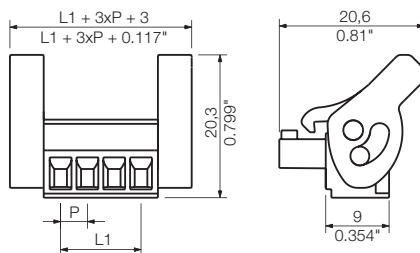

Ordering data

Solder pin length					
Colour	Orange	Black			
Pitch	3.81 mm				
Pol.	L1	(inch)	Qty.	Order No.	Order No.
2	3.81	0.150	50	1941400000	1941780000
3	7.62	0.300	50	1941410000	1941790000
4	11.43	0.450	50	1941420000	1941800000
5	15.24	0.600	50	1941430000	1941810000
6	19.05	0.750	50	1941440000	1941820000
7	22.86	0.900	50	1941450000	1941830000
8	26.67	1.050	50	1941460000	1941840000
9	30.48	1.200	50	1941470000	1941850000
10	34.29	1.350	50	1941480000	1941860000
11	38.10	1.500	50	1941490000	1941870000
12	41.91	1.650	50	1941500000	1941880000
13	45.72	1.800	50	1941510000	1941890000
14	49.53	1.950	50	1941520000	1941900000
15	53.34	2.100	50	1941530000	1941910000
16	57.15	2.250	50	1941540000	1941920000
17	60.96	2.400	50	1941550000	1941930000
18	64.77	2.550	50	1941560000	1941940000
19	68.58	2.700	50	1941570000	1941950000
20	72.39	2.850	50	1941580000	1941960000

Additional deratings curves

BCZ 3.81/././180 - SCDV-THR 3.81/././90

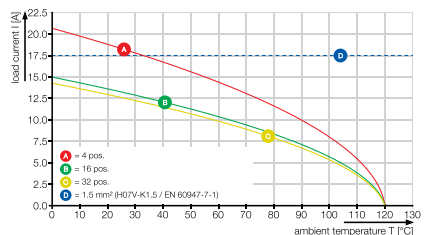

BCZ 3.81/././180 - SCDV-THR 3.81/././180

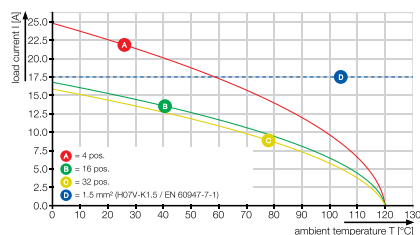

BCZ 3.81../180 ZE



Female plug with screw connection and strain relief for the connected cable. Wire outlet 180° (wire is straight on to the direction of plugging).

- Available in closed version, with screw flange (F) and lock and release-lever (LR).

Weidmüller's 3.81 mm pitch (0.15 inch) plug-in connectors are compatible with the layouts of standard connectors and offer space for labelling and coding.

Technical data

In compliance with IEC 60664-1 / IEC 61984			
Clamping range, max.	mm ²	0.08...1.5	
Solid core H05(07) V-U	mm ²	0.2...1.5	
Stranded H07 V-R			
Flexible H05(07) V-K	mm ²	0.2...1.5	
Flexible with ferrule	mm ²	0.2...1.5	
Ferrule with plastic collar	mm ²	0.2...1.5	
Stripping length	mm	7	
Screwdriver blade	mm		
According to norm		DIN 5264	
Tightening torque range	Nm	0.2...0.25	
Rated current, max.	A	17.5	17
At ambient temperature		20°C	40°C
For conductor cross-section	mm ²	1	
Overvoltage category		III	III II
Pollution severity		3	2 2
Rated voltage	V	160	160 320
Rated impulse voltage	kV	2.5	2.5 2.5
UL / CUL (Use Group)		B	C D
Rated voltage	V	300	300
Rated current	A	10	10
AWG conductor	AWG	28-16	
CSA (Use Group)		B	C D
Rated voltage	V	300	300
Rated current	A	10	10
AWG conductor	AWG	28-16	
General data			
Type of insulation material		PA GF	
UL 94 flammability rating		V-0	
Contact base material		Copper alloy	
Material of contact surface			
Pin dimensions = d	mm		
Solder eyelet Ø = D	mm		
Solder eyelet Ø tolerance	mm		

Product data

IEC: 320 V / 17.5 A / 0.2 - 1.5 mm²
UL: 300 V / 10 A / AWG 28 - 16

For additional articles and information, refer to catalog.weidmueller.com

Note:

- Additional colours on request
- Gold-plated contact surfaces on request
- Rated current related to rated cross-section & min. No. of poles.
- Wire end ferrule without plastic collar to DIN 46228/1
- Wire end ferrule with plastic collar to DIN 46228/4
- P on drawing = pitch
- Rated data refer only to the component itself. Clearance and creepage distances to other components are to be designed in accordance with the relevant application standards.

BCZ 3.81../180ZE

with strain relief



Dimensioned drawing

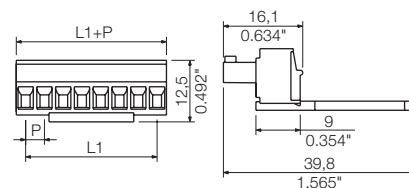

Accessories

Note: Refer to the Accessories chapter for additional accessories.

Screwdriver		Order No.
	SDIS 0.4X2.5X75	9008370000
	SDS 0.4X2.5X75	9009030000

Ordering data

Solder pin length						
Colour	Orange		Black			
Pitch	3.81 mm					
Pol.	L1	(inch)	Qty.	Order No.	Order No.	
5	15.24	0.600	50	1236270000	1071950000	
6	19.05	0.750	50	1236280000	1071960000	
7	22.86	0.900	50	1236290000	1071970000	
8	26.67	1.050	50	1236300000	1941970000	
9	30.48	1.200	50	1236320000	1071980000	
10	34.29	1.350	50	1236330000	1072010000	
11	38.10	1.500	50	1236340000	1072020000	
12	41.91	1.650	50	1236370000	1072030000	
13	45.72	1.800	50	1236380000	1072040000	
14	49.53	1.950	50	1236390000	1072050000	
15	53.34	2.100	50	1236400000	1072060000	
16	57.15	2.250	50	1236410000	1072070000	
17	60.96	2.400	50	1236420000	1072080000	
18	64.77	2.550	50	1236430000	1072090000	
19	68.58	2.700	50	1236440000	1072110000	
20	72.39	2.850	50	1236470000	1072120000	

from 10 pole 2 strain reliefs per plug-in connector

Representative deratings curve

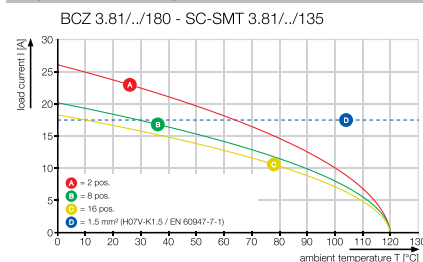

from 10 pole 2 strain reliefs per plug-in connector

BCZ 3.81/./180FZE

with screw flange and strain relief



Dimensioned drawing

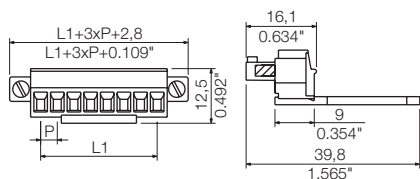

BCZ 3.81/./180LRZE

with release latch and strain relief



Dimensioned drawing

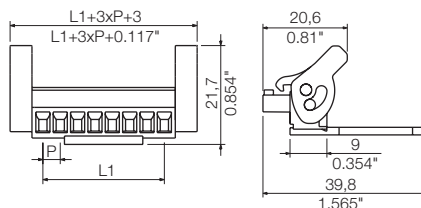

Ordering data

Solder pin length					
Colour	Orange		Black		
Pitch	3.81 mm				
Pol.	L1	(inch)	Qty.	Order No.	Order No.
5	15.24	0.600	50	1236530000	1072130000
6	19.05	0.750	50	1236540000	1072140000
7	22.86	0.900	50	1236570000	1072150000
8	26.67	1.050	50	1236590000	1941980000
9	30.48	1.200	50	1236600000	1072160000
10	34.29	1.350	50	1236610000	1072170000
11	38.10	1.500	50	1236620000	1072180000
12	41.91	1.650	50	1236630000	1072190000
13	45.72	1.800	50	1236640000	1072200000
14	49.53	1.950	50	1236670000	1072230000
15	53.34	2.100	50	1236680000	1072240000
16	57.15	2.250	50	1236690000	1072250000
17	60.96	2.400	50	1236700000	1072260000
18	64.77	2.550	50	1236720000	1072270000
19	68.58	2.700	50	1236730000	1072280000
20	72.39	2.850	50	1236740000	1072290000

Ordering data

Solder pin length					
Colour	Orange		Black		
Pitch	3.81 mm				
Pol.	L1	(inch)	Qty.	Order No.	Order No.
5	15.24	0.600	50	1236790000	1072310000
6	19.05	0.750	50	1236800000	1072320000
7	22.86	0.900	50	1236810000	1072330000
8	26.67	1.050	50	1236820000	1941990000
9	30.48	1.200	50	1236830000	1072340000
10	34.29	1.350	50	1236840000	1072350000
11	38.10	1.500	50	1236850000	1072360000
12	41.91	1.650	50	1236870000	1072370000
13	45.72	1.800	50	1236880000	1072380000
14	49.53	1.950	50	1236890000	1072390000
15	53.34	2.100	50	1236900000	1072450000
16	57.15	2.250	50	1236910000	1072460000
17	60.96	2.400	50	1236920000	1072470000
18	64.77	2.550	50	1236930000	1072480000
19	68.58	2.700	50	1236940000	1072490000
20	72.39	2.850	50	1236970000	1072510000

from 10 pole 2 strain reliefs per plug-in connector

from 10 pole 2 strain reliefs per plug-in connector

Additional deratings curves

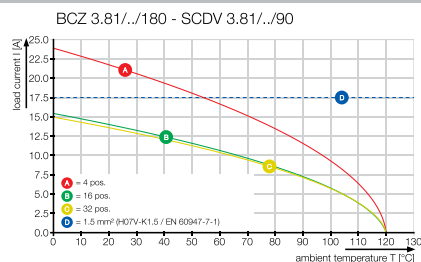
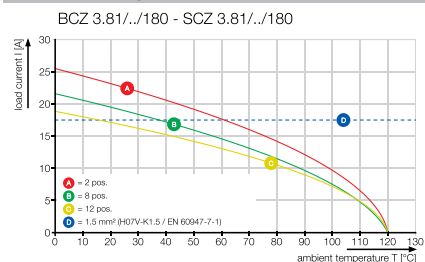

BCZ 3.81/./90 & 270

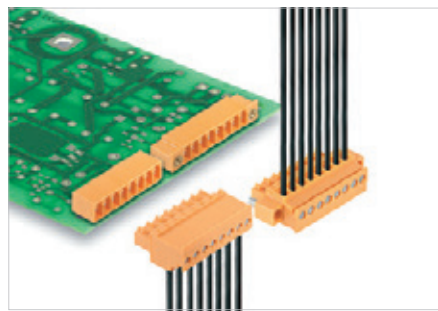

Female plug with screw connection.

Wire outlet direction:

- 90° - wire perpendicular to plugging direction and above
- 270° - wire perpendicular to plugging direction and below
- Available in closed version and with screw flange (F).

Weidmüller's 3.81 mm pitch (0.15 inch) plug-in connectors are compatible with the layouts of standard connectors and offer space for labelling and coding.

Product data

IEC: 320 V / 17.5 A / 0.2 - 1.5 mm²
UL: 300 V / 10 A / AWG 28 - 16

For additional articles and information, refer to catalog.weidmueller.com

Note:

- Additional colours on request
- Gold-plated contact surfaces on request
- Rated current related to rated cross-section & min. No. of poles.
- Wire end ferrule without plastic collar to DIN 46228/1
- Wire end ferrule with plastic collar to DIN 46228/4
- P on drawing = pitch
- Rated data refer only to the component itself. Clearance and creepage distances to other components are to be designed in accordance with the relevant application standards.

BCZ 3.81/./90



Dimensioned drawing

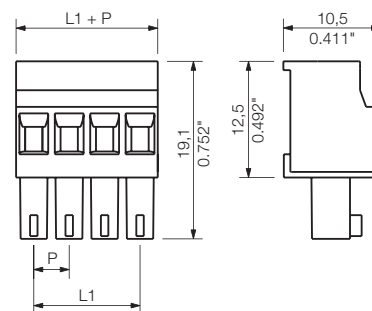

Technical data

In compliance with IEC 60664-1 / IEC 61984			
Clamping range, max.	mm ²	0.08...1.5	
Solid core H05(07) V-U	mm²	0.2...1.5	
Stranded H07 V-R			
Flexible H05(07) V-K	mm ²	0.2...1.5	
Flexible with ferrule	mm ²	0.2...1.5	
Ferrule with plastic collar	mm ²	0.2...1.5	
Stripping length	mm	7	
Screwdriver blade	mm	0.4 x 2.5	
According to norm		DIN 5264	
Tightening torque range	Nm	0.2...0.25	
Rated current, max.	A	17.5	17.5
At ambient temperature		20°C	40°C
For conductor cross-section	mm ²	1	
Overvoltage category		III	III II
Pollution severity		3	2 2
Rated voltage	V	160	160 320
Rated impulse voltage	kV	2.5	2.5 2.5
UL / CUL (Use Group)		B	C D
Rated voltage	V	300	300
Rated current	A	10	10
AWG conductor	AWG	28-16	
CSA (Use Group)		B	C D
Rated voltage	V	300	300
Rated current	A	10	10
AWG conductor	AWG	28-16	
General data			
Type of insulation material		PA GF	
UL 94 flammability rating		V-0	
Contact base material		Copper alloy	
Material of contact surface		tinned	
Pin dimensions = d	mm		
Solder eyelet Ø = D	mm		
Solder eyelet Ø tolerance	mm		

Accessories

Note: Refer to the Accessories chapter for additional accessories.

Screwdriver		Order No.
	SDIS 0.4X2.5X75	9008370000
	SDS 0.4X2.5X75	9009030000

Ordering data

Solder pin length						
Colour	Orange		Black			
Pitch	3.81 mm					
Pol.	L1	(inch)	Qty.	Order No.	Order No.	
2	3.81	0.150	50	1939820000	1798500000	
3	7.62	0.300	50	1939830000	1798120000	
4	11.43	0.450	50	1939840000	1798550000	
5	15.24	0.600	50	1939860000	1798570000	
6	19.05	0.750	50	1939870000	1798590000	
7	22.86	0.900	50	1939880000	1858960000	
8	26.67	1.050	50	1939890000	1798130000	
9	30.48	1.200	50	1939900000	1871430000	
10	34.29	1.350	50	1939910000	1798610000	
11	38.10	1.500	50	1939920000	1899380000	
12	41.91	1.650	50	1939930000	1798630000	
13	45.72	1.800	50	1939940000	1899420000	
14	49.53	1.950	50	1939950000	1899460000	
15	53.34	2.100	50	1939960000	1899500000	
16	57.15	2.250	50	1939970000	1798660000	

Representative deratings curve

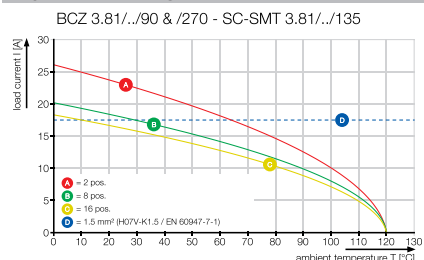

BCZ 3.81/./90F

with screw flange



Dimensioned drawing

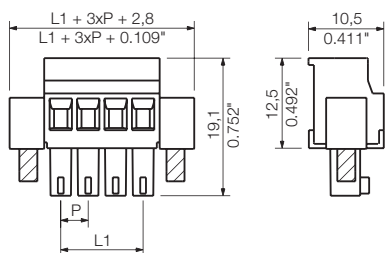

Ordering data

Solder pin length						
Colour		Orange	Black			
Pitch	3.81 mm					
Pol.	L1	(inch)	Qty.	Order No.	Order No.	
2	3.81	0.150	50	1939980000	1798780000	
3	7.62	0.300	50	1939990000	1798140000	
4	11.43	0.450	50	1940000000	1798790000	
5	15.24	0.600	50	1940010000	1798800000	
6	19.05	0.750	50	1940020000	1798810000	
7	22.86	0.900	50	1940030000	1845690000	
8	26.67	1.050	50	1940040000	1798150000	
9	30.48	1.200	50	1940050000	1899540000	
10	34.29	1.350	50	1940060000	1798820000	
11	38.10	1.500	50	1940070000	1899560000	
12	41.91	1.650	50	1940080000	1798830000	
13	45.72	1.800	50	1940090000	1899580000	
14	49.53	1.950	50	1940100000	1899600000	
15	53.34	2.100	50	1940110000	1899620000	
16	57.15	2.250	50	1940120000	1798840000	

BCZ 3.81/./270

with screw flange



Dimensioned drawing

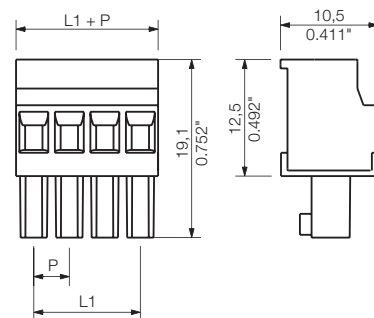

Ordering data

Solder pin length						
Colour		Orange	Black			
Pitch	3.81 mm					
Pol.	L1	(inch)	Qty.	Order No.	Order No.	
2	3.81	0.150	50	1940190000	1798940000	
3	7.62	0.300	50	1940200000	1798160000	
4	11.43	0.450	50	1940210000	1798950000	
5	15.24	0.600	50	1940220000	1798960000	
6	19.05	0.750	50	1940230000	1798970000	
7	22.86	0.900	50	1940240000	1940400000	
8	26.67	1.050	50	1940250000	1798170000	
9	30.48	1.200	50	1940260000	1940410000	
10	34.29	1.350	50	1940270000	1798980000	
11	38.10	1.500	50	1940280000	1940420000	
12	41.91	1.650	50	1940290000	1798990000	
13	45.72	1.800	50	1940300000	1940430000	
14	49.53	1.950	50	1940310000	1940440000	
15	53.34	2.100	50	1940320000	1940450000	
16	57.15	2.250	50	1940330000	1799000000	

BCZ 3.81/./270F

with screw flange

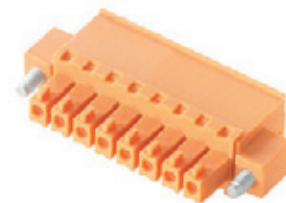

Dimensioned drawing

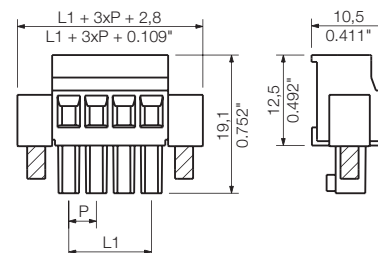

Ordering data

Solder pin length						
Colour		Orange	Black			
Pitch	3.81 mm					
Pol.	L1	(inch)	Qty.	Order No.	Order No.	
2	3.81	0.150	50	1940460000	1799100000	
3	7.62	0.300	50	1940470000	1798180000	
4	11.43	0.450	50	1940480000	1799110000	
5	15.24	0.600	50	1940490000	1799120000	
6	19.05	0.750	50	1940500000	1799130000	
7	22.86	0.900	50	1940510000	1940670000	
8	26.67	1.050	50	1940520000	1798190000	
9	30.48	1.200	50	1940530000	1940680000	
10	34.29	1.350	50	1940540000	1799140000	
11	38.10	1.500	50	1940550000	1940690000	
12	41.91	1.650	50	1940560000	1799150000	
13	45.72	1.800	50	1940570000	1940700000	
14	49.53	1.950	50	1940580000	1940710000	
15	53.34	2.100	50	1940590000	1940720000	
16	57.15	2.250	50	1940600000	1799160000	

Additional deratings curves

BCZ 3.81/./90 & /270 - SC 3.81/./135

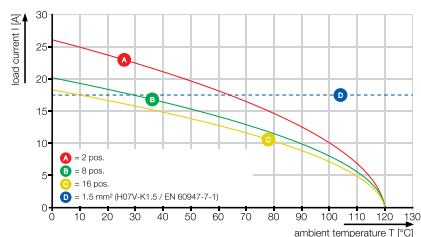

BCF 3.81../180

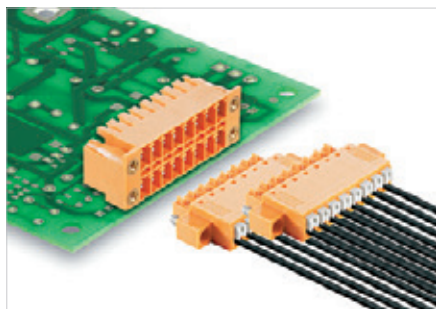

Female plug with PUSH IN wire connection.

- Simply insert the wire and it's ready.
- Integrated push-button for opening the terminal point
- High component density because of very low height, especially when combined with the compact double-level SCDN / SCDN-THR male header.
- Available in closed version, with screw flange (F) and lock an release-lever (LR).

Weidmüller's 3.81 mm pitch (0.15 inch) plug-in connectors are compatible with the layouts of standard connectors and offer space for labelling and coding.

Technical data

In compliance with IEC 60664-1 / IEC 61984			
Clamping range, max.	mm ²	0.14...1.5	
Solid core H05(07) V-U	mm²	0.14...1.5	
Stranded H07 V-R			
Flexible H05(07) V-K	mm ²	0.14...1.5	
Flexible with ferrule	mm ²	0.2...1.5	
Ferrule with plastic collar	mm ²	0.2...1.5	
Stripping length	mm	8	
Screwdriver blade	mm	0.4 x 2.5	
According to norm		DIN 5264	
Tightening torque range	Nm		
Rated current, max.	A	17.5	17.5
At ambient temperature		20°C	40°C
For conductor cross-section	mm ²	1	
Overvoltage category		III	III II
Pollution severity		3	2 2
Rated voltage	V	160	160 320
Rated impulse voltage	kV	2.5	2.5 2.5
UL / CUL (Use Group)		B	C D
Rated voltage	V	300	300
Rated current	A	10	10
AWG conductor	AWG	26-16	
CSA (Use Group)		B	C D
Rated voltage	V	300	300
Rated current	A	10	10
AWG conductor	AWG	26-16	
General data			
Type of insulation material		PA 66 GF 30	
UL 94 flammability rating		V-0	
Contact base material		Copper alloy	
Material of contact surface		tinned	
Pin dimensions = d	mm		
Solder eyelet Ø = D	mm		
Solder eyelet Ø tolerance	mm		

Product data

IEC: 320 V / 17.5 A / 0.14 - 1.5 mm²
UL: 300 V / 10 A / AWG 26 - 16

For additional articles and information, refer to catalog.weidmueller.com

Note:

- Additional colours on request
- Gold-plated contact surfaces on request
- Crimp shape A for wire-end ferrules with crimping tools PZ 1.5 (order no. 9005990000) or PZ 6/5 (order no. 9011460000) for larger wire cross-sections recommended.
- Rated current related to rated cross-section & min. No. of poles.
- Wire end ferrule without plastic collar to DIN 46228/1
- Wire end ferrule with plastic collar to DIN 46228/4
- P on drawing = pitch
- Rated data refer only to the component itself. Clearance and creepage distances to other components are to be designed in accordance with the relevant application standards.

BCF 3.81../180



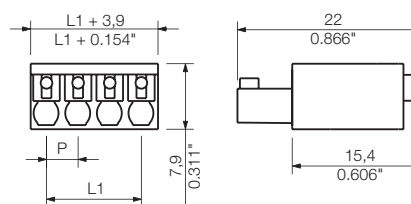

Dimensioned drawing



Accessories

Note: Refer to the Accessories chapter for additional accessories.

Screwdriver		Order No.
	SDIS 0.4X2.5X75	9008370000
	SDS 0.4X2.5X75	9009030000
Crimping tool		
	PZ 1.5	9005990000
	PZ 6/5	9011460000

Ordering data

Solder pin length						
Colour	Orange		Black			
Pitch	3.81 mm					
Pol.	L1	(inch)	Qty.	Order No.	Order No.	
2	3.81	0.150	50	1969090000	1969890000	
3	7.62	0.300	50	1969100000	1969920000	
4	11.43	0.450	50	1969110000	1969950000	
5	15.24	0.600	50	1969120000	1969970000	
6	19.05	0.750	50	1969130000	1969980000	
7	22.86	0.900	50	1969140000	1969990000	
8	26.67	1.050	50	1969150000	1970000000	
9	30.48	1.200	50	1969160000	1970040000	
10	34.29	1.350	50	1969170000	1970130000	
11	38.10	1.500	50	1969180000	1970170000	
12	41.91	1.650	50	1969190000	1970190000	
13	45.72	1.800	50	1969200000	1970200000	
14	49.53	1.950	50	1969210000	1970210000	
15	53.34	2.100	50	1969220000	1970220000	
16	57.15	2.250	50	1969230000	1970230000	
17	60.96	2.400	50	1969240000	1970240000	
18	64.77	2.550	50	1969250000	1970250000	

Representative deratings curve

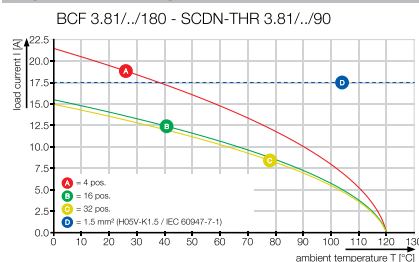

BCF 3.81../180F

with screw flange



Dimensioned drawing

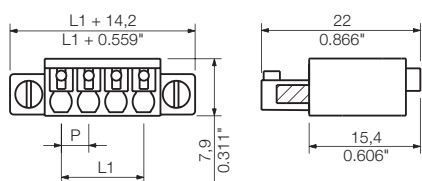

Ordering data

Solder pin length					
Colour	Orange	Black			
Pitch	3.81 mm				
Pol.	L1 (inch)	Qty.	Order No.	Order No.	
2	3.81	0.150	50	1970300000	1971500000
3	7.62	0.300	50	1970330000	1971570000
4	11.43	0.450	50	1970370000	1971590000
5	15.24	0.600	50	1970380000	1971620000
6	19.05	0.750	50	1970400000	1971650000
7	22.86	0.900	50	1970440000	1971780000
8	26.67	1.050	50	1970550000	1971830000
9	30.48	1.200	50	1970570000	1971850000
10	34.29	1.350	50	1970580000	1971870000
11	38.10	1.500	50	1970620000	1971900000
12	41.91	1.650	50	1970650000	1971940000
13	45.72	1.800	50	1970690000	1971970000
14	49.53	1.950	50	1970730000	1972000000
15	53.34	2.100	50	1970750000	1972030000
16	57.15	2.250	50	1970820000	1972070000
17	60.96	2.400	50	1970850000	1972100000
18	64.77	2.550	50	1970890000	1972170000

BCF 3.81../180LR

with release latch



Dimensioned drawing

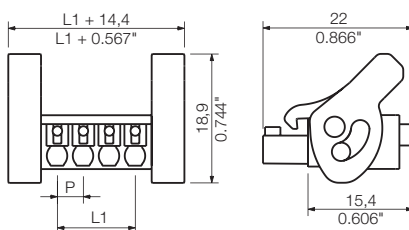

Ordering data

Solder pin length					
Colour	Orange	Black			
Pitch	3.81 mm				
Pol.	L1 (inch)	Qty.	Order No.	Order No.	
2	3.81	0.150	50	1972200000	1972600000
3	7.62	0.300	50	1972210000	1972610000
4	11.43	0.450	50	1972220000	1972620000
5	15.24	0.600	50	1972230000	1972630000
6	19.05	0.750	50	1972240000	1972640000
7	22.86	0.900	50	1972250000	1972650000
8	26.67	1.050	50	1972260000	1972660000
9	30.48	1.200	50	1972270000	1972670000
10	34.29	1.350	50	1972280000	1972680000
11	38.10	1.500	50	1972290000	1972690000
12	41.91	1.650	50	1972300000	1972700000
13	45.72	1.800	50	1972310000	1972710000
14	49.53	1.950	50	1972320000	1972720000
15	53.34	2.100	50	1972330000	1972730000
16	57.15	2.250	50	1972340000	1972740000
17	60.96	2.400	50	1972350000	1972750000
18	64.77	2.550	50	1972360000	1972760000

Additional deratings curves

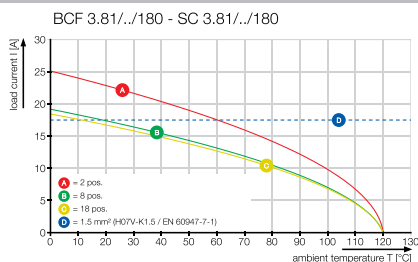
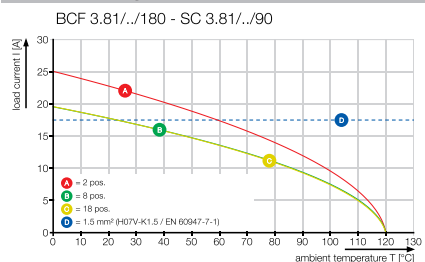

BCF 3.81/./180 ZE

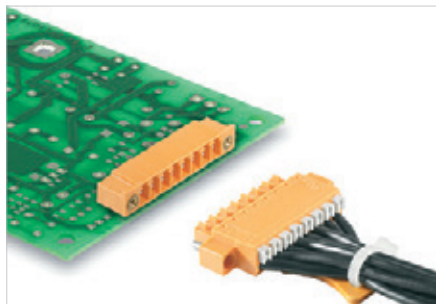

Female plug with strain relief (ZE) for the connected cable.

- PUSH IN wire connection method
- Simply insert the prepared wire and attach the strain relief mechanism
- Intuitive handling - since the wire-entry area and handling area are clearly separated.

Weidmüller's 3.81 mm pitch (0.15 inch) plug-in connectors are compatible with the layouts of standard connectors and offer space for labelling and coding.

Technical data

In compliance with IEC 60664-1 / IEC 61984			
Clamping range, max.	mm ²	0.14...1.5	
Solid core H05(07) V-U	mm²	0.14...1.5	
Stranded H07 V-R			
Flexible H05(07) V-K	mm ²	0.14...1.5	
Flexible with ferrule	mm ²	0.2...1.5	
Ferrule with plastic collar	mm ²	0.2...1.5	
Stripping length	mm	8	
Screwdriver blade	mm	0.4 x 2.5	
According to norm		DIN 5264	
Tightening torque range	Nm		
Rated current, max.	A	17.5	17.5
At ambient temperature		20°C	40°C
For conductor cross-section	mm ²		
Overvoltage category		III	III II
Pollution severity		3	2 2
Rated voltage	V	160	160 320
Rated impulse voltage	kV	2.5	2.5 2.5
UL / CUL (Use Group)		B	C D
Rated voltage	V	300	300
Rated current	A	10	10
AWG conductor	AWG	24-16	
CSA (Use Group)		B	C D
Rated voltage	V	300	300
Rated current	A	10	10
AWG conductor	AWG	24-16	
General data			
Type of insulation material		PA 66 GF 30	
UL 94 flammability rating		V-0	
Contact base material		Copper alloy	
Material of contact surface		tinned	
Pin dimensions = d	mm		
Solder eyelet Ø = D	mm		
Solder eyelet Ø tolerance	mm		

Product data

IEC: 320 V / 17.5 A / 0.14 - 1.5 mm²
UL: 300 V / 10 A / AWG 24 - 16

For additional articles and information, refer to catalog.weidmueller.com

- Note:**
- Additional colours on request
 - Gold-plated contact surfaces on request
 - Crimp shape A for wire-end ferrules with crimping tools PZ 1.5 (order no. 9005990000) or PZ 6/5 (order no. 9011460000) for larger wire cross-sections recommended.
 - Rated current related to rated cross-section & min. No. of poles.
 - Wire end ferrule without plastic collar to DIN 46228/1
 - Wire end ferrule with plastic collar to DIN 46228/4
 - P on drawing = pitch
 - Rated data refer only to the component itself. Clearance and creepage distances to other components are to be designed in accordance with the relevant application standards.

BCF 3.81/./180ZE

with strain relief



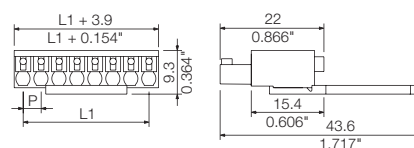

Dimensioned drawing



Accessories

Note: Refer to the Accessories chapter for additional accessories.

Screwdriver		Order No.
	SDIS 0.4X2.5X75	9008370000
	SDS 0.4X2.5X75	9009030000
Crimping tool		
	PZ 1.5	9005990000
	PZ 6/5	9011460000

Ordering data

Solder pin length						
Colour	Orange		Black			
Pitch	3.81 mm					
Pol.	L1	(inch)	Qty.	Order No.	Order No.	
5	15.24	0.600	50	1235790000	1231680000	
6	19.05	0.750	50	1235800000	1231690000	
7	22.86	0.900	50	1235810000	1231710000	
8	26.67	1.050	50	1235820000	1231720000	
9	30.48	1.200	50	1235830000	1231730000	
10	34.29	1.350	50	1235840000	1231740000	
11	38.10	1.500	50	1235870000	1231750000	
12	41.91	1.650	50	1235880000	1231760000	
13	45.72	1.800	50	1235890000	1231770000	
14	49.53	1.950	50	1235900000	1231780000	
15	53.34	2.100	50	1235910000	1231790000	
16	57.12	2.250	50	1235920000	1231810000	
17	60.96	2.400	50	1235930000	1231820000	
18	64.77	2.550	50	1235940000	1231830000	

from 10 pole 2 strain reliefs per plug-in connector

Representative deratings curve

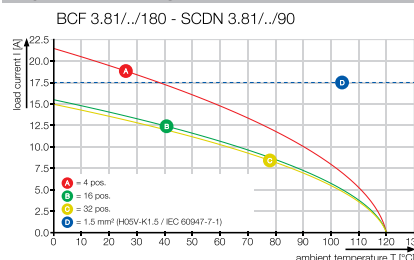

from 10 pole 2 strain reliefs per plug-in connector

BCF 3.81../180FZE

with screw flange and strain relief



Dimensioned drawing

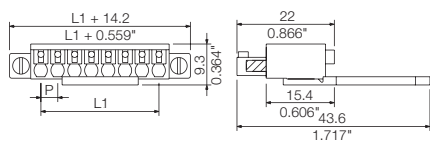

BCF 3.81../180LRZE

with release latch and strain relief



Dimensioned drawing

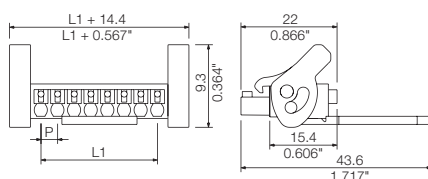

Ordering data

Solder pin length					
Colour	Orange		Black		
Pitch	3.81 mm				
Pol.	L1	(inch)	Qty.	Order No.	Order No.
5	15.24	0.600	50	1235970000	1231350000
6	19.05	0.750	50	1235980000	1231360000
7	22.86	0.900	50	1235990000	1231370000
8	26.67	1.050	50	1236000000	1231380000
9	30.48	1.200	50	1236010000	1231390000
10	34.29	1.350	50	1236020000	1231410000
11	38.10	1.500	50	1236030000	1231420000
12	41.91	1.650	50	1236040000	1231430000
13	45.72	1.800	50	1236050000	1231440000
14	49.53	1.950	50	1236070000	1231450000
15	53.34	2.100	50	1236080000	1231460000
16	57.12	2.250	50	1236090000	1231470000
17	60.96	2.400	50	1236100000	1231480000
18	64.77	2.550	50	1236110000	1231490000

Ordering data

Solder pin length					
Colour	Orange		Black		
Pitch	3.81 mm				
Pol.	L1	(inch)	Qty.	Order No.	Order No.
5	15.24	0.600	50	1236120000	1231520000
6	19.05	0.750	50	1236130000	1231530000
7	22.86	0.900	50	1236140000	1231540000
8	26.67	1.050	50	1236150000	1231550000
9	30.48	1.200	50	1236160000	1231560000
10	34.29	1.350	50	1236170000	1231570000
11	38.10	1.500	50	1236180000	1231580000
12	41.91	1.650	50	1236190000	1231590000
13	45.72	1.800	50	1236200000	1231610000
14	49.53	1.950	50	1236210000	1231620000
15	53.34	2.100	50	1236220000	1231630000
16	57.12	2.250	50	1236230000	1231640000
17	60.96	2.400	50	1236240000	1231650000
18	64.77	2.550	50	1236250000	1231660000

from 10 pole 2 strain reliefs per plug-in connector

from 10 pole 2 strain reliefs per plug-in connector

Additional deratings curves

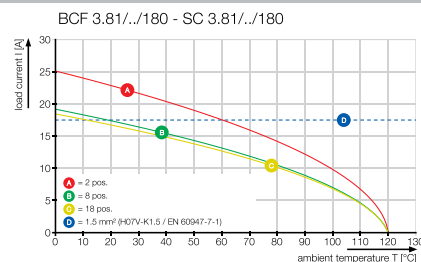
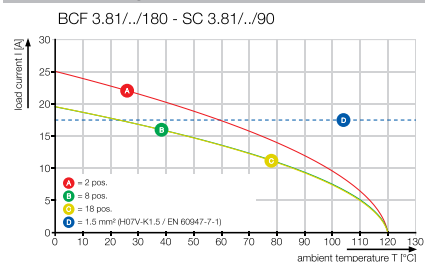

BCL-SMT 3.81/./90

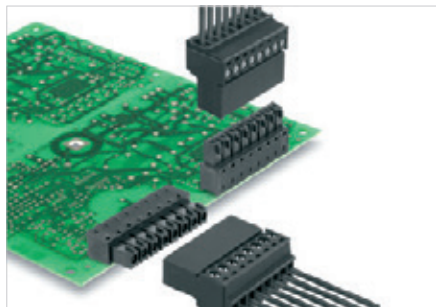

Inverted female headers for:

- Touch-safety on the circuit board with board-to-wire connection (with the SCZ)
- Board-to-board component connection (with SC/SC-SMT)
- Works with reflow soldering and automatic placement.
- Orientation: 90°
- Available in closed version with screw Flange (F) and inverted solder flange (LFI).

Weidmüller's 3.81 mm pitch (0.15 inch) plug-in connectors are compatible with the layouts of standard connectors and offer space for labelling and coding.

Technical data

In compliance with IEC 60664-1 / IEC 61984

Clamping range, max.	mm ²		
Solid core H05(07) V-U	mm²		
Stranded H07 V-R			
Flexible H05(07) V-K	mm ²		
Flexible with ferrule	mm ²		
Ferrule with plastic collar	mm ²		
Stripping length	mm		
Screwdriver blade	mm		
According to norm			
Tightening torque range	Nm		
Rated current, max.	A	17.5	17.5
At ambient temperature		20°C	40°C
For conductor cross-section	mm ²		
Overtolerance category		III	III II
Pollution severity		3	2 2
Rated voltage	V	160	160 320
Rated impulse voltage	kV	2.5	2.5 2.5
UL / CUL (Use Group)	B C D		
Rated voltage	V	300	300
Rated current	A	10	10
AWG conductor	AWG		
CSA (Use Group)	B C D		
Rated voltage	V	300	300
Rated current	A	10	10
AWG conductor	AWG		
General data			
Type of insulation material		LCP GF	
UL 94 flammability rating		V-0	
Contact base material		Copper alloy	
Material of contact surface		tinned	
Pin dimensions = d	mm	0.8	
Solder eyelet Ø = D	mm	1.2	
Solder eyelet Ø tolerance	mm	+ 0,1	

Product data

IEC: 320 V / 17.5 A
UL: 300 V / 10 A

For additional articles and information, refer to catalog.weidmueller.com

Note:

- Gold-plated contact surfaces on request
- Rated current related to rated cross-section & min. No. of poles.
- P on drawing = pitch
- Rated data refer only to the component itself. Clearance and creepage distances to other components are to be designed in accordance with the relevant application standards.

BCL-SMT 3.81/./90



Dimensioned drawing

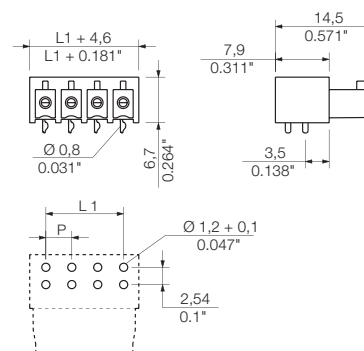

Accessories

Note: Refer to the Accessories chapter for additional accessories.

Ordering data

Solder pin length		1.5 mm		
Colour		Black		
Pitch		3.81 mm		
Pol.	L1	(inch)	Qty.	Order No.
2	3.81	0.150	50	1974750000
3	7.62	0.300	50	1974770000
4	11.43	0.450	50	1974780000
5	15.24	0.600	50	1974800000
6	19.05	0.750	50	1974820000
7	22.86	0.900	50	1974840000
8	26.67	1.050	50	1974850000
9	30.48	1.200	50	1974880000
10	34.29	1.350	50	1974890000
11	38.10	1.500	50	1974910000
12	41.91	1.650	50	1974930000

Representative deratings curve

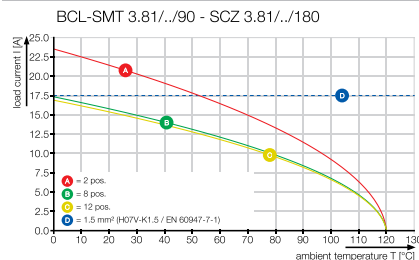

BCL-SMT 3.81/./90LFI

with inverted solder flange



BCL-SMT 3.81/./90F

with screw flange



Dimensioned drawing

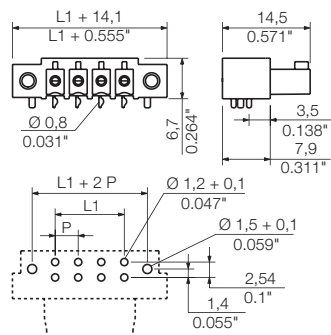

Dimensioned drawing

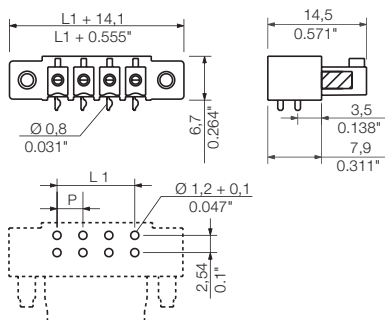

Ordering data

Solder pin length		1.5 mm	
Colour		Black	
Pitch		3.81 mm	
Pol.	L1	(inch)	Qty. Order No.
2	3.81	0.150	50 1028720000
3	7.62	0.300	50 1028730000
4	11.43	0.450	50 1028740000
5	15.24	0.600	50 1028750000
6	19.05	0.750	50 1028760000
7	22.86	0.900	50 1028770000
8	26.67	1.050	50 1028790000
9	30.48	1.200	50 1028810000
10	34.29	1.350	50 1028820000
11	38.10	1.500	50 1028830000
12	41.91	1.650	50 1028840000

Ordering data

Solder pin length		1.5 mm	
Colour		Black	
Pitch		3.81 mm	
Pol.	L1	(inch)	Qty. Order No.
2	3.81	0.150	50 1975690000
3	7.62	0.300	50 1975700000
4	11.43	0.450	50 1975710000
5	15.24	0.600	50 1975730000
6	19.05	0.750	50 1975740000
7	22.86	0.900	50 1975750000
8	26.67	1.050	50 1975760000
9	30.48	1.200	50 1975780000
10	34.29	1.350	50 1975790000
11	38.10	1.500	50 1975820000
12	41.91	1.650	50 1975830000

Additional deratings curves

BCL-SMT 3.81/./90 - SCZ 3.81/./180

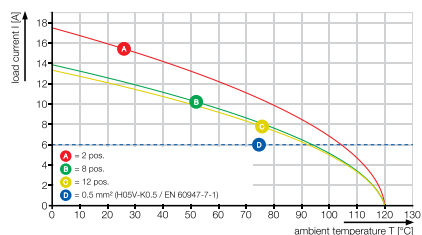

BCL-SMT 3.81../180

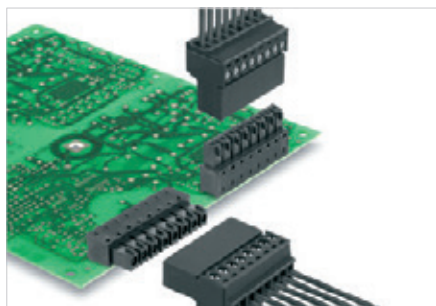

Inverted female headers for:

- Touch-safety on the circuit board with board-to-wire (when connecting with the SCZ)
- Board-to-board component connection (with SC/SC-SMT)
- Works with reflow soldering and automatic placement.
- Orientation: 180°
- Available in closed version and with inverted solder flange (LFI).

Weidmüller's 3.81 mm pitch (0.15 inch) plug-in connectors are compatible with the layouts of standard connectors and offer space for labelling and coding.

Technical data

In compliance with IEC 60664-1 / IEC 61984

Clamping range, max.	mm ²		
Solid core H05(07) V-U	mm²		
Stranded H07 V-R			
Flexible H05(07) V-K	mm ²		
Flexible with ferrule	mm ²		
Ferrule with plastic collar	mm ²		
Stripping length	mm		
Screwdriver blade	mm		
According to norm			
Tightening torque range	Nm		
Rated current, max.	A	17.5	17.5
At ambient temperature		20°C	40°C
For conductor cross-section	mm ²		
Overtolerance category		III	III II
Pollution severity		3	2 2
Rated voltage	V	160	160 320
Rated impulse voltage	kV	2.5	2.5 2.5
UL / CUL (Use Group)	B C D		
Rated voltage	V	300	300
Rated current	A	10	10
AWG conductor	AWG		
CSA (Use Group)	B C D		
Rated voltage	V	300	300
Rated current	A	10	10
AWG conductor	AWG		
General data			
Type of insulation material		LCP GF	
UL 94 flammability rating		V-0	
Contact base material		Copper alloy	
Material of contact surface		tinned	
Pin dimensions = d	mm	0.8	
Solder eyelet Ø = D	mm	1.2	
Solder eyelet Ø tolerance	mm	+ 0,1	

Product data

IEC: 320 V / 17.5 A
UL: 300 V / 10 A

For additional articles and information, refer to catalog.weidmueller.com

Note:

- Gold-plated contact surfaces on request
- Rated current related to rated cross-section & min. No. of poles.
- P on drawing = pitch
- Rated data refer only to the component itself. Clearance and creepage distances to other components are to be designed in accordance with the relevant application standards.

BCL-SMT 3.81../180



Dimensioned drawing

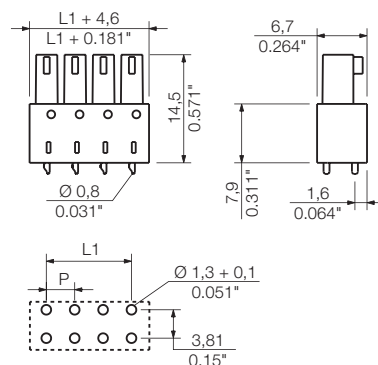

Accessories

Note: Refer to the Accessories chapter for additional accessories.

Ordering data

Solder pin length		1.5 mm		
Colour		Black		
Pitch		3.81 mm		
Pol.	L1	(inch)	Qty.	Order No.
2	3.81	0.150	50	1976490000
3	7.62	0.300	50	1976500000
4	11.43	0.450	50	1976520000
5	15.24	0.600	50	1976530000
6	19.05	0.750	50	1976550000
7	22.86	0.900	50	1976570000
8	26.67	1.050	50	1976580000
9	30.48	1.200	50	1976590000
10	34.29	1.350	50	1976610000
11	38.10	1.500	50	1976620000
12	41.91	1.650	50	1976640000

Representative deratings curve

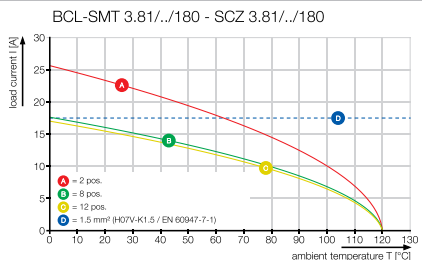

BCL-SMT 3.81../180FI

with inverted solder flange



Dimensioned drawing

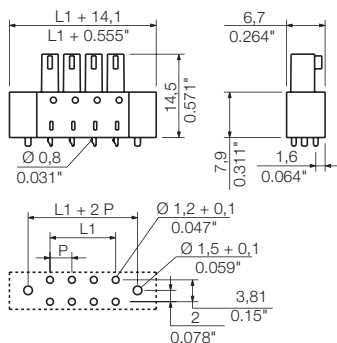

Ordering data

Solder pin length		1.5 mm		
Colour		Black		
Pitch		3.81 mm		
Pol.	L1	(inch)	Qty.	Order No.
2	3.81	0.150	50	1029260000
3	7.62	0.300	50	1029270000
4	11.43	0.450	50	1029280000
5	15.24	0.600	50	1029290000
6	19.05	0.750	50	1029310000
7	22.86	0.900	50	1029320000
8	26.67	1.050	50	1029330000
9	30.48	1.200	50	1029340000
10	34.29	1.350	50	1029350000
11	38.10	1.500	50	1029360000
12	41.91	1.650	50	1029370000

Additional deratings curves

BCL-SMT 3.81../180 - SCZ 3.81../180

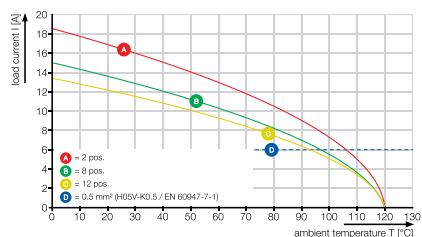

Male header SL-SMT 5.0x and SL-SMaRT 5.0x

The connecting element in the reflow process

Optimiert für SMT (Surface Mount Technology)

C

Innovative, application oriented male headers made from high temperature insulating material LCP (Liquid crystal polymer) permits seamless integration of the connections into the automated SMT production process, including reflow soldering.

The comprehensive portfolio impresses with significant gains in efficiency in assembly production, i.e. a reduction of manufacturing costs of up to 30 %, with increased process security and proven reliability.

Absolute process reliability

Using glass-fibre reinforced plastic with the SL 5.08 HC and SL-SMT 5.08 pin headers ensures a high level of dimensional stability and prevents what is known as the „banana effect“ – the printed-circuit board sagging – in the soldering process.

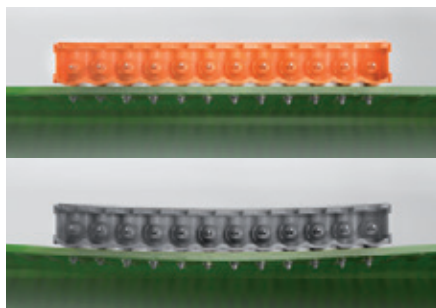

Standard-compliant fixing

More use with less effort: the soldering flange reduces 3 steps to one while protecting the soldering points from regular mechanical stress. A uniform drill hole diameter, no fixing of the fastening screw – additional fastening takes place automatically in the soldering process.

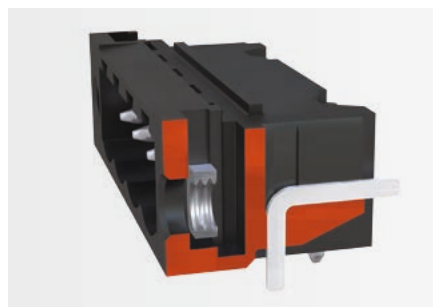

SL-SMaRT: designed for automatic machine assembly

All pole numbers on board – only 2 articles on the bearing/in the feeder. The strategy of self-adjusting 2- and 3-pole pin header modules not only reduces the variety, but also the costs. The fact that it can be processed without a pick & place pad boosts process reliability and efficiency even more.



Delivered to fit your process:

Tape packaging with optimised tape pockets customised to match the width and pole count: this ensures that the feeders are used optimally and that the male headers are securely positioned on the tape.



Specified to fit your application:

1.5 mm short pins for flush solder joints permit PCB assembly on both sides in accordance with IPC A-610 and also reduces the solder paste volume significantly. At the same time, the required stroke length of the Pick & Place machine is reduced to a minimum. As an alternative, 3.2 mm pins are available for PCBs thicker than 1.6 mm.

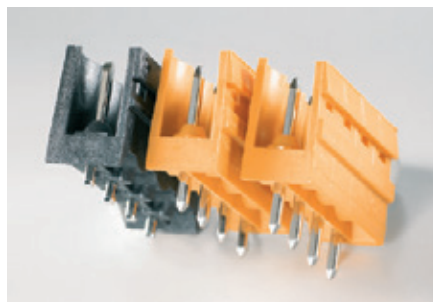

Male header SL 5.0x

Optimised for wave soldering

C

These male headers in 5.00 mm and 5.08 mm pitch with the characteristic wave design in the mating face are the standard headers used in industrial automation. This male header has already enjoyed decades of market success; it is the basis for device connection systems for both wave and manual soldering.

Increased density for device connections:
You can maximise connection density by using doublelevel male headers together with your choice of connection systems on the field side.

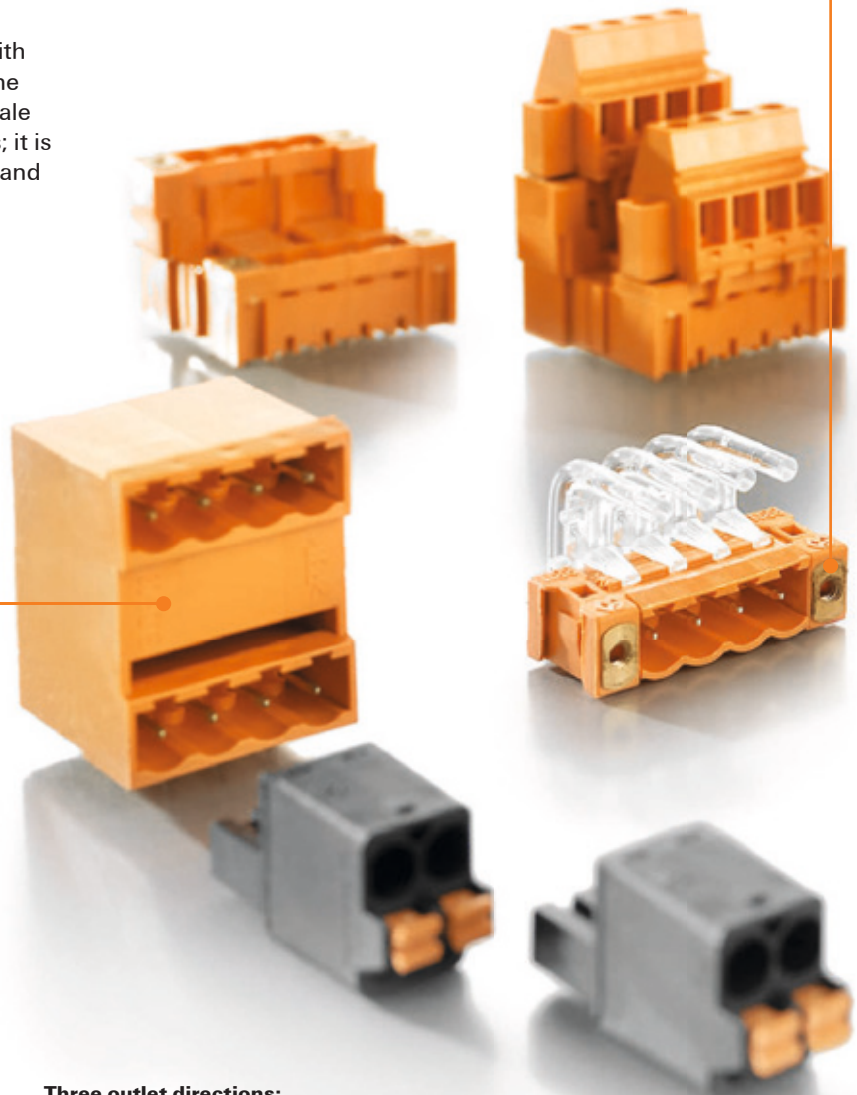
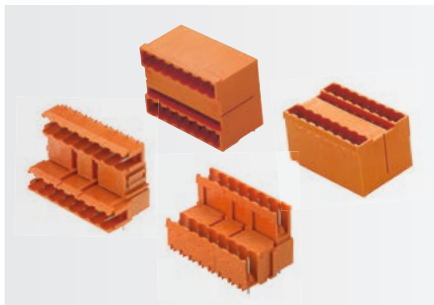

Three outlet directions:
There are more device design possibilities created by the different conductor path angles.

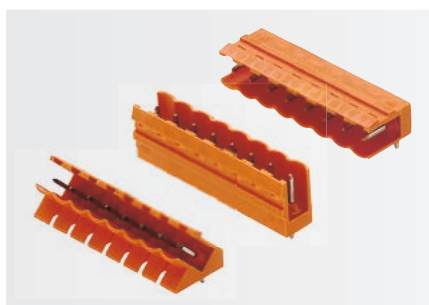

Safe under vibration and shock

- Vibration proof connection between male header and female plug
- The male header can also be screwed to the PCB
- Available with gold-plated surfaces

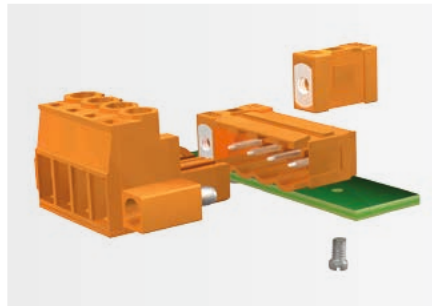

Specified to fit your assembly process

Gold-plated male headers have gold plating on the functional surfaces but not on the solder surfaces. This prevents contamination of the solder bath.

C



Integrated to fit your design

Adaptable connection system - the colour of the plug connectors fits to the device design and not the other way around.



Extensive accessories

- Light guides carry signals from the PCB LEDs to the front plate
- Partitions can be used to visually separate the different functional areas of the male header.
- All male headers can be manually coded or ordered as pre-coded headers.

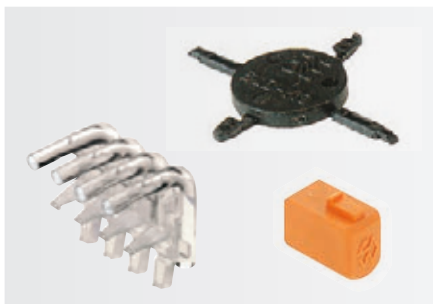

Female plug BLZP 5.0x

Pluggable, universal screw connection



C

The BLZP is the functional extension of the BLZ series, which has proven itself on the market for decades.

The "P" in the part name stands for an increase in security and efficiency in both fabrication and use. Resulting from this are additional customer benefits, such as a continuous function and safety chain, increased efficiency and process reliability and much more user friendly operation.

Folded steel clamping yoke

When the screw on the clamp is tightened, there is a counter effect in the clamping yoke's threaded area. This ensures a maintenance free and durable gas-tight connection. In addition, the elastic behaviour of the clamping yoke compensates for the setting of the connected wire and any temperature induced deviations.



Hybrid contacts

The current bar and the tulip contact are made from two different materials and then welded together. The current bar has high conductivity and the tulip contact is characterised by its excellent spring properties.



Safe connection – error-free wiring

The integrated "wire guard" feature prevents dangerous insertion of the wire below the clamping area and thus protects against contact or insertion errors.



Safe contacting – universal operation

The globally compatible screw head (in conformity with ISO 2880/2, ISO 8764/2-PH and ISO 8764/2-PHZ) that fits all tools – for non-positive and uncomplicated operation with common hand tools or the efficient use of power tools.

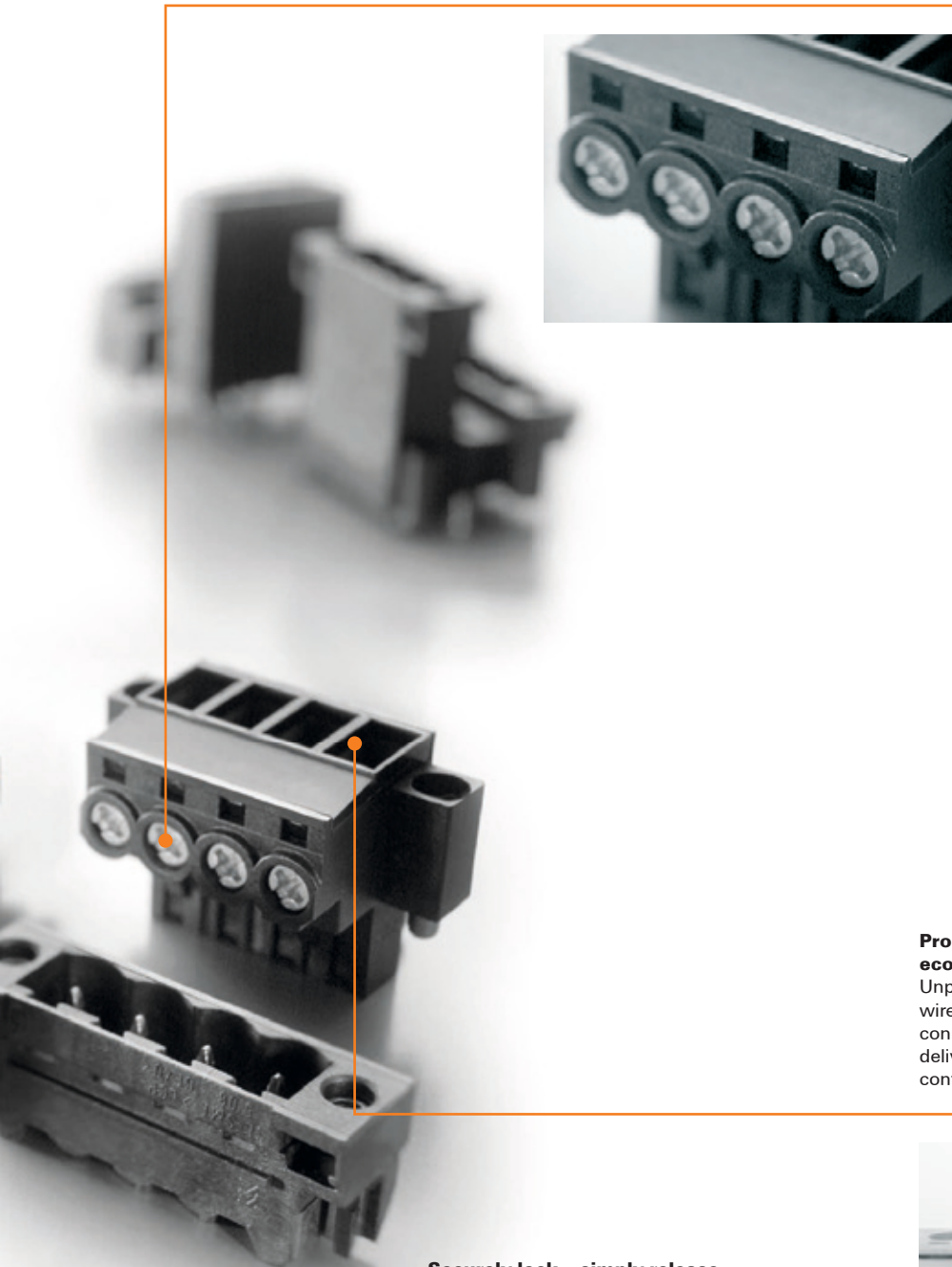

Conductor outlet direction up/down



Conductor outlet direction straight/inclined



Locking options

F = screw flange / LR = Lock & Release lever

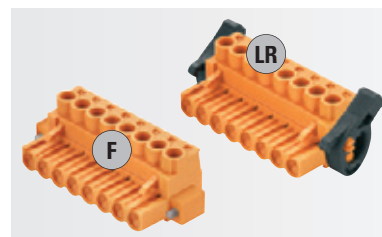

Process-compatible by default – economical processing

Unpack – wire ready – connect up. Our wire-ready technology makes sure that all connecting points are completely opened when delivered, even after global transport (in conformity with ISO 13355).

Securely lock – simply release

Fast, self-locking with the male header for tool-free handling. Releasing of the female plug is gentle on components.

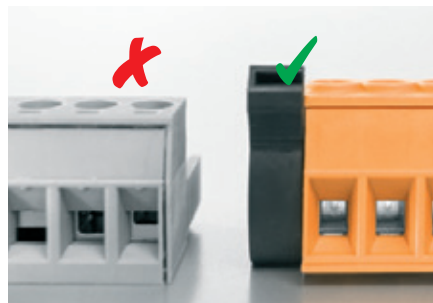

Female plug BLT 5.08

The specialist for tight installation spaces

C

The BLT range is the most compact TOP connection of its type available in 5.08 mm pitch. This greatly simplifies device design because the cable entry and screw are located in the same plane of the plug-in connector. With the wire connection parallel to the circuit board, the BLT is specialised for use in limited installation spaces and high packing densities.

High component density

Normal screw terminals have a 90° angle between the directions of the cable entry and the screw. The required space must then be taken into account when designing the device. However with the TOP connection system, the directions for wire entry and clamping operations are the same.

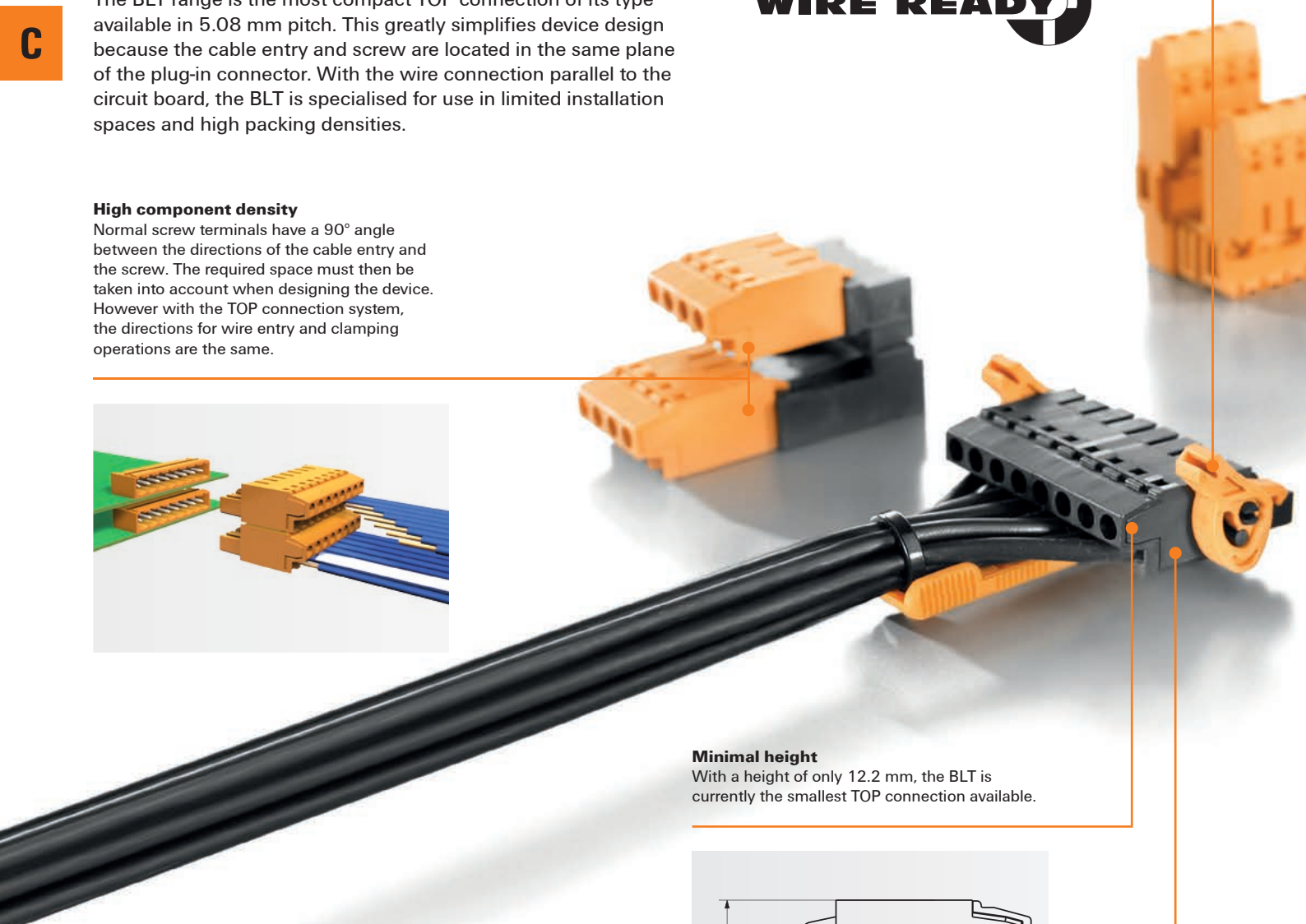
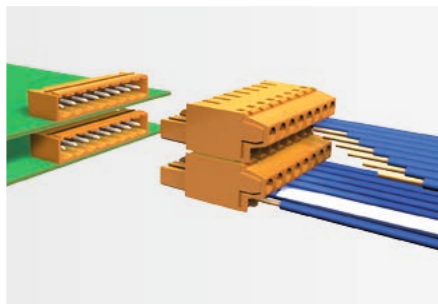

Minimal height

With a height of only 12.2 mm, the BLT is currently the smallest TOP connection available.

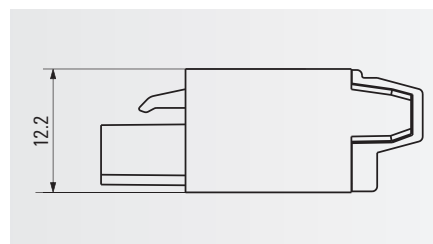

Secure interlock and simple release

Fast, self-locking with the male header for tool-free handling. Releasing of the female plug is gentle on components.



Process-compatible by default – economical processing

Unpack – “Wire Ready” – Connect. The “Wire Ready” technology ensures that all clamping units are fully open on delivery, even after world-wide shipping.

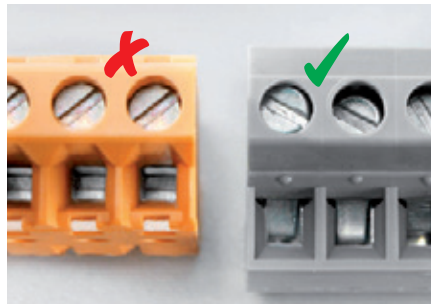
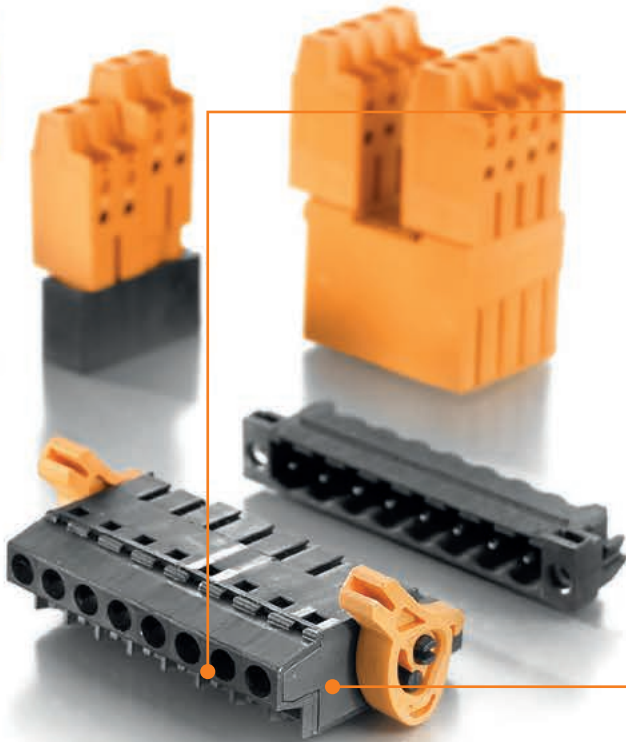

Safe to use with no-fault wiring:

The BLT’s “pull effect” ensures that the connected wire is pulled in to the clamping point for a securely established contact.



Hybrid contacts

For every function, the best material. The current bar and the tulip contact are made from two different materials and then welded together. The current bar has high conductivity and the tulip contact is characterised by its excellent spring properties.



Female plug BLF 5.0x and BLDF 5.08 PUSH IN for fast conductor connection without any tools



The quick PUSH IN connection is now also available in pitches of 5.00 mm and 5.08 mm. The products are simple, safe and can be used in a variety of applications: The plugs are available for all wire outlet directions (90°, 180° and 270°) and also as a double connector with integrated cross-connection for bus applications. The hybrid contacts used in combination with PUSH IN guarantee a vibration resistant and maintenance free connection, even under extreme conditions.

Hybrid contacts

The current bar and the tulip contact are made from two different materials and then welded together. The current bar has high conductivity and the tulip contact is characterised by its excellent spring properties.



All-purpose usage:

Very large clamping range from 0.2 mm² to 2.5 mm² –even when using ferrules with plastic collars.

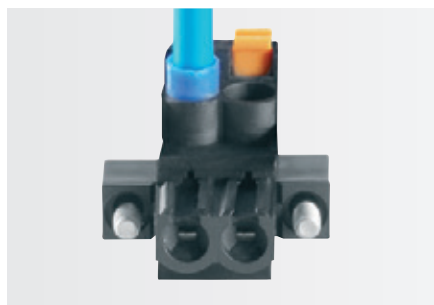

Can be tested at any time:
Simplified functional testing using easily accessible diagnostic test points.



Safe to operate

Rounded edges and large, non-slip control buttons ensure user-friendly operation.



Extremely durable

The integrated cross-connector is designed for a low voltage drop and allows a powerful 22 A bus power which can supply a high number of notes in the bus system.

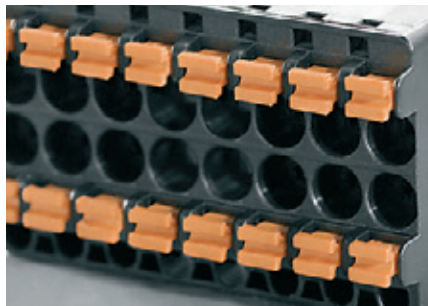

All-round safety

A stainless steel cage enclosure prevents subsidence in the contact area. To prevent any drop in clamping force plastic parts were deliberately not used.



Directly plugged in

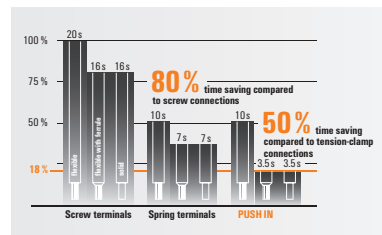

Simply fast

PUSH IN: tool-free connections of pre-prepared wires into the wire-entry funnel. www.PUSH-IN.com

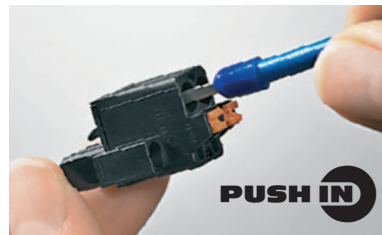

Simple and self-explanatory

Intuitive opening of the terminal point using conspicuous push buttons.

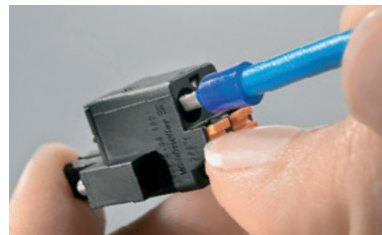

Female plug BLC 5.08

Cost effective and pre-assembled using a crimp connection

C

The BLC product family with crimp connections provides an affordable solution with pre-assembled female plugs that is also appropriate for large batch jobs. The contacts can be crimped by using hand tools or with a crimping machine in the factory when producing large batches.

Effective and cost-effective

By using high performance metals, a costly over-spring on the tulip contact can be avoided. This cost saving is passed directly to the customer.

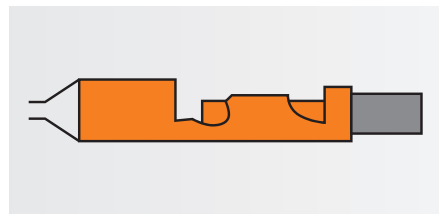

Minimal height

With a height of only 12.2 mm, the BLT is currently the smallest TOP connection available.

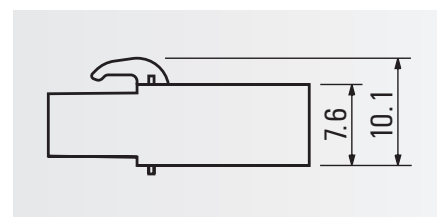

Process-compatible by default – economical processing

Delivery of the crimp contacts loose in bags, or as tape-packaged carrier strips. For the following conductor sizes: 0.22 to 0.35 mm², 0.50 to 1.00 mm², 1.50 to 2.50 mm².

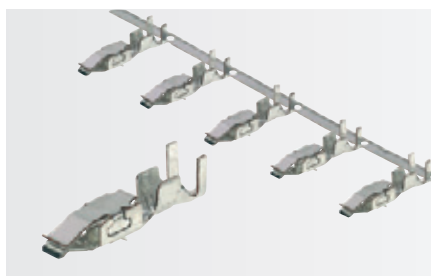

Flexible for a variety of applications

Affordable machine crimping or with hand tools in the field.



High component density

Screw terminals have a 90° angle between the directions of the cable entry and the screw. The required space must then be taken into account when designing the device. In the crimp connector system, however, the conductor insertion and operation is parallel to the circuit board.

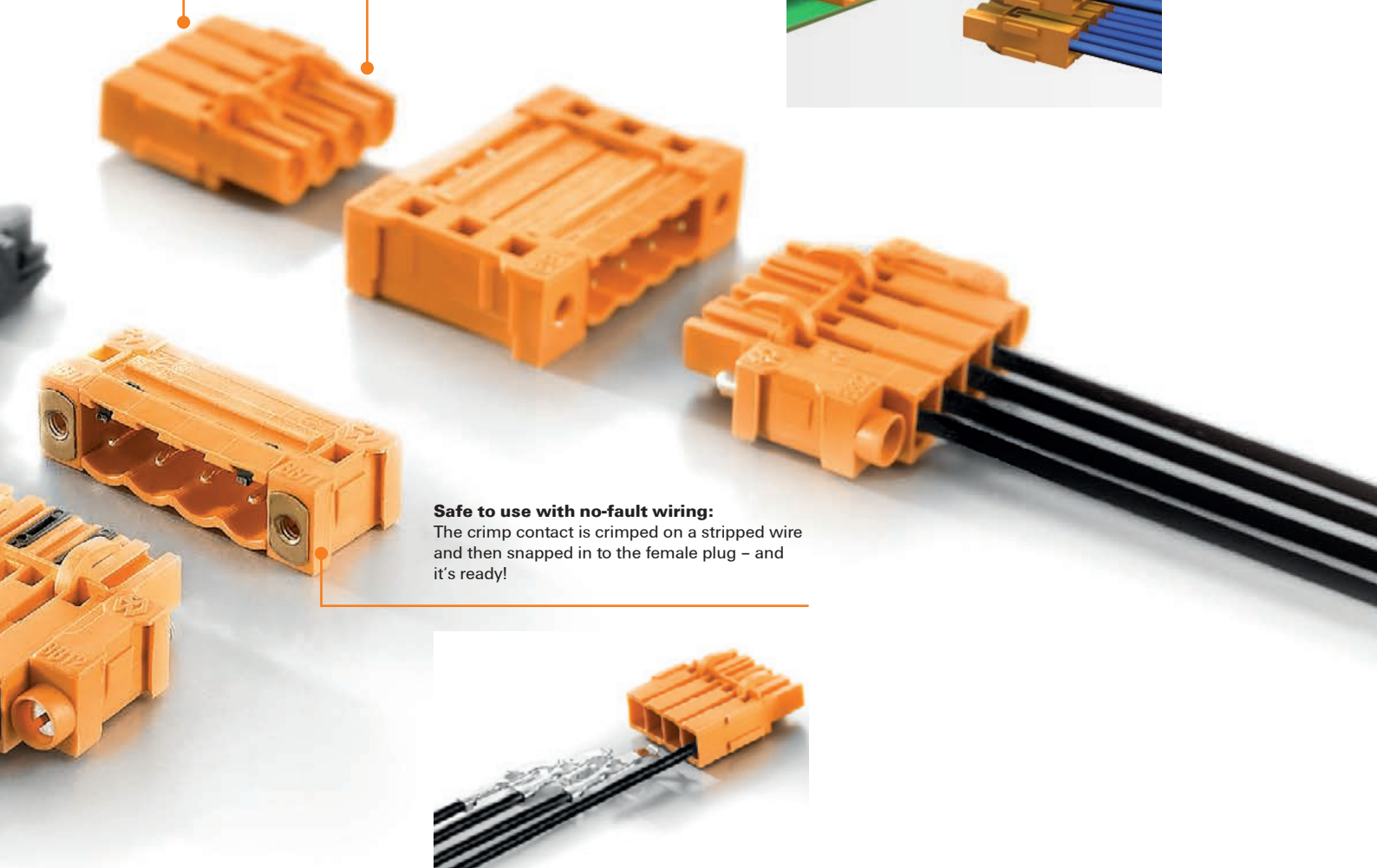
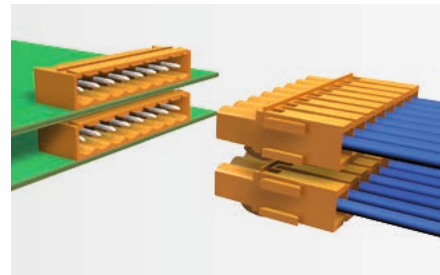



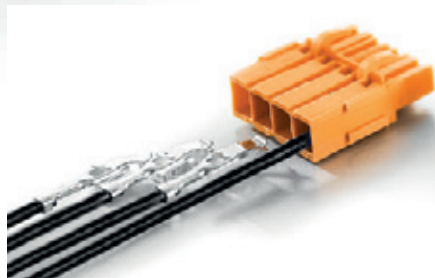

Safe to use with no-fault wiring:

The crimp contact is crimped on a stripped wire and then snapped in to the female plug – and it's ready!



<http://www.OMNIMATE.net>

-  = Wire-to-Board
-  = Board-to-Board
-  = Wire-to-Wire
-  = Board-to-Wire

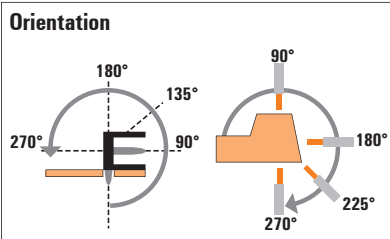

Male header

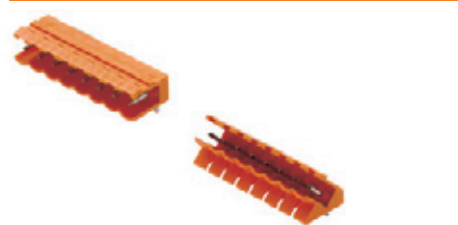
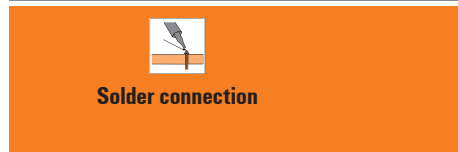















C

BL/SL 5.00 series



Type	Levels	
	1	
	SL	SL
	Orientation	90°
Flange options	(O)/B	(O)/B
IEC / UL	IEC: 400 V/18 A UL: 300 V/15 A	IEC: 400 V/17 A UL: 300 V/15 A
Page	C.144	C.148

Female plug	Screw: Clamping yoke	Image	Type	Orientation	Flange options	IEC / UL	Page	Levels	
								SL	SL
			BLZP	180°	(G)/F/LR	IEC: 400 V/19 A/0.2 - 4 mm ² UL: 300 V/10 A/AWG 26 - 12	C.152		
			BLZP	90°	(G)/F/LR	IEC: 400 V/15.5 A/0.2 - 4 mm ² UL: 300 V/10 A/AWG 26 - 12	C.154		
			BLZP	270°	(G)/F/LR	IEC: 400 V/15.5 A/0.2 - 4 mm ² UL: 300 V/10 A/AWG 26 - 12	C.156		
	Spring: PUSH IN		BLF	180°	(G)/F/LR	IEC: 400 V/20.5 A/0.2 - 2.5 mm ² UL: 300 V/10 A/AWG 26 - 12	C.158		
			BLF	90°	(G)/F/LR	IEC: 400 V/20 A/ 0.2 - 2.5 mm ² UL: 300 V/10 A/ AWG 26 - 12	C.160		

Female plug and header:
(G)* = Closed (without flange)
F = Flange with screw
LR = Lock & Release lever

* not included in the article description

Male header and plug:
(O)* = open
B = Dovetail for fixing blocks with a nut
G = closed
F = Screw flange with nut
LF = Solder flange with nut
GLF = closed with additional solder flange
FLF = Flange with nut and additional solder flange

Male header



Solder connection



Reflow solder connection



	1		2		1		1		2
	SL	SLD	SLD	SL-SMT	SL-SMT	SL-SMaT	SL-SMaT	SLDV-THR	
	180°	90°	180°	90°	180°	90°	180°	180°	
	(0)/B	G	G	(0)/G/LF	(0)/G/LF	(0)	(0)	G/GLF/F/FLF	
	IEC: 400 V/18 A UL: 300 V/15 A	IEC: 400 V/11 A UL: 300 V/10 A	IEC: 400 V/11 A UL: 300 V/10 A	IEC: 400 V/19 A UL: 300 V/15 A	IEC: 400 V/19 A UL: 300 V/15 A	IEC: 400 V/16.5 A UL: 300 V/15 A	IEC: 400 V/16.5 A UL: 300 V/15 A	IEC: 400 V/15 A UL: 300 V/10 A	
	C.146	C.150	C.151	C.134	C.138	C.184	C.185	C.142	
	○	○	○	○	○	○	○	○	
	○			○	○	○	○	○	
	○			○	○	○	○		
	○	○	○	○	○	○	○	○	
	○			○	○	○	○	○	

C

SL-SMT 5.00/./90

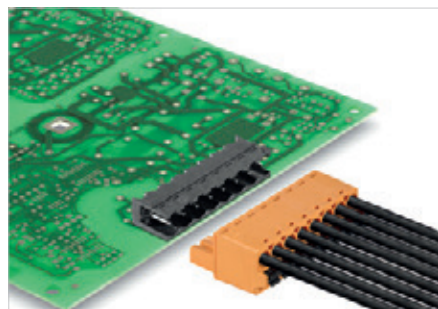

High-temperature-resistant, 90°-angled male header, optimised for SMT processing. The male headers can be manually coded or ordered as pre-coded headers.

- Available in open, closed (G) or with solder Flange (LF).
- The solder flange makes an additional screw-fixation to the PCB unnecessary and protects the solder joints against mechanical stress.
- Available with 1.5 mm or 3.2 mm solder pins.
- Packed either in box (BX) or an anti-static roll (tape-on-reel, RL)
- The 1.5 mm solder pin reduces the solder paste to a minimum without losing holding force to the PCB.

Product data

IEC: 400 V / 19 A
UL: 300 V / 15 A

For additional articles and information, refer to catalog.weidmueller.com

Note:

- Gold-plated contact surfaces on request
- Rated current related to rated cross-section & min. No. of poles.
- Diameter of solder eyelet $D = 1.4 \pm 0.1$ mm
- Diameter of solder eyelet $D = 1.5 \pm 0.1$ mm from 9-pole
- P on drawing = pitch
- Rated data refer only to the component itself. Clearance and creepage distances to other components are to be designed in accordance with the relevant application standards.

SL-SMT 5.00/./90 Box

Packaged in box



Dimensioned drawing

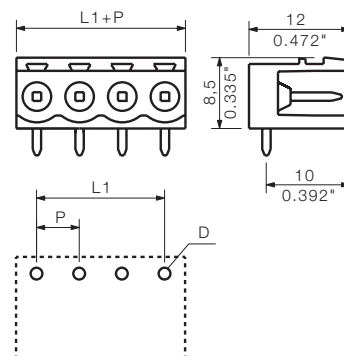

Technical data

In compliance with IEC 60664-1 / IEC 61984			
Clamping range, max.	mm ²		
Solid core H05(07) V-U	mm ²		
Stranded H07 V-R			
Flexible H05(07) V-K	mm ²		
Flexible with ferrule	mm ²		
Ferrule with plastic collar	mm ²		
Stripping length	mm		
Screwdriver blade	mm		
According to norm			
Tightening torque range	Nm		
Rated current, max.	A	19	16
At ambient temperature		20°C	40°C
For conductor cross-section	mm ²		
Overvoltage category		III	III II
Pollution severity		3	2 2
Rated voltage	V	250	320 400
Rated impulse voltage	kV	4	4 4
UL / CUL (Use Group)		B	C D
Rated voltage	V	300	300
Rated current	A	15	10
AWG conductor	AWG		
CSA (Use Group)		B	C D
Rated voltage	V	300	300
Rated current	A	15	10
AWG conductor	AWG		
General data			
Type of insulation material		LCP GF	
UL 94 flammability rating		V-0	
Contact base material		CuSn	
Material of contact surface			
Pin dimensions = d	mm	1.2, Octagonal	
Solder eyelet Ø = D	mm	1.5	
Solder eyelet Ø tolerance	mm	+ 0,1	

Accessories

Note: Refer to the Accessories chapter for additional accessories.		
Coding		Order No.
	BLZ/SL KO OR	1573010000
	BLZ/SL KO SW	1545710000
Partition element		
	SL AT OR	1598300000
	SL AT SW	1770240000
LED light guide		
	SL FLA 1.5/1	1580100000
	SL FLA 1.5/24	1595850000
	SL FLA 2,3/1	1636670000
	SL FLA 2,3/24	1636680000
	SL FLA 3.8/1	1580110000
	SL FLA 3.8/24	1595860000
	SL FLA 9.0/1	1580120000
SL FLA 9.0/24	1595870000	

Ordering data

Solder pin length		1.5 mm	3.2 mm
Colour		Black	Black
Pitch 5.00 mm			
Pol.	L1	(inch)	Qty. Order No. Order No.
2	5.00	0.197	100 1796930000 1839890000
3	10.00	0.394	100 1796940000 1839900000
4	15.00	0.591	100 1796950000 1839910000
5	20.00	0.787	50 1796960000 1839920000
6	25.00	0.984	50 1796970000 1839930000
7	30.00	1.181	50 1796980000 1839940000
8	35.00	1.378	50 1796990000 1839950000
9	40.00	1.575	50 1797000000 1839960000
10	45.00	1.772	50 1797010000 1839970000
11	50.00	1.969	50 1797020000 1839980000
12	55.00	2.165	50 1797030000 1839990000
13	60.00	2.362	50 1797040000 1840000000
14	65.00	2.559	50 1797050000 1840010000
15	70.00	2.756	50 1797060000 1840020000
16	75.00	2.953	50 1797070000 1840030000
17	80.00	3.150	20 1840040000
18	85.00	3.346	20 1840050000
19	90.00	3.543	20 1840060000
20	95.00	3.740	20 1840070000
21	100.00	3.937	20 1840080000
22	105.00	4.134	20 1840090000
23	110.00	4.331	20 1840100000
24	115.00	4.528	20 1840110000

SL-SMT 5.00/./90 Tape

Tape-on-reel



Dimensioned drawing

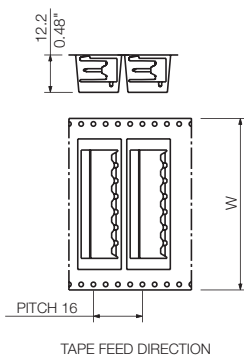

Ordering data

Solder pin length		1.5 mm		
Colour		Black		
Pitch		5.00 mm		
Pol.	L1	(inch)	Qty.	Order No.
2	5.00	0.197	350	1797620000
3	10.00	0.394	350	1797630000
4	15.00	0.591	350	1797640000
5	20.00	0.787	350	1797650000
6	25.00	0.984	350	1797660000
7	30.00	1.181	350	1797670000
8	35.00	1.378	350	1797680000

Tape widths: 32, 44, 56, 72, 88

SL-SMT 5.00/./90G Box

Packaged in box



Dimensioned drawing

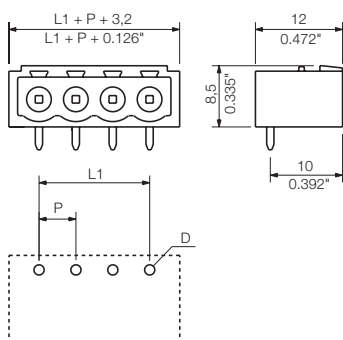

Ordering data

Solder pin length		1.5 mm		3.2 mm	
Colour		Black		Black	
Pitch		5.00 mm			
Pol.	L1	(inch)	Qty.	Order No.	Order No.
2	5.00	0.197	100	1797080000	1840120000
3	10.00	0.394	100	1797090000	1840130000
4	15.00	0.591	100	1797100000	1840140000
5	20.00	0.787	50	1797110000	1840150000
6	25.00	0.984	50	1797120000	1840160000
7	30.00	1.181	50	1797130000	1840170000
8	35.00	1.378	50	1797140000	1840180000
9	40.00	1.575	50	1797150000	1840190000
10	45.00	1.772	50	1797160000	1840200000
11	50.00	1.969	50	1797170000	1840210000
12	55.00	2.165	50	1797180000	1840220000
13	60.00	2.362	50	1797190000	1840230000
14	65.00	2.559	50	1797200000	1840240000
15	70.00	2.756	50	1797210000	1840250000
16	75.00	2.953	50	1797220000	1840260000
17	80.00	3.150	20		1840270000
18	85.00	3.346	20		1840280000
19	90.00	3.543	20		1840290000
20	95.00	3.740	20		1840300000
21	100.00	3.937	20		1840310000
22	105.00	4.134	20		1840320000
23	110.00	4.331	20		1840330000
24	115.00	4.528	20		1840340000

SL-SMT 5.00/./90G Tape

Tape-on-reel



Dimensioned drawing

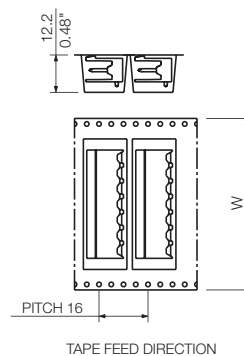

Ordering data

Solder pin length		1.5 mm		
Colour		Black		
Pitch		5.00 mm		
Pol.	L1	(inch)	Qty.	Order No.
2	5.00	0.197	350	1797690000
3	10.00	0.394	350	1797700000
4	15.00	0.591	350	1797710000
5	20.00	0.787	350	1797720000
6	25.00	0.984	350	1797730000
7	30.00	1.181	350	1797740000

Tape widths: 32, 44, 56, 72, 88

SL-SMT 5.00../90

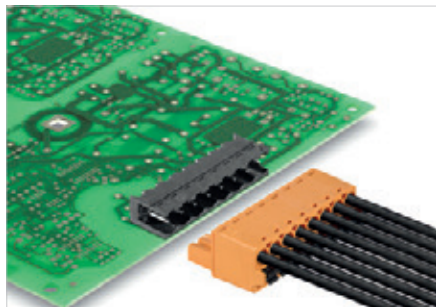

High-temperature-resistant, 90°-angled male header, optimised for SMT processing. The male headers can be manually coded or ordered as pre-coded headers.

- Available in open, closed (G) or with solder Flange (LF).
- The solder flange makes an additional screw-fixation to the PCB unnecessary and protects the solder joints against mechanical stress.
- Available with 1.5 mm or 3.2 mm solder pins.
- Packed either in box (BX) or an anti-static roll (tape-on-reel, RL)
- The 1.5 mm solder pin reduces the solder paste to a minimum without losing holding force to the PCB.

Technical data

In compliance with IEC 60664-1 / IEC 61984			
Clamping range, max.	mm ²		
Solid core H05(07) V-U	mm ²		
Stranded H07 V-R			
Flexible H05(07) V-K	mm ²		
Flexible with ferrule	mm ²		
Ferrule with plastic collar	mm ²		
Stripping length	mm		
Screwdriver blade	mm		
According to norm			
Tightening torque range	Nm		
Rated current, max.	A	19	16
At ambient temperature		20°C	40°C
For conductor cross-section	mm ²		
Overvoltage category		III	III II
Pollution severity		3	2 2
Rated voltage	V	250	320 400
Rated impulse voltage	kV	4	4 4
UL / CUL (Use Group)		B	C D
Rated voltage	V	300	300
Rated current	A	15	10
AWG conductor	AWG		
CSA (Use Group)		B	C D
Rated voltage	V	300	300
Rated current	A	15	10
AWG conductor	AWG		
General data			
Type of insulation material		LCP GF	
UL 94 flammability rating		V-0	
Contact base material		CuSn	
Material of contact surface			
Pin dimensions = d	mm	1.2, Octagonal	
Solder eyelet Ø = D	mm	1.5	
Solder eyelet Ø tolerance	mm	+ 0,1	

Product data

IEC: 400 V / 19 A
UL: 300 V / 15 A

For additional articles and information, refer to catalog.weidmuller.com

- Note:**
- Gold-plated contact surfaces on request
 - Rated current related to rated cross-section & min. No. of poles.
 - P on drawing = pitch
 - Rated data refer only to the component itself. Clearance and creepage distances to other components are to be designed in accordance with the relevant application standards.

SL-SMT 5.00../90LF Box

Packaged in box; with solder flange



Dimensioned drawing

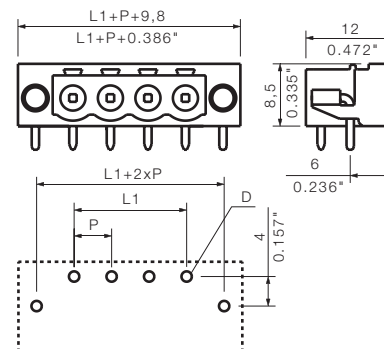

Accessories

Note: Refer to the Accessories chapter for additional accessories.		
Coding		Order No.
	BLZ/SL KO OR	1573010000
	BLZ/SL KO SW	1545710000
Partition element		
	SL AT OR	1598300000
	SL AT SW	1770240000
LED light guide		
	SL FLA 1.5/1	1580100000
	SL FLA 1.5/24	1595850000
	SL FLA 2,3/1	1636670000
	SL FLA 2,3/24	1636680000
	SL FLA 3.8/1	1580110000
	SL FLA 3.8/24	1595860000
	SL FLA 9.0/1	1580120000
SL FLA 9.0/24	1595870000	

Ordering data

Solder pin length		1.5 mm	3.2 mm
Colour		Black	Black
Pitch 5.00 mm			
Pol.	L1 (inch)	Qty.	Order No.
2	5.00	0.197 100	1797230000 1840350000
3	10.00	0.394 100	1797240000 1840360000
4	15.00	0.591 100	1797250000 1840370000
5	20.00	0.787 50	1797260000 1840380000
6	40.00	1.575 50	1797270000 1840390000
7	30.00	1.181 50	1797280000 1840400000
8	35.00	1.378 50	1797290000 1840410000
9	40.00	1.575 50	1797300000 1840420000
10	45.00	1.772 50	1797310000 1840430000
11	50.00	1.969 50	1797320000 1840440000
12	55.00	2.165 50	1797330000 1840450000
13	60.00	2.362 50	1797340000 1840460000
14	65.00	2.559 50	1797350000 1840470000
15	70.00	2.756 50	1797360000 1840480000
16	75.00	2.953 50	1797370000 1840490000
17	80.00	3.150 20	1840500000
18	85.00	3.346 20	1840510000
19	95.00	3.543 20	1840520000
20	100.00	3.740 20	1840530000
21	90.00	3.397 20	1840540000
22	105.00	4.134 20	1840550000
23	115.00	4.331 20	1840560000
24	110.00	4.258 20	1840570000

SL-SMT 5.00/./90LF Tape

Tape-on-reel; with solder flange



Dimensioned drawing

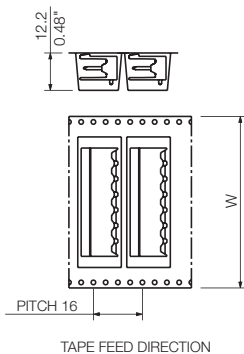

Solder flange (LF)

Normally you use a pin header with fastening flanges (F) in combination with a screw from the rear side of the PCB to increase the fixation forces of the pin headers. The disadvantages are additional process steps that make the PCB mounting complex and cost intensive. The patented solder flange was designed to solve exactly this problem and find a simple and cheap solution. The additional solder pins substitute the present screw flanges and they get soldered together with the pin header. This terminates additional process steps and thus reduces production costs. The additional fixation protects the soldered connections from tensile strain and avoids permanent mechanical stress such as caused by the post-fastened screw forces.

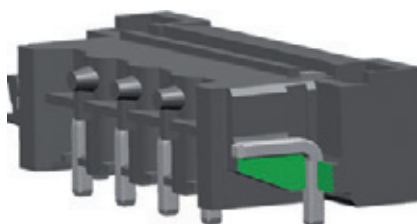

Ordering data

Solder pin length		1.5 mm		
Colour		Black		
Pitch		5.00 mm		
Pol.	L1	(inch)	Qty.	Order No.
2	5.00	0.197	350	1797750000
3	10.00	0.394	350	1797760000
4	15.00	0.591	350	1797770000
5	20.00	0.787	350	1797780000
6	25.00	0.984	350	1797790000

Tape widths: 32, 44, 56, 72, 88

SL-SMT 5.00/./180

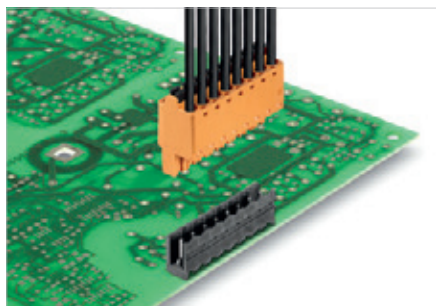

High-temperature-resistant, 180°-angled male header, optimised for SMT processing. The male headers can be manually coded or ordered as pre-coded headers.

- Available in open, closed (G) or with solder Flange (LF).
- The solder flange makes an additional screw-fixation to the PCB unnecessary and protects the solder joints against mechanical stress.
- Available with 1.5 mm or 3.2 mm solder pins.
- Packed either in box (BX) or an anti-static roll (tape-on-reel, RL)
- The 1.5 mm solder pin reduces the solder paste to a minimum without losing holding force to the PCB.

Product data

IEC: 400 V / 19 A
UL: 300 V / 15 A

For additional articles and information, refer to catalog.weidmueller.com

Note:

- Gold-plated contact surfaces on request
- Rated current related to rated cross-section & min. No. of poles.
- Diameter of solder eyelet $D = 1.4 \pm 0.1$ mm
- Diameter of solder eyelet $D = 1.5 \pm 0.1$ mm from 9-pole
- P on drawing = pitch
- Rated data refer only to the component itself. Clearance and creepage distances to other components are to be designed in accordance with the relevant application standards.

SL-SMT 5.00/./180 Box

Packaged in box



Dimensioned drawing

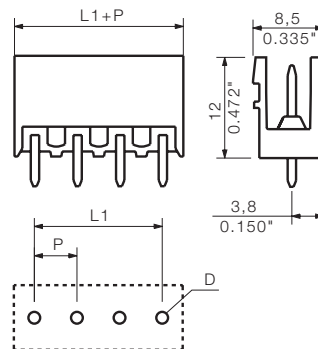

Technical data

In compliance with IEC 60664-1 / IEC 61984			
Clamping range, max.	mm ²		
Solid core H05(07) V-U	mm²		
Stranded H07 V-R			
Flexible H05(07) V-K	mm ²		
Flexible with ferrule	mm ²		
Ferrule with plastic collar	mm ²		
Stripping length	mm		
Screwdriver blade	mm		
According to norm			
Tightening torque range	Nm		
Rated current, max.	A	19	16
At ambient temperature		20°C	40°C
For conductor cross-section	mm ²		
Overvoltage category		III	III II
Pollution severity		3	2 2
Rated voltage	V	250	320 400
Rated impulse voltage	kV	4	4 4
UL / CUL (Use Group)		B	C D
Rated voltage	V	300	300
Rated current	A	15	10
AWG conductor	AWG		
CSA (Use Group)		B	C D
Rated voltage	V	300	300
Rated current	A	15	10
AWG conductor	AWG		
General data			
Type of insulation material		LCP GF	
UL 94 flammability rating		V-0	
Contact base material		CuSn	
Material of contact surface			
Pin dimensions = d	mm	1.2, Octagonal	
Solder eyelet Ø = D	mm	1.5	
Solder eyelet Ø tolerance	mm	+ 0,1	

Accessories

Note: Refer to the Accessories chapter for additional accessories.

Coding		Order No.
	BLZ/SL KO OR	1573010000
	BLZ/SL KO SW	1545710000
Partition element		
	SL AT OR	1598300000
	SL AT SW	1770240000

Ordering data

Solder pin length		1.5 mm	3.2 mm
Colour		Black	Black
Pitch 5.00 mm			
Pol.	L1 (inch)	Qty.	Order No.
2	5.00	0.197	100 1796480000 1840920000
3	10.00	0.394	100 1796490000 1840930000
4	15.00	0.591	100 1796500000 1840940000
5	20.00	0.787	50 1796510000 1840950000
6	25.00	0.984	50 1796520000 1840960000
7	30.00	1.181	50 1796530000 1840970000
8	35.00	1.378	50 1796540000 1840980000
9	40.00	1.575	50 1796550000 1840990000
10	45.00	1.772	50 1796560000 1841000000
11	50.00	1.969	50 1796570000 1841020000
12	55.00	2.165	50 1796580000 1841030000
13	60.00	2.362	50 1796590000 1841040000
14	65.00	2.559	50 1796600000 1841050000
15	70.00	2.756	50 1796610000 1841060000
16	75.00	2.953	50 1796620000 1841070000
17	80.00	3.150	20 1841080000
18	85.00	3.346	20 1841090000
19	90.00	3.543	20 1841100000
20	95.00	3.740	20 1841110000
21	100.00	3.937	20 1841120000
22	105.00	4.134	20 1841130000
23	110.00	4.331	20 1841140000
24	115.00	4.528	20 1841150000

SL-SMT 5.00/./180 Tape

Tape-on-reel



Dimensioned drawing

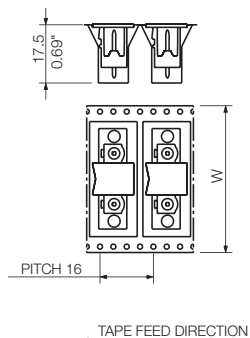

Ordering data

Solder pin length		1.5 mm		
Colour		Black		
Pitch		5.00 mm		
Pol.	L1	(inch)	Qty.	Order No.
2	5.00	0.197	250	1797800000
3	10.00	0.394	250	1797810000
4	15.00	0.591	250	1797820000
5	20.00	0.787	250	1797830000
6	25.00	0.984	250	1797840000
7	30.00	1.181	250	1797850000
8	35.00	1.378	250	1797860000

Tape widths: 32, 44, 56, 72, 88

SL-SMT 5.00/./180G Box

Packaged in box



Dimensioned drawing

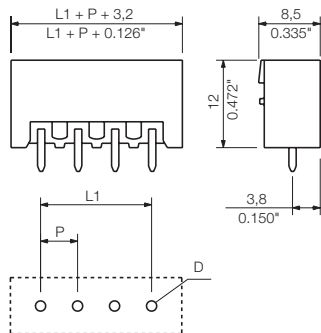

Ordering data

Solder pin length		1.5 mm		3.2 mm	
Colour		Black		Black	
Pitch		5.00 mm			
Pol.	L1	(inch)	Qty.	Order No.	Order No.
2	5.00	0.197	100	1796630000	1841160000
3	10.00	0.394	100	1796640000	1841170000
4	15.00	0.591	100	1796650000	1841180000
5	20.00	0.787	50	1796660000	1841190000
6	25.00	0.984	50	1796670000	1841200000
7	30.00	1.181	50	1796680000	1841210000
8	35.00	1.378	50	1796690000	1841220000
9	40.00	1.575	50	1796700000	1841230000
10	45.00	1.772	50	1796710000	1841240000
11	50.00	1.969	50	1796720000	1841250000
12	55.00	2.165	50	1796730000	1841260000
13	60.00	2.362	50	1796740000	1841270000
14	65.00	2.559	50	1796750000	1841280000
15	70.00	2.756	50	1796760000	1841290000
16	75.00	2.953	50	1796770000	1841300000
17	80.00	3.150	20		1841310000
18	85.00	3.346	20		1841320000
19	90.00	3.543	20		1841330000
20	95.00	3.740	20		1841340000
21	100.00	3.937	20		1841350000
22	105.00	4.134	20		1841360000
23	110.00	4.331	20		1841370000
24	115.00	4.528	20		1841380000

SL-SMT 5.00/./180G Tape

Tape-on-reel



Dimensioned drawing

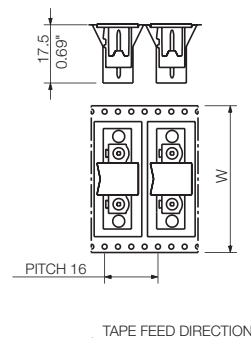

Ordering data

Solder pin length		1.5 mm		
Colour		Black		
Pitch		5.00 mm		
Pol.	L1	(inch)	Qty.	Order No.
2	5.00	0.197	250	1797870000
3	10.00	0.394	250	1797880000
4	15.00	0.591	250	1797890000
5	20.00	0.787	250	1797900000
6	25.00	0.984	250	1797910000
7	30.00	1.181	250	1797920000

Tape widths: 32, 44, 56, 72, 88

SL-SMT 5.00/./180

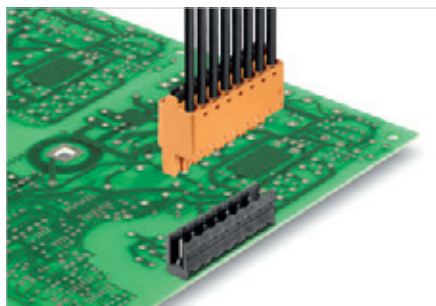

High-temperature-resistant, 180°-angled male header, optimised for SMT processing. The male headers can be manually coded or ordered as pre-coded headers.

- Available in open, closed (G) or with solder Flange (LF).
- The solder flange makes an additional screw-fixation to the PCB unnecessary and protects the solder joints against mechanical stress.
- Available with 1.5 mm or 3.2 mm solder pins.
- Packed either in box (BX) or an anti-static roll (tape-on-reel, RL)
- The 1.5 mm solder pin reduces the solder paste to a minimum without losing holding force to the PCB.

Technical data

In compliance with IEC 60664-1 / IEC 61984			
Clamping range, max.	mm ²		
Solid core H05(07) V-U	mm ²		
Stranded H07 V-R			
Flexible H05(07) V-K	mm ²		
Flexible with ferrule	mm ²		
Ferrule with plastic collar	mm ²		
Stripping length	mm		
Screwdriver blade	mm		
According to norm			
Tightening torque range	Nm		
Rated current, max.	A	19	16
At ambient temperature		20°C	40°C
For conductor cross-section	mm ²		
Overvoltage category		III	III II
Pollution severity		3	2 2
Rated voltage	V	250	320 400
Rated impulse voltage	kV	4	4 4
UL / CUL (Use Group)		B	C D
Rated voltage	V	300	300
Rated current	A	15	10
AWG conductor	AWG		
CSA (Use Group)		B	C D
Rated voltage	V	300	300
Rated current	A	15	10
AWG conductor	AWG		
General data			
Type of insulation material		LCP GF	
UL 94 flammability rating		V-0	
Contact base material		CuSn	
Material of contact surface			
Pin dimensions = d	mm	1.2, Octagonal	
Solder eyelet Ø = D	mm	1.5	
Solder eyelet Ø tolerance	mm	+ 0,1	

Product data

IEC: 400 V / 19 A
UL: 300 V / 15 A

For additional articles and information, refer to catalog.weidmueller.com

Note:

- Gold-plated contact surfaces on request
- Rated current related to rated cross-section & min. No. of poles.
- P on drawing = pitch
- Rated data refer only to the component itself. Clearance and creepage distances to other components are to be designed in accordance with the relevant application standards.

SL-SMT 5.00/./180LF Box

Packaged in box; with solder flange



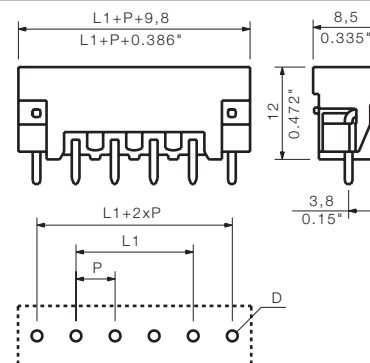

Dimensioned drawing



Accessories

Note: Refer to the Accessories chapter for additional accessories.

Coding		Order No.
	BLZ/SL KO OR	1573010000
	BLZ/SL KO SW	1545710000
Partition element		
	SL AT OR	1598300000
	SL AT SW	1770240000

Ordering data

Solder pin length		1.5 mm	3.2 mm		
Colour		Black	Black		
Pitch 5.00 mm					
Pol.	L1	(inch)	Qty.	Order No.	Order No.
2	5.00	0.197	100	1796780000	1841390000
3	10.00	0.394	100	1796790000	1841400000
4	15.00	0.591	100	1796800000	1841410000
5	20.00	0.787	50	1796810000	1841420000
6	25.00	0.984	50	1796820000	1841430000
7	30.00	1.181	50	1796830000	1841440000
8	35.00	1.378	50	1796840000	1841450000
9	40.00	1.575	50	1796850000	1841460000
10	45.00	1.772	50	1796860000	1841470000
11	50.00	1.969	50	1796870000	1841480000
12	55.00	2.165	50	1796880000	1841490000
13	60.00	2.362	50	1796890000	1841500000
14	65.00	2.559	50	1796900000	1841510000
15	70.00	2.756	50	1796910000	1841520000
16	75.00	2.953	50	1796920000	1841530000
17	5.00	0.197	20		1841540000
18	5.00	0.197	20		1841550000
19	5.00	0.197	20		1841560000
20	5.00	0.197	20		1841570000
21	5.00	0.197	20		1841580000
22	5.00	0.197	20		1841590000
23	5.00	0.197	20		1841600000
24	5.00	0.197	20		1841610000

SL-SMT 5.00/./180LF Tape

Tape-on-reel; with solder flange



Dimensioned drawing

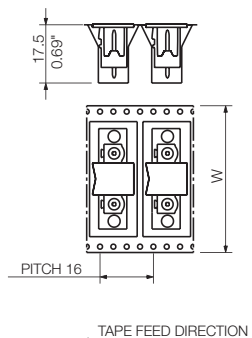

Solder flange (LF)

Normally you use a pin header with fastening flanges (F) in combination with a screw from the rear side of the PCB to increase the fixation forces of the pin headers. The disadvantages are additional process steps that make the PCB mounting complex and cost intensive. The patented solder flange was designed to solve exactly this problem and find a simple and cheap solution. The additional solder pins substitute the present screw flanges and they get soldered together with the pin header. This terminates additional process steps and thus reduces production costs. The additional fixation protects the soldered connections from tensile strain and avoids permanent mechanical stress such as caused by the post-fastened screw forces.

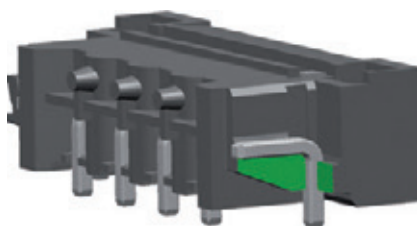

Ordering data

Solder pin length		1.5 mm		
Colour		Black		
Pitch		5.00 mm		
Pol.	L1	(inch)	Qty.	Order No.
2	5.00	0.197	250	1797930000
3	10.00	0.394	250	1797940000
4	15.00	0.591	250	1797950000
5	20.00	0.787	250	1797960000
6	25.00	0.984	250	1797970000

Tape widths: 32, 44, 56, 72, 88

SLDV-THR 5.00/./180

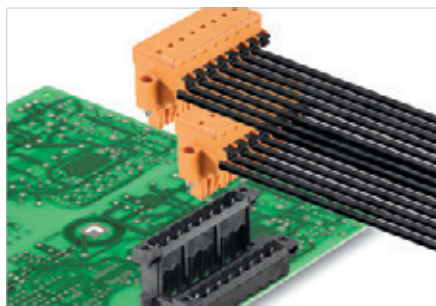

Double-level, 180° male header, optimised for the SMT process. The connection levels are offset and designed for a female plug with screw connection or PUSH IN wire connect. The male headers can be manually coded or ordered as pre-coded headers.

- Available in closed (G), with solder Flange (GLF), screw flange (F) or screw & solder flange (FLF).
- The solder flange makes an additional screw-fixation to the PCB unnecessary and protects the solder joints against mechanical stress.
- Available with 1.5 mm or 3.2 mm solder pins.
- The 1.5 mm solder pin reduces the solder paste to a minimum without losing holding force to the PCB.
- The FLF version is featured with a soldering flange and an additional screw-fastening possibility to the PCB.

Technical data

In compliance with IEC 60664-1 / IEC 61984			
Clamping range, max.	mm ²		
Solid core H05(07) V-U	mm²		
Stranded H07 V-R			
Flexible H05(07) V-K	mm ²		
Flexible with ferrule	mm ²		
Ferrule with plastic collar	mm ²		
Stripping length	mm		
Screwdriver blade	mm		
According to norm			
Tightening torque range	Nm		
Rated current, max.	A	15	13
At ambient temperature		20°C	40°C
For conductor cross-section	mm ²		
Overtolerance category		III	III II
Pollution severity		3	2 2
Rated voltage	V	250	320 400
Rated impulse voltage	kV	4	4 4
UL / CUL (Use Group)		B	C D
Rated voltage	V	300	300
Rated current	A	10	10
AWG conductor	AWG		-
CSA (Use Group)		B	C D
Rated voltage	V	300	300
Rated current	A	10	10
AWG conductor	AWG		-
General data			
Type of insulation material		LCP GF	
UL 94 flammability rating		V-0	
Contact base material		CuSn	
Material of contact surface		tinned	
Pin dimensions = d	mm	1.2, Octagonal	
Solder eyelet Ø = D	mm	1.5	
Solder eyelet Ø tolerance	mm	+ 0,1	

Product data

IEC: 400 V / 15 A
UL: 300 V / 10 A

For additional articles and information, refer to catalog.weidmueller.com

- Note:**
- Rated current related to rated cross-section & min. No. of poles.
 - Spacing between rows: see hole layout
 - P on drawing = pitch
 - Rated data refer only to the component itself. Clearance and creepage distances to other components are to be designed in accordance with the relevant application standards.

SLDV-THR 5.00/./180G

without solder flange



Dimensioned drawing

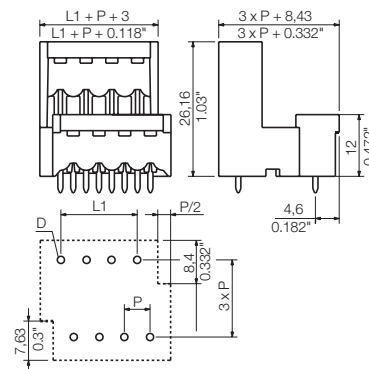



Ordering data

Solder pin length		1.5 mm	3.2 mm
Colour		Black	Black
Pitch 5.00 mm			
Pol.	L1 (inch)	Qty.	Order No.
4	5.00	0.197 50	1894980000 1882690000
6	10.00	0.394 50	1894990000 1882700000
8	15.00	0.591 50	1895000000 1882370000
10	20.00	0.787 50	1895010000 1882710000
12	25.00	0.984 50	1895020000 1882720000
14	30.00	1.181 20	1895030000 1882730000
16	35.00	1.378 20	1895040000 1862380000
18	40.00	1.575 20	1895050000 1882740000
20	45.00	1.772 20	1895060000 1862390000
22	50.00	1.969 10	1895070000 1882750000
24	55.00	2.165 10	1895080000 1882760000
26	60.00	2.362 10	1895090000 1882770000
28	65.00	2.559 10	1895100000 1882780000
30	70.00	2.756 10	1895110000 1882790000
32	75.00	2.953 10	1895120000 1882800000
34	80.00	3.150 10	1895130000 1882810000
36	85.00	3.346 10	1895140000 1882820000
38	90.00	3.543 10	1895150000 1882830000
40	95.00	3.740 10	1895180000 1862400000
42	100.00	3.937 10	1895190000 1882840000
44	105.00	4.134 10	1895200000 1882850000
46	110.00	4.331 10	1895210000 1882860000
48	115.00	4.528 10	1895220000 1882870000

Accessories

Note: Refer to the Accessories chapter for additional accessories.

Coding		Order No.
	BLZ/SL KO OR	1573010000
	BLZ/SL KO SW	1545710000
Partition element		
	SL AT OR	1598300000
	SL AT SW	1770240000

SLDV-THR 5.00../180GLF

with solder flange



Dimensioned drawing

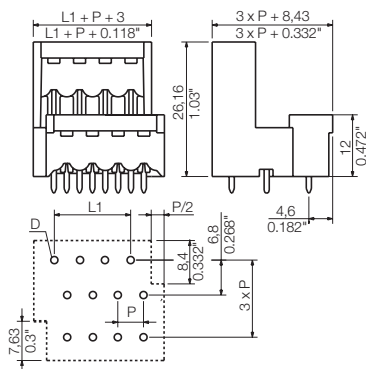

Ordering data

Solder pin length		1.5 mm	3.2 mm		
Colour		Black	Black		
Pitch 5.00 mm					
Pol.	L1 (inch)	Qty.	Order No.	Order No.	
4	5.00	0.197	50	1911750000	1911290000
6	10.00	0.394	50	1911760000	1911310000
8	15.00	0.591	50	1911770000	1911320000
10	20.00	0.787	50	1911780000	1911330000
12	25.00	0.984	50	1911790000	1911340000
14	30.00	1.181	20	1911800000	1911350000
16	35.00	1.378	20	1911810000	1911360000
18	40.00	1.575	20	1911820000	1911370000
20	45.00	1.772	20	1911830000	1911410000
22	50.00	1.969	10	1911840000	1911470000
24	55.00	2.165	10	1911850000	1911500000
26	60.00	2.362	10	1911860000	1911520000
28	65.00	2.559	10	1911870000	1911550000
30	70.00	2.756	10	1911880000	1911640000
32	75.00	2.953	10	1911890000	1911650000
34	80.00	3.150	10	1911900000	1911660000
36	85.00	3.346	10	1911910000	1911670000
38	90.00	3.543	10	1911920000	1911680000
40	95.00	3.740	10	1911930000	1911690000
42	100.00	3.937	10	1911940000	1911710000
44	105.00	4.134	10	1911950000	1911720000
46	110.00	4.331	10	1911960000	1911730000
48	115.00	4.528	10	1911970000	1911740000

SLDV-THR 5.00../180F

without solder flange



Dimensioned drawing

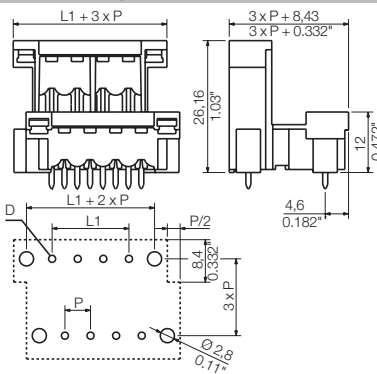

Ordering data

Solder pin length		1.5 mm	3.2 mm		
Colour		Black	Black		
Pitch 5.00 mm					
Pol.	L1 (inch)	Qty.	Order No.	Order No.	
4	5.00	0.197	50	1895230000	1882930000
6	10.00	0.394	50	1895240000	1882940000
8	15.00	0.591	50	1895250000	1882950000
10	20.00	0.787	50	1895260000	1882960000
12	25.00	0.984	50	1895270000	1882970000
14	30.00	1.181	20	1895280000	1882980000
16	35.00	1.378	20	1895290000	1882990000
18	40.00	1.575	20	1895300000	1883000000
20	45.00	1.772	20	1895310000	1881340000
22	50.00	1.969	10	1895320000	1883010000
24	55.00	2.165	10	1895330000	1881370000
26	60.00	2.362	10	1895340000	1883020000
28	65.00	2.559	10	1895350000	1881390000
30	70.00	2.756	10	1895360000	1883030000
32	75.00	2.953	10	1895370000	1881400000
34	80.00	3.150	10	1895380000	1881420000
36	85.00	3.346	10	1895390000	1881470000
38	90.00	3.543	10	1895400000	1883040000
40	95.00	3.740	10	1895410000	1881490000
42	100.00	3.937	10	1895420000	1883050000
44	105.00	4.134	10	1895430000	1883060000
46	110.00	4.331	10	1895440000	1883070000
48	115.00	4.528	10	1895450000	1883080000

SLDV-THR 5.00../180FLF

with solder flange



Dimensioned drawing

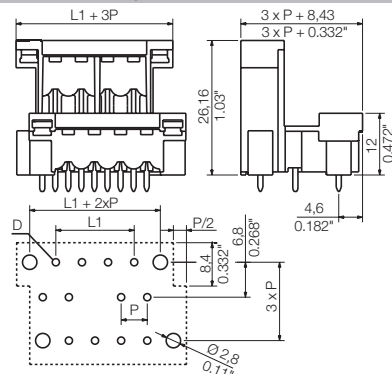

Ordering data

Solder pin length		1.5 mm	3.2 mm		
Colour		Black	Black		
Pitch 5.00 mm					
Pol.	L1 (inch)	Qty.	Order No.	Order No.	
4	5.00	0.197	50	1895460000	1883100000
6	10.00	0.394	50	1895470000	1883110000
8	15.00	0.591	50	1895480000	1883120000
10	20.00	0.787	50	1895490000	1883130000
12	25.00	0.984	50	1895500000	1883140000
14	30.00	1.181	20	1895510000	1883150000
16	35.00	1.378	20	1895520000	1883160000
18	40.00	1.575	20	1895530000	1883170000
20	45.00	1.772	20	1895540000	1883180000
22	50.00	1.969	10	1895550000	1883190000
24	55.00	2.165	10	1895560000	1883200000
26	60.00	2.362	10	1895570000	1883230000
28	65.00	2.559	10	1895580000	1883240000
30	70.00	2.756	10	1895590000	1883250000
32	75.00	2.953	10	1895600000	1883270000
34	80.00	3.150	10	1895610000	1883280000
36	85.00	3.346	10	1895620000	1883290000
38	90.00	3.543	10	1895630000	1883300000
40	95.00	3.740	10	1895640000	1883310000
42	100.00	3.937	10	1895650000	1883320000
44	105.00	4.134	10	1895660000	1883330000
46	110.00	4.331	10	1895670000	1883340000
48	115.00	4.528	10	1895680000	1883350000

SL 5.00/./90

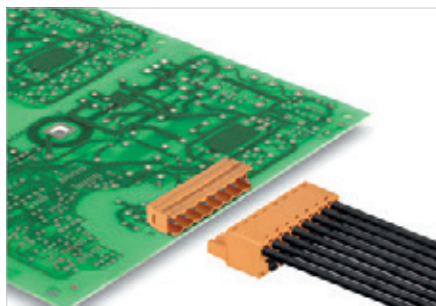

Male headers with 90° orientation, optimised for wave soldering. Available in versions with either open or closed ends (B). Mounting blocks can be attached into the closed variants. The blocks can be used to screw on to the female plug of the circuit board. The male headers can be manually coded or ordered as pre-coded headers.

Product data

IEC: 400 V / 18 A
UL: 300 V / 15 A

For additional articles and information, refer to catalog.weidmuller.com

Note:

- Additional colours on request
- Gold-plated contact surfaces on request
- Rated current related to rated cross-section & min. No. of poles.
- P on drawing = pitch
- Rated data refer only to the component itself. Clearance and creepage distances to other components are to be designed in accordance with the relevant application standards.

SL 5.00/./90

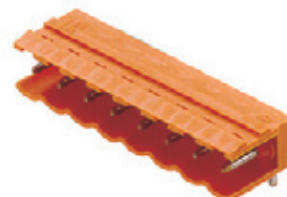

Dimensioned drawing

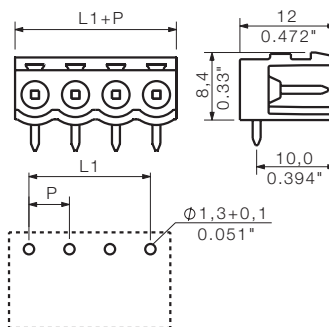

Technical data

In compliance with IEC 60664-1 / IEC 61984			
Clamping range, max.	mm ²		
Solid core H05(07) V-U	mm²		
Stranded H07 V-R			
Flexible H05(07) V-K	mm ²		
Flexible with ferrule	mm ²		
Ferrule with plastic collar	mm ²		
Stripping length	mm		
Screwdriver blade	mm		
According to norm			
Tightening torque range	Nm		
Rated current, max.	A	18	15
At ambient temperature		20°C	40°C
For conductor cross-section	mm ²		
Overvoltage category		III	III II
Pollution severity		3	2 2
Rated voltage	V	250	320 400
Rated impulse voltage	kV	4	4 4
UL / CUL (Use Group)		B	C D
Rated voltage	V	300	300
Rated current	A	15	10
AWG conductor	AWG		
CSA (Use Group)		B	C D
Rated voltage	V	300	300
Rated current	A	15	10
AWG conductor	AWG		
General data			
Type of insulation material		PBT	
UL 94 flammability rating		V-0	
Contact base material		CuSn	
Material of contact surface		tinned	
Pin dimensions = d	mm	1.2, Octagonal	
Solder eyelet Ø = D	mm	1.3	
Solder eyelet Ø tolerance	mm	+ 0,1	

Accessories

Note: Refer to the Accessories chapter for additional accessories.		
Coding		Order No.
	BLZ/SL KO OR	1573010000
	BLZ/SL KO SW	1545710000
Partition element		
	SL AT OR	1598300000
	SL AT SW	1770240000
LED light guide		
	SL FLA 1.5/1	1580100000
	SL FLA 1.5/24	1595850000
	SL FLA 2,3/1	1636670000
	SL FLA 2,3/24	1636680000
	SL FLA 3.8/1	1580110000
	SL FLA 3.8/24	1595860000
	SL FLA 9.0/1	1580120000
	SL FLA 9.0/24	1595870000
Mounting block		
	SLA BB11R OR	1604120000
	SLA BB11R SW	1692340000

Ordering data

Solder pin length		3.2 mm		
Colour		Orange		
Pitch	5.00 mm			
Pol.	L1	(inch)	Qty.	Order No.
2	5.00	0.197	100	1571130000
3	10.00	0.394	100	1571140000
4	15.00	0.591	100	1571150000
5	20.00	0.787	50	1571160000
6	25.00	0.984	50	1571170000
7	30.00	1.181	50	1571180000
8	35.00	1.378	50	1571190000
9	40.00	1.575	50	1571200000
10	45.00	1.772	50	1571210000
11	50.00	1.969	50	1571220000
12	55.00	2.165	50	1571110000
13	60.00	2.362	50	1571230000
14	65.00	2.559	50	1571240000
15	70.00	2.756	50	1571250000
16	75.00	2.953	50	1571260000
17	80.00	3.150	20	1571270000
18	85.00	3.346	20	1571280000
19	90.00	3.543	20	1571290000
20	95.00	3.740	20	1571300000
21	100.00	3.937	20	1571310000
22	105.00	4.134	20	1571320000
23	110.00	4.331	20	1571330000
24	115.00	4.528	20	1571340000

SL 5.00/..90B

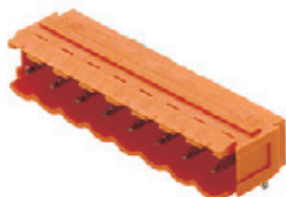

Dimensioned drawing

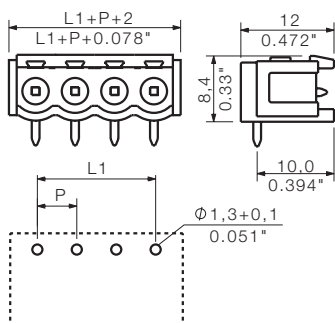

Ordering data

Solder pin length		3.2 mm		
Colour		Orange		
Pitch		5.00 mm		
Pol.	L1	(inch)	Qty.	Order No.
2	5.00	0.197	100	1580860000
3	10.00	0.394	100	1580870000
4	15.00	0.591	100	1580880000
5	20.00	0.787	50	1580890000
6	25.00	0.984	50	1580900000
7	30.00	1.181	50	1580910000
8	35.00	1.378	50	1580920000
9	40.00	1.575	50	1580930000
10	45.00	1.772	50	1580940000
11	50.00	1.969	50	1580950000
12	55.00	2.165	50	1580960000
13	60.00	2.362	50	1580970000
14	65.00	2.559	50	1580980000
15	70.00	2.756	50	1580990000
16	75.00	2.953	50	1581000000
17	80.00	3.150	20	1581010000
18	85.00	3.346	20	1581020000
19	90.00	3.543	20	1581030000
20	95.00	3.740	20	1581040000
21	100.00	3.937	20	1581050000
22	105.00	4.134	20	1581060000
23	110.00	4.331	20	1581070000
24	115.00	4.528	20	1581080000

SL 5.00/./180

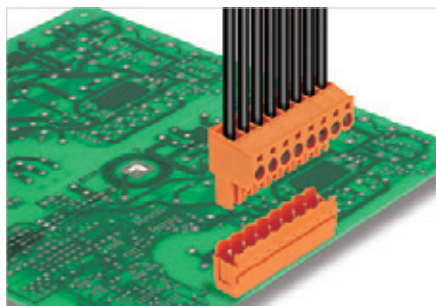

Male headers with 180° wire outlet, optimised for wave soldering. Available in versions with either open or closed ends (B). Mounting blocks can be attached onto the closed variants. The blocks can be used to screw on to the female plug of the circuit board. The male headers can be manually coded or ordered as pre-coded headers.

Product data

IEC: 400 V / 18 A
UL: 300 V / 15 A

For additional articles and information, refer to catalog.weidmueller.com

- Note:**
- Additional colours on request
 - Gold-plated contact surfaces on request
 - Rated current related to rated cross-section & min. No. of poles.
 - P on drawing = pitch
 - Rated data refer only to the component itself. Clearance and creepage distances to other components are to be designed in accordance with the relevant application standards.

SL 5.00/./180

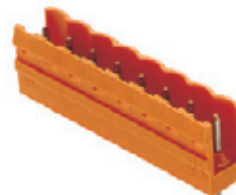

Dimensioned drawing

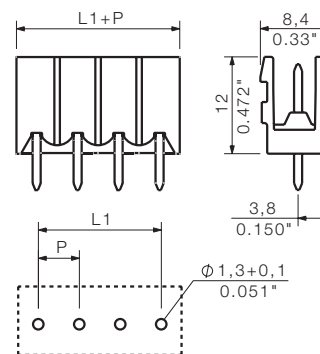

C

Technical data

In compliance with IEC 60664-1 / IEC 61984			
Clamping range, max.	mm ²		
Solid core H05(07) V-U	mm ²		
Stranded H07 V-R			
Flexible H05(07) V-K	mm ²		
Flexible with ferrule	mm ²		
Ferrule with plastic collar	mm ²		
Stripping length	mm		
Screwdriver blade	mm		
According to norm			
Tightening torque range	Nm		
Rated current, max.	A	18	15
At ambient temperature		20°C	40°C
For conductor cross-section	mm ²		
Overvoltage category		III	III II
Pollution severity		3	2 2
Rated voltage	V	250	320 400
Rated impulse voltage	kV	4	4 4
UL / CUL (Use Group)		B	C D
Rated voltage	V	300	300
Rated current	A	15	10
AWG conductor	AWG		
CSA (Use Group)		B	C D
Rated voltage	V	300	300
Rated current	A	15	10
AWG conductor	AWG		
General data			
Type of insulation material		PBT	
UL 94 flammability rating		V-0	
Contact base material		CuSn	
Material of contact surface		tinned	
Pin dimensions = d	mm	1.2, Octagonal	
Solder eyelet Ø = D	mm	1.3	
Solder eyelet Ø tolerance	mm	+ 0,1	

Accessories

Note: Refer to the Accessories chapter for additional accessories.

Coding		Order No.
	BLZ/SL KO OR	1573010000
	BLZ/SL KO SW	1545710000
Partition element		
	SL AT OR	1598300000
	SL AT SW	1770240000
Mounting block		
	SLA BB11R OR	1604120000
	SLA BB11R SW	1692340000

Ordering data

Solder pin length		3.2 mm		
Colour		Orange		
Pitch	5.00 mm			
Pol.	L1	(inch)	Qty.	Order No.
2	5.00	0.197	100	1581320000
3	10.00	0.394	100	1581330000
4	15.00	0.591	100	1581340000
5	20.00	0.787	50	1581350000
6	25.00	0.984	50	1581360000
7	30.00	1.181	50	1581370000
8	35.00	1.378	50	1581380000
9	40.00	1.575	50	1581390000
10	45.00	1.772	50	1581400000
11	50.00	1.969	50	1581410000
12	55.00	2.165	50	1581420000
13	60.00	2.362	50	1581430000
14	65.00	2.559	50	1581440000
15	70.00	2.756	50	1581450000
16	75.00	2.953	50	1581460000
17	80.00	3.150	20	1581470000
18	85.00	3.346	20	1581480000
19	90.00	3.543	20	1581490000
20	95.00	3.740	20	1581500000
21	100.00	3.937	20	1581510000
22	105.00	4.134	20	1581520000
23	110.00	4.331	20	1581530000
24	115.00	4.528	20	1581540000

SL 5.00/.. /180B



Dimensioned drawing

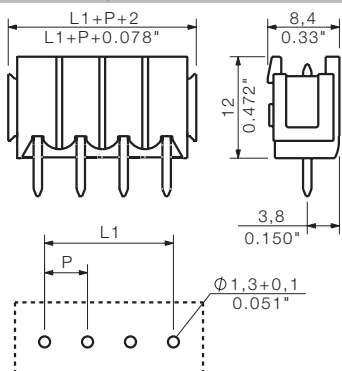

Ordering data

Solder pin length		3.2 mm		
Colour		Orange		
Pitch		5.00 mm		
Pol.	L1	(inch)	Qty.	Order No.
2	5.00	0.197	100	1581780000
3	10.00	0.394	100	1581790000
4	15.00	0.591	100	1581800000
5	20.00	0.787	50	1581810000
6	25.00	0.984	50	1581820000
7	30.00	1.181	50	1581830000
8	35.00	1.378	50	1581840000
9	40.00	1.575	50	1581850000
10	45.00	1.772	50	1581860000
11	50.00	1.969	50	1581870000
12	55.00	2.165	50	1581880000
13	60.00	2.362	50	1581890000
14	65.00	2.559	50	1581900000
15	70.00	2.756	50	1581910000
16	75.00	2.953	50	1581920000
17	80.00	3.150	20	1581930000
18	85.00	3.346	20	1581940000
19	90.00	3.543	20	1581950000
20	95.00	3.740	20	1581960000
21	100.00	3.937	20	1581970000
22	105.00	4.134	20	1581980000
23	110.00	4.331	20	1581990000
24	115.00	4.528	20	1582000000

SL 5.00/./135

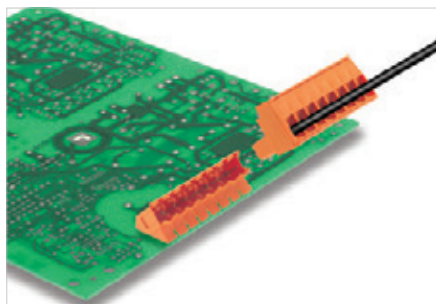

Male headers with 135° wire outlet, optimised for wave soldering. Available in versions with either open or closed ends (B). Mounting blocks can be attached onto the closed variants. The blocks can be used to screw on to the female plug of the circuit board. The male headers can be manually coded or ordered as pre-coded headers.

Technical data

In compliance with IEC 60664-1 / IEC 61984			
Clamping range, max.	mm ²		
Solid core H05(07) V-U	mm²		
Stranded H07 V-R			
Flexible H05(07) V-K	mm ²		
Flexible with ferrule	mm ²		
Ferrule with plastic collar	mm ²		
Stripping length	mm		
Screwdriver blade	mm		
According to norm			
Tightening torque range	Nm		
Rated current, max.	A	17	15
At ambient temperature		20°C	40°C
For conductor cross-section	mm ²		
Overvoltage category		III	III II
Pollution severity		3	2 2
Rated voltage	V	250	320 400
Rated impulse voltage	kV	4	4 4
UL / CUL (Use Group)		B	C D
Rated voltage	V	300	300
Rated current	A	15	10
AWG conductor	AWG		
CSA (Use Group)		B	C D
Rated voltage	V	300	300
Rated current	A	15	10
AWG conductor	AWG		
General data			
Type of insulation material		PBT	
UL 94 flammability rating		V-0	
Contact base material		CuSn	
Material of contact surface		tinned	
Pin dimensions = d	mm	1.2, Octagonal	
Solder eyelet Ø = D	mm	1.3	
Solder eyelet Ø tolerance	mm	+ 0,1	

Product data

IEC: 400 V / 17 A
UL: 300 V / 15 A

For additional articles and information, refer to catalog.weidmueller.com

- Note:**
- Additional colours on request
 - Gold-plated contact surfaces on request
 - Rated current related to rated cross-section & min. No. of poles.
 - P on drawing = pitch
 - Rated data refer only to the component itself. Clearance and creepage distances to other components are to be designed in accordance with the relevant application standards.

SL 5.00/./135



Dimensioned drawing

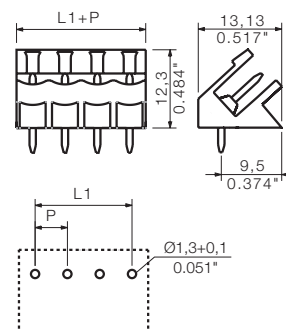

Accessories

Note: Refer to the Accessories chapter for additional accessories.

Coding		Order No.
	BLZ/SL KO OR	1573010000
	BLZ/SL KO SW	1545710000
Partition element		
	SL AT OR	1598300000
	SL AT SW	1770240000
Mounting block		
	SL 135 BB15R OR	1606450000
	SL 135 BB15R SW	1636370000

Ordering data

Solder pin length		3.2 mm		
Colour		Orange		
Pitch	5.00 mm			
Pol.	L1	(inch)	Qty.	Order No.
2	5.00	0.197	100	1630250000
3	10.00	0.394	100	1630260000
4	15.00	0.591	100	1630270000
5	20.00	0.787	50	1630280000
6	25.00	0.984	50	1630290000
7	30.00	1.181	50	1630300000
8	35.00	1.378	50	1630310000
9	40.00	1.575	50	1630320000
10	45.00	1.772	50	1630330000
11	50.00	1.969	50	1630340000
12	55.00	2.165	50	1630350000
13	60.00	2.362	50	1630360000
14	65.00	2.559	50	1630370000
15	70.00	2.756	50	1630380000
16	75.00	2.953	50	1630390000
17	80.00	3.150	20	1630400000
18	85.00	3.346	20	1630410000
19	90.00	3.543	20	1630420000
20	95.00	3.740	20	1630430000
21	100.00	3.937	20	1630440000
22	105.00	4.134	20	1630450000
23	110.00	4.331	20	1630460000
24	115.00	4.528	20	1630470000

SL 5.00/..../135B



Dimensioned drawing

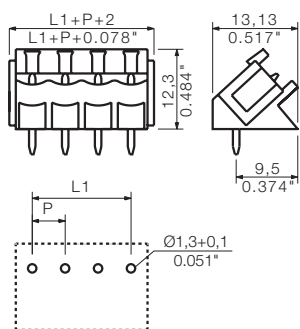

Ordering data

Solder pin length		3.2 mm		
Colour		Orange		
Pitch		5.00 mm		
Pol.	L1	(inch)	Qty.	Order No.
2	5.00	0.197	100	1630480000
3	10.00	0.394	100	1630490000
4	15.00	0.591	100	1630500000
5	20.00	0.787	50	1630510000
6	25.00	0.984	50	1630520000
7	30.00	1.181	50	1630530000
8	35.00	1.378	50	1630540000
9	40.00	1.575	50	1630550000
10	45.00	1.772	50	1630560000
11	50.00	1.969	50	1630570000
12	55.00	2.165	50	1630580000
13	60.00	2.362	50	1630590000
14	65.00	2.559	50	1630600000
15	70.00	2.756	50	1630610000
16	75.00	2.953	50	1630620000
17	80.00	3.150	20	1630630000
18	85.00	3.346	20	1630640000
19	90.00	3.543	20	1630650000
20	95.00	3.740	20	1630660000
21	100.00	3.937	20	1630670000
22	105.00	4.134	20	1630680000
23	110.00	4.331	20	1630690000
24	115.00	4.528	20	1630700000

SLD 5.00/./90 & 180

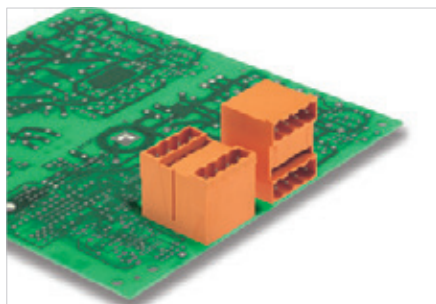

Double-level male header optimised for wave soldering. The connections are at the same level - with access that is flush over the front board. The male headers can be manually coded or ordered as pre-coded headers.

Technical data

In compliance with IEC 60664-1 / IEC 61984			
Clamping range, max.	mm ²		
Solid core H05(07) V-U	mm²		
Stranded H07 V-R			
Flexible H05(07) V-K	mm ²		
Flexible with ferrule	mm ²		
Ferrule with plastic collar	mm ²		
Stripping length	mm		
Screwdriver blade	mm		
According to norm			
Tightening torque range	Nm		
Rated current, max.	A	11	9.5
At ambient temperature		20°C	40°C
For conductor cross-section	mm ²		
Overtoltage category		III	III II
Pollution severity		3	2 2
Rated voltage	V	250	320 400
Rated impulse voltage	kV	4	4 4
UL / CUL (Use Group)		B	C D
Rated voltage	V	300	300
Rated current	A	10	10
AWG conductor	AWG		
CSA (Use Group)		B	C D
Rated voltage	V	300	300
Rated current	A	10	10
AWG conductor	AWG		
General data			
Type of insulation material		PBT	
UL 94 flammability rating		V-0	
Contact base material		CuSn	
Material of contact surface		tinned	
Pin dimensions = d	mm	1.2, Octagonal	
Solder eyelet Ø = D	mm	1.3	
Solder eyelet Ø tolerance	mm	+ 0,1	

Product data

IEC: 400 V / 11 A
UL: 300 V / 10 A

For additional articles and information, refer to catalog.weidmueller.com

Note:

- Additional colours on request
- Rated current related to rated cross-section & min. No. of poles.
- Spacing between rows: see hole layout
- P on drawing = pitch
- Rated data refer only to the component itself. Clearance and creepage distances to other components are to be designed in accordance with the relevant application standards.

SLD 5.00/./90G



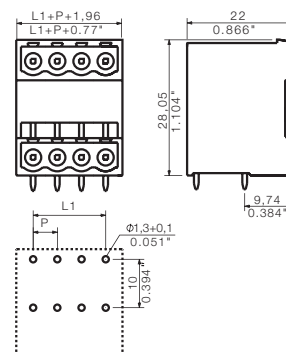

Dimensioned drawing



Accessories

Note: Refer to the Accessories chapter for additional accessories.

Coding		Order No.
	BLZ/SL KO OR	1573010000
	BLZ/SL KO SW	1545710000
Partition element		
	SL AT OR	1598300000
	SL AT SW	1770240000

Ordering data

Solder pin length		3.2 mm		
Colour		Orange		
Pitch	5.00 mm			
Pol.	L1	(inch)	Qty.	Order No.
4	5.00	0.197	50	1614350000
6	10.00	0.394	50	1614360000
8	15.00	0.591	50	1614370000
10	20.00	0.787	50	1614380000
12	25.00	0.984	50	1614390000
14	30.00	1.181	20	1614400000
16	35.00	1.378	20	1614410000
18	40.00	1.575	20	1614420000
20	45.00	1.772	20	1614430000
22	50.00	1.969	10	1614440000
24	55.00	2.165	10	1614450000
26	60.00	2.362	10	1614460000
28	65.00	2.559	10	1614470000
30	70.00	2.756	10	1614480000
32	75.00	2.953	10	1614490000
34	80.00	3.150	10	1614500000
36	85.00	3.346	10	1614510000
38	90.00	3.543	10	1614520000
40	95.00	3.740	10	1614530000
42	100.00	3.937	10	1614540000
44	105.00	4.134	10	1614550000
46	110.00	4.331	10	1614560000
48	115.00	4.528	10	1614570000

SLD 5.00/./180G



Dimensioned drawing

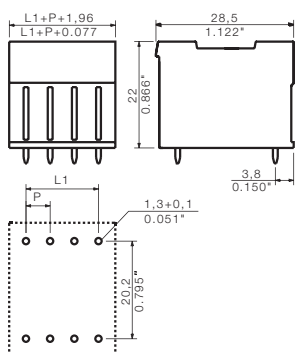

Ordering data

Solder pin length		3.2 mm		
Colour		Orange		
Pitch		5.00 mm		
Pol.	L1	(inch)	Qty.	Order No.
4	5.00	0.197	50	1614810000
6	10.00	0.394	50	1614820000
8	15.00	0.591	50	1614830000
10	20.00	0.787	50	1614840000
12	25.00	0.984	50	1614850000
14	30.00	1.181	20	1614860000
16	35.00	1.378	20	1614870000
18	40.00	1.575	20	1614880000
20	45.00	1.772	20	1614890000
22	50.00	1.969	10	1614900000
24	55.00	2.165	10	1614910000
26	60.00	2.362	10	1614920000
28	65.00	2.559	10	1614930000
30	70.00	2.756	10	1614940000
32	75.00	2.953	10	1614950000
34	80.00	3.150	10	1614960000
36	85.00	3.346	10	1614970000
38	90.00	3.543	10	1614980000
40	95.00	3.740	10	1614990000
42	100.00	3.937	10	1615000000
44	105.00	4.134	10	1615010000
46	110.00	4.331	10	1615020000
48	115.00	4.528	10	1615030000

BLZP 5.00/./180

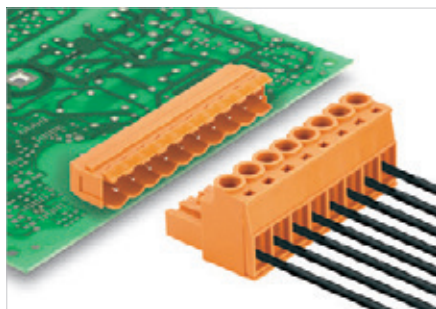

The BLZP is the functional extension of the BLZ series. The „P“ in the part name stands for a plus in security and performance in processing and use.

- WIRE READY - delivered with terminal points already opened
- Power tools can be used with the globally compatible plus/minus screw head
- Folded steel clamping yoke accommodates the connected wire and compensates for temperature fluctuations
- The integrated wire guard prevents dangerous under-insertion of the wire from occurring.
- Lock and release-lever: tool-less locking and gentle releasing of the connector reduces the mechanical stress on the solder joints.

Product data

IEC: 400 V / 19 A / 0.2 - 4 mm²
UL: 300 V / 15 A / AWG 30 - 12

For additional articles and information, refer to catalog.weidmueller.com

Note:

- Additional colours on request
- Rated current related to rated cross-section & min. No. of poles.
- Wire end ferrule without plastic collar to DIN 46228/1
- Wire end ferrule with plastic collar to DIN 46228/4
- P on drawing = pitch
- Rated data refer only to the component itself. Clearance and creepage distances to other components are to be designed in accordance with the relevant application standards.

BLZP 5.00/./180



Dimensioned drawing

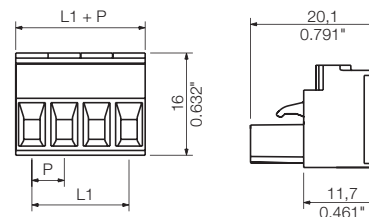

Technical data

In compliance with IEC 60664-1 / IEC 61984		
Clamping range, max.	mm ²	0.13...4
Solid core H05(07) V-U	mm²	0.2...4
Stranded H07 V-R		
Flexible H05(07) V-K	mm ²	0.2...4
Flexible with ferrule	mm ²	0.2...4
Ferrule with plastic collar	mm ²	0.2...2.5
Stripping length	mm	7
Screwdriver blade	mm	0.6 x 3.5, PH 0, PZ 0
According to norm		
Tightening torque range	Nm	0.4...0.5
Rated current, max.	A	19 16
At ambient temperature	20°C	40°C
For conductor cross-section	mm ²	4
Overvoltage category		III III II
Pollution severity		3 2 2
Rated voltage	V	250 320 400
Rated impulse voltage	kV	4 4 4
UL / CUL (Use Group)	B C D	D
Rated voltage	V	300 300
Rated current	A	15 10
AWG conductor	AWG	30-12
CSA (Use Group)	B C D	D
Rated voltage	V	300 50 300
Rated current	A	10 10 10
AWG conductor	AWG	30-12
General data		
Type of insulation material		PBT
UL 94 flammability rating		V-0
Contact base material		Copper alloy
Material of contact surface		tinned
Pin dimensions = d	mm	
Solder eyelet Ø = D	mm	
Solder eyelet Ø tolerance	mm	

Accessories

Note: Refer to the Accessories chapter for additional accessories.

Strain relief		Order No.
	BLZ 5.00 ZE4 OR	1652100000
	BLZ 5.00 ZE4 SW	1652120000
	BLZ 5.00 ZE8 OR	1652040000
	BLZ 5.00 ZE8 SW	1652060000
	BLZ/SL KO OR	1573010000
	BLZ/SL KO SW	1545710000
	SDIS 0.6X3.5X100	9008390000
	SDS 0.6X3.5X100	9008330000
	SDK PH1	9008480000
	SDK PZ1	9008530000

Ordering data

Solder pin length					
Colour	Orange		Black		
Pitch 5.00 mm					
Pol.	L1	(inch)	Qty.	Order No.	Order No.
2	5.00	0.197	100	1954490000	1955570000
3	10.00	0.394	100	1954480000	1955560000
4	15.00	0.591	100	1954470000	1955550000
5	20.00	0.787	45	1954460000	1955540000
6	25.00	0.984	45	1954450000	1955530000
7	30.00	1.181	45	1954440000	1955520000
8	35.00	1.378	45	1954430000	1955510000
9	40.00	1.575	45	1954420000	1955500000
10	45.00	1.772	45	1954410000	1955490000
11	50.00	1.969	36	1954400000	1955480000
12	55.00	2.165	36	1954390000	1955470000
13	60.00	2.362	36	1954380000	1955460000
14	65.00	2.559	27	1954370000	1955450000
15	70.00	2.756	27	1954360000	1955440000
16	75.00	2.953	27	1954350000	1955430000
17	80.00	3.150	18	1954330000	1955420000
18	85.00	3.346	18	1954320000	1955410000
19	90.00	3.543	18	1954310000	1955400000
20	95.00	3.740	18	1954300000	1955390000
21	100.00	3.937	18	1954290000	1955380000
22	105.00	4.134	18	1954280000	1955370000
23	110.00	4.331	18	1954270000	1955360000
24	115.00	4.528	18	1954260000	1955350000

Representative deratings curve

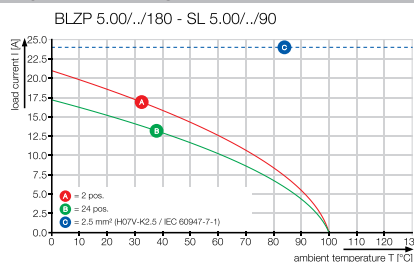

BLZP 5.00../180F



Dimensioned drawing

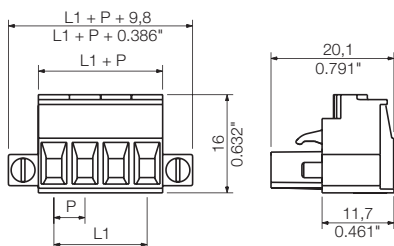

Ordering data

Solder pin length					
Colour		Orange	Black		
Pitch	5.00 mm				
Pol.	L1 (inch)	Qty.	Order No.	Order No.	
2	5.00	0.197	90	1955800000	1956030000
3	10.00	0.394	72	1955790000	1956020000
4	15.00	0.591	60	1955780000	1956010000
5	20.00	0.787	48	1955770000	1956000000
6	25.00	0.984	42	1955760000	1955990000
7	30.00	1.181	36	1955750000	1955980000
8	35.00	1.378	36	1955740000	1955970000
9	40.00	1.575	30	1955730000	1955960000
10	45.00	1.772	30	1955720000	1955950000
11	50.00	1.969	24	1955710000	1955940000
12	55.00	2.165	24	1955700000	1955930000
13	60.00	2.362	24	1955690000	1955920000
14	65.00	2.559	18	1955680000	1955910000
15	70.00	2.756	18	1955670000	1955900000
16	75.00	2.953	18	1955660000	1955890000
17	80.00	3.150	18	1955650000	1955880000
18	85.00	3.346	18	1955640000	1955870000
19	90.00	3.543	12	1955630000	1955860000
20	95.00	3.740	12	1955620000	1955850000
21	100.00	3.937	12	1955610000	1955840000
22	105.00	4.134	12	1955600000	1955830000
23	110.00	4.331	12	1955590000	1955820000
24	115.00	4.528	12	1955580000	1955810000

BLZP 5.00../180LR

with lock and release lever



Dimensioned drawing

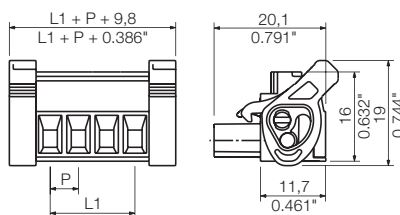

Ordering data

Solder pin length					
Colour		Orange	Black		
Pitch	5.00 mm				
Pol.	L1 (inch)	Qty.	Order No.	Order No.	
2	5.00	0.197	90	1956370000	1956600000
3	10.00	0.394	72	1956360000	1956590000
4	15.00	0.591	60	1956350000	1956580000
5	20.00	0.787	48	1956340000	1956570000
6	25.00	0.984	42	1956330000	1956560000
7	30.00	1.181	36	1956320000	1956550000
8	35.00	1.378	36	1956310000	1956540000
9	40.00	1.575	30	1956300000	1956530000
10	45.00	1.772	30	1956290000	1956520000
11	50.00	1.969	24	1956280000	1956510000
12	55.00	2.165	24	1956270000	1956500000
13	60.00	2.362	24	1956260000	1956490000
14	65.00	2.559	18	1956250000	1956480000
15	70.00	2.756	18	1956240000	1956470000
16	75.00	2.953	18	1956230000	1956460000
17	80.00	3.150	18	1956220000	1956450000
18	85.00	3.346	18	1956210000	1956440000
19	90.00	3.543	12	1956200000	1956430000
20	95.00	3.740	12	1956190000	1956420000
21	100.00	3.937	12	1956180000	1956410000
22	105.00	4.134	12	1956170000	1956400000
23	110.00	4.331	12	1956160000	1956390000
24	115.00	4.528	12	1956150000	1956380000

The 2-in-1 contact

Every pluggable connector covers two contact points and thus must meet two different requirements: First, the wire termination and second, the connection between plug and pin header. Referring to the 5.0x pitch series, Weidmüller offers different wire connection technologies, but one platform contact for the male / female connection since years. This well-designed hybride platform contact ensures a constant quality on a very high level. Hybride means, that we combine metal material featuring different characteristics by welding, in order to devide the contact system into different function zones: Further to the high electric conductance, the current bar is characterized by its hardness, and the tulip contact by its excellent tension properties. The advantage: each function is supported by the most suitable material to reliably and constantly meet the different electrical and mechanical requirements. To put it in a nutshell: Instead of either ... or, it's even both - perfect for the current, and perfect for the force.



Additional deratings curves

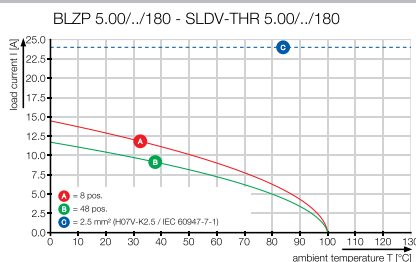
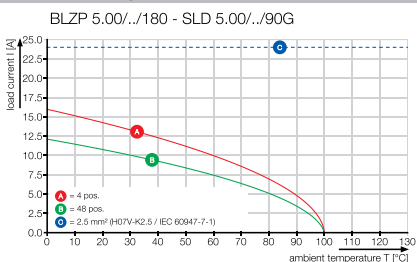

BLZP 5.00/./90

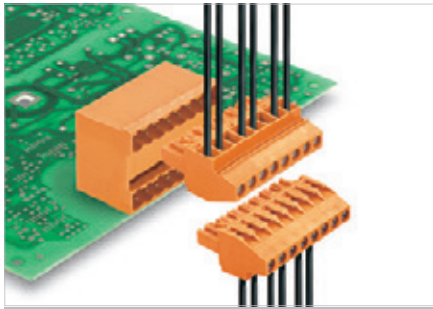

The BLZP is the functional extension of the BLZ series. The „P“ in the part name stands for a plus in security and performance in processing and use.

- WIRE READY – delivered with terminal points already opened
- Power tools can be used with the globally compatible plus/minus screw head
- Folded steel clamping yoke accommodates the connected wire and compensates for temperature fluctuations
- The integrated wire guard prevents dangerous under-insertion of the wire from occurring.
- Lock and release-lever: tool-less locking and gentle releasing of the connector reduces the mechanical stress on the solder joints.

Technical data

In compliance with IEC 60664-1 / IEC 61984			
Clamping range, max.	mm ²	0.13...4	
Solid core H05(07) V-U	mm²	0.2...4	
Stranded H07 V-R			
Flexible H05(07) V-K	mm ²	0.2...4	
Flexible with ferrule	mm ²	0.2...4	
Ferrule with plastic collar	mm ²	0.2...2.5	
Stripping length	mm	7	
Screwdriver blade	mm	0.6 x 3.5, PH 0, PZ 0	
According to norm			
Tightening torque range	Nm	0.4...0.5	
Rated current, max.	A	15.5	12
At ambient temperature		20°C	40°C
For conductor cross-section	mm ²	4	
Overvoltage category		III	III II
Pollution severity		3	2 2
Rated voltage	V	250	320 400
Rated impulse voltage	kV	4	4 4
UL / CUL (Use Group)	B C D	B	C D
Rated voltage	V	300	300
Rated current	A	15	10
AWG conductor	AWG	30-12	
CSA (Use Group)	B C D	B	C D
Rated voltage	V	300	50 300
Rated current	A	10	10 10
AWG conductor	AWG	30-12	
General data			
Type of insulation material		PBT	
UL 94 flammability rating		V-0	
Contact base material		Copper alloy	
Material of contact surface		tinned	
Pin dimensions = d	mm		
Solder eyelet Ø = D	mm		
Solder eyelet Ø tolerance	mm		

Product data

IEC: 400 V / 15.5 A / 0.2 - 4 mm²
UL: 300 V / 15 A / AWG 30 - 12

For additional articles and information, refer to catalog.weidmueller.com

Note:

- Additional colours on request
- Rated current related to rated cross-section & min. No. of poles.
- Wire end ferrule without plastic collar to DIN 46228/1
- Wire end ferrule with plastic collar to DIN 46228/4
- P on drawing = pitch
- Rated data refer only to the component itself. Clearance and creepage distances to other components are to be designed in accordance with the relevant application standards.

BLZP 5.00/./90



Dimensioned drawing

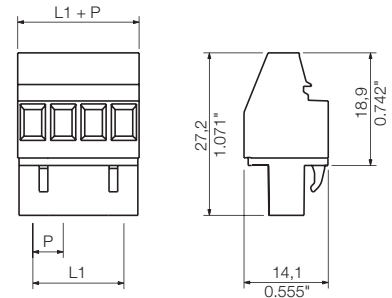

Accessories

Note: Refer to the Accessories chapter for additional accessories.

Coding		Order No.
	BLZ/SL KO OR	1573010000
	BLZ/SL KO SW	1545710000
Screwdriver		
	SDIS 0.6X3.5X100	9008390000
	SDS 0.6X3.5X100	9008330000
Crosshead screwdriver		
	SDK PH1	9008480000
	SDK PZ1	9008530000

Ordering data

Solder pin length						
Colour	Orange		Black			
Pitch 5.00 mm						
Pol.	L1	(inch)	Qty.	Order No.	Order No.	
2	5.00	0.197	180	1958300000	1958650000	
3	10.00	0.394	120	1958290000	1958640000	
4	15.00	0.591	90	1958280000	1958630000	
5	20.00	0.787	72	1958270000	1958620000	
6	25.00	0.984	60	1958260000	1958610000	
7	30.00	1.181	48	1958250000	1958600000	
8	35.00	1.378	42	1958230000	1958590000	
9	40.00	1.575	36	1958190000	1958580000	
10	45.00	1.772	36	1958160000	1958570000	
11	50.00	1.969	30	1958130000	1958560000	
12	55.00	2.165	30	1958120000	1958550000	
13	60.00	2.362	24	1958090000	1958540000	
14	65.00	2.559	24	1958060000	1958530000	
15	70.00	2.756	24	1958040000	1958520000	
16	75.00	2.953	18	1957960000	1958480000	
17	80.00	3.150	18	1957910000	1958460000	
18	85.00	3.346	18	1957900000	1958430000	
19	90.00	3.543	18	1957880000	1958420000	
20	95.00	3.740	18	1957850000	1958400000	
21	100.00	3.937	12	1957830000	1958380000	
22	105.00	4.134	12	1957820000	1958360000	
23	110.00	4.331	12	1957800000	1958340000	
24	115.00	4.528	12	1957780000	1958310000	

Representative deratings curve

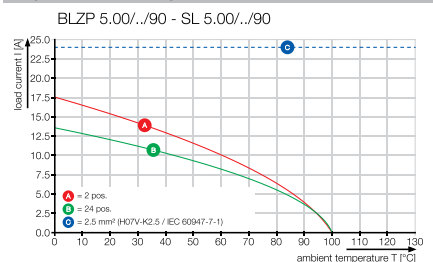

BLZP 5.00/./90F



Dimensioned drawing

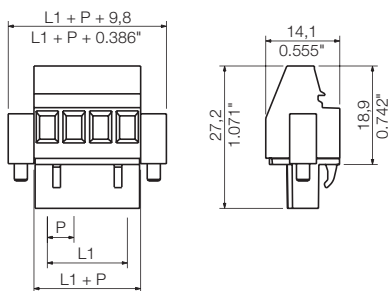

Ordering data

Solder pin length		Colour		Order No.	
Colour	Orange	Black			
Pitch	5.00 mm				
Pol.	L1 (mm)	L1 (inch)	Qty.	Order No.	Order No.
2	5.00	0.197	90	1959520000	1959750000
3	10.00	0.394	72	1959510000	1959740000
4	15.00	0.591	60	1959500000	1959730000
5	20.00	0.787	48	1959490000	1959720000
6	25.00	0.984	42	1959480000	1959710000
7	30.00	1.181	36	1959470000	1959700000
8	35.00	1.378	36	1959460000	1959690000
9	40.00	1.575	30	1959440000	1959680000
10	45.00	1.772	30	1959430000	1959670000
11	50.00	1.969	24	1959390000	1959660000
12	55.00	2.165	24	1959370000	1959650000
13	60.00	2.362	24	1959360000	1959640000
14	65.00	2.559	18	1959350000	1959630000
15	70.00	2.756	18	1959340000	1959620000
16	75.00	2.953	18	1959330000	1959610000
17	80.00	3.150	18	1959320000	1959600000
18	85.00	3.346	18	1959300000	1959590000
19	90.00	3.543	12	1959290000	1959580000
20	95.00	3.740	12	1959270000	1959570000
21	100.00	3.937	12	1959250000	1959560000
22	105.00	4.134	12	1959240000	1959550000
23	110.00	4.331	12	1959220000	1959540000
24	115.00	4.528	12	1959200000	1959530000

The 2-in-1 contact

Every pluggable connector covers two contact points and thus must meet two different requirements: First, the wire termination and second, the connection between plug and pin header. Referring to the 5.0x pitch series, Weidmüller offers different wire connection technologies, but one platform contact for the male / female connection since years. This well-designed hybride platform contact ensures a constant quality on a very high level. Hybride means, that we combine metal material featuring different characteristics by welding, in order to devide the contact system into different function zones: Further to the high electric conductance, the current bar is characterized by its hardness, and the tulip contact by its excellent tension properties. The advantage: each function is supported by the most suitable material to reliably and constantly meet the different electrical and mechanical requirements. To put it in a nutshell: Instead of either ... or, it 's even both - perfect for the current, and perfect for the force.



Additional deratings curves

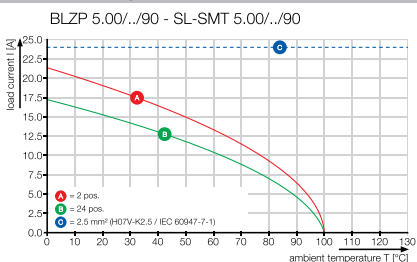

BLZP 5.00/./270

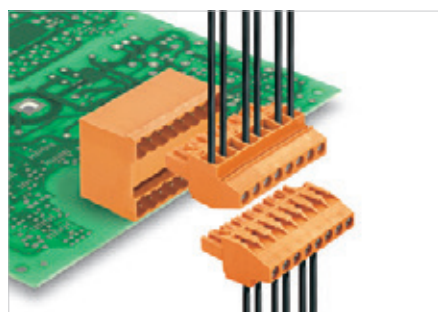

The BLZP is the functional extension of the BLZ series. The „P“ in the part name stands for a plus in security and performance in processing and use.

- WIRE READY - delivered with terminal points already opened
- Power tools can be used with the globally compatible plus/minus screw head
- Folded steel clamping yoke accommodates the connected wire and compensates for temperature fluctuations
- The integrated wire guard prevents dangerous under-insertion of the wire from occurring.
- Lock and release-lever: tool-less locking and gentle releasing of the connector reduces the mechanical stress on the solder joints.

Product data

IEC: 400 V / 15.5 A / 0.2 - 4 mm²
UL: 300 V / 15 A / AWG 30 - 12

For additional articles and information, refer to catalog.weidmueller.com

Note:

- Additional colours on request
- Rated current related to rated cross-section & min. No. of poles.
- Wire end ferrule without plastic collar to DIN 46228/1
- Wire end ferrule with plastic collar to DIN 46228/4
- P on drawing = pitch
- Rated data refer only to the component itself. Clearance and creepage distances to other components are to be designed in accordance with the relevant application standards.

BLZP 5.00/./270



Dimensioned drawing

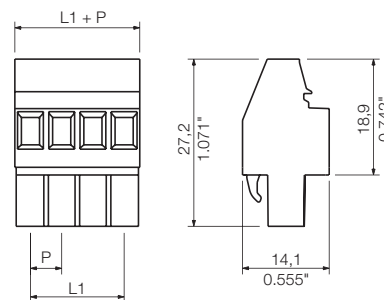

Technical data

In compliance with IEC 60664-1 / IEC 61984			
Clamping range, max.	mm ²	0.13...4	
Solid core H05(07) V-U	mm²	0.2...4	
Stranded H07 V-R			
Flexible H05(07) V-K	mm ²	0.2...4	
Flexible with ferrule	mm ²	0.2...4	
Ferrule with plastic collar	mm ²	0.2...2.5	
Stripping length	mm	7	
Screwdriver blade	mm	0.6 x 3.5, PH 0, PZ 0	
According to norm			
Tightening torque range	Nm	0.4...0.5	
Rated current, max.	A	15.5	12
At ambient temperature			
		20°C	40°C
For conductor cross-section	mm ²	4	
Overvoltage category		III	III II
Pollution severity		3	2 2
Rated voltage	V	250	320 400
Rated impulse voltage	kV	4 4 4	
UL / CUL (Use Group)	B C D	D	
Rated voltage	V	300	300
Rated current	A	15	10
AWG conductor	AWG	30-12	
CSA (Use Group)	B C D	D	
Rated voltage	V	300	50 300
Rated current	A	10	10
AWG conductor	AWG	30-12	
General data			
Type of insulation material		PBT	
UL 94 flammability rating		V-0	
Contact base material		Copper alloy	
Material of contact surface		tinned	
Pin dimensions = d	mm		
Solder eyelet Ø = D	mm		
Solder eyelet Ø tolerance	mm		

Accessories

Note: Refer to the Accessories chapter for additional accessories.

Coding		Order No.
	BLZ/SL KO OR	1573010000
	BLZ/SL KO SW	1545710000
Screwdriver		
	SDIS 0.6X3.5X100	9008390000
	SDS 0.6X3.5X100	9008330000
Crosshead screwdriver		
	SDK PH1	9008480000
	SDK PZ1	9008530000

Ordering data

Solder pin length						
Colour	Orange		Black			
Pitch	5.00 mm					
Pol.	L1	(inch)	Qty.	Order No.	Order No.	
2	5.00	0.197	180	1958870000	1959100000	
3	10.00	0.394	120	1958860000	1959090000	
4	15.00	0.591	90	1958850000	1959080000	
5	20.00	0.787	72	1958840000	1959070000	
6	25.00	0.984	60	1958830000	1959060000	
7	30.00	1.181	48	1958820000	1959050000	
8	35.00	1.378	42	1958810000	1959040000	
9	40.00	1.575	36	1958800000	1959030000	
10	45.00	1.772	36	1958790000	1959020000	
11	50.00	1.969	30	1958780000	1959010000	
12	55.00	2.165	30	1959150000	1959000000	
13	60.00	2.362	24	1958770000	1958990000	
14	65.00	2.559	24	1958760000	1958980000	
15	70.00	2.756	24	1958750000	1958970000	
16	75.00	2.953	18	1958740000	1958960000	
17	80.00	3.150	18	1958730000	1958950000	
18	85.00	3.346	18	1958720000	1958940000	
19	90.00	3.543	18	1958710000	1958930000	
20	95.00	3.740	18	1958700000	1958920000	
21	100.00	3.937	12	1958690000	1958910000	
22	105.00	4.134	12	1958680000	1958900000	
23	110.00	4.331	12	1958670000	1958890000	
24	115.00	4.528	12	1958660000	1958880000	

Representative deratings curve

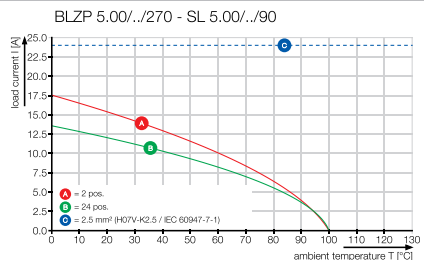

BLZP 5.00/./270F



Dimensioned drawing

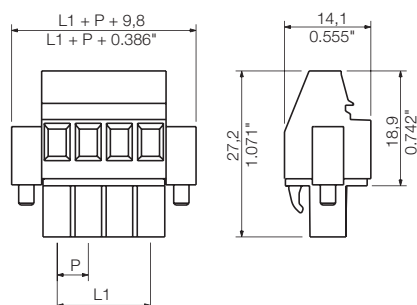

Ordering data

Solder pin length					
Colour	Orange	Black			
Pitch	5.00 mm				
Pol.	L1 (inch)	Qty.	Order No.	Order No.	
2	5.00 0.197	90	1960460000	1960730000	
3	10.00 0.394	72	1960450000	1960720000	
4	15.00 0.591	60	1960440000	1960710000	
5	20.00 0.787	48	1960430000	1960700000	
6	25.00 0.984	42	1960420000	1960690000	
7	30.00 1.181	36	1960410000	1960670000	
8	35.00 1.378	36	1960400000	1960660000	
9	40.00 1.575	30	1960390000	1960650000	
10	45.00 1.772	30	1960380000	1960640000	
11	50.00 1.969	24	1960370000	1960630000	
12	55.00 2.165	24	1959450000	1960620000	
13	60.00 2.362	24	1959420000	1960610000	
14	65.00 2.559	18	1959410000	1960600000	
15	70.00 2.756	18	1959400000	1960590000	
16	75.00 2.953	18	1959380000	1960580000	
17	80.00 3.150	18	1959310000	1960570000	
18	85.00 3.346	18	1959280000	1960560000	
19	90.00 3.543	12	1959260000	1960550000	
20	95.00 3.740	12	1959230000	1960540000	
21	100.00 3.937	12	1959210000	1960530000	
22	105.00 4.134	12	1959190000	1960520000	
23	110.00 4.331	12	1959180000	1960510000	
24	115.00 4.528	12	1959170000	1960500000	

BLZP 5.00/./270LR

with lock and release lever



Dimensioned drawing

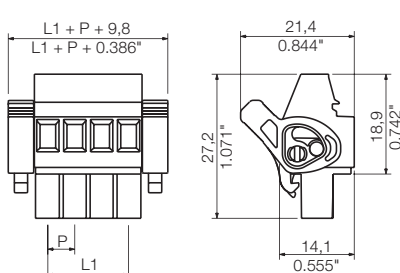

Ordering data

Solder pin length					
Colour	Orange	Black			
Pitch	5.00 mm				
Pol.	L1 (inch)	Qty.	Order No.	Order No.	
2	5.00 0.197	90	1960960000	1961190000	
3	10.00 0.394	72	1960950000	1961180000	
4	15.00 0.591	60	1960940000	1961170000	
5	20.00 0.787	48	1960930000	1961160000	
6	25.00 0.984	42	1960920000	1961150000	
7	30.00 1.181	36	1960910000	1961140000	
8	35.00 1.378	36	1960900000	1961130000	
9	40.00 1.575	30	1960890000	1961120000	
10	45.00 1.772	30	1960880000	1961110000	
11	50.00 1.969	24	1960870000	1961100000	
12	55.00 2.165	24	1960860000	1961090000	
13	60.00 2.362	24	1960850000	1961080000	
14	65.00 2.559	18	1960840000	1961070000	
15	70.00 2.756	18	1960830000	1961060000	
16	75.00 2.953	18	1960820000	1961050000	
17	80.00 3.150	18	1960810000	1961040000	
18	85.00 3.346	18	1960800000	1961030000	
19	90.00 3.543	12	1960790000	1961020000	
20	95.00 3.740	12	1960780000	1961010000	
21	100.00 3.937	12	1960770000	1961000000	
22	105.00 4.134	12	1960760000	1960990000	
23	110.00 4.331	12	1960750000	1960980000	
24	115.00 4.528	12	1960740000	1960970000	

The 2-in-1 contact

Every pluggable connector covers two contact points and thus must meet two different requirements: First, the wire termination and second, the connection between plug and pin header. Referring to the 5.0x pitch series, Weidmüller offers different wire connection technologies, but one platform contact for the male / female connection since years. This well-designed hybride platform contact ensures a constant quality on a very high level. Hybride means, that we combine metal material featuring different characteristics by welding, in order to devide the contact system into different function zones: Further to the high electric conductance, the current bar is characterized by its hardness, and the tulip contact by its excellent tension properties. The advantage: each function is supported by the most suitable material to reliably and constantly meet the different electrical and mechanical requirements. To put it in a nutshell: Instead of either ... or, it's even both - perfect for the current, and perfect for the force.



BLF 5.00/./180

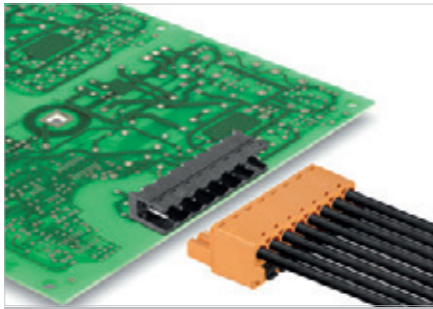

PUSH IN - Weidmüller's innovative connection system simplifies and accelerates the wire connection process.

- Solid wires and stranded wires with ferrules need only to be inserted and they are ready.
- The actuator must be used when connecting stranded wires without ferrules.
- Intuitive handling - since the wire-entry area and handling area are clearly separated.
- User-friendly handling with rounded outer edges and large, no-slip push buttons.
- Lock and release lever: tool-less locking and a gentle releasing of the connector reduces the mechanical stress to the solder joints.

Technical data

In compliance with IEC 60664-1 / IEC 61984			
Clamping range, max.	mm ²	0.13...3.31	
Solid core H05(07) V-U	mm²	0.2...2.5	
Stranded H07 V-R		0..2	
Flexible H05(07) V-K	mm ²	0.2...2.5	
Flexible with ferrule	mm ²	0.2..2.5	
Ferrule with plastic collar	mm ²	0.2...2.5	
Stripping length	mm	10	
Screwdriver blade	mm	0.6 x 3.5	
According to norm			
Tightening torque range	Nm		
Rated current, max.	A	20.5	17.5
At ambient temperature		20°C	40°C
For conductor cross-section	mm ²	2.5	
Overvoltage category		III	III II
Pollution severity		3	2 2
Rated voltage	V	250	320 400
Rated impulse voltage	kV	4	4 4
UL / CUL (Use Group)	B C D	B	C D
Rated voltage	V	300	300
Rated current	A	10	10
AWG conductor	AWG	12-26	
CSA (Use Group)	B C D	B	C D
Rated voltage	V	300	300
Rated current	A	10	10
AWG conductor	AWG	12-26	
General data			
Type of insulation material		PBT	
UL 94 flammability rating		V-0	
Contact base material		CuSn	
Material of contact surface		tinned	
Pin dimensions = d	mm		
Solder eyelet Ø = D	mm		
Solder eyelet Ø tolerance	mm		

Product data

IEC: 400 V / 20.5 A / 0.2 - 2.5 mm²
UL: 300 V / 10 A / AWG 12 - 26

For additional articles and information, refer to catalog.weidmuller.com

Note:

- Additional colours on request
- Gold-plated contact surfaces on request
- Rated current related to rated cross-section & min. No. of poles.
- Wire end ferrule without plastic collar to DIN 46228/1
- Wire end ferrule with plastic collar to DIN 46228/4
- P on drawing = pitch

BLF 5.00/./180



Dimensioned drawing

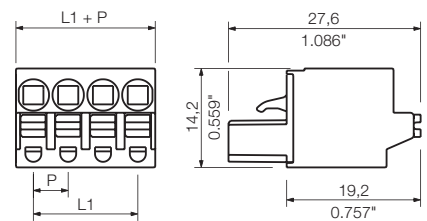

Accessories

Note: Refer to the Accessories chapter for additional accessories.

Coding		Order No.
	BLZ/SL KO OR	1573010000
	BLZ/SL KO SW	1545710000
Screwdriver		
	SDIS 0.6X3.5X100	9008390000
	SDS 0.6X3.5X100	9008330000
Wire-end ferrule		
	H0,5/14S W	9004590000
	H1,0/14S R	9018560000
	H1,5/14S SW	9025240000
	H2,5/14S BL	1333100000

Ordering data

Solder pin length						
Colour	Orange		Black			
Pitch	5.00 mm					
Pol.	L1	(inch)	Qty.	Order No.	Order No.	
2	5.00	0.197	180	1017860000	1017670000	
3	10.00	0.394	120	1017870000	1017680000	
4	15.00	0.591	90	1017880000	1017690000	
5	20.00	0.788	72	1017890000	1017710000	
6	25.00	0.985	60	1017910000	1017720000	
7	30.00	1.182	48	1017920000	1017730000	
8	35.00	1.379	42	1017930000	1017740000	
9	40.00	1.576	36	1017950000	1017750000	
10	45.00	1.773	36	1017960000	1017760000	
11	50.00	1.970	30	1017970000	1017770000	
12	55.00	2.167	30	1017980000	1017780000	
13	60.00	2.364	24	1017990000	1017790000	
14	65.00	2.561	24	1018010000	1017810000	
15	70.00	2.758	24	1018020000	1017820000	
16	75.00	2.955	18	1018030000	1017830000	
17	80.00	3.152	18	1018040000	1017840000	
18	85.00	3.349	18	1018050000	1017850000	

Representative deratings curve

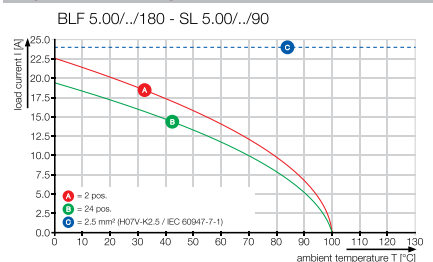

BLF 5.00/././180F



Dimensioned drawing

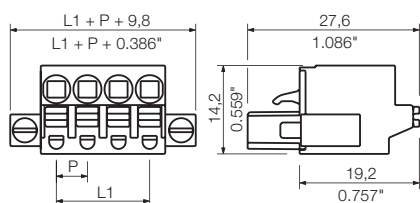

Ordering data

Solder pin length						
Colour		Orange	Black			
Pitch	5.00 mm					
Pol.	L1	(inch)	Qty.	Order No.	Order No.	
2	5.00	0.197	90	1017420000	1017240000	
3	10.00	0.394	72	1017430000	1017250000	
4	15.00	0.591	60	1017440000	1017260000	
5	20.00	0.788	48	1017450000	1017270000	
6	25.00	0.985	42	1017470000	1017280000	
7	30.00	1.182	36	1017480000	1017290000	
8	35.00	1.379	36	1017490000	1017310000	
9	40.00	1.576	30	1017510000	1017320000	
10	45.00	1.773	30	1017520000	1017330000	
11	50.00	1.970	24	1017530000	1017340000	
12	55.00	2.167	24	1017540000	1017350000	
13	60.00	2.364	24	1017550000	1017360000	
14	65.00	2.561	18	1017570000	1017370000	
15	70.00	2.758	18	1017590000	1017380000	
16	75.00	2.955	18	1017600000	1017390000	
17	80.00	3.152	18	1017610000	1017400000	
18	85.00	3.349	18	1017620000	1017410000	

BLF 5.00/././180LR



Dimensioned drawing

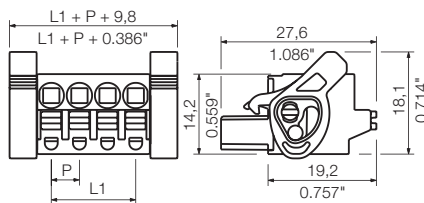

Ordering data

Solder pin length						
Colour		Orange	Black			
Pitch	5.00 mm					
Pol.	L1	(inch)	Qty.	Order No.	Order No.	
2	5.00	0.197	90	1016340000	1016140000	
3	10.00	0.394	72	1016350000	1016150000	
4	15.00	0.591	60	1016360000	1016170000	
5	20.00	0.788	48	1016370000	1016180000	
6	25.00	0.985	42	1016380000	1016190000	
7	30.00	1.182	36	1016390000	1016210000	
8	35.00	1.379	36	1016410000	1016220000	
9	40.00	1.576	30	1016420000	1016230000	
10	45.00	1.773	30	1016430000	1016240000	
11	50.00	1.970	24	1016440000	1016250000	
12	55.00	2.167	24	1016450000	1016260000	
13	60.00	2.364	24	1016460000	1016270000	
14	65.00	2.561	18	1016470000	1016280000	
15	70.00	2.758	18	1016480000	1016290000	
16	75.00	2.955	18	1016490000	1016310000	
17	80.00	3.152	18	1016510000	1016320000	
18	85.00	3.349	18	1016520000	1016330000	

PUSH IN connection technology

PUSH IN connection technology reduces the wiring efforts especially for solid wires and wires with ferrule to a minimum. These connectors are self-explanatory and enable tool-less handling. The contact element made of stainless steel ensures a vibration proof, maintenance free wire termination. The established principle „STEEL FOR THE FORCE, COPPER FOR THE CURRENT“ by Weidmüller offers both, maximum conductor clamping forces, as well as minimum power loss at the same time.

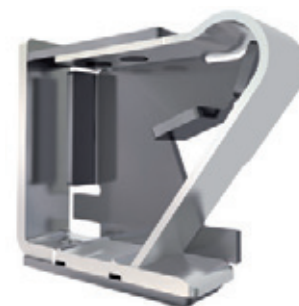

The 2-in-1 contact

Every pluggable connector covers two contact points and thus must meet two different requirements: First, the wire termination and second, the connection between plug and pin header. Referring to the 5.0x pitch series, Weidmüller offers different wire connection technologies, but one platform contact for the male / female connection since years. This well-designed hybride platform contact ensures a constant quality on a very high level. Hybride means, that we combine metal material featuring different characteristics by welding, in order to divide the contact system into different function zones: Further to the high electric conductance, the current bar is characterized by its hardness, and the tulip contact by its excellent tension properties. The advantage: each function is supported by the most suitable material to reliably and constantly meet the different electrical and mechanical requirements. To put it in a nutshell: Instead of either ... or, it's even both - perfect for the current, and perfect for the force.



BLF 5.00/./90

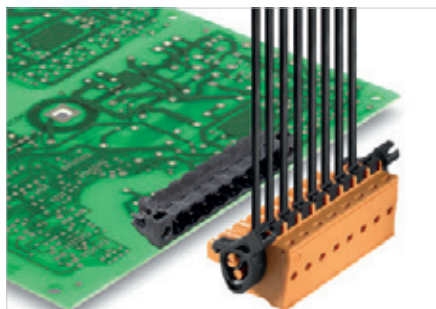

PUSH IN - Weidmüller's innovative connection system simplifies and accelerates the wire connection process.

- Solid wires and stranded wires with ferrules need only to be inserted and they are ready.
- The actuator must be used when connecting stranded wires without ferrules.
- Intuitive handling - since the wire-entry area and handling area are clearly separated.
- User-friendly handling with rounded outer edges and large, no-slip push buttons.
- Lock and release lever: tool-less locking and a gentle releasing of the connector reduces the mechanical stress to the solder joints.

Technical data

In compliance with IEC 60664-1 / IEC 61984			
Clamping range, max.	mm ²	0.13...3.31	
Solid core H05(07) V-U	mm ²	0.2...2.5	
Stranded H07 V-R		0...2	
Flexible H05(07) V-K	mm ²	0.2...2.5	
Flexible with ferrule	mm ²	0.2...2.5	
Ferrule with plastic collar	mm ²	0.2...2.5	
Stripping length	mm	10	
Screwdriver blade	mm	0.6 x 3.5	
According to norm		DIN 5264	
Tightening torque range	Nm		
Rated current, max.	A	20	17
At ambient temperature		20°C	40°C
For conductor cross-section	mm ²	2.5	
Overvoltage category		III	III II
Pollution severity		3	2 2
Rated voltage	V	250	320 400
Rated impulse voltage	kV	4	4 4
UL / CUL (Use Group)	B C D	B C D	B C D
Rated voltage	V	300	300
Rated current	A	10	10
AWG conductor	AWG	12-26	
CSA (Use Group)	B C D	B C D	B C D
Rated voltage	V	300	300
Rated current	A	10	10
AWG conductor	AWG	12-26	
General data			
Type of insulation material		PBT	
UL 94 flammability rating		V-0	
Contact base material		CuSn	
Material of contact surface		tinned	
Pin dimensions = d	mm		
Solder eyelet Ø = D	mm		
Solder eyelet Ø tolerance	mm		

Product data

IEC: 400 V / 20 A / 0.2 - 2.5 mm²
UL: 300 V / 10 A / AWG 12 - 26

For additional articles and information, refer to catalog.weidmueller.com

- Note:**
- Additional colours on request
 - Gold-plated contact surfaces on request
 - Rated current related to rated cross-section & min. No. of poles.
 - Wire end ferrule without plastic collar to DIN 46228/1
 - Wire end ferrule with plastic collar to DIN 46228/4
 - P on drawing = pitch

BLF 5.00/./90



Dimensioned drawing

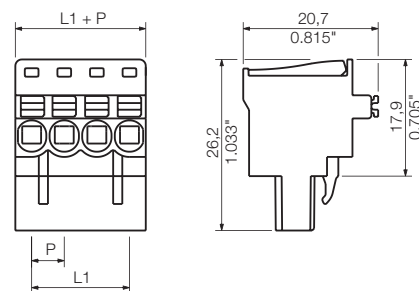

Accessories

Note: Refer to the Accessories chapter for additional accessories.

Coding		Order No.
	BLZ/SL KO OR	1573010000
	BLZ/SL KO SW	1545710000
Screwdriver		
	SDIS 0.6X3.5X100	9008390000
	SDS 0.6X3.5X100	9008330000
Wire-end ferrule		
	H0,5/14S W	9004590000
	H1,0/14S R	9018560000
	H1,5/14S SW	9025240000
	H2,5/14S BL	1333100000

Ordering data

Solder pin length						
Colour	Orange		Black			
Pitch 5.00 mm						
Pol.	L1	(inch)	Qty.	Order No.	Order No.	
2	5.00	0.197	180	1980170000	1979270000	
3	10.00	0.394	120	1980180000	1979280000	
4	15.00	0.591	90	1980190000	1979290000	
5	20.00	0.788	72	1980200000	1979300000	
6	25.00	0.985	60	1980210000	1979310000	
7	30.00	1.182	48	1980220000	1979320000	
8	35.00	1.379	42	1980230000	1979330000	
9	40.00	1.576	36	1980240000	1979340000	
10	45.00	1.773	36	1980250000	1979350000	
11	50.00	1.970	30	1980260000	1979360000	
12	55.00	2.167	30	1980270000	1979370000	
13	60.00	2.364	24	1980280000	1979380000	
14	65.00	2.561	24	1980290000	1979390000	
15	70.00	2.758	24	1980300000	1979400000	
16	75.00	2.955	18	1980310000	1979410000	
17	80.00	3.152	18	1980320000	1979420000	
18	85.00	3.349	18	1980330000	1979430000	
19	90.00	3.546	18	1980340000	1979440000	
20	95.00	3.743	18	1980360000	1979450000	

Representative deratings curve

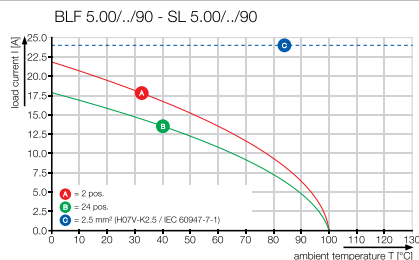

BLF 5.00/./90F



Dimensioned drawing

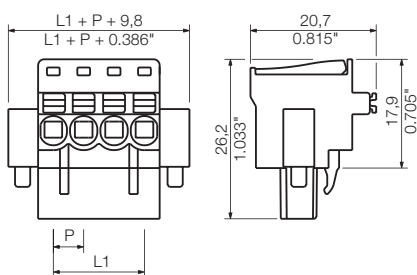

Ordering data

Solder pin length						
Colour		Orange	Black			
Pitch	5.00 mm					
Pol.	L1	(inch)	Qty.	Order No.	Order No.	
2	5.00	0.197	90	1980640000	1979460000	
3	10.00	0.394	72	1980650000	1979470000	
4	15.00	0.591	60	1980660000	1979480000	
5	20.00	0.788	48	1980670000	1979490000	
6	25.00	0.985	42	1980680000	1979500000	
7	30.00	1.182	36	1980690000	1979510000	
8	35.00	1.379	36	1980700000	1979520000	
9	40.00	1.576	30	1980710000	1979530000	
10	45.00	1.773	30	1980720000	1979540000	
11	50.00	1.970	24	1980730000	1979550000	
12	55.00	2.167	24	1980740000	1979560000	
13	60.00	2.364	24	1980750000	1979570000	
14	65.00	2.561	18	1980760000	1979580000	
15	70.00	2.758	18	1980780000	1979590000	
16	75.00	2.955	18	1980790000	1979600000	
17	80.00	3.152	18	1980800000	1979610000	
18	85.00	3.349	18	1980810000	1979620000	
19	90.00	3.546	12	1980820000	1979630000	
20	95.00	3.743	12	1980840000	1979640000	

BLF 5.00/./90LR

with lock and release lever



Dimensioned drawing

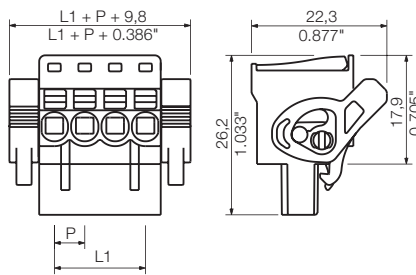

Ordering data

Solder pin length						
Colour		Orange	Black			
Pitch	5.00 mm					
Pol.	L1	(inch)	Qty.	Order No.	Order No.	
2	5.00	0.197	90	1980870000	1979790000	
3	10.00	0.394	72	1980880000	1979800000	
4	15.00	0.591	60	1980890000	1979810000	
5	20.00	0.788	48	1980900000	1979820000	
6	25.00	0.985	42	1980910000	1979830000	
7	30.00	1.182	36	1980920000	1979840000	
8	35.00	1.379	36	1980930000	1979850000	
9	40.00	1.576	30	1980940000	1979860000	
10	45.00	1.773	30	1980950000	1979870000	
11	50.00	1.970	24	1980960000	1979880000	
12	55.00	2.167	24	1980970000	1979890000	
13	60.00	2.364	24	1980980000	1979900000	
14	65.00	2.561	18	1980990000	1979910000	
15	70.00	2.758	18	1981000000	1979920000	
16	75.00	2.955	18	1981010000	1979930000	
17	80.00	3.152	18	1981020000	1979940000	
18	85.00	3.349	18	1981030000	1979950000	
19	90.00	3.546	12	1981040000	1979960000	
20	95.00	3.743	12	1981050000	1979970000	

PUSH IN connection technology

PUSH IN connection technology reduces the wiring affords especially for solid wires and wires with ferrule to a minimum. These connectors are self-explanatory and enable tool-less handling. The contact element made of stainless steel ensures a vibration proof, maintenance free wire termination. The established principle „STEEL FOR THE FORCE, COPPER FOR THE CURRENT“ by Weidmüller offers both, maximum conductor clamping forces, as well as minimum power loss at the same time.







The 2-in-1 contact

Every pluggable connector covers two contact points and thus must meet two different requirements: First, the wire termination and second, the connection between plug and pin header. Referring to the 5.0x pitch series, Weidmüller offers different wire connection technologies, but one platform contact for the male / female connection since years. This well-designed hybride platform contact ensures a constant quality on a very high level. Hybride means, that we combine metal material featuring different characteristics by welding, in order to devide the contact system into different function zones: Further to the high electric conductance, the current bar is characterized by its hardness, and the tulip contact by its excellent tension properties. The advantage: each function is supported by the most suitable material to reliably and constantly meet the different electrical and mechanical requirements. To put it in a nutshell: Instead of either ... or, it 's even both - perfect for the current, and perfect for the force.



<http://www.OMNIMATE.net>

-  = Wire-to-Board
-  = Board-to-Board
-  = Wire-to-Wire
-  = Board-to-Wire



Orientation

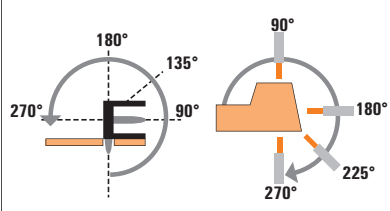

 **Solder connection**

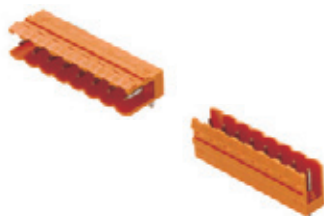

C

BL/SL 5.08 series, Part 1 of 3



Type	Levels	
	1	
Orientation	90°	180°
Flange options Male headers	(O)/G/B/F/LF	(O)/G/B/F/LF
IEC / UL	IEC: 400 V/24 A UL: 300 V/15 A	IEC: 400 V/24 A UL: 300 V/16 A
Page	C.190	C.194

	Image	Type	Orientation	Flange options	IEC / UL	Page	Levels		
							1		
Female plug		BLZP	180°	(G)/F/LR	IEC: 400 V/19 A/0.2 - 4 mm ² UL: 300 V/10 A/AWG 26 - 12	C.218			
			90°	(G)/F/LR	IEC: 400 V/15.5 A/0.2 - 4 mm ² UL: 300 V/10 A/AWG 26 - 12	C.220			
			270°	(G)/F/LR	IEC: 400 V/15.5 A/0.2 - 4 mm ² UL: 300 V/10 A/AWG 26 - 12	C.222			
			225°	(G)/F/LR	IEC: 400 V/17.5 A/0.2 - 4 mm ² UL: 300 V/10 A/AWG 26 - 12	C.224			
Female plug		BLT	180°	(G)/F/LR/DF	IEC: 400 V/17 A/0.2 - 2.5 mm ² UL: 300 V/10 A/AWG 26 - 14	C.226			
			BLZ QV	180°	(G)	IEC: 400 V/17.5 A/0.2 - 2.5 mm ² UL: 300 V/15 A/AWG 26 - 14	C.228		
				BLDZ DN Devicenet	180°	(G)/F	IEC: 400 V/16 A/0.2 - 2.5 mm ² UL: 300 V/15 A/AWG 22 - 12	C.232	
Female plug		BLDT	180°	(G)	IEC: 400 V/14 A/0.2 - 2.5 mm ² UL: 300 V/10 A/AWG 26 - 12	C.234			
			Female header		BLL	90°	(G)/FI	IEC: 400 V/23 A UL: 300 V/15 A	C.246
180°	(G)/B	IEC: 400 V/23 A UL: 300 V/15 A				C.248			

Female plug and header:

- (G)* = Closed (without flange)
- F = Flange with screw
- DF = Implementation

- LR = Lock & Release lever
- B = Dovetail for fixing blocks with a nut
- FI = Inverted flange with nut

* not included in the article description

Male header



Solder connection



Reflow solder connection



	2				1		
	SLD	SLD	SLDV	SLDV	SL-SMT	SL-SMT	SL-SMT
	90°	180°	90°	180°	90°	180°	270°
	G	G	(O)/B	(O)/B	(O)/G/F/LF	(O)/G/F/LF	G/LF
	IEC: 400 V/11 A UL: 300 V/10 A	IEC: 400 V/14 A UL: 300 V/10 A	IEC: 400 V/17 A UL: 300 V/10 A	IEC: 400 V/17 A UL: 300 V/10 A	IEC: 400 V/19 A UL: 300 V/15 A	IEC: 400 V/19 A UL: 300 V/15 A	IEC: 400 V/19 A UL: 300 V/15 A
	C.200	C.201	C.198	C.199	C.168	C.174	C.180
	○	○	○	○	○	○	○
			○	○	○	○	○
					○	○	○
	○	○			○	○	○
	○	○	○	○	○	○	○
	○	○	○	○	○	○	○
					○	○	○
					○	○	○
	●	●	●	●	●	●	●
	●	●	●	●	●	●	●

Male header and plug:

(O)* = open

B = Dovetail for fixing blocks with a nut

G = closed





F = Screw flange with nut

LF = Solder flange with nut

DF = Implementation

* not included in the article description

<http://www.OMNIMATE.net>

-  = Wire-to-Board
-  = Board-to-Board
-  = Wire-to-Wire
-  = Board-to-Wire

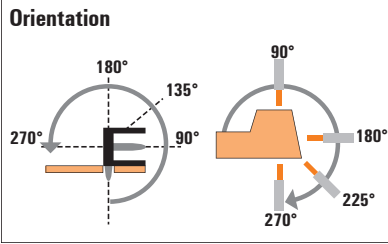

Male header



Reflow solder connection

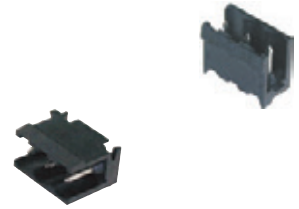

C

BL/SL 5.08 series Part 2 of 3



Type	Levels	
	1	
Orientation	90°	180°
Flange options Male headers	(0)	(0)
IEC / UL	IEC: 400 V/16.5 A UL: 300 V/15 A	IEC: 400 V/16.5 A UL: 300 V/15 A
Page	C.184	C.185



	Image	Type	Orientation	Options	IEC / UL	Page	Levels		
							1		
Female plug		BLZP	180°	(G)/F/LR	IEC: 400 V/19 A/0.2 - 4 mm ² UL: 300 V/10 A/AWG 26 - 12	C.218			
			90°	(G)/F/LR	IEC: 400 V/15.5 A/0.2 - 4 mm ² UL: 300 V/10 A/AWG 26 - 12	C.220			
			270°	(G)/F/LR	IEC: 400 V/15.5 A/0.2 - 4 mm ² UL: 300 V/10 A/AWG 26 - 12	C.222			
			225°	(G)/F/LR	IEC: 400 V/17.5 A/0.2 - 4 mm ² UL: 300 V/10 A/AWG 26 - 12	C.224			
Female plug		BLT	180°	(G)/F/LR/DF	IEC: 400 V/17 A/0.2 - 2.5 mm ² UL: 300 V/10 A/AWG 26 - 14	C.226			
			BLZ QV	180°	(G)	IEC: 400 V/17.5 A/0.2 - 2.5 mm ² UL: 300 V/15 A/AWG 26 - 14	C.228		
				BLDZ DN Devicenet	180°	(G)/F	IEC: 400 V/16 A/0.2 - 2.5 mm ² UL: 300 V/15 A/AWG 22 - 12	C.232	
Female plug		BLDT	180°	(G)	IEC: 400 V/14 A/0.2 - 2.5 mm ² UL: 300 V/10 A/AWG 26 - 12	C.234			
			Female header		BLL	90°	(G)/FI	IEC: 400 V/23 A UL: 300 V/15 A	C.246
180°	(G)/B	IEC: 400 V/23 A UL: 300 V/15 A				C.248			

Female plug and header:

- (G)* = Closed (without flange)
- F = Flange with screw
- DF = Implementation

- LR = Lock & Release lever
- B = Dovetail for fixing blocks with a nut
- FI = Inverted flange with nut

* not included in the article description

	Male plug		
	 Clamping yoke	 TOP	 PUSH IN

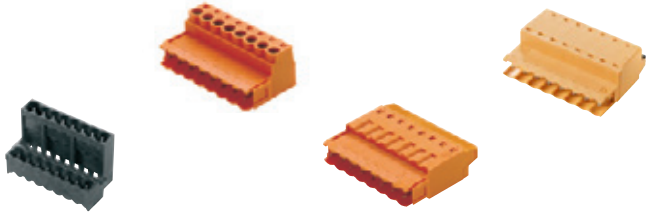

	2	1		1
	SLDV-THR	SLS	SLT	SLF
	180°	180°	180°	180°
	G/FLF	B/F/FI/DF	B/F/FI	B/F/FI/DF
	IEC: 400 V/15 A UL: 300 V/10 A	IEC: 400 V/21.5 A/ 0.2 - 2.5 mm ² UL: 300 V/15 A/ AWG 26 - 12	IEC: 400 V/16 A/ 0.2 - 2.5 mm ² UL: 300 V/10 A/ AWG 26 - 12	IEC: 400 V/21,5 A/ 0,2 - 2,5 mm ² UL: 300 V/15 A/ AWG 26 - 12
	C.186	C.210	C.214	C.216
	○	●	●	●
	○	●	●	●
		●	●	●
		●	●	●
	○	●	●	●
	○	●	●	●
		●	●	●
		●	●	●
	●	●	●	
	●	●	●	

Male header and plug:

(O)* = open

B = Dovetail for fixing blocks with a nut

G = closed

F = Screw flange with nut

LF = Solder flange with nut

DF = Implementation

* not included in the article description

<http://www.OMNIMATE.net>

○ = Wire-to-Board
 ● = Board-to-Board
 ○ = Wire-to-Wire
 ● = Board-to-Wire

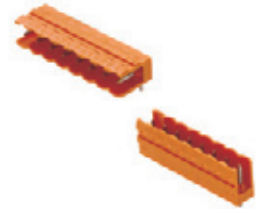
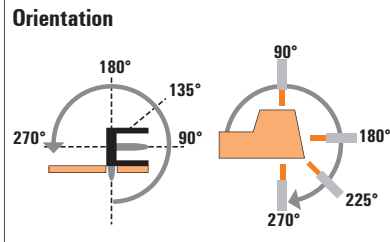

C

BL/SL 5.08 series Part 3 of 3



Type	Levels	
	1	
	SL HC	SL HC
	Orientation	90°
Flange options	(O)/G/B/F/LF	(O)/G/B/F/LF
IEC / UL	IEC: 400 V/24 A UL: 300 V/15 A	IEC: 400 V/24 A UL: 300 V/16 A
Page	C.190	C.194

Female plug	Type	Orientation	Flange options	IEC / UL	Page	Levels	
						SL HC	SL HC
PUSH IN	BLF	180°	(G)/F/LR/DF	IEC: 400 V/24 A/0.2 - 2.5 mm ² UL: 300 V/16 A/AWG 12 - AWG 26	C.236	○	○
	BLF	90°	(G)/F/LR	IEC: 400 V/24 A/0.2 - 2.5 mm ² UL: 300 V/16 A/AWG 12 - AWG 26	C.238	○	○
	BLF	270°	(G)/F/LR	IEC: 400 V/24 A/0.2 - 2.5 mm ² UL: 300 V/16 A/AWG 12 - AWG 26	C.240	○	○
PUSH IN (twin connector)	BLDF	180°	(G)/F/LR	IEC: 400 V/26.1 A/0.2 - 2.5 mm ² UL: 300 V/10 A/AWG 26-12	C.242	○	○
Crimp	BLC	180°	(G)/B	IEC: 400 V/21 A UL: 300 V/10 A	C.244	○	○

Female plug and header:
 (G)* = Closed (without flange)
 F = Flange with screw
 LR = Lock & Release lever

DF = Implementation
 B = Dovetail for fixing blocks with a nut

* not included in the article description

Male header								Male plug			
 <p>Solder connection</p>				 <p>Reflow solder connection</p>				 <p>PUSH IN</p>			

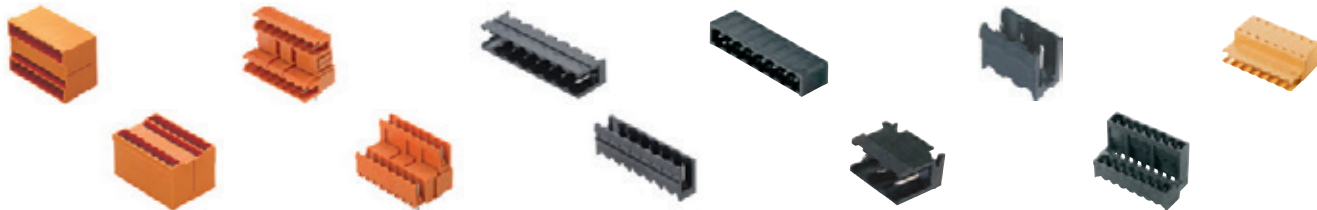

	2				1			1		2	1
	SLD	SLD	SLDV	SLDV	SL-SMT	SL-SMT	SL-SMT	SL-SMarT	SL-SMarT	SLDV-THR	SLF
	90°	180°	90°	180°	90°	180°	270°	90°	180°	180°	180°
	G	G	(O)/B	(O)/B	(O)/G/F/LF	(O)/G/F/LF	G/LF	(O)	(O)	G/FLF	B/F/FL/DF
	IEC: 400 V/11 A UL: 300 V/10 A	IEC: 400 V/14 A UL: 300 V/10 A	IEC: 400 V/17 A UL: 300 V/10 A	IEC: 400 V/17 A UL: 300 V/10 A	IEC: 400 V/19 A UL: 300 V/15 A	IEC: 400 V/19 A UL: 300 V/15 A	IEC: 400 V/19 A UL: 300 V/15 A	IEC: 400 V/16.5 A UL: 300 V/15 A	IEC: 400 V/16.5 A UL: 300 V/15 A	IEC: 400 V/15 A UL: 300 V/10 A	IEC: 400 V/21.5 A/ 0,2 - 2,5 mm ² UL: 300 V/15 A/ AWG 26 - 12
	C.200	C.201	C.198	C.199	C.168	C.174	C.180	C.184	C.185	C.186	C.208
	○	○	○	○	○	○	○	○	○	○	●
			○	○	○	○	○	○	○	○	●
					○	○	○	○	○		●
	○	○	○	○	○	○	○	○	○	○	●
	○	○	○	○	○	○	○	○	○	○	●

Male header and plug:

- (O)* = open
- B = Dovetail for fixing blocks with a nut
- G = closed

- F = Screw flange with nut
- LF = Solder flange with nut
- FLF = Flange with nut and additional solder flange

* not included in the article description

SL-SMT 5.08/./90

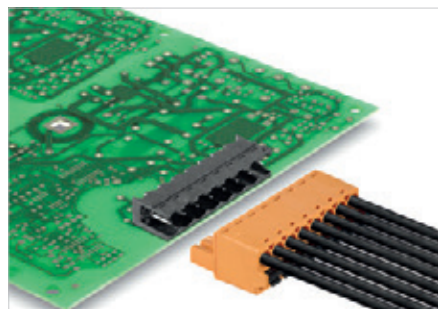

High-temperature-resistant, 90°-angled male header, optimised for SMT processing. The male headers can be manually coded or ordered as pre-coded headers.

- Available in open, closed (G), with screw flange (F) or with solder flange (LF).
- The solder flange substitutes a screw fastening to the PCB and protects the solder joints against mechanical stress.
- Available with 1.5 mm or 3.2 mm solder pins.
- The short 1.5 mm pins enable a double-sided PCB mounting and reduce the needed amount of solder paste without losing holding force to the PCB.
- Packed either in box (BX) or on anti-static roll (tape-on-reel, RL).

Technical data

In compliance with IEC 60664-1 / IEC 61984			
Clamping range, max.	mm ²		
Solid core H05(07) V-U	mm²		
Stranded H07 V-R			
Flexible H05(07) V-K	mm ²		
Flexible with ferrule	mm ²		
Ferrule with plastic collar	mm ²		
Stripping length	mm		
Screwdriver blade	mm		
According to norm			
Tightening torque range	Nm		
Rated current, max.	A	19	16
At ambient temperature		20°C	40°C
For conductor cross-section	mm ²		
Overvoltage category		III	III II
Pollution severity		3	2 2
Rated voltage	V	250	320 400
Rated impulse voltage	kV	4	4 4
UL / CUL (Use Group)		B	C D
Rated voltage	V	300	300
Rated current	A	15	10
AWG conductor	AWG		
CSA (Use Group)		B	C D
Rated voltage	V	300	300
Rated current	A	15	10
AWG conductor	AWG		
General data			
Type of insulation material		LCP GF	
UL 94 flammability rating		V-0	
Contact base material		CuSn	
Material of contact surface		tinned	
Pin dimensions = d	mm	1.2, Octagonal	
Solder eyelet Ø = D	mm	1.5	
Solder eyelet Ø tolerance	mm	+ 0,1	

Product data

IEC: 400 V / 19 A
UL: 300 V / 15 A

For additional articles and information, refer to catalog.weidmueller.com

Note:

- Gold-plated contact surfaces on request
- Rated current related to rated cross-section & min. No. of poles.
- Diameter of solder eyelet D = 1.4+0.1mm
- Diameter of solder eyelet D = 1.5+0.1mm from 9-pole
- P on drawing = pitch
- Rated data refer only to the component itself. Clearance and creepage distances to other components are to be designed in accordance with the relevant application standards.

SL-SMT 5.08/./90 Box

Packaged in box



Dimensioned drawing

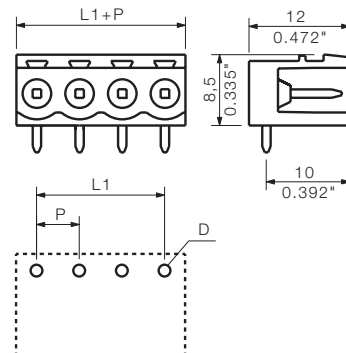

Accessories

Note: Refer to the Accessories chapter for additional accessories.

Coding		Order No.
	BLZ/SL KO OR	1573010000
	BLZ/SL KO SW	1545710000
Partition element		
	SL AT OR	1598300000
	SL AT SW	1770240000
LED light guide		
	SL FLA 1.5/1	1580100000
	SL FLA 1.5/24	1595850000
	SL FLA 2,3/1	1636670000
	SL FLA 2,3/24	1636680000
	SL FLA 3.8/1	1580110000
	SL FLA 3.8/24	1595860000
	SL FLA 9.0/1	1580120000
SL FLA 9.0/24	1595870000	

Ordering data

Solder pin length		1.5 mm	3.2 mm		
Colour		Black	Black		
Pitch 5.08 mm					
Pol.	L1 (inch)	Qty.	Order No.		
2	5.08	0.200	100	1774762001	1779950000
3	10.16	0.400	100	1774772001	1779960000
4	15.24	0.600	100	1774782001	1779970000
5	20.32	0.800	50	1774792001	1779980000
6	25.40	1.000	50	1774802001	1779990000
7	30.48	1.200	50	1774812001	1780000000
8	35.56	1.400	50	1774822001	1780010000
9	40.64	1.600	50	1774832001	1780020000
10	45.72	1.800	50	1774842001	1780030000
11	50.80	2.000	50	1774852001	1780040000
12	55.88	2.200	50	1774862001	1780050000
13	60.96	2.400	50	1774872001	1780060000
14	66.04	2.600	50	1774882001	1780070000
15	71.12	2.800	50	1774892001	1780080000
16	76.20	3.000	50	1774902001	1780090000
17	81.28	3.200	20	1774912001	1780100000
18	86.36	3.400	20	1774922001	1780110000
19	91.44	3.600	20	1774932001	1780120000
20	96.52	3.800	20	1774942001	1780130000
21	101.60	4.000	20	1774952001	1780140000
22	106.68	4.200	20	1774962001	1780150000
23	111.76	4.400	20	1774972001	1780160000
24	116.84	4.600	20	1774982001	1780170000

SL-SMT 5.08/./90 Tape

Tape-on-reel



Dimensioned drawing

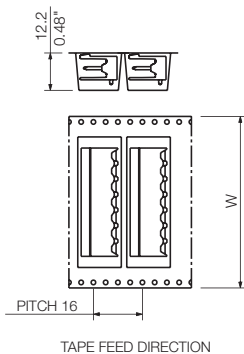

Ordering data

Solder pin length		1.5 mm		
Colour		Black		
Pitch 5.08 mm				
Pol.	L1	(inch)	Qty.	Order No.
2	5.08	0.200	350	1821160000
3	10.16	0.400	350	1821170000
4	15.24	0.600	350	1774784001
5	20.32	0.800	350	1774794001
6	25.40	1.000	350	1774804001
7	30.48	1.200	350	1774814001
8	35.56	1.400	350	1774824001

Tape widths: 32, 44, 56, 72, 88

SL-SMT 5.08/./90G Box

Packaged in box



Dimensioned drawing

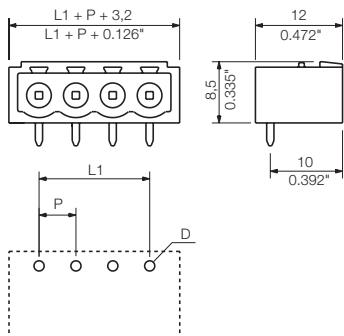

Ordering data

Solder pin length		1.5 mm		3.2 mm	
Colour		Black		Black	
Pitch 5.08 mm					
Pol.	L1	(inch)	Qty.	Order No.	Order No.
2	5.08	0.200	100	1775002001	1780180000
3	10.16	0.400	100	1775012001	1780190000
4	15.24	0.600	100	1775022001	1780200000
5	20.32	0.800	50	1775032001	1780210000
6	25.40	1.000	50	1775042001	1780220000
7	30.48	1.200	50	1775052001	1780230000
8	35.56	1.400	50	1775062001	1780240000
9	40.64	1.600	50	1775072001	1780250000
10	45.72	1.800	50	1775082001	1780260000
11	50.80	2.000	50	1775092001	1780270000
12	55.88	2.200	50	1775102001	1780280000
13	60.96	2.400	50	1775112001	1780290000
14	66.04	2.600	50	1775122001	1780300000
15	71.12	2.800	50	1775132001	1780310000
16	76.20	3.000	50	1775142001	1780320000
17	81.28	3.200	20	1775152001	1780330000
18	86.36	3.400	20	1775162001	1780340000
19	91.44	3.600	20	1775172001	1780350000
20	96.52	3.800	20	1775182001	1780360000
21	101.60	4.000	20	1775192001	1780370000
22	106.68	4.200	20	1775202001	1780380000
23	111.76	4.400	20	1775212001	1780390000
24	116.84	4.600	20	1775222001	1780400000

SL-SMT 5.08/./90G Tape

Tape-on-reel



Dimensioned drawing

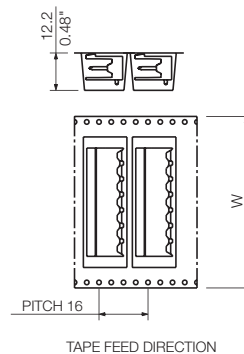

Ordering data

Solder pin length		1.5 mm		
Colour		Black		
Pitch 5.08 mm				
Pol.	L1	(inch)	Qty.	Order No.
2	5.08	0.200	350	1821140000
3	10.16	0.400	350	1775014001
4	15.24	0.600	350	1775024001
5	20.32	0.800	350	1775034001
6	25.40	1.000	350	1775044001
7	30.48	1.200	350	1775054001

Tape widths: 32, 44, 56, 72, 88

SL-SMT 5.08/./90

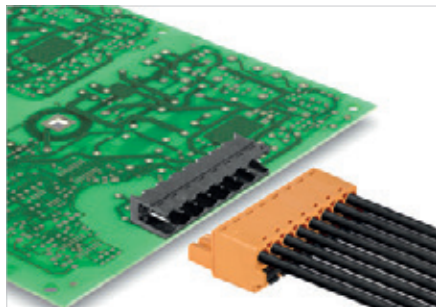

High-temperature-resistant, 90°-angled male header, optimised for SMT processing. The male headers can be manually coded or ordered as pre-coded headers.

- Available in open, closed (G), with screw flange (F) or with solder flange (LF).
- The solder flange substitutes a screw fastening to the PCB and protects the solder joints against mechanical stress.
- Available with 1.5 mm or 3.2 mm solder pins.
- The short 1.5 mm pins enable a double-sided PCB mounting and reduce the needed amount of solder paste without losing holding force to the PCB.
- Packed either in box (BX) or on anti-static roll (tape-on-reel, RL).

Technical data

In compliance with IEC 60664-1 / IEC 61984			
Clamping range, max.	mm ²		
Solid core H05(07) V-U	mm ²		
Stranded H07 V-R			
Flexible H05(07) V-K	mm ²		
Flexible with ferrule	mm ²		
Ferrule with plastic collar	mm ²		
Stripping length	mm		
Screwdriver blade	mm		
According to norm			
Tightening torque range	Nm		
Rated current, max.	A	19	16
At ambient temperature		20°C	40°C
For conductor cross-section	mm ²		
Overvoltage category		III	III II
Pollution severity		3	2 2
Rated voltage	V	250	320 400
Rated impulse voltage	kV	4	4 4
UL / CUL (Use Group)		B	C D
Rated voltage	V	300	300
Rated current	A	15	10
AWG conductor	AWG		
CSA (Use Group)		B	C D
Rated voltage	V	300	300
Rated current	A	15	10
AWG conductor	AWG		
General data			
Type of insulation material		LCP GF	
UL 94 flammability rating		V-0	
Contact base material		CuSn	
Material of contact surface		tinned	
Pin dimensions = d	mm	1.2, Octagonal	
Solder eyelet Ø = D	mm	1.5	
Solder eyelet Ø tolerance	mm	+ 0,1	

Product data

IEC: 400 V / 19 A
UL: 300 V / 15 A

For additional articles and information, refer to catalog.weidmueller.com

- Note:**
- Gold-plated contact surfaces on request
 - Rated current related to rated cross-section & min. No. of poles.
 - Diameter of solder eyelet D = 1.4+0.1mm
 - Diameter of solder eyelet D = 1.5+0.1mm from 9-pole
 - P on drawing = pitch
 - Rated data refer only to the component itself. Clearance and creepage distances to other components are to be designed in accordance with the relevant application standards.

SL-SMT 5.08/./90F Box

Packaged in box



Dimensioned drawing

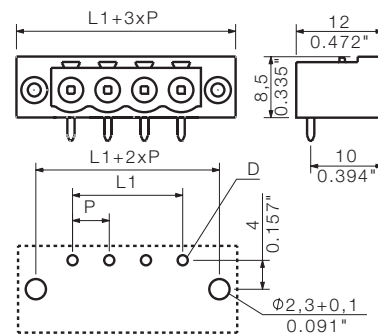

Accessories

Note: Refer to the Accessories chapter for additional accessories.

Coding		Order No.
	BLZ/SL KO OR	1573010000
	BLZ/SL KO SW	1545710000
Partition element		
	SL AT OR	1598300000
	SL AT SW	1770240000
LED light guide		
	SL FLA 1.5/1	1580100000
	SL FLA 1.5/24	1595850000
	SL FLA 2,3/1	1636670000
	SL FLA 2,3/24	1636680000
	SL FLA 3.8/1	1580110000
	SL FLA 3.8/24	1595860000
	SL FLA 9.0/1	1580120000
SL FLA 9.0/24	1595870000	

Ordering data

Solder pin length		3.2 mm		
Colour		Black		
Pitch 5.08 mm				
Pol.	L1 (inch)	Qty.	Order No.	
2	5.08	100	1837630000	
3	10.16	100	1837640000	
4	15.24	100	1837650000	
5	20.32	50	1837660000	
6	25.40	50	1837670000	
7	30.48	50	1837680000	
8	35.56	50	1837690000	
9	40.64	50	1837700000	
10	45.72	50	1837710000	
11	50.80	50	1837720000	
12	55.88	50	1837730000	
13	60.96	50	1837740000	
14	66.04	50	1837750000	
15	71.12	50	1837760000	
16	76.20	50	1837770000	
17	81.28	20	1837780000	
18	86.36	20	1837790000	
19	91.44	20	1837800000	
20	96.52	20	1837810000	
21	101.60	20	1837820000	
22	106.68	20	1837830000	
23	111.76	20	1837840000	
24	116.84	20	1837850000	

SL-SMT 5.08/./90

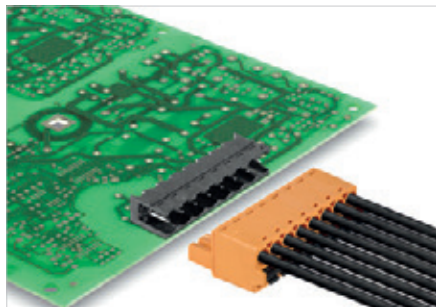

High-temperature-resistant, 90°-angled male header, optimised for SMT processing. The male headers can be manually coded or ordered as pre-coded headers.

- Available in open, closed (G), with screw flange (F) or with solder flange (LF).
- The solder flange substitutes a screw fastening to the PCB and protects the solder joints against mechanical stress.
- Available with 1.5 mm or 3.2 mm solder pins.
- The short 1.5 mm pins enable a double-sided PCB mounting and reduce the needed amount of solder paste without losing holding force to the PCB.
- Packed either in box (BX) or on anti-static roll (tape-on-reel, RL).

Technical data

In compliance with IEC 60664-1 / IEC 61984			
Clamping range, max.	mm ²		
Solid core H05(07) V-U	mm ²		
Stranded H07 V-R			
Flexible H05(07) V-K	mm ²		
Flexible with ferrule	mm ²		
Ferrule with plastic collar	mm ²		
Stripping length	mm		
Screwdriver blade	mm		
According to norm			
Tightening torque range	Nm		
Rated current, max.	A	19	16
At ambient temperature		20°C	40°C
For conductor cross-section	mm ²		
Overvoltage category		III	III II
Pollution severity		3	2 2
Rated voltage	V	250	320 400
Rated impulse voltage	kV	4	4 4
UL / CUL (Use Group)		B	C D
Rated voltage	V	300	300
Rated current	A	15	10
AWG conductor	AWG		
CSA (Use Group)		B	C D
Rated voltage	V	300	300
Rated current	A	15	10
AWG conductor	AWG		
General data			
Type of insulation material		LCP GF	
UL 94 flammability rating		V-0	
Contact base material		CuSn	
Material of contact surface		tinned	
Pin dimensions = d	mm	1.2, Octagonal	
Solder eyelet Ø = D	mm	1.5	
Solder eyelet Ø tolerance	mm	+ 0,1	

Product data

IEC: 400 V / 19 A
UL: 300 V / 15 A

For additional articles and information, refer to catalog.weidmuller.com

Note:

- Gold-plated contact surfaces on request
- Rated current related to rated cross-section & min. No. of poles.
- P on drawing = pitch
- Rated data refer only to the component itself. Clearance and creepage distances to other components are to be designed in accordance with the relevant application standards.

SL-SMT 5.08/./90LF Box

Packaged in box; with solder flange



Dimensioned drawing

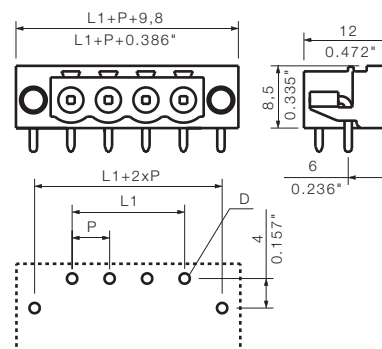

Accessories

Note: Refer to the Accessories chapter for additional accessories.

Coding		Order No.
	BLZ/SL KO OR	1573010000
	BLZ/SL KO SW	1545710000
Partition element		
	SL AT OR	1598300000
	SL AT SW	1770240000
LED light guide		
	SL FLA 1.5/1	1580100000
	SL FLA 1.5/24	1595850000
	SL FLA 2,3/1	1636670000
	SL FLA 2,3/24	1636680000
	SL FLA 3.8/1	1580110000
	SL FLA 3.8/24	1595860000
	SL FLA 9.0/1	1580120000
	SL FLA 9.0/24	1595870000

Ordering data

Solder pin length		1.5 mm	3.2 mm		
Colour		Black	Black		
Pitch 5.08 mm					
Pol.	L1	(inch)	Qty.	Order No.	Order No.
2	5.08	0.200	100	1775232001	1780410000
3	10.16	0.400	100	1775242001	1780420000
4	15.24	0.600	100	1775252001	1780430000
5	20.32	0.800	50	1775262001	1780440000
6	25.40	1.000	50	1775272001	1780450000
7	30.48	1.200	50	1775282001	1780460000
8	35.56	1.400	50	1775292001	1780470000
9	40.64	1.600	50	1775302001	1780480000
10	45.72	1.800	50	1775312001	1780490000
11	50.80	2.000	50	1775322001	1780500000
12	55.88	2.200	50	1775332001	1780510000
13	60.96	2.400	50	1775342001	1780520000
14	66.04	2.600	50	1775352001	1780530000
15	71.12	2.800	50	1775362001	1780540000
16	76.20	3.000	50	1775372001	1780550000
17	81.28	3.200	20	1775382001	1780560000
18	86.36	3.400	20	1775392001	1780570000
19	91.44	3.600	20	1775402001	1780580000
20	96.52	3.800	20	1775412001	1780590000
21	101.60	4.000	20	1775422001	1780600000
22	106.68	4.200	20	1775432001	1780610000
23	111.76	4.400	20	1775442001	1780620000
24	116.84	4.600	20	1775452001	1780630000

SL-SMT 5.08/./90LF Tape

Tape-on-reel; with solder flange



Dimensioned drawing

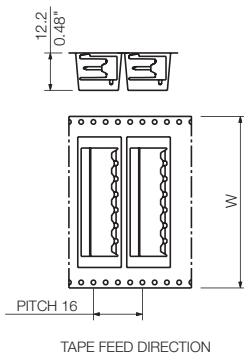

Solder flange (LF)

Normally you use a pin header with fastening flanges (F) in combination with a screw from the rear side of the PCB to increase the fixation forces of the pin headers. The disadvantages are additional process steps that make the PCB mounting complex and cost intensive. The patented solder flange was designed to solve exactly this problem and find a simple and cheap solution. The additional solder pins substitute the present screw flanges and they get soldered together with the pin header. This terminates additional process steps and thus reduces production costs. The additional fixation protects the soldered connections from tensile strain and avoids permanent mechanical stress such as caused by the post-fastened screw forces.

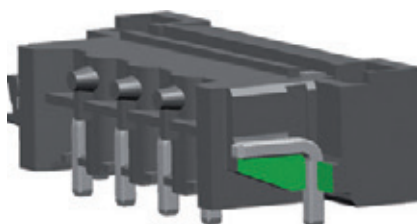

Ordering data

Solder pin length		1.5 mm		
Colour		Black		
Pitch		5.08 mm		
Pol.	L1	(inch)	Qty.	Order No.
2	5.08	0.200	350	1775234001
3	10.16	0.400	350	1775244001
4	15.24	0.600	350	1775254001
5	20.32	0.800	350	1775264001
6	25.40	1.000	350	1775274001

Tape widths: 32, 44, 56, 72, 88

SL-SMT 5.08/./180

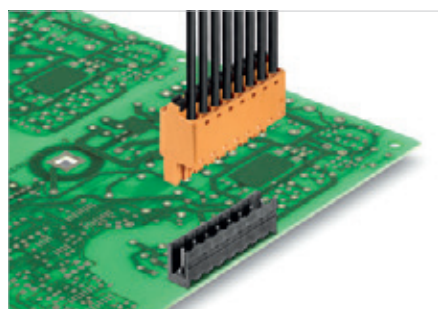

High-temperature-resistant, 180°-angled male header, optimised for SMT processing. The male headers can be manually coded or ordered as pre-coded headers.

- Available in open, closed (G), with screw flange (F) or with solder flange (LF).
- The solder flange substitutes a screw fastening to the PCB and protects the solder joints against mechanical stress.
- Available with 1.5 mm or 3.2 mm solder pins.
- The short 1.5 mm pins enable a double-sided PCB mounting and reduce the needed amount of solder paste without losing holding force to the PCB.
- Packed either in box (BX) or on anti-static roll (tape-on-reel, RL).

Technical data

In compliance with IEC 60664-1 / IEC 61984			
Clamping range, max.	mm ²		
Solid core H05(07) V-U	mm ²		
Stranded H07 V-R			
Flexible H05(07) V-K	mm ²		
Flexible with ferrule	mm ²		
Ferrule with plastic collar	mm ²		
Stripping length	mm		
Screwdriver blade	mm		
According to norm			
Tightening torque range	Nm		
Rated current, max.	A	19	16
At ambient temperature		20°C	40°C
For conductor cross-section	mm ²		
Overvoltage category		III	III II
Pollution severity		3	2 2
Rated voltage	V	250	320 400
Rated impulse voltage	kV	4	4 4
UL / CUL (Use Group)		B	C D
Rated voltage	V	300	300
Rated current	A	15	10
AWG conductor	AWG		
CSA (Use Group)		B	C D
Rated voltage	V	300	300
Rated current	A	15	10
AWG conductor	AWG		
General data			
Type of insulation material		LCP GF	
UL 94 flammability rating		V-0	
Contact base material		CuSn	
Material of contact surface		tinned	
Pin dimensions = d	mm	1.2, Octagonal	
Solder eyelet Ø = D	mm	1.5	
Solder eyelet Ø tolerance	mm	+ 0,1	

Product data

IEC: 400 V / 19 A
UL: 300 V / 15 A

For additional articles and information, refer to catalog.weidmueller.com

Note:

- Gold-plated contact surfaces on request
- Rated current related to rated cross-section & min. No. of poles.
- Diameter of solder eyelet D = 1.4+0.1mm
- Diameter of solder eyelet D = 1.5+0.1mm from 9-pole
- P on drawing = pitch
- Rated data refer only to the component itself. Clearance and creepage distances to other components are to be designed in accordance with the relevant application standards.

SL-SMT 5.08/./180 Box

Packaged in box



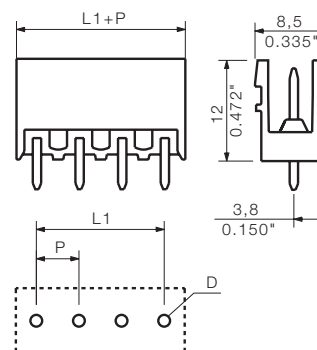

Dimensioned drawing



Accessories

Note: Refer to the Accessories chapter for additional accessories.

Coding		Order No.
	BLZ/SL KO OR	1573010000
	BLZ/SL KO SW	1545710000
Partition element		
	SL AT OR	1598300000
	SL AT SW	1770240000

Ordering data

Solder pin length		1.5 mm	3.2 mm		
Colour		Black	Black		
Pitch 5.08 mm					
Pol.	L1	(inch)	Qty.	Order No.	Order No.
2	5.08	0.200	100	1775522001	1837980000
3	10.16	0.400	100	1775572001	1837990000
4	15.24	0.600	100	1775592001	1838000000
5	20.32	0.800	50	1775632001	1838010000
6	25.40	1.000	50	1775642001	1838020000
7	30.48	1.200	50	1775652001	1838030000
8	35.56	1.400	50	1775662001	1838040000
9	40.64	1.600	50	1775672001	1838050000
10	45.72	1.800	50	1775682001	1838060000
11	50.80	2.000	50	1775692001	1838070000
12	55.88	2.200	50	1775702001	1838080000
13	60.96	2.400	50	1775712001	1838090000
14	66.04	2.600	50	1775722001	1838100000
15	71.12	2.800	50	1775732001	1838110000
16	76.20	3.000	50	1775742001	1838120000
17	81.28	3.200	20	1775752001	1838130000
18	86.36	3.400	20	1775762001	1838140000
19	91.44	3.600	20	1775772001	1838150000
20	96.52	3.800	20	1775782001	1838160000
21	101.60	4.000	20	1775792001	1838170000
22	106.68	4.200	20	1775802001	1838180000
23	111.76	4.400	20	1775812001	1838190000
24	116.84	4.600	20	1775822001	1838200000

SL-SMT 5.08../180 Tape

Tape-on-reel



Dimensioned drawing

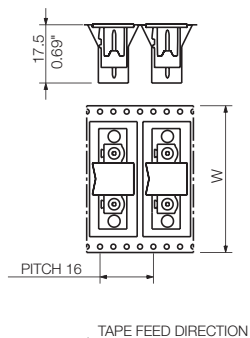

Ordering data

Solder pin length		1.5 mm		
Colour		Black		
Pitch		5.08 mm		
Pol.	L1	(inch)	Qty.	Order No.
2	5.08	0.200	250	1821100000
3	10.16	0.400	250	1821110000
4	15.24	0.600	250	1775594001
5	20.32	0.800	250	1775634001
6	25.40	1.000	250	1775644001
7	30.48	1.200	250	1775654001
8	35.56	1.400	250	1775664001

Tape widths: 32, 44, 56, 72, 88

SL-SMT 5.08../180G Box

Packaged in box



Dimensioned drawing

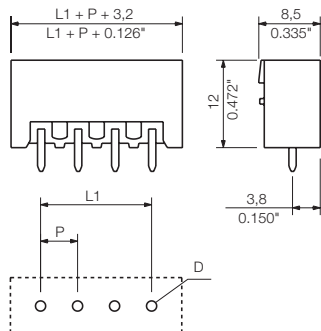

Ordering data

Solder pin length		1.5 mm		3.2 mm	
Colour		Black		Black	
Pitch		5.08 mm			
Pol.	L1	(inch)	Qty.	Order No.	Order No.
2	5.08	0.200	100	1775922001	1838210000
3	10.16	0.400	100	1775932001	1838220000
4	15.24	0.600	100	1775942001	1838230000
5	20.32	0.800	50	1775952001	1838240000
6	25.40	1.000	50	1775962001	1838250000
7	30.48	1.200	50	1775972001	1838260000
8	35.56	1.400	50	1775982001	1838270000
9	40.64	1.600	50	1775992001	1838280000
10	45.72	1.800	50	1776002001	1838290000
11	50.80	2.000	50	1776012001	1838300000
12	55.88	2.200	50	1776022001	1838310000
13	60.96	2.400	50	1776242001	1838320000
14	66.04	2.600	50	1776252001	1838330000
15	71.12	2.800	50	1776262001	1838340000
16	76.20	3.000	50	1776272001	1838350000
17	81.28	3.200	20	1776282001	1838360000
18	86.36	3.400	20	1776292001	1838370000
19	91.44	3.600	20	1776302001	1838380000
20	96.52	3.800	20	1776312001	1838390000
21	101.60	4.000	20	1776322001	1838400000
22	106.68	4.200	20	1776332001	1838410000
23	111.76	4.400	20	1776342001	1838420000
24	116.84	4.600	20	1776352001	1838430000

SL-SMT 5.08../180G Tape

Tape-on-reel



Dimensioned drawing

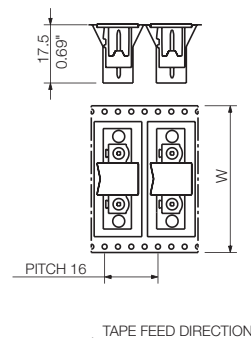

Ordering data

Solder pin length		1.5 mm		
Colour		Black		
Pitch		5.08 mm		
Pol.	L1	(inch)	Qty.	Order No.
2	5.08	0.200	250	1820170000
3	10.16	0.400	250	1775934001
4	15.24	0.600	250	1775944001
5	20.32	0.800	250	1775954001
6	25.40	1.000	250	1775964001
7	30.48	1.200	250	1775974001

Tape widths: 32, 44, 56, 72, 88

SL-SMT 5.08/./180

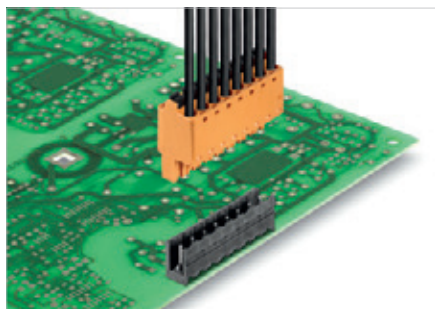

High-temperature-resistant, 180°-angled male header, optimised for SMT processing. The male headers can be manually coded or ordered as pre-coded headers.

- Available in open, closed (G), with screw flange (F) or with solder flange (LF).
- The solder flange substitutes a screw fastening to the PCB and protects the solder joints against mechanical stress.
- Available with 1.5 mm or 3.2 mm solder pins.
- The short 1.5 mm pins enable a double-sided PCB mounting and reduce the needed amount of solder paste without losing holding force to the PCB.
- Packed either in box (BX) or on anti-static roll (tape-on-reel, RL).

Technical data

In compliance with IEC 60664-1 / IEC 61984			
Clamping range, max.	mm ²		
Solid core H05(07) V-U	mm²		
Stranded H07 V-R			
Flexible H05(07) V-K	mm ²		
Flexible with ferrule	mm ²		
Ferrule with plastic collar	mm ²		
Stripping length	mm		
Screwdriver blade	mm		
According to norm			
Tightening torque range	Nm		
Rated current, max.	A	19	16
At ambient temperature		20°C	40°C
For conductor cross-section	mm ²		
Overvoltage category		III	III II
Pollution severity		3	2 2
Rated voltage	V	250	320 400
Rated impulse voltage	kV	4	4 4
UL / CUL (Use Group)		B	C D
Rated voltage	V	300	300
Rated current	A	15	10
AWG conductor	AWG		
CSA (Use Group)		B	C D
Rated voltage	V	300	300
Rated current	A	15	10
AWG conductor	AWG		
General data			
Type of insulation material		LCP GF	
UL 94 flammability rating		V-0	
Contact base material		CuSn	
Material of contact surface			
Pin dimensions = d	mm	1.2, Octagonal	
Solder eyelet Ø = D	mm	1.5	
Solder eyelet Ø tolerance	mm	+ 0,1	

Product data

IEC: 400 V / 19 A
UL: 300 V / 15 A

For additional articles and information, refer to catalog.weidmueller.com

Note:

- Gold-plated contact surfaces on request
- Rated current related to rated cross-section & min. No. of poles.
- Diameter of solder eyelet D = 1.4+0.1mm
- Diameter of solder eyelet D = 1.5+0.1mm from 9-pole
- P on drawing = pitch
- Rated data refer only to the component itself. Clearance and creepage distances to other components are to be designed in accordance with the relevant application standards.

SL-SMT 5.08/./180F Box

Packaged in box



Dimensioned drawing

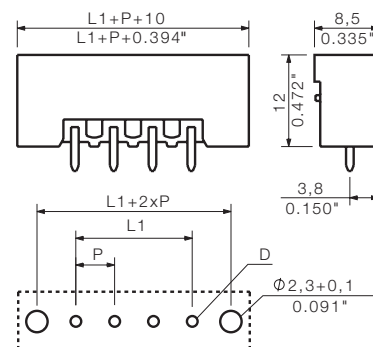

Accessories

Note: Refer to the Accessories chapter for additional accessories.

Coding		Order No.
	BLZ/SL KO OR	1573010000
	BLZ/SL KO SW	1545710000
Partition element		
	SL AT OR	1598300000
	SL AT SW	1770240000

Ordering data

Solder pin length		1.5 mm	3.2 mm		
Colour		Black	Black		
Pitch 5.08 mm					
Pol.	L1	(inch)	Qty.	Order No.	Order No.
2	5.08	0.200	100	1837320000	1837860000
3	10.16	0.400	100		1820600000
4	15.24	0.600	100	1830100000	1837870000
5	20.32	0.800	50	1837330000	1820770000
6	25.40	1.000	50	1837340000	1820610000
7	30.48	1.200	50		1837880000
8	35.55	1.400	50		1820620000
9	40.64	1.600	50	1880940000	1837890000
10	45.72	1.800	50	1880950000	1820780000
11	50.80	2.000	50	1880960000	1837900000
12	55.88	2.200	50	1880970000	1820630000
13	60.96	2.400	50	1879920000	1820790000
14	66.04	2.600	50		1820800000
15	71.12	2.800	50		1837910000
16	76.20	3.000	50		1820640000
17	81.28	3.200	20		1837920000
18	86.36	3.400	20		1820650000
19	91.44	3.600	20		1837930000
20	96.52	3.800	20		1820810000
21	101.60	4.000	20		1837940000
22	106.68	4.200	20		1837950000
23	111.76	4.400	20		1837960000
24	116.84	4.600	20		1837970000

SL-SMT 5.08/./180

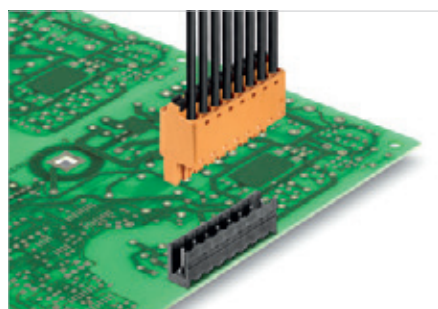

High-temperature-resistant, 180°-angled male header, optimised for SMT processing. The male headers can be manually coded or ordered as pre-coded headers.

- Available in open, closed (G), with screw flange (F) or with solder Flange (LF).
- The solder flange substitutes a screw fastening to the PCB and protects the solder joints against mechanical stress.
- Available with 1.5 mm or 3.2 mm solder pins.
- The short 1.5 mm pins enable a double-sided PCB mounting and reduce the needed amount of solder paste without losing holding force to the PCB.
- Packed either in box (BX) or on anti-static roll (tape-on-reel, RL).

Technical data

In compliance with IEC 60664-1 / IEC 61984			
Clamping range, max.	mm ²		
Solid core H05(07) V-U	mm ²		
Stranded H07 V-R			
Flexible H05(07) V-K	mm ²		
Flexible with ferrule	mm ²		
Ferrule with plastic collar	mm ²		
Stripping length	mm		
Screwdriver blade	mm		
According to norm			
Tightening torque range	Nm		
Rated current, max.	A	19	16
At ambient temperature		20°C	40°C
For conductor cross-section	mm ²		
Overtolerance category		III	III II
Pollution severity		3	2 2
Rated voltage	V	250	320 400
Rated impulse voltage	kV	4	4 4
UL / CUL (Use Group)		B	C D
Rated voltage	V	300	300
Rated current	A	15	10
AWG conductor	AWG		
CSA (Use Group)		B	C D
Rated voltage	V	300	300
Rated current	A	15	10
AWG conductor	AWG		
General data			
Type of insulation material		LCP GF	
UL 94 flammability rating		V-0	
Contact base material		CuSn	
Material of contact surface		tinned	
Pin dimensions = d	mm	1.2, Octagonal	
Solder eyelet Ø = D	mm	1.5	
Solder eyelet Ø tolerance	mm	+ 0,1	

Product data

IEC: 400 V / 19 A
UL: 300 V / 15 A

For additional articles and information, refer to catalog.weidmueller.com

Note:

- Gold-plated contact surfaces on request
- Rated current related to rated cross-section & min. No. of poles.
- Diameter of solder eyelet D = 1.4+0.1mm
- Diameter of solder eyelet D = 1.5+0.1mm from 9-pole
- P on drawing = pitch
- Rated data refer only to the component itself. Clearance and creepage distances to other components are to be designed in accordance with the relevant application standards.

SL-SMT 5.08/./180LF Box

Packaged in box; with solder flange



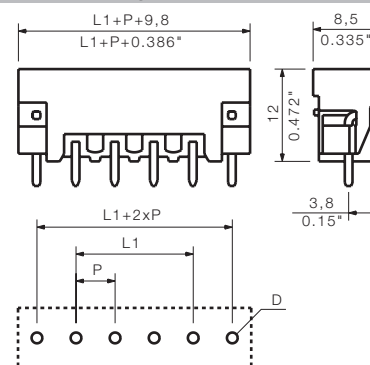

Dimensioned drawing



Accessories

Note: Refer to the Accessories chapter for additional accessories.

Coding		Order No.
	BLZ/SL KO OR	1573010000
	BLZ/SL KO SW	1545710000
Partition element		
	SL AT OR	1598300000
	SL AT SW	1770240000

Ordering data

Solder pin length		1.5 mm	3.2 mm		
Colour		Black	Black		
Pitch 5.08 mm					
Pol.	L1	(inch)	Qty.	Order No.	Order No.
2	5.08	0.200	100	1776362001	1838440000
3	10.16	0.400	100	1776372001	1838450000
4	15.24	0.600	100	1776382001	1838460000
5	20.32	0.800	50	1776392001	1838470000
6	25.40	1.000	50	1776402001	1838480000
7	30.48	1.200	50	1776412001	1838490000
8	35.56	1.400	50	1776422001	1838500000
9	40.64	1.600	50	1776432001	1838510000
10	45.72	1.800	50	1776442001	1838520000
11	50.80	2.000	50	1776452001	1838530000
12	55.88	2.200	50	1776462001	1838540000
13	60.96	2.400	50	1776472001	1838550000
14	66.04	2.600	50	1776482001	1838560000
15	71.12	2.800	50	1776492001	1838570000
16	76.20	3.000	50	1776502001	1838580000
17	81.28	3.200	20	1776512001	1838590000
18	86.36	3.400	20	1776522001	1838600000
19	91.44	3.600	20	1776532001	1838610000
20	96.52	3.800	20	1776542001	1838620000
21	101.60	4.000	20	1776552001	1838630000
22	106.68	4.200	20	1776562001	1838640000
23	111.76	4.400	20	1776572001	1838650000
24	116.84	4.600	20	1776582001	1838660000

SL-SMT 5.08/./180LF Tape

Packaged in box; with solder flange



Dimensioned drawing

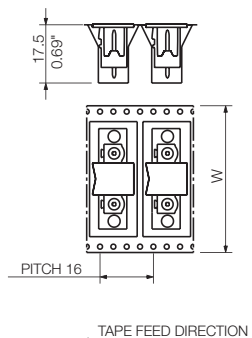

Solder flange (LF)

Normally you use a pin header with fastening flanges (F) in combination with a screw from the rear side of the PCB to increase the fixation forces of the pin headers. The disadvantages are additional process steps that make the PCB mounting complex and cost intensive. The patented solder flange was designed to solve exactly this problem and find a simple and cheap solution. The additional solder pins substitute the present screw flanges and they get soldered together with the pin header. This terminates additional process steps and thus reduces production costs. The additional fixation protects the soldered connections from tensile strain and avoids permanent mechanical stress such as caused by the post-fastened screw forces.

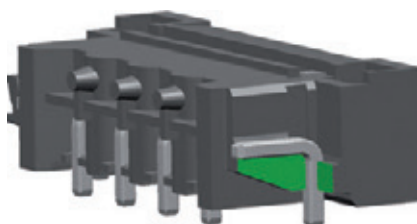

Ordering data

Solder pin length		1.5 mm		
Colour		Black		
Pitch		5.08 mm		
Pol.	L1	(inch)	Qty.	Order No.
2	5.08	0.200	250	1776364001
3	10.16	0.400	250	1776374001
4	15.24	0.600	250	1776384001
5	20.32	0.800	250	1776394001
6	25.40	1.000	250	1776404001

Tape widths: 32, 44, 56, 72, 88

SL-SMT 5.08/./270

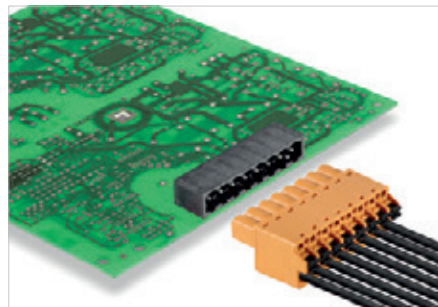

High-temperature-resistant, 270°-angled male header, optimised for SMT processing. The male headers can be manually coded or ordered as pre-coded headers.

- Available in open, closed (G), with screw flange (F) or with solder flange (LF).
- The solder flange substitutes a screw fastening to the PCB and protects the solder joints against mechanical stress.
- Available with 1.5 mm or 3.2 mm solder pins.
- The short 1.5 mm pins enable a double-sided PCB mounting and reduce the needed amount of solder paste without losing holding force to the PCB.
- Packed either in box (BX) or on anti-static roll (tape-on-reel, RL).

Technical data

In compliance with IEC 60664-1 / IEC 61984			
Clamping range, max.	mm ²		
Solid core H05(07) V-U	mm²		
Stranded H07 V-R			
Flexible H05(07) V-K	mm ²		
Flexible with ferrule	mm ²		
Ferrule with plastic collar	mm ²		
Stripping length	mm		
Screwdriver blade	mm		
According to norm			
Tightening torque range	Nm		
Rated current, max.	A	19	16
At ambient temperature		20°C	40°C
For conductor cross-section	mm ²		
Overvoltage category		III	III II
Pollution severity		3	2 2
Rated voltage	V	250	320 400
Rated impulse voltage	kV	4	4 4
UL / CUL (Use Group)	B C D		
Rated voltage	V	300	300
Rated current	A	15	10
AWG conductor	AWG		
CSA (Use Group)	B C D		
Rated voltage	V	300	300
Rated current	A	15	10
AWG conductor	AWG		
General data			
Type of insulation material		LCP GF	
UL 94 flammability rating		V-0	
Contact base material		CuSn	
Material of contact surface		tinned	
Pin dimensions = d	mm	1.2, Octagonal	
Solder eyelet Ø = D	mm	1.4	
Solder eyelet Ø tolerance	mm	+ 0,1	

Product data

IEC: 400 V / 19 A
UL: 300 V / 15 A

For additional articles and information, refer to catalog.weidmueller.com

Note:

- Gold-plated contact surfaces on request
- Rated current related to rated cross-section & min. No. of poles.
- P on drawing = pitch
- Rated data refer only to the component itself. Clearance and creepage distances to other components are to be designed in accordance with the relevant application standards.

SL-SMT 5.08/./270GL Box

Packaged in box



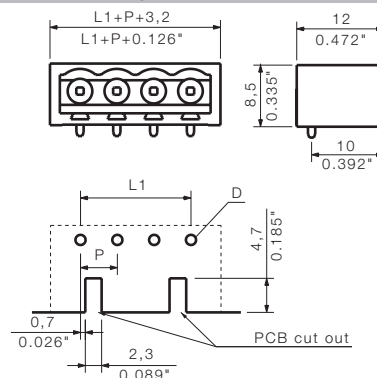

Dimensioned drawing



Accessories

Note: Refer to the Accessories chapter for additional accessories.

Coding		Order No.
	BLZ/SL KO OR	1573010000
	BLZ/SL KO SW	1545710000
Partition element		
	SL AT OR	1598300000
	SL AT SW	1770240000

Ordering data

Solder pin length		1.5 mm	3.2 mm
Colour		Black	Black
Pitch 5.08 mm			
Pol.	L1 (inch)	Qty.	Order No.
2	5.08 0.200	100	1877100000 1877470000
3	10.16 0.400	100	1877130000 1877490000
4	15.24 0.600	100	1877140000 1877510000
5	20.32 0.800	50	1877150000 1877520000
6	25.40 1.000	50	1877160000 1877530000
7	30.48 1.200	50	1877170000 1877540000
8	35.56 1.400	50	1877180000 1877550000

SL-SMT 5.08/./270GL Tape

Tape-on-reel



Dimensioned drawing

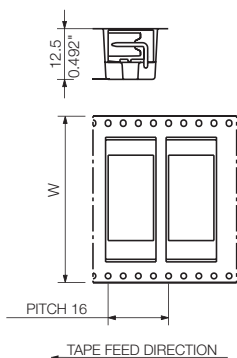

Ordering data

Solder pin length		1.5 mm			
Colour		Black			
Pitch		5.08 mm			
Pol.	L1	(inch)	Qty.	Order No.	
2	5.08	0.200	350	1877740000	
3	10.16	0.400	350	1877750000	
4	15.24	0.600	350	1877760000	
5	20.32	0.800	350	1877770000	
6	25.40	1.000	350	1877780000	
7	30.48	1.200	350	1877790000	
8	35.56	1.400	350	1877800000	

Tape widths: 32, 44, 56, 72, 88

SL-SMT 5.08/./270GH Box

Packaged in box



Dimensioned drawing

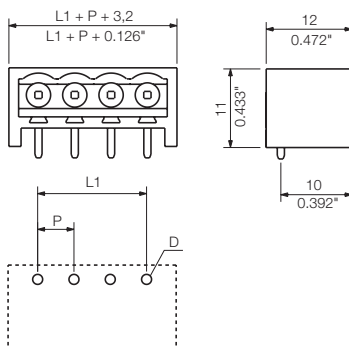

Ordering data

Solder pin length		1.5 mm		3.2 mm	
Colour		Black		Black	
Pitch		5.08 mm			
Pol.	L1	(inch)	Qty.	Order No.	
2	5.08	0.200	100	1876340000	1877370000
3	10.16	0.400	100	1877010000	1877380000
4	15.24	0.600	100	1877030000	1877390000
5	20.32	0.800	50	1877040000	1877400000
6	25.40	1.000	50	1877050000	1877410000
7	30.48	1.200	50	1877060000	1877420000
8	35.56	1.400	50	1877080000	1877450000

SL-SMT 5.08/./270GH Tape

Tape-on-reel



Dimensioned drawing

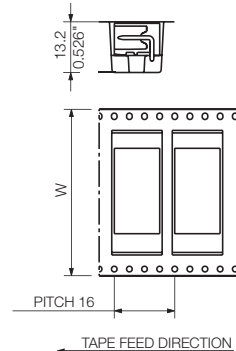

Ordering data

Solder pin length		1.5 mm			
Colour		Black			
Pitch		5.08 mm			
Pol.	L1	(inch)	Qty.	Order No.	
2	5.08	0.200	335	1877560000	
3	10.16	0.400	335	1877600000	
4	15.24	0.600	335	1877610000	
5	20.32	0.800	335	1877620000	
6	25.40	1.000	265	1877630000	
7	30.48	1.200	335	1877640000	
8	35.56	1.400	285	1877650000	

Tape widths: 32, 44, 56, 72, 88

SL-SMT 5.08/./270

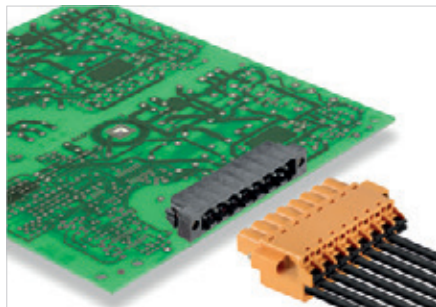

High-temperature-resistant, 270°-angled male header, optimised for SMT processing. The male headers can be manually coded or ordered as pre-coded headers.

- Available in open, closed (G), with screw flange (F) or with solder Flange (LF).
- The solder flange substitutes a screw fastening to the PCB and protects the solder joints against mechanical stress.
- Available with 1.5 mm or 3.2 mm solder pins.
- The short 1.5 mm pins enable a double-sided PCB mounting and reduce the needed amount of solder paste without losing holding force to the PCB.
- Packed either in box (BX) or on anti-static roll (tape-on-reel, RL).

Technical data

In compliance with IEC 60664-1 / IEC 61984			
Clamping range, max.	mm ²		
Solid core H05(07) V-U	mm²		
Stranded H07 V-R			
Flexible H05(07) V-K	mm ²		
Flexible with ferrule	mm ²		
Ferrule with plastic collar	mm ²		
Stripping length	mm		
Screwdriver blade	mm		
According to norm			
Tightening torque range	Nm		
Rated current, max.	A	19	16
At ambient temperature		20°C	40°C
For conductor cross-section	mm ²		
Overvoltage category		III	III II
Pollution severity		3	2 2
Rated voltage	V	250	320 400
Rated impulse voltage	kV	4	4 4
UL / CUL (Use Group)	B C D		
Rated voltage	V	300	300
Rated current	A	15	10
AWG conductor	AWG		
CSA (Use Group)	B C D		
Rated voltage	V	300	300
Rated current	A	15	10
AWG conductor	AWG		
General data			
Type of insulation material		LCP GF	
UL 94 flammability rating		V-0	
Contact base material		CuSn	
Material of contact surface		tinned	
Pin dimensions = d	mm	1.2, Octagonal	
Solder eyelet Ø = D	mm	1.4	
Solder eyelet Ø tolerance	mm	+ 0,1	

Product data

IEC: 400 V / 19 A
UL: 300 V / 15 A

For additional articles and information, refer to catalog.weidmueller.com

Note:

- Gold-plated contact surfaces on request
- Rated current related to rated cross-section & min. No. of poles.
- P on drawing = pitch
- Rated data refer only to the component itself. Clearance and creepage distances to other components are to be designed in accordance with the relevant application standards.

SL-SMT 5.08/./270FL Box

Packaged in box; with solder flange



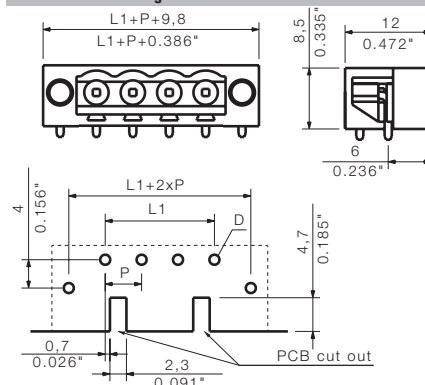

Dimensioned drawing



Accessories

Note: Refer to the Accessories chapter for additional accessories.

Coding		Order No.
	BLZ/SL KO OR	1573010000
	BLZ/SL KO SW	1545710000
Partition element		
	SL AT OR	1598300000
	SL AT SW	1770240000

Ordering data

Solder pin length	1.5 mm		3.2 mm		
	Black		Black		
Pitch	5.08 mm				
Pol.	L1	(inch)	Qty.	Order No.	Order No.
2	5.08	0.200	100	1878090000	1876850000
3	10.16	0.400	100	1878110000	1876860000
4	15.24	0.600	100	1878120000	1876870000
5	20.32	0.800	50	1878130000	1876880000
6	25.40	1.000	50	1878140000	1876890000
7	30.48	1.200	50	1878150000	1876900000
8	35.56	1.400	50	1878160000	1876910000

SL-SMT 5.08/./270FL Tape

Tape-on-reel; with solder flange



Dimensioned drawing

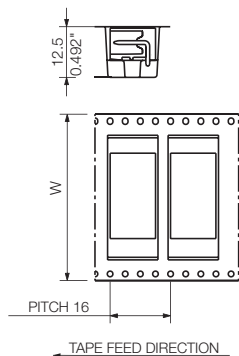

Ordering data

Solder pin length		1.5 mm			
Colour		Black			
Pitch		5.08 mm			
Pol.	L1	(inch)	Qty.	Order No.	
2	5.08	0.200	350	1876990000	
3	10.16	0.400	350	1877000000	
4	15.24	0.600	350	1877020000	
5	20.32	0.800	350	1877070000	
6	25.40	1.000	350	1877090000	
7	30.48	1.200	300	1877110000	
8	35.56	1.400	300	1877120000	

Tape widths: 32, 44, 56, 72, 88

SL-SMT 5.08/./270FH Box

Packaged in box; with solder flange



Dimensioned drawing

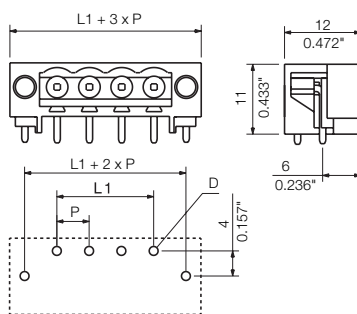

Ordering data

Solder pin length		1.5 mm		3.2 mm	
Colour		Black		Black	
Pitch		5.08 mm			
Pol.	L1	(inch)	Qty.	Order No.	Order No.
2	5.08	0.200	100	1877960000	1877190000
3	10.16	0.400	100	1877970000	1877210000
4	15.24	0.600	100	1877980000	1877330000
5	20.32	0.800	50	1877990000	1877430000
6	25.40	1.000	50	1878000000	1877460000
7	30.48	1.200	50	1878010000	1877480000
8	35.56	1.400	50	1878020000	1877500000

SL-SMT 5.08/./270FH Tape

Tape-on-reel; with solder flange



Dimensioned drawing

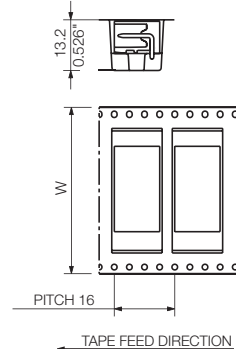

Ordering data

Solder pin length		1.5 mm			
Colour		Black			
Pitch		5.08 mm			
Pol.	L1	(inch)	Qty.	Order No.	
2	5.08	0.200	335	1876920000	
3	10.16	0.400	335	1876930000	
4	15.24	0.600	335	1876940000	
5	20.32	0.800	335	1876950000	
6	25.40	1.000	335	1876960000	
7	30.48	1.200	285	1876970000	
8	35.56	1.400	285	1876980000	

Tape widths: 32, 44, 56, 72, 88

SL-SMaRT 5.0x/./90 & 180

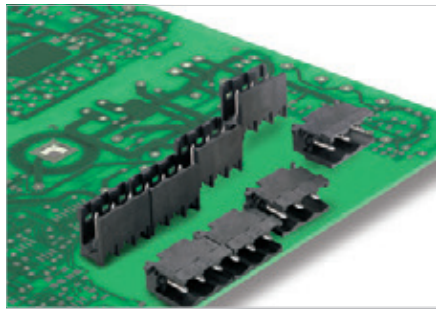

High-temperature-resistant, modular male header, optimised for SMT processing. You can put together any size by using the 2-pole and 3-pole male header modules.

- Used with Pick & Place machines for faster processing speeds
- Less article numbers
- SL-SMaRT covers both 5.00 and 5.08 mm pitches
- Efficient use of feeder bank: only two reel feeder positions are required on the feeder bank.
- High-pole male headers can also be processed with Pick & Place machines
- No Pick & Place pads required – thus no need for tedious pad removal after soldering
- Packed in tape-on-reel.

Technical data

In compliance with IEC 60664-1 / IEC 61984			
Clamping range, max.	mm ²		
Solid core H05(07) V-U	mm ²		
Stranded H07 V-R			
Flexible H05(07) V-K	mm ²		
Flexible with ferrule	mm ²		
Ferrule with plastic collar	mm ²		
Stripping length	mm		
Screwdriver blade	mm		
According to norm			
Tightening torque range	Nm		
Rated current, max.	A	16.5	14
At ambient temperature		20°C	40°C
For conductor cross-section	mm ²		
Overvoltage category		III	III II
Pollution severity		3	2 2
Rated voltage	V	250	320 400
Rated impulse voltage	kV	4	4 4
UL / CUL (Use Group)		B	C D
Rated voltage	V	300	300
Rated current	A	15	10
AWG conductor	AWG		
CSA (Use Group)		B	C D
Rated voltage	V	300	300
Rated current	A	15	10
AWG conductor	AWG		
General data			
Type of insulation material		LCP GF	
UL 94 flammability rating		V-0	
Contact base material		CuSn	
Material of contact surface		tinned	
Pin dimensions = d	mm	1.2, Octagonal	
Solder eyelet Ø = D	mm	1.4	
Solder eyelet Ø tolerance	mm	+ 0,1	

Product data

IEC: 400 V / 16.5 A
UL: 300 V / 15 A

For additional articles and information, refer to catalog.weidmueller.com

Note:

- Gold-plated contact surfaces on request
- Rated current related to rated cross-section & min. No. of poles.
- P on drawing = pitch
- Rated data refer only to the component itself. Clearance and creepage distances to other components are to be designed in accordance with the relevant application standards.

SL-SMaRT 5.0x/./90 Tape

Tape-on-reel



Dimensioned drawing

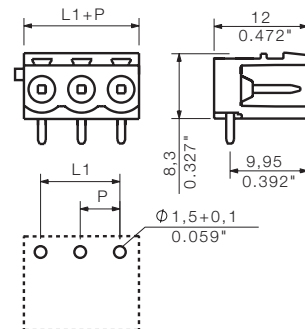

Accessories

Note: Refer to the Accessories chapter for additional accessories.

Coding		Order No.
	BLZ/SL KO OR	1573010000
	BLZ/SL KO SW	1545710000
Partition element		
	SL AT OR	1598300000
	SL AT SW	1770240000
LED light guide		
	SL FLA 1.5/1	1580100000
	SL FLA 1.5/24	1595850000
	SL FLA 2,3/1	1636670000
	SL FLA 2,3/24	1636680000
	SL FLA 3.8/1	1580110000
	SL FLA 3.8/24	1595860000
	SL FLA 9.0/1	1580120000
	SL FLA 9.0/24	1595870000

Ordering data

Solder pin length		1.5 mm		
Colour		Black		
Pitch		5.00 mm		
Pol.	L1	(inch)	Qty.	Order No.
2	5.08	0.200	350	1812430000
3	10.16	0.400	350	1812440000

Tape widths: 32
May be used for 5.00 and 5.08 mm pitches

SL-SMaRT 5.0x../180 Tape

Tape-on-reel



Dimensioned drawing

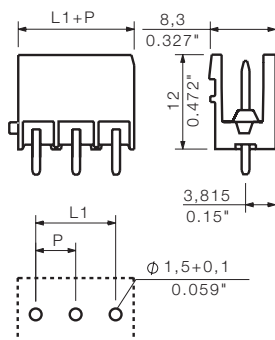

Ordering data

Solder pin length		1.5 mm		
Colour		Black		
Pitch		5.00 mm		
Pol.	L1	(inch)	Qty.	Order No.
2	5.08	0.200	270	1812450000
3	10.16	0.400	270	1812460000

Tape widths: 32
May be used for 5.00 and 5.08 mm pitches

SL-SMaRT

The SL-SMaRT System was developed in order to bring even further improvements to the benefits of conventional SMT/THR components.

The aim was to satisfy the numerous demands of automatic PCB assembly.

The result is a male connector with the following features:

- Minimum weight
- Compact form
- Processing in automatic PCB assembly machines
- Maximum assembly speed
- Standardised automatic packing
- Space-saving feeding in automatic machines (feeder as narrow as possible)
- No pick&place pad required

Automatic PCB assembly machines operate most cost-effectively when they run at maximum speed. This is not possible with heavy components.

The solution is to use 2- and 3-pole male connector modules to interconnect components of any size.

Therefore, by assembling the SL-SMaRT modules in one row, 23 standard male connectors (2- to 24-pole) can already be created.

The optimum tolerance design of the SL-SMaRT modules enables the use at pitches of 5.00 mm (0.197 inch) and 5.08 mm (0.200 inch).

The small pitch deviation is compensated for by the spacing to the next module.

The trick is that by using the appropriate hole layout, the number of standard male connectors replaced increases from 23 to 46 variations.



And the fact that two plug-in directions are available, 90° and 180°, means that the result is increased to 92 variations.

The optimum use of the feeder bank is possible thanks to the need for only four belt conveyor systems with a belt width of 32 mm each.

SLDV-THR 5.08/./180

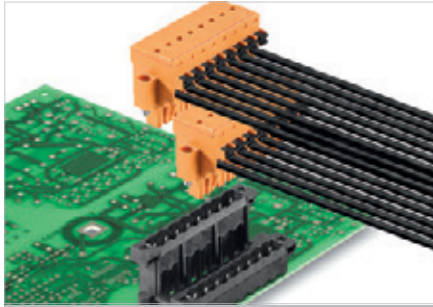

Double-level, high-temperature-resistant male header, optimised for SMT processing. The connection levels are offset and designed for a female plug with screw connection or PUSH IN wire connect. The male headers can be manually coded or ordered as pre-coded headers.

- Available with screw flange (F) or screw & solder flange (FLF).
- The solder flange makes an additional screw-fixation to the PCB unnecessary and protects the solder joints against mechanical stress.
- Available with 1.5 mm or 3.2 mm solder pins.
- The FLF version is featured with a soldering flange and an additional screw-fastening possibility to the PCB.

Technical data

In compliance with IEC 60664-1 / IEC 61984

Clamping range, max.	mm ²		
Solid core H05(07) V-U	mm ²		
Stranded H07 V-R			
Flexible H05(07) V-K	mm ²		
Flexible with ferrule	mm ²		
Ferrule with plastic collar	mm ²		
Stripping length	mm		
Screwdriver blade	mm		
According to norm			
Tightening torque range	Nm		
Rated current, max.	A	15	13
At ambient temperature		20°C	40°C
For conductor cross-section	mm ²		
Overvoltage category		III	III II
Pollution severity		3	2 2
Rated voltage	V	250	320 400
Rated impulse voltage	kV	4	4 4
UL / CUL (Use Group)		B	C D
Rated voltage	V	300	300
Rated current	A	10	10
AWG conductor	AWG		
CSA (Use Group)		B	C D
Rated voltage	V	300	300
Rated current	A	10	10
AWG conductor	AWG		
General data			
Type of insulation material		LCP GF	
UL 94 flammability rating		V-0	
Contact base material		CuSn	
Material of contact surface		tinned	
Pin dimensions = d	mm	1.2, Octagonal	
Solder eyelet Ø = D	mm	1.5	
Solder eyelet Ø tolerance	mm	+ 0,1	

Product data

IEC: 400 V / 15 A
UL: 300 V / 10 A

For additional articles and information, refer to catalog.weidmueller.com

Note:

- Rated current related to rated cross-section & min. No. of poles.
- Spacing between rows: see hole layout
- P on drawing = pitch
- Rated data refer only to the component itself. Clearance and creepage distances to other components are to be designed in accordance with the relevant application standards.

SLDV-THR 5.08/./180F

Packaged in box



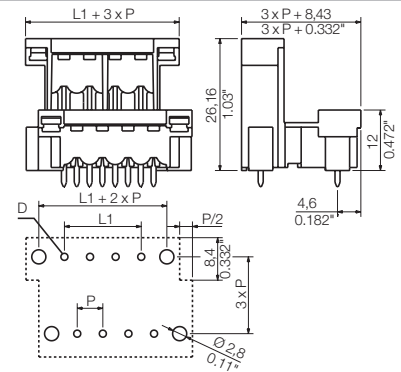

Dimensioned drawing



Accessories

Note: Refer to the Accessories chapter for additional accessories.

Coding		Order No.
	BLZ/SL KO OR	1573010000
	BLZ/SL KO SW	1545710000
Partition element		
	SL AT OR	1598300000
	SL AT SW	1770240000

Ordering data

Solder pin length		1.5 mm	3.2 mm
Colour		Black	Black
Pitch 5.08 mm			
Pol.	L1 (inch)	Qty.	Order No.
4	5.08	0.200	50 1828890000 1828770000
6	10.16	0.400	50 1828900000 1828780000
8	15.24	0.600	50 1828910000 1828790000
10	20.32	0.800	50 1828920000 1828800000
12	25.40	1.000	50 1828930000 1828810000
14	30.48	1.200	20 1828940000 1828820000
16	35.56	1.400	20 1828950000 1828830000
18	40.64	1.600	20 1828960000 1828840000
20	45.72	1.800	20 1828970000 1828850000
22	50.80	2.000	10 1828980000 1828860000
24	55.88	2.200	10 1828990000 1828870000
26	60.96	2.400	10 1829000000 1828880000
28	66.04	2.600	10 1881310000 1889340000
30	71.12	2.800	10 1881320000 1889350000
32	76.20	3.000	10 1881330000 1866330000
34	81.28	3.200	10 1881350000 1889360000
36	86.36	3.400	10 1881360000 1889370000
38	91.44	3.600	10 1881380000 1889380000
40	96.52	3.800	10 1881410000 1889390000
42	101.60	4.000	10 1881430000 1889400000
44	106.68	4.200	10 1881440000 1889410000
46	111.76	4.400	10 1881450000 1889420000
48	116.84	4.600	10 1881460000 1889430000

SLDV-THR 5.08../180FLF

Packaged in box; with solder flange



Dimensioned drawing

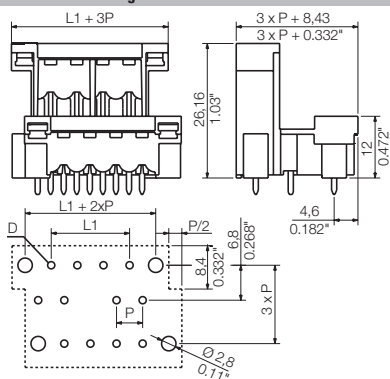

Ordering data

Solder pin length		1.5 mm	3.2 mm		
Colour		Black	Black		
Pitch		5.08 mm			
Pol.	L1 (inch)	Qty.	Order No.	Order No.	
4	5.08	0.200	50	1829130000	1829010000
6	10.16	0.400	50	1829140000	1829020000
8	15.24	0.600	50	1829150000	1829030000
10	20.32	0.800	50	1829160000	1829040000
12	25.40	1.000	50	1829170000	1829050000
14	30.48	1.200	20	1829180000	1829060000
16	35.56	1.400	20	1829190000	1829070000
18	40.64	1.600	20	1829200000	1829080000
20	45.72	1.800	20	1829210000	1829090000
22	50.80	2.000	10	1829220000	1829100000
24	55.88	2.200	10	1829230000	1829110000
26	60.96	2.400	10	1829240000	1829120000
28	66.04	2.600	10	1881480000	1889200000
30	71.12	2.800	10	1881500000	1889210000
32	76.20	3.000	10	1881510000	1886320000
34	81.28	3.200	10	1881520000	1889220000
36	86.36	3.400	10	1881530000	1889270000
38	91.44	3.600	10	1881540000	1889280000
40	96.52	3.800	10	1881550000	1889290000
42	101.60	4.000	10	1881560000	1889300000
44	106.68	4.200	10	1881570000	1889310000
46	111.76	4.400	10	1881580000	1889320000
48	116.84	4.600	10	1881590000	1889330000

SLH-THR 5.08/./180

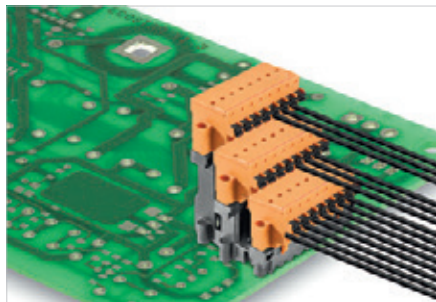

High temperature-resistant male header, optimised for SMT processing. Makes a compact 3-row male header when used together with the SLDV-THR. The connection levels are offset and designed for a female plug with screw connection or PUSH IN wire connect. The male headers can be manually coded or ordered as pre-coded headers.

Technical data

In compliance with IEC 60664-1 / IEC 61984			
Clamping range, max.	mm ²		
Solid core H05(07) V-U	mm²		
Stranded H07 V-R			
Flexible H05(07) V-K	mm ²		
Flexible with ferrule	mm ²		
Ferrule with plastic collar	mm ²		
Stripping length	mm		
Screwdriver blade	mm		
According to norm			
Tightening torque range	Nm		
Rated current, max.	A	18	13
At ambient temperature		20°C	40°C
For conductor cross-section	mm ²		
Overvoltage category		III	III II
Pollution severity		3	2 2
Rated voltage	V	200	320 320
Rated impulse voltage	kV	4	4 4
UL / CUL (Use Group)		B	C D
Rated voltage	V	300	300
Rated current	A	10	10
AWG conductor	AWG		-
CSA (Use Group)		B	C D
Rated voltage	V	300	300
Rated current	A	13	10
AWG conductor	AWG		-
General data			
Type of insulation material		LCP GF	
UL 94 flammability rating		V-0	
Contact base material		CuSn	
Material of contact surface		tinned	
Pin dimensions = d	mm	1.2, Octagonal	
Solder eyelet Ø = D	mm	1.5	
Solder eyelet Ø tolerance	mm	+ 0,1	

Product data

IEC: 320 V / 18 A
UL: 300 V / 10 A

For additional articles and information, refer to catalog.weidmueller.com

Note:

- Rated current related to rated cross-section & min. No. of poles.
- Rated data refer only to the component itself. Clearance and creepage distances to other components are to be designed in accordance with the relevant application standards.

SLH-THR 5.08/./180F



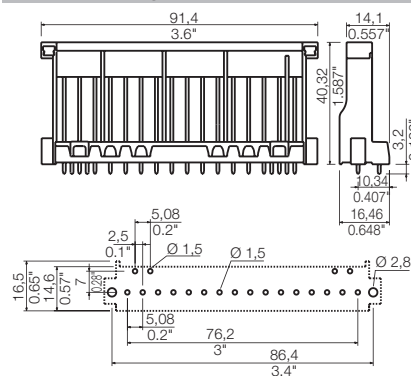

Dimensioned drawing



Accessories

Note: Refer to the Accessories chapter for additional accessories.

Coding		Order No.
	BLZ/SL KO OR	1573010000
	BLZ/SL KO SW	1545710000
Partition element		
	SL AT OR	1598300000
	SL AT SW	1770240000

Ordering data

Solder pin length	3.2 mm			
Colour	Black			
Pitch	5.08 mm			
Pol.	L1	(inch)	Qty.	Order No.
16	91.40	3.600	10	1190600000

SL 5.08HC/./90

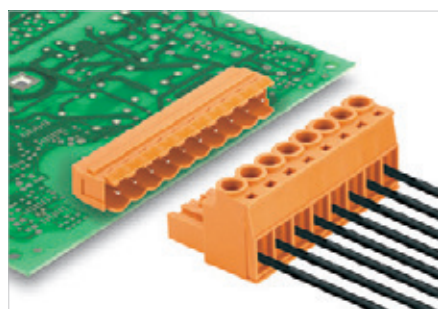

Male headers made from glass-fibre-reinforced plastic with 90° wire outlet; optimised for wave soldering, absolute dimension stable. The male headers can be manually coded or ordered as pre-coded headers.

- Available in open, closed (G), with screw flange (F) or with solder flange (LF).
- The solder flange makes an additional screw-fixation to the PCB unnecessary and protects the solder joints against mechanical stress.

Product data

IEC: 400 V / 24 A
UL: 300 V / 15 A

For additional articles and information, refer to catalog.weidmuller.com

Note:

- Additional colours on request
- Gold-plated contact surfaces on request
- Rated current related to rated cross-section & min. No. of poles.
- P on drawing = pitch
- Rated data refer only to the component itself. Clearance and creepage distances to other components are to be designed in accordance with the relevant application standards.

SL 5.08HC/./90

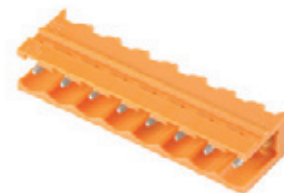

Dimensioned drawing

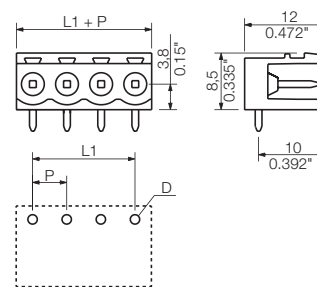

Technical data

In compliance with IEC 60664-1 / IEC 61984			
Clamping range, max.	mm ²		
Solid core H05(07) V-U	mm²		
Stranded H07 V-R			
Flexible H05(07) V-K	mm ²		
Flexible with ferrule	mm ²		
Ferrule with plastic collar	mm ²		
Stripping length	mm		
Screwdriver blade	mm		
According to norm			
Tightening torque range	Nm		
Rated current, max.	A	24	21
At ambient temperature		20°C	40°C
For conductor cross-section	mm ²		
Overvoltage category		III	III II
Pollution severity		3	2 2
Rated voltage	V	250	320 400
Rated impulse voltage	kV	4	4 4
UL / CUL (Use Group)		B	C D
Rated voltage	V	300	300
Rated current	A	15	10
AWG conductor	AWG		
CSA (Use Group)		B	C D
Rated voltage	V	300	300
Rated current	A	15	10
AWG conductor	AWG		
General data			
Type of insulation material		PA GF	
UL 94 flammability rating		V-0	
Contact base material		Copper alloy	
Material of contact surface		tinned	
Pin dimensions = d	mm	1.2, Octagonal	
Solder eyelet Ø = D	mm	1.3	
Solder eyelet Ø tolerance	mm	+ 0,1	

Accessories

Note: Refer to the Accessories chapter for additional accessories.		
Coding		Order No.
	BLZ/SL KO OR	1573010000
	BLZ/SL KO SW	1545710000
Partition element		
	SL AT OR	1598300000
	SL AT SW	1770240000
LED light guide		
	SL FLA 1.5/1	1580100000
	SL FLA 1.5/24	1595850000
	SL FLA 2,3/1	1636670000
	SL FLA 2,3/24	1636680000
	SL FLA 3.8/1	1580110000
	SL FLA 3.8/24	1595860000
Mounting block	SL FLA 9.0/1	1580120000
	SL FLA 9.0/24	1595870000
	SLA BB11R OR	1604120000
	SLA BB11R SW	1692340000

Ordering data

Solder pin length		3.2 mm	3.2 mm		
Colour		Orange	Black		
Pitch 5.08 mm					
Pol.	L1 (inch)	Qty.	Order No.		
2	5.08	0.200	100	1146720000	1155030000
3	10.16	0.400	100	1146740000	1155040000
4	15.24	0.600	100	1146770000	1155050000
5	20.32	0.800	50	1146790000	1155060000
6	25.40	1.000	50	1146810000	1155070000
7	30.48	1.200	50	1146830000	1155080000
8	35.56	1.400	50	1146850000	1155090000
9	40.64	1.600	50	1146880000	1155100000
10	45.72	1.800	50	1146900000	1155130000
11	50.80	2.000	50	1146920000	1155140000
12	55.88	2.200	50	1146940000	1155150000
13	60.96	2.400	50	1146970000	1155170000
14	66.04	2.600	50	1146990000	1155180000
15	71.12	2.800	50	1147010000	1155190000
16	76.20	3.000	50	1147030000	1155200000
17	81.28	3.200	20	1147050000	1155230000
18	86.36	3.400	20	1147080000	1155240000
19	91.44	3.600	20	1147100000	1155250000
20	96.52	3.800	20	1147120000	1155270000
21	101.60	4.000	20	1147150000	1155280000
22	106.68	4.200	20	1147190000	1155290000
23	111.76	4.400	20	1147220000	1155300000
24	116.84	4.600	20	1147250000	1155310000

SL 5.08HC/./90G



SL 5.08HC/./90B



Dimensioned drawing

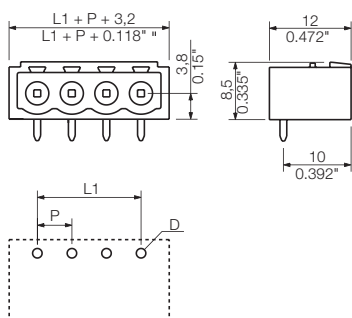

Dimensioned drawing

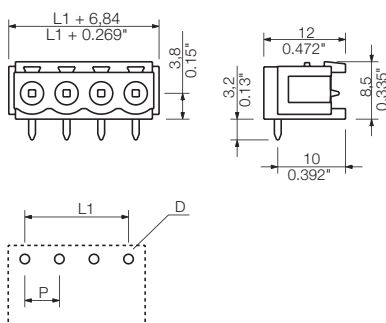

Ordering data

Solder pin length		3.2 mm	3.2 mm		
Colour		Orange	Black		
Pitch		5.08 mm			
Pol.	L1 (inch)	Qty.	Order No.	Order No.	
2	5.08	0.200	100	1147280000	1155320000
3	10.16	0.400	100	1147310000	1155330000
4	15.24	0.600	100	1147340000	1155340000
5	20.32	0.800	50	1147370000	1155350000
6	25.40	1.000	50	1147400000	1155370000
7	30.48	1.200	50	1147420000	1155380000
8	35.56	1.400	50	1147450000	1155390000
9	40.64	1.600	50	1147490000	1155400000
10	45.72	1.800	50	1147530000	1155410000
11	50.80	2.000	50	1147570000	1155420000
12	55.88	2.200	50	1147600000	1155430000
13	60.96	2.400	50	1147630000	1155440000
14	66.04	2.600	50	1147680000	1155450000
15	71.12	2.800	50	1147700000	1155470000
16	76.20	3.000	50	1147740000	1155480000
17	81.28	3.200	20	1147780000	1155490000
18	86.36	3.400	20	1147810000	1155500000
19	91.44	3.600	20	1147840000	1155510000
20	96.52	3.800	20	1147880000	1155520000
21	101.60	4.000	20	1147910000	1155530000
22	106.68	4.200	20	1147940000	1155540000
23	111.76	4.400	20	1147980000	1155550000
24	116.84	4.600	20	1148000000	1155570000

Ordering data

Solder pin length		3.2 mm	3.2 mm		
Colour		Orange	Black		
Pitch		5.08 mm			
Pol.	L1 (inch)	Qty.	Order No.	Order No.	
2	5.08	0.200	100	1148030000	1155580000
3	10.16	0.400	100	1148070000	1155590000
4	15.24	0.600	100	1148100000	1155600000
5	20.32	0.800	50	1148130000	1155610000
6	25.40	1.000	50	1148170000	1155620000
7	30.48	1.200	50	1148200000	1155630000
8	35.56	1.400	50	1154830000	1155640000
9	40.64	1.600	50	1154840000	1155650000
10	45.72	1.800	50	1154850000	1155670000
11	50.80	2.000	50	1154870000	1155680000
12	55.88	2.200	50	1154880000	1155690000
13	60.96	2.400	50	1154890000	1155700000
14	66.04	2.600	50	1154900000	1155710000
15	71.12	2.800	50	1154910000	1155720000
16	76.20	3.000	50	1154920000	1155730000
17	81.28	3.200	20	1154930000	1155740000
18	86.36	3.400	20	1154940000	1155750000
19	91.44	3.600	20	1154950000	1155770000
20	96.52	3.800	20	1154970000	1155780000
21	101.60	4.000	20	1154980000	1155790000
22	106.68	4.200	20	1154990000	1155800000
23	111.76	4.400	20	1155010000	1155810000
24	116.84	4.600	20	1155020000	1155820000

SL 5.08HC/./90

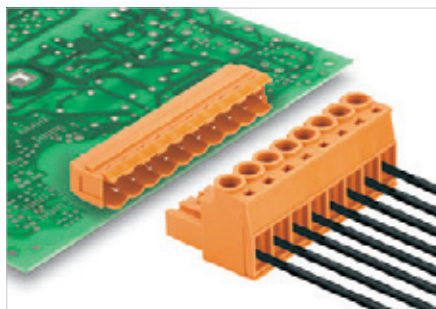

Male headers made from glass-fibre-reinforced plastic with 90° wire outlet; optimised for wave soldering, absolute dimension stable. The male headers can be manually coded or ordered as pre-coded headers.

- Available in open, closed (G), with screw flange (F) or with solder flange (LF).
- The solder flange makes an additional screw-fixation to the PCB unnecessary and protects the solder joints against mechanical stress.

Product data

IEC: 400 V / 24 A
UL: 300 V / 15 A

For additional articles and information, refer to catalog.weidmueller.com

Note:

- Additional colours on request
- Gold-plated contact surfaces on request
- Rated current related to rated cross-section & min. No. of poles.
- P on drawing = pitch
- Rated data refer only to the component itself. Clearance and creepage distances to other components are to be designed in accordance with the relevant application standards.

SL 5.08HC/./90F



Dimensioned drawing

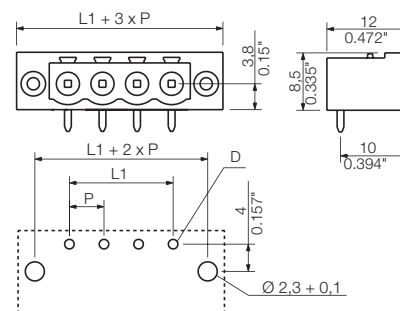

Technical data

In compliance with IEC 60664-1 / IEC 61984			
Clamping range, max.	mm ²		
Solid core H05(07) V-U	mm ²		
Stranded H07 V-R			
Flexible H05(07) V-K	mm ²		
Flexible with ferrule	mm ²		
Ferrule with plastic collar	mm ²		
Stripping length	mm		
Screwdriver blade	mm		
According to norm			
Tightening torque range	Nm		
Rated current, max.	A	24	21
At ambient temperature		20°C	40°C
For conductor cross-section	mm ²		
Overvoltage category		III	III II
Pollution severity		3	2 2
Rated voltage	V	250	320 400
Rated impulse voltage	kV	4	4 4
UL / CUL (Use Group)		B	C D
Rated voltage	V	300	300
Rated current	A	15	10
AWG conductor	AWG		
CSA (Use Group)		B	C D
Rated voltage	V	300	300
Rated current	A	15	10
AWG conductor	AWG		
General data			
Type of insulation material		PA GF	
UL 94 flammability rating		V-0	
Contact base material		Copper alloy	
Material of contact surface		tinned	
Pin dimensions = d	mm	1.2, Octagonal	
Solder eyelet Ø = D	mm	1.3	
Solder eyelet Ø tolerance	mm	+ 0,1	

Accessories

Note: Refer to the Accessories chapter for additional accessories.

Coding		Order No.
	BLZ/SL KO OR	1573010000
	BLZ/SL KO SW	1545710000
Partition element		
	SL AT OR	1598300000
	SL AT SW	1770240000
LED light guide		
	SL FLA 1.5/1	1580100000
	SL FLA 1.5/24	1595850000
	SL FLA 2,3/1	1636670000
	SL FLA 2,3/24	1636680000
	SL FLA 3.8/1	1580110000
	SL FLA 3.8/24	1595860000
	SL FLA 9.0/1	1580120000
	SL FLA 9.0/24	1595870000

Ordering data

Solder pin length		3.2 mm	3.2 mm		
Colour		Orange	Black		
Pitch 5.08 mm					
Pol.	L1 (inch)	Qty.	Order No.	Order No.	
2	5.08	0.200	100	1148610000	1150090000
3	10.16	0.400	100	1148640000	1150100000
4	15.24	0.600	100	1148680000	1150110000
5	20.32	0.800	50	1148710000	1150120000
6	25.40	1.000	50	1148740000	1150130000
7	30.48	1.200	50	1148780000	1150140000
8	35.56	1.400	50	1148810000	1150150000
9	40.64	1.600	50	1148840000	1150170000
10	45.72	1.800	50	1148880000	1150180000
11	50.80	2.000	50	1148910000	1150190000
12	55.88	2.200	50	1148940000	1150200000
13	60.96	2.400	50	1148980000	1150210000
14	66.04	2.600	50	1149010000	1150220000
15	71.12	2.800	50	1149040000	1150230000
16	76.20	3.000	50	1149080000	1150240000
17	81.28	3.200	20	1149110000	1150250000
18	86.36	3.400	20	1149140000	1150270000
19	91.44	3.600	20	1149180000	1150280000
20	96.52	3.800	20	1149210000	1150290000
21	101.60	4.000	20	1149240000	1150300000
22	106.68	4.200	20	1149280000	1150310000
23	111.76	4.400	20	1149310000	1150320000
24	116.84	4.600	20	1149340000	1150330000

SL 5.08HC/./90LF

with solder flange



Dimensioned drawing

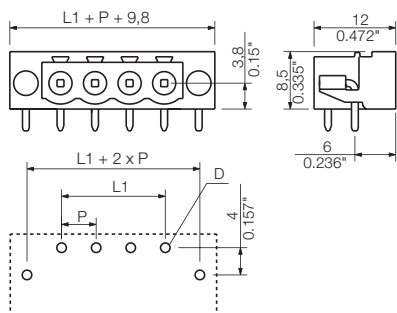

Solder flange (LF)

Normally you use a pin header with fastening flanges (F) in combination with a screw from the rear side of the PCB to increase the fixation forces of the pin headers. The disadvantages are additional process steps that make the PCB mounting complex and cost intensive. The patented solder flange was designed to solve exactly this problem and find a simple and cheap solution. The additional solder pins substitute the present screw flanges and they get soldered together with the pin header. This terminates additional process steps and thus reduces production costs. The additional fixation protects the soldered connections from tensile strain and avoids permanent mechanical stress such as caused by the post-fastened screw forces.

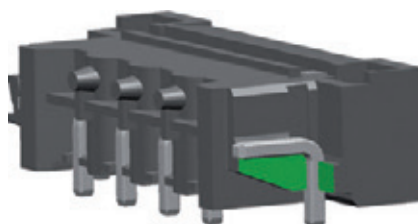

Ordering data

Solder pin length		3.2 mm	3.2 mm		
Colour		Orange	Black		
Pitch		5.08 mm			
Pol.	L1 (inch)	Qty.	Order No.		
2	5.08	0.200	100	1149380000	1150340000
3	10.16	0.400	100	1149410000	1150350000
4	15.24	0.600	100	1149440000	1150370000
5	20.32	0.800	50	1149480000	1150380000
6	25.40	1.000	50	1149510000	1150390000
7	30.48	1.200	50	1149540000	1150400000
8	35.56	1.400	50	1149580000	1150410000
9	40.64	1.600	50	1149610000	1150420000
10	45.72	1.800	50	1149640000	1150430000
11	50.80	2.000	50	1149680000	1150440000
12	55.88	2.200	50	1149710000	1150450000
13	60.96	2.400	50	1149740000	1150470000
14	66.04	2.600	50	1149780000	1150480000
15	71.12	2.800	50	1149810000	1150490000
16	76.20	3.000	50	1149840000	1150500000
17	81.28	3.200	20	1149880000	1150510000
18	86.36	3.400	20	1149910000	1150520000
19	91.44	3.600	20	1149940000	1150530000
20	96.52	3.800	20	1149980000	1150540000
21	101.60	4.000	20	1150000000	1150550000
22	106.68	4.200	20	1150020000	1150570000
23	111.76	4.400	20	1150040000	1150580000
24	116.84	4.600	20	1150070000	1150590000

SL 5.08HC/./180

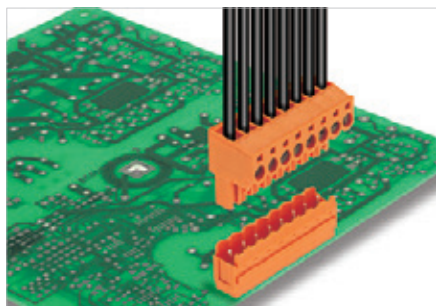

Male headers made from glass-fibre-reinforced plastic with 180° wire outlet; optimised for wave soldering, absolut dimension stable. The male headers can be manually coded or ordered as pre-coded headers.

- Available in open, closed (G), with screw flange (F) or with solder flange (LF).
- The solder flange makes an additional screw-fixation to the PCB unnecessary and protects the solder joints against mechanical stress.

Product data

IEC: 400 V / 24 A
UL: 300 V / 16 A

For additional articles and information, refer to catalog.weidmueller.com

- Note:**
- Additional colours on request
 - Gold-plated contact surfaces on request
 - Rated current related to rated cross-section & min. No. of poles.
 - P on drawing = pitch
 - Rated data refer only to the component itself. Clearance and creepage distances to other components are to be designed in accordance with the relevant application standards.

SL 5.08HC/./180



Dimensioned drawing

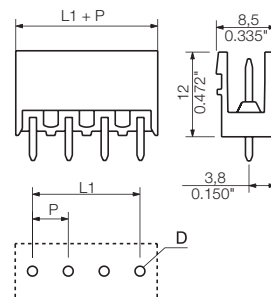

Technical data

In compliance with IEC 60664-1 / IEC 61984			
Clamping range, max.	mm ²		
Solid core H05(07) V-U	mm ²		
Stranded H07 V-R			
Flexible H05(07) V-K	mm ²		
Flexible with ferrule	mm ²		
Ferrule with plastic collar	mm ²		
Stripping length	mm		
Screwdriver blade	mm		
According to norm			
Tightening torque range	Nm		
Rated current, max.	A	24	21
At ambient temperature		20°C	40°C
For conductor cross-section	mm ²		
Overvoltage category		III	III II
Pollution severity		3	2 2
Rated voltage	V	250	320 400
Rated impulse voltage	kV	4	4 4
UL / CUL (Use Group)	B C D		
Rated voltage	V	300	300
Rated current	A	16	10
AWG conductor	AWG		
CSA (Use Group)	B C D		
Rated voltage	V	300	300
Rated current	A	15	10
AWG conductor	AWG		
General data			
Type of insulation material		PA GF	
UL 94 flammability rating		V-0	
Contact base material		Copper alloy	
Material of contact surface		tinned	
Pin dimensions = d	mm	1.2, Octagonal	
Solder eyelet Ø = D	mm	1.3	
Solder eyelet Ø tolerance	mm	+ 0,1	

Accessories

Note: Refer to the Accessories chapter for additional accessories.

Coding		Order No.
	BLZ/SL KO OR	1573010000
	BLZ/SL KO SW	1545710000
Partition element		
	SL AT OR	1598300000
	SL AT SW	1770240000
Mounting block		
	SLA BB11R OR	1604120000
	SLA BB11R SW	1692340000

Ordering data

Solder pin length		3.2 mm	3.2 mm	
Colour		Orange	Black	
Pitch 5.08 mm				
Pol.	L1 (inch)	Qty.	Order No.	Order No.
2	5.08	0.200	100	1146320000 1148080000
3	10.16	0.400	100	1146340000 1148110000
4	15.24	0.600	100	1146380000 1148140000
5	20.32	0.800	50	1146410000 1148180000
6	25.40	1.000	50	1146450000 1148210000
7	30.48	1.200	50	1146470000 1148230000
8	35.56	1.400	50	1146490000 1148250000
9	40.64	1.600	50	1146510000 1148270000
10	45.72	1.800	50	1146530000 1148290000
11	50.80	2.000	50	1146550000 1148310000
12	55.88	2.200	50	1146570000 1148330000
13	60.96	2.400	50	1146580000 1148350000
14	66.04	2.600	50	1146590000 1148370000
15	71.12	2.800	50	1146600000 1148390000
16	76.20	3.000	50	1146610000 1148410000
17	81.28	3.200	20	1146620000 1148430000
18	86.36	3.400	20	1146630000 1148450000
19	91.44	3.600	20	1146640000 1148480000
20	96.52	3.800	20	1146650000 1148510000
21	101.60	4.000	20	1146680000 1148530000
22	106.68	4.200	20	1146690000 1148550000
23	111.76	4.400	20	1146700000 1148580000
24	116.84	4.600	20	1146710000 1148600000

SL 5.08HC/./180G

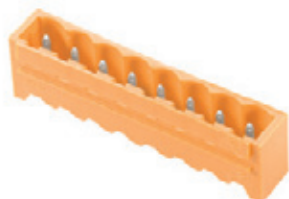

SL 5.08HC/./180B

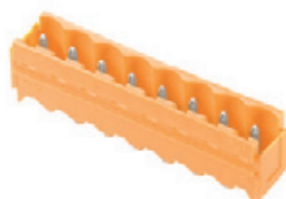

Dimensioned drawing

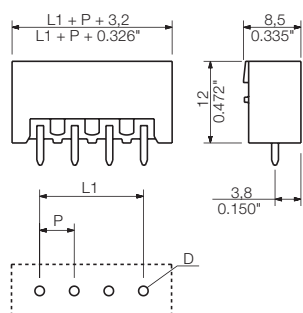

Dimensioned drawing

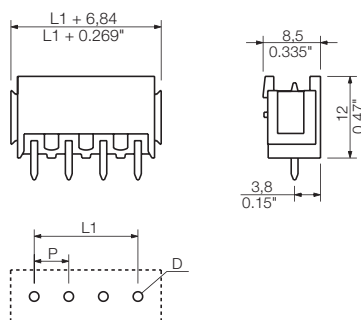

Ordering data

Solder pin length		3.2 mm	3.2 mm		
Colour		Orange	Black		
Pitch		5.08 mm			
Pol.	L1 (inch)	Qty.	Order No.	Order No.	
2	5.08	0.200	100	1146730000	1148630000
3	10.16	0.400	100	1146750000	1148670000
4	15.24	0.600	100	1146780000	1148700000
5	20.32	0.800	50	1146800000	1148730000
6	25.40	1.000	50	1146820000	1148770000
7	30.48	1.200	50	1146840000	1148800000
8	35.56	1.400	50	1146870000	1148830000
9	40.64	1.600	50	1146890000	1148870000
10	45.72	1.800	50	1146910000	1148900000
11	50.80	2.000	50	1146930000	1148930000
12	55.88	2.200	50	1146950000	1148970000
13	60.96	2.400	50	1146980000	1149000000
14	66.04	2.600	50	1147000000	1149030000
15	71.12	2.800	50	1147020000	1149070000
16	76.20	3.000	50	1147040000	1149100000
17	81.28	3.200	20	1147070000	1149130000
18	86.36	3.400	20	1147090000	1149170000
19	91.44	3.600	20	1147110000	1149200000
20	96.52	3.800	20	1147140000	1149230000
21	101.60	4.000	20	1147180000	1149270000
22	106.68	4.200	20	1147210000	1149300000
23	111.76	4.400	20	1147240000	1149330000
24	116.84	4.600	20	1147270000	1149370000

Ordering data

Solder pin length		3.2 mm	3.2 mm		
Colour		Orange	Black		
Pitch		5.08 mm			
Pol.	L1 (inch)	Qty.	Order No.	Order No.	
2	5.08	0.200	100	1147300000	1149400000
3	10.16	0.400	100	1147330000	1149430000
4	15.24	0.600	100	1147360000	1149470000
5	20.32	0.800	50	1147390000	1149500000
6	25.40	1.000	50	1147430000	1149530000
7	30.48	1.200	50	1147470000	1149570000
8	35.56	1.400	50	1147510000	1149600000
9	40.64	1.600	50	1147540000	1149630000
10	45.72	1.800	50	1147580000	1149670000
11	50.80	2.000	50	1147610000	1149700000
12	55.88	2.200	50	1147640000	1149730000
13	60.96	2.400	50	1147670000	1149770000
14	66.04	2.600	50	1147710000	1149800000
15	71.12	2.800	50	1147730000	1149830000
16	76.20	3.000	50	1147770000	1149870000
17	81.28	3.200	20	1147800000	1149900000
18	86.36	3.400	20	1147830000	1149930000
19	91.44	3.600	20	1147870000	1149970000
20	96.52	3.800	20	1147900000	1149990000
21	101.60	4.000	20	1147930000	1150010000
22	106.68	4.200	20	1147970000	1150030000
23	111.76	4.400	20	1148010000	1150050000
24	116.84	4.600	20	1148040000	1150080000

SL 5.08HC/./180

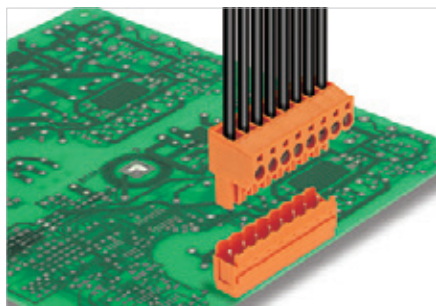

Male headers made from glass-fibre-reinforced plastic with 180° wire outlet; optimised for wave soldering, absolut dimension stable. The male headers can be manually coded or ordered as pre-coded headers.

- Available in open, closed (G), with screw flange (F) or with solder flange (LF).
- The solder flange makes an additional screw-fixation to the PCB unnecessary and protects the solder joints against mechanical stress.

Product data

IEC: 400 V / 24 A
UL: 300 V / 16 A

For additional articles and information, refer to catalog.weidmueller.com

- Note:**
- Additional colours on request
 - Gold-plated contact surfaces on request
 - Rated current related to rated cross-section & min. No. of poles.
 - P on drawing = pitch
 - Rated data refer only to the component itself. Clearance and creepage distances to other components are to be designed in accordance with the relevant application standards.

SL 5.08HC/./180F



Dimensioned drawing

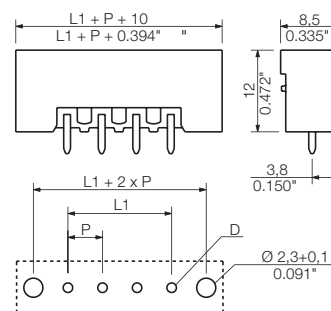

Technical data

In compliance with IEC 60664-1 / IEC 61984			
Clamping range, max.	mm ²		
Solid core H05(07) V-U	mm ²		
Stranded H07 V-R			
Flexible H05(07) V-K	mm ²		
Flexible with ferrule	mm ²		
Ferrule with plastic collar	mm ²		
Stripping length	mm		
Screwdriver blade	mm		
According to norm			
Tightening torque range	Nm		
Rated current, max.	A	24	21
At ambient temperature		20°C	40°C
For conductor cross-section	mm ²		
Overvoltage category		III	III II
Pollution severity		3	2 2
Rated voltage	V	250	320 400
Rated impulse voltage	kV	4	4 4
UL / CUL (Use Group)	B C D		
Rated voltage	V	300	300
Rated current	A	16	10
AWG conductor	AWG		
CSA (Use Group)	B C D		
Rated voltage	V	300	300
Rated current	A	15	10
AWG conductor	AWG		
General data			
Type of insulation material		PA GF	
UL 94 flammability rating		V-0	
Contact base material		Copper alloy	
Material of contact surface		tinned	
Pin dimensions = d	mm	1.2, Octagonal	
Solder eyelet Ø = D	mm	1.3	
Solder eyelet Ø tolerance	mm	+ 0,1	

Accessories

Note: Refer to the Accessories chapter for additional accessories.

Coding		Order No.
	BLZ/SL KO OR	1573010000
	BLZ/SL KO SW	1545710000
Partition element		
	SL AT OR	1598300000
	SL AT SW	1770240000

Ordering data

Solder pin length		3.2 mm	3.2 mm		
Colour		Orange	Black		
Pitch 5.08 mm					
Pol.	L1	(inch)	Qty.	Order No.	Order No.
2	5.08	0.200	100	1147130000	1148490000
3	10.16	0.400	100	1147170000	1148520000
4	15.24	0.600	100	1147200000	1148540000
5	20.32	0.800	50	1147230000	1148570000
6	25.40	1.000	50	1147260000	1148590000
7	30.48	1.200	50	1147290000	1148620000
8	35.56	1.400	50	1147320000	1148650000
9	40.64	1.600	50	1147350000	1148690000
10	45.72	1.800	50	1147380000	1148720000
11	50.80	2.000	50	1147410000	1148750000
12	55.88	2.200	50	1147440000	1148790000
13	60.96	2.400	50	1147480000	1148820000
14	66.04	2.600	50	1147520000	1148850000
15	71.12	2.800	50	1147550000	1148890000
16	76.20	3.000	50	1147590000	1148920000
17	81.28	3.200	20	1147620000	1148950000
18	86.36	3.400	20	1147650000	1148990000
19	91.44	3.600	20	1147690000	1149020000
20	96.52	3.800	20	1147720000	1149050000
21	101.60	4.000	20	1147750000	1149090000
22	106.68	4.200	20	1147790000	1149120000
23	111.76	4.400	20	1147820000	1149150000
24	116.84	4.600	20	1147850000	1149190000

SL 5.08HC../180LF

with solder flange

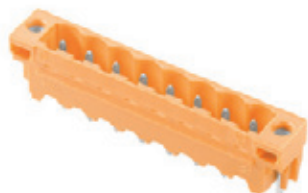

Dimensioned drawing

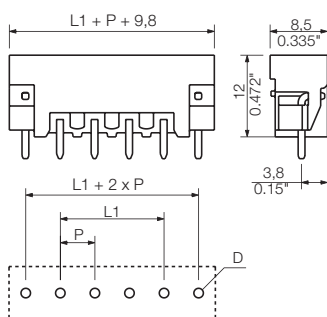

Ordering data

Solder pin length		3.2 mm	3.2 mm		
Colour		Orange	Black		
Pitch		5.08 mm			
Pol.	L1	(inch)	Qty.	Order No.	Order No.
2	5.08	0.200	100	1147890000	1149220000
3	10.16	0.400	100	1147920000	1149250000
4	15.24	0.600	100	1147950000	1149290000
5	20.32	0.800	50	1147990000	1149320000
6	25.40	1.000	50	1148020000	1149350000
7	30.48	1.200	50	1148050000	1149390000
8	35.56	1.400	50	1148090000	1149420000
9	40.64	1.600	50	1148120000	1149450000
10	45.72	1.800	50	1148150000	1149490000
11	50.80	2.000	50	1148190000	1149520000
12	55.88	2.200	50	1148220000	1149550000
13	60.96	2.400	50	1148240000	1149590000
14	66.04	2.600	50	1148260000	1149620000
15	71.12	2.800	50	1148280000	1149650000
16	76.20	3.000	50	1148300000	1149690000
17	81.28	3.200	20	1148320000	1149720000
18	86.36	3.400	20	1148340000	1149750000
19	91.44	3.600	20	1148360000	1149790000
20	96.52	3.800	20	1148380000	1149820000
21	101.60	4.000	20	1148400000	1149850000
22	106.68	4.200	20	1148420000	1149890000
23	111.76	4.400	20	1148440000	1149920000
24	116.84	4.600	20	1148470000	1149950000

SLD 5.08V/./90 & 180

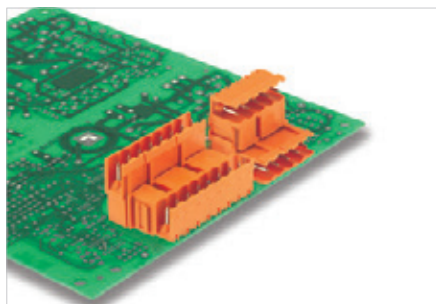

Double-level male header optimised for wave soldering. The connection levels are offset and designed for a female plug with screw- or PUSH IN wire connect. All male headers can be manually coded or ordered as pre-coded headers.

Technical data

In compliance with IEC 60664-1 / IEC 61984			
Clamping range, max.	mm ²		
Solid core H05(07) V-U	mm²		
Stranded H07 V-R			
Flexible H05(07) V-K	mm ²		
Flexible with ferrule	mm ²		
Ferrule with plastic collar	mm ²		
Stripping length	mm		
Screwdriver blade	mm		
According to norm			
Tightening torque range	Nm		
Rated current, max.	A	17	15
At ambient temperature		20°C	40°C
For conductor cross-section	mm ²		
Overvoltage category		III	III II
Pollution severity		3	2 2
Rated voltage	V	250	320 400
Rated impulse voltage	kV	4	4 4
UL / CUL (Use Group)		B	C D
Rated voltage	V	300	300
Rated current	A	10	10
AWG conductor	AWG		
CSA (Use Group)		B	C D
Rated voltage	V	300	300
Rated current	A	10	10
AWG conductor	AWG		
General data			
Type of insulation material		PBT	
UL 94 flammability rating		V-0	
Contact base material		CuSn	
Material of contact surface		tinned	
Pin dimensions = d	mm	1.2, Octagonal	
Solder eyelet Ø = D	mm	1.3	
Solder eyelet Ø tolerance	mm	+ 0,1	

Product data

IEC: 400 V / 17 A
UL: 300 V / 10 A

For additional articles and information, refer to catalog.weidmueller.com

Note:

- Additional colours on request
- Rated current related to rated cross-section & min. No. of poles.
- Spacing between rows: see hole layout
- P on drawing = pitch
- Rated data refer only to the component itself. Clearance and creepage distances to other components are to be designed in accordance with the relevant application standards.

SLD 5.08V/90



Dimensioned drawing

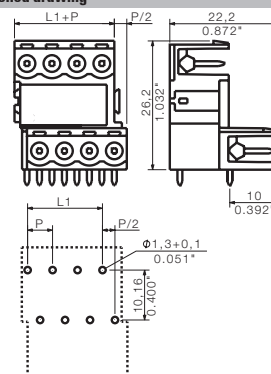

Accessories

Note: Refer to the Accessories chapter for additional accessories.

Mounting block		Order No.
	SLA BB14 OR	1594200000
	SLA BB14 SW	1774460000
Coding		
	BLZ/SL KO OR	1573010000
	BLZ/SL KO SW	1545710000
Partition element		
	SL AT OR	1598300000
	SL AT SW	1770240000

Ordering data

Solder pin length		3.2 mm		
Colour		Orange		
Pitch	5.08 mm			
Pol.	L1	(inch)	Qty.	Order No.
4	5.08	0.200	50	1725170000
6	25.40	1.000	50	1725180000
8	35.56	1.400	50	1725190000
10	45.72	1.800	50	1725200000
12	55.88	2.200	50	1725210000
14	66.04	2.600	20	1725220000
16	76.20	3.000	20	1725230000
18	86.36	3.400	20	1725240000
20	96.52	3.800	20	1725250000
22	106.68	4.200	10	1725260000
24	116.84	4.600	10	1725270000
26	60.96	2.400	10	1725280000
28	66.04	2.600	10	1725290000
30	71.12	2.800	10	1725300000
32	76.20	3.000	10	1725310000
34	81.28	3.200	10	1725320000
36	86.36	3.400	10	1725330000
38	91.44	3.600	10	1725340000
40	96.52	3.800	10	1725350000
42	101.60	4.000	10	1725360000
44	106.68	4.200	10	1725370000
46	111.76	4.400	10	1725380000
48	116.84	4.600	10	1725390000

SLD 5.08V/180



Dimensioned drawing

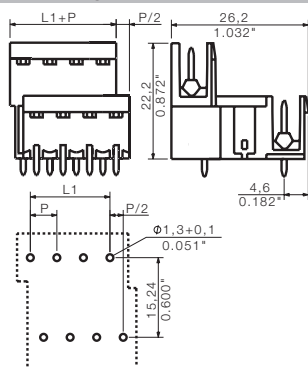

Ordering data

Solder pin length		3.2 mm		
Colour		Orange		
Pitch		5.08 mm		
Pol.	L1	(inch)	Qty.	Order No.
4	5.08	0.200	50	1725650000
6	10.16	0.400	50	1725660000
8	15.24	0.600	50	1725670000
10	45.72	1.800	50	1725680000
12	55.88	2.200	50	1725690000
14	66.04	2.600	20	1725700000
16	76.20	3.000	20	1725710000
18	86.36	3.400	20	1725720000
20	96.52	3.800	20	1725730000
22	106.68	4.200	10	1725740000
24	116.84	4.600	10	1725750000
26	60.96	2.400	10	1725760000
28	66.04	2.600	10	1725770000
30	71.12	2.800	10	1725780000
32	76.20	3.000	10	1725790000
34	81.28	3.200	10	1725800000
36	86.36	3.400	10	1725810000
38	91.44	3.600	10	1725820000
40	96.52	3.800	10	1725830000
42	101.60	4.000	10	1725840000
44	106.68	4.200	10	1725850000
46	111.76	4.400	10	1725860000
48	116.84	4.600	10	1725870000

SLD 5.08/./90 & 180

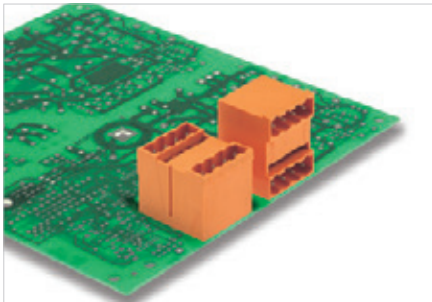

Double-level male header optimised for wave soldering. The connections are at the same level - with access that is flush over the front board. The male headers can be manually coded or ordered as pre-coded headers.

Technical data

In compliance with IEC 60664-1 / IEC 61984			
Clamping range, max.	mm ²		
Solid core H05(07) V-U	mm ²		
Stranded H07 V-R			
Flexible H05(07) V-K	mm ²		
Flexible with ferrule	mm ²		
Ferrule with plastic collar	mm ²		
Stripping length	mm		
Screwdriver blade	mm		
According to norm			
Tightening torque range	Nm		
Rated current, max.	A	11	9.5
At ambient temperature		20°C	40°C
For conductor cross-section	mm ²		
Overtolerance category		III	III II
Pollution severity		3	2 2
Rated voltage	V	250	320 400
Rated impulse voltage	kV	4	4 4
UL / CUL (Use Group)		B	C D
Rated voltage	V	300	300
Rated current	A	10	10
AWG conductor	AWG		
CSA (Use Group)		B	C D
Rated voltage	V	300	300
Rated current	A	10	10
AWG conductor	AWG		
General data			
Type of insulation material		PBT	
UL 94 flammability rating		V-0	
Contact base material		CuSn	
Material of contact surface		tinned	
Pin dimensions = d	mm	1.2, Octagonal	
Solder eyelet Ø = D	mm	1.3	
Solder eyelet Ø tolerance	mm	+ 0,1	

Product data

IEC: 400 V / 11 A
UL: 300 V / 10 A

For additional articles and information, refer to catalog.weidmueller.com

Note:

- Additional colours on request
- Rated current related to rated cross-section & min. No. of poles.
- Spacing between rows: see hole layout
- P on drawing = pitch
- Rated data refer only to the component itself. Clearance and creepage distances to other components are to be designed in accordance with the relevant application standards.

SLD 5.08/./90G



Dimensioned drawing

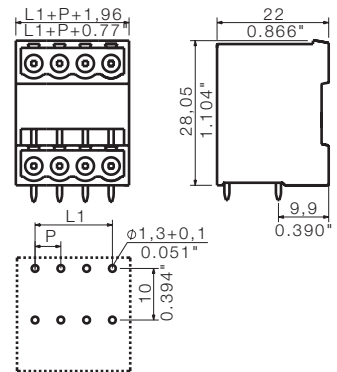

Accessories

Note: Refer to the Accessories chapter for additional accessories.

Coding	Order No.
BLZ/SL KO OR	1573010000
BLZ/SL KO SW	1545710000
Partition element	
SL AT OR	1598300000
SL AT SW	1770240000

Ordering data

Solder pin length		3.2 mm		
Colour	Orange			
Pitch	5.08 mm			
Pol.	L1	(inch)	Qty.	Order No.
4	5.08	0.200	50	1601790000
6	25.40	1.000	50	1601800000
8	35.56	1.400	50	1601810000
10	45.72	1.800	50	1601820000
12	55.88	2.200	50	1601830000
14	66.04	2.600	20	1601840000
16	76.20	3.000	20	1601850000
18	86.36	3.400	20	1601860000
20	96.52	3.800	20	1601870000
22	106.68	4.200	10	1601880000
24	116.84	4.600	10	1601890000
26	60.96	2.400	10	1601900000
28	66.04	2.600	10	1601910000
30	71.12	2.800	10	1601920000
32	76.20	3.000	10	1601930000
34	81.28	3.200	10	1601940000
36	86.36	3.400	10	1601950000
38	91.44	3.600	10	1601960000
40	96.52	3.800	10	1601970000
42	101.60	4.000	10	1601980000
44	106.68	4.200	10	1601990000
46	111.76	4.400	10	1602000000
48	116.84	4.600	10	1602010000

SLD 5.08/./180G



Dimensioned drawing

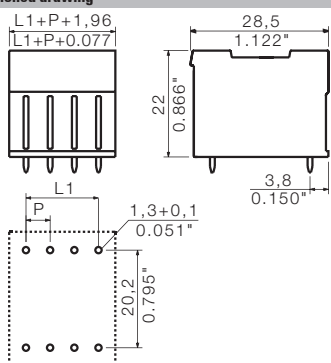

Ordering data

Solder pin length		3.2 mm		
Colour		Orange		
Pitch		5.08 mm		
Pol.	L1	(inch)	Qty.	Order No.
4	5.08	0.200	50	1602390000
6	25.40	1.000	50	1602400000
8	35.56	1.400	50	1602410000
10	45.72	1.800	50	1602420000
12	55.88	2.200	50	1602430000
14	66.04	2.600	20	1602440000
16	76.20	3.000	20	1602450000
18	86.36	3.400	20	1602460000
20	96.52	3.800	20	1602470000
22	106.68	4.200	10	1602480000
24	116.84	4.600	10	1602490000
26	60.96	2.400	10	1602500000
28	66.04	2.600	10	1602510000
30	71.12	2.800	10	1602520000
32	76.20	3.000	10	1602530000
34	81.28	3.200	10	1602540000
36	86.36	3.400	10	1602550000
38	91.44	3.600	10	1602560000
40	96.52	3.800	10	1602570000
42	101.60	4.000	10	1602580000
44	106.68	4.200	10	1602590000
46	111.76	4.400	10	1602600000
48	116.84	4.600	10	1602610000

SLDF 5.08 L/F..



Feed-through male connector with optional locking function, for mounting on front plate. Internal connection as flat-blade or solder connection. All male headers can be manually coded or ordered as pre-coded headers.

Product data

IEC: 400 V / 15 A
UL: 300 V / 10 A

For additional articles and information, refer to catalog.weidmueller.com

Note:

- Additional colours on request
- Rated current related to rated cross-section & min. No. of poles.
- Connectable cables with solder connection solid and flexible up to 2.5 mm² with insulating/shrink-wrap sleeve or from 2.8 mm flat blade receptacles with insulated sleeves acc. to DIN IEC 760
- P on drawing = pitch
- Rated data refer only to the component itself. Clearance and creepage distances to other components are to be designed in accordance with the relevant application standards.

SLDF 5.08 L/F..

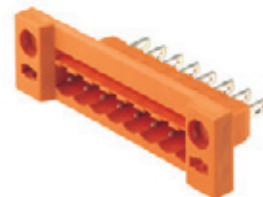

Dimensioned drawing

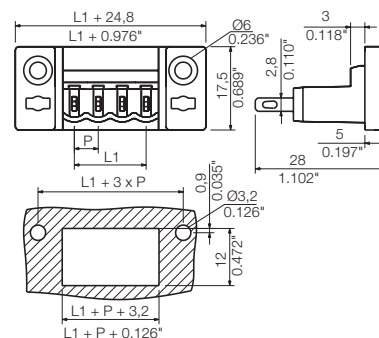

Technical data

In compliance with IEC 60664-1 / IEC 61984			
Clamping range, max.	mm ²		
Solid core H05(07) V-U	mm²		
Stranded H07 V-R			
Flexible H05(07) V-K	mm ²		
Flexible with ferrule	mm ²		
Ferrule with plastic collar	mm ²		
Stripping length	mm		
Screwdriver blade	mm		
According to norm			
Tightening torque range	Nm		
Rated current, max.	A	15	13
At ambient temperature		20°C	40°C
For conductor cross-section	mm ²		
Overvoltage category		III	III II
Pollution severity		3	2 2
Rated voltage	V	250	320 400
Rated impulse voltage	kV	4	4 4
UL / CUL (Use Group)		B	C D
Rated voltage	V	300	300
Rated current	A	10	10
AWG conductor	AWG		
CSA (Use Group)		B	C D
Rated voltage	V	300	300
Rated current	A	10	10
AWG conductor	AWG		
General data			
Type of insulation material		PBT	
UL 94 flammability rating		V-0	
Contact base material		CuSn	
Material of contact surface		tinned	
Pin dimensions = d	mm		
Solder eyelet Ø = D	mm		
Solder eyelet Ø tolerance	mm		

Accessories

Note: Refer to the Accessories chapter for additional accessories.

Coding		Order No.
	BLZ/SL KO OR	1573010000
	BLZ/SL KO SW	1545710000
Partition element		
	SL AT OR	1598300000
	SL AT SW	1770240000
Interlock		
	SLDF VR	1599120000

Ordering data

Solder pin length				
Colour	Orange			
Pitch	5.08 mm			
Pol.	L1	(inch)	Qty.	Order No.
2	5.08	0.200	100	1599130000
3	10.16	0.400	100	1599140000
4	15.24	0.600	100	1599150000
5	20.32	0.800	50	1599160000
6	25.40	1.000	50	1599170000
7	30.48	1.200	50	1599180000
8	35.56	1.400	50	1599190000
9	40.64	1.600	50	1599200000
10	45.72	1.800	50	1599210000
11	50.80	2.000	50	1599220000
12	55.88	2.200	50	1599230000
13	60.96	2.400	50	1599240000
14	66.04	2.600	50	1599250000
15	71.12	2.800	50	1599260000
16	76.20	3.000	50	1599270000

SLS 5.08../180DF

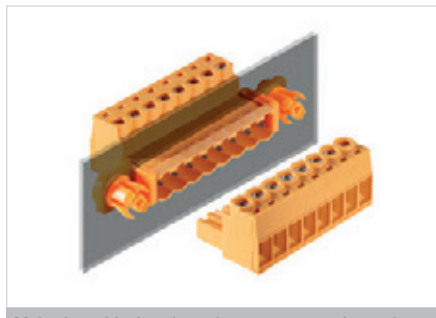

Male plug with clamping-yoke screw connection and straight wire outlet. The male plugs provide space for labelling and can be coded. Packed in a cardboard box.

- SLS 5.08 F & BLZP 5.08 F for wire-to-wire applications as wall or device feed-through
- SLS 5.08 F & BLZP 5.08 F for wire-to-wire applications / flying lead couplings
- SLS 5.08 FI & BLL 5.08 FI for board-to-wire connections (power supply for actuators)
- Folded steel clamping yoke accommodates the connected wire and compensates for temperature fluctuations

Technical data

In compliance with IEC 60664-1 / IEC 61984			
Clamping range, max.	mm ²	0.13...3.31	
Solid core H05(07) V-U	mm ²	0.2...2.5	
Stranded H07 V-R			
Flexible H05(07) V-K	mm ²	0.2...2.5	
Flexible with ferrule	mm ²	0.2...2.5	
Ferrule with plastic collar	mm ²	0.2...2.5	
Stripping length	mm	7	
Screwdriver blade	mm	0.6 x 3.5	
According to norm		DIN 5264	
Tightening torque range	Nm	0.4...0.5	
Rated current, max.	A	21.5	18
At ambient temperature		20°C	40°C
For conductor cross-section	mm ²		
Overvoltage category		III	III II
Pollution severity		3	2 2
Rated voltage	V	250	320 400
Rated impulse voltage	kV	4	4 4
UL / CUL (Use Group)		B	C D
Rated voltage	V	300	300
Rated current	A	15	10
AWG conductor	AWG	26-12	
CSA (Use Group)		B	C D
Rated voltage	V	300	300
Rated current	A	15	10
AWG conductor	AWG	26-12	
General data			
Type of insulation material		PBT	
UL 94 flammability rating		V-0	
Contact base material		CuSn	
Material of contact surface		tinned	
Pin dimensions = d	mm		
Solder eyelet Ø = D	mm		
Solder eyelet Ø tolerance	mm		

Product data

IEC: 400 V / 21.5 A / 0.2 - 2.5 mm²
UL: 300 V / 15 A / AWG 26 - 12

For additional articles and information, refer to catalog.weidmuller.com

Note:

- Additional colours on request
- Rated current related to rated cross-section & min. No. of poles.
- Wire end ferrule without plastic collar to DIN 46228/1
- Wire end ferrule with plastic collar to DIN 46228/4
- P on drawing = pitch
- Rated data refer only to the component itself. Clearance and creepage distances to other components are to be designed in accordance with the relevant application standards.

SLS 5.08../180DF



Dimensioned drawing

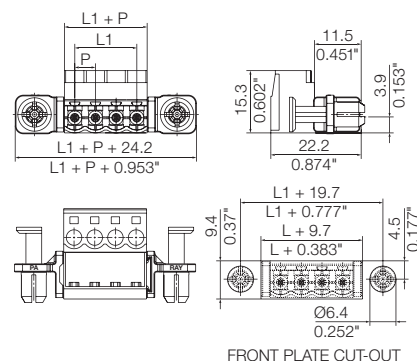

Accessories

Note: Refer to the Accessories chapter for additional accessories.

Strain relief		Order No.
	BLZ 5.08 ZE4 OR	1652110000
	BLZ 5.08 ZE4 SW	1652130000
	BLZ 5.08 ZE8 OR	1652050000
	BLZ 5.08 ZE8 SW	1652070000
Coding		
	BLZ/SL KO OR	1573010000
	BLZ/SL KO SW	1545710000
Screwdriver		
	SDIS 0.6X3.5X100	9008390000
	SDS 0.6X3.5X100	9008330000
Partition element		
	SL AT OR	1598300000
	SL AT SW	1770240000

Ordering data

Solder pin length					
Colour	Orange				
Pitch	5.08 mm				
Pol.	L1	(inch)	Qty.	Order No.	
2	5.08	0.200	54	1353470000	
3	10.16	0.400	42	1353480000	
4	15.24	0.600	42	1353490000	
5	20.32	0.800	36	1353500000	
6	25.40	1.000	30	1353520000	
7	30.48	1.200	30	1353530000	
8	35.56	1.400	24	1353540000	
9	40.64	1.600	24	1353550000	
10	45.72	1.800	24	1353570000	

Representative deratings curve

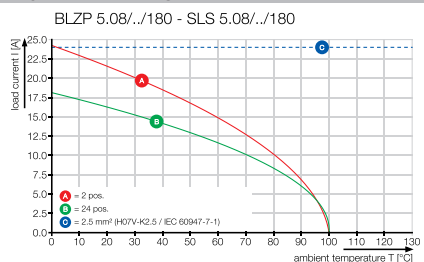

Flexibility & safety

Maximum flexibility and optimum safety should be guaranteed when designing this equipment.

This application can be made with various connection systems: a TOP connection with a screw, clamping yoke or PUSH IN. It is necessary to adapt the hole size, as appropriate, to the expanding rivets so that they are able respond to the thickness of the customers' housing wall whilst still being able to guarantee the highest level of safety. This means we strike just the right balance between easy pin insertion without using a tool and optimum stability and vibration resistance for the entire coupling during the application.

BBDF sectional drawing in the wall of the housing

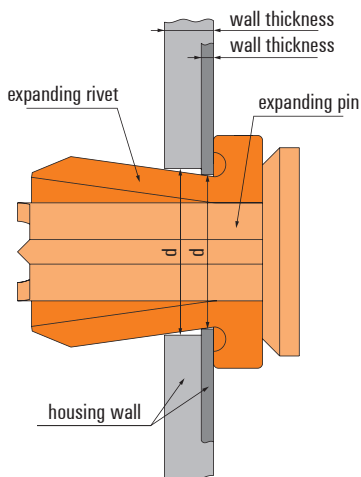

hole size table

	housing wall thickness	hole size (p)
mm	0.5 - 0.8	6.3
	1	6.4
	1.5	6.5
	2	6.7
inch	0.019 - 0.031	0.248
	0.039	0.252
	0.059	0.256
	0.079	0.264

assembly description

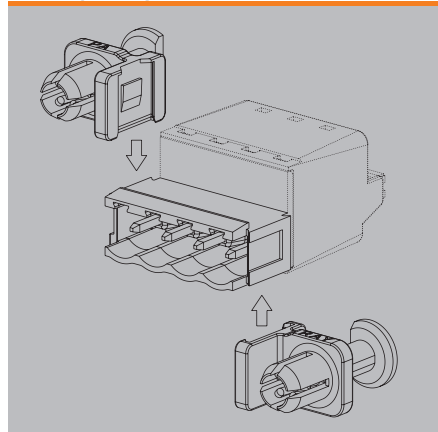

SLT 5.08/./180DF

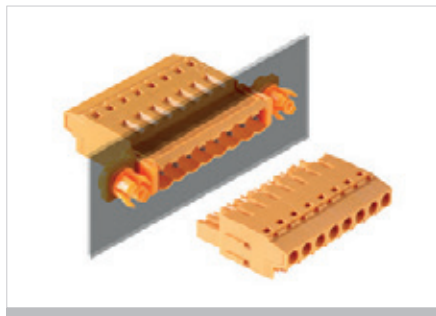

Male plug with clamping-yoke screw connection and straight wire outlet. The male plugs provide space for labelling and can be coded. Packed in a cardboard box.

- SLT 5.08 DF & BLT 5.08 for wire-to-wire applications as wall or device feed-through
- SLT 5.08 F & BLT 5.08 F for wire-to-wire applications / flying lead couplings
- SLT 5.08 FI & BLL 5.08 FI for board-to-wire connections (power supply for actuators)
- Folded steel clamping yoke accommodates the connected wire and compensates for temperature fluctuations

Technical data

In compliance with IEC 60664-1 / IEC 61984			
Clamping range, max.	mm ²	0.13...2.5	
Solid core H05(07) V-U	mm ²	0.2...2.5	
Stranded H07 V-R			
Flexible H05(07) V-K	mm ²	0.2...1.5	
Flexible with ferrule	mm ²	0.2...1.5	
Ferrule with plastic collar	mm ²	0.2...1.5	
Stripping length	mm	13	
Screwdriver blade	mm	0.6 x 3.5	
According to norm		DIN 5264	
Tightening torque range	Nm	0.4...0.5	
Rated current, max.	A	16	13
At ambient temperature		20°C	40°C
For conductor cross-section	mm ²		
Overvoltage category		III	III II
Pollution severity		3	2 2
Rated voltage	V	250	400 400
Rated impulse voltage	kV	4	4 4
UL / CUL (Use Group)		B	C D
Rated voltage	V	300	300
Rated current	A	10	10
AWG conductor	AWG	26-14	
CSA (Use Group)		B	C D
Rated voltage	V	300	300
Rated current	A	10	10
AWG conductor	AWG	26-14	
General data			
Type of insulation material		PBT	
UL 94 flammability rating		V-0	
Contact base material			
Material of contact surface			
Pin dimensions = d	mm		
Solder eyelet Ø = D	mm		
Solder eyelet Ø tolerance	mm		

Product data

IEC: 400 V / 16 A / 0.2 - 2.5 mm²
UL: 300 V / 10 A / AWG 26 - 14

For additional articles and information, refer to catalog.weidmueller.com

- Note:**
- Additional colours on request
 - Rated current related to rated cross-section & min. No. of poles.
 - Wire end ferrule without plastic collar to DIN 46228/1
 - Wire end ferrule with plastic collar to DIN 46228/4
 - Crimp form A for wire end ferrules with PZ1.5 or PZ 6/5 crimping tool are recommended for the largest cable sizes.
 - P on drawing = pitch
 - Rated data refer only to the component itself. Clearance and creepage distances to other components are to be designed in accordance with the relevant application standards.

SLT 5.08/./180DF



Dimensioned drawing

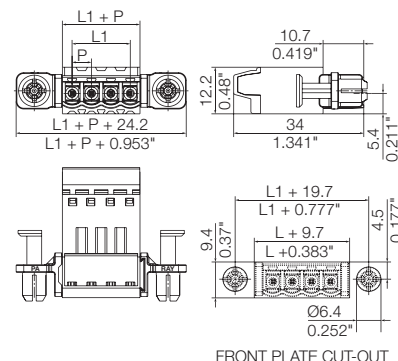

Accessories

Note: Refer to the Accessories chapter for additional accessories.

Coding	Order No.
BLZ/SL KO OR	1573010000
BLZ/SL KO SW	1545710000
Screwdriver	
SDIS 0.6X3.5X100	9008390000
SDS 0.6X3.5X100	9008330000
Partition element	
SL AT OR	1598300000
SL AT SW	1770240000

Ordering data

Solder pin length					
Colour	Orange				
Pitch	5.08 mm				
Pol.	L1	(inch)	Qty.	Order No.	
2	5.08	0.200	54	1353350000	
3	10.16	0.400	42	1353370000	
4	15.24	0.600	42	1353380000	
5	20.32	0.800	36	1353390000	
6	25.40	1.000	30	1353400000	
7	30.48	1.200	30	1353420000	
8	35.56	1.400	24	1353430000	
9	40.64	1.600	24	1353440000	
10	45.72	1.800	24	1353450000	

Flexibility & safety

Maximum flexibility and optimum safety should be guaranteed when designing this equipment.

This application can be made with various connection systems: a TOP connection with a screw, clamping yoke or PUSH IN. It is necessary to adapt the hole size, as appropriate, to the expanding rivets so that they are able respond to the thickness of the customers' housing wall whilst still being able to guarantee the highest level of safety. This means we strike just the right balance between easy pin insertion without using a tool and optimum stability and vibration resistance for the entire coupling during the application.

BBDF sectional drawing in the wall of the housing

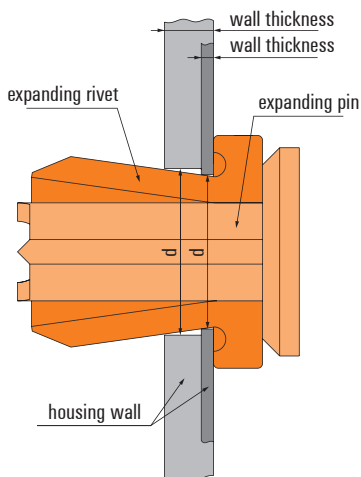

hole size table

	housing wall thickness	hole size (p)
mm	0.5 - 0.8	6.3
	1	6.4
	1.5	6.5
	2	6.7
inch	0.019 - 0.031	0.248
	0.039	0.252
	0.059	0.256
	0.079	0.264

assembly description

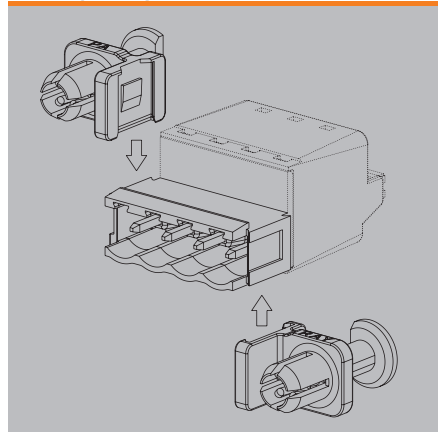

SLF 5.08/./180DF

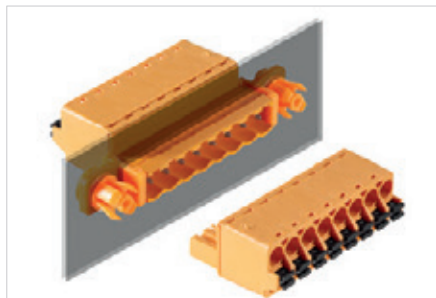

Male plug with PUSH IN wire connect with straight wire outlet. The male plugs provide space for labelling and can be coded. Packed in a cardboard box.

- SLF 5.08 DF & BLF 5.08 for wire-to-wire applications as wall or device feed-through
- SLF 5.08 F & BLF 5.08 F for wire-to-wire applications / flying lead couplings
- SLF 5.08 FI & BLL 5.08 FI for board-to-wire connections (power supply for actuators)

Technical data

In compliance with IEC 60664-1 / IEC 61984			
Clamping range, max.	mm ²	0.13...3.31	
Solid core H05(07) V-U	mm ²	0.2...2.5	
Stranded H07 V-R		0.2	
Flexible H05(07) V-K	mm ²	0.2...2.5	
Flexible with ferrule	mm ²	0.2...2.5	
Ferrule with plastic collar	mm ²	0.2...2.5	
Stripping length	mm	10	
Screwdriver blade	mm	0.6 x 3.5	
According to norm		DIN 5264	
Tightening torque range	Nm		
Rated current, max.	A	25.9	22.5
At ambient temperature		20°C	40°C
For conductor cross-section	mm ²	2.5	
Overvoltage category		III	III II
Pollution severity		3	2 2
Rated voltage	V	250	320 400
Rated impulse voltage	kV	4	4 4
UL / CUL (Use Group)		B	C D
Rated voltage	V	300	300
Rated current	A	16	16
AWG conductor	AWG	26-12	
CSA (Use Group)		B	C D
Rated voltage	V	300	300
Rated current	A	10	10
AWG conductor	AWG	26-12	
General data			
Type of insulation material		PBT	
UL 94 flammability rating		V-0	
Contact base material		CuSn	
Material of contact surface		tinned	
Pin dimensions = d	mm		
Solder eyelet Ø = D	mm		
Solder eyelet Ø tolerance	mm		

Product data

IEC: 400 V / 25.9 A / 0.2 - 2.5 mm²
UL: 300 V / 16 A / AWG 26 - 12

For additional articles and information, refer to catalog.weidmueller.com

Note:

- Additional colours on request
- Gold-plated contact surfaces on request
- Rated current related to rated cross-section & min. No. of poles.
- Wire end ferrule without plastic collar to DIN 46228/1
- Wire end ferrule with plastic collar to DIN 46228/4
- P on drawing = pitch

SLF 5.08/./180DF

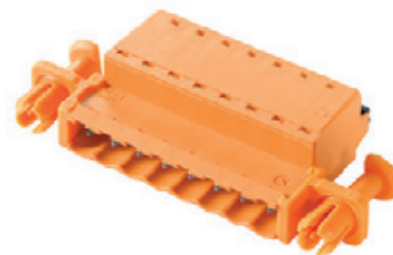

Dimensioned drawing

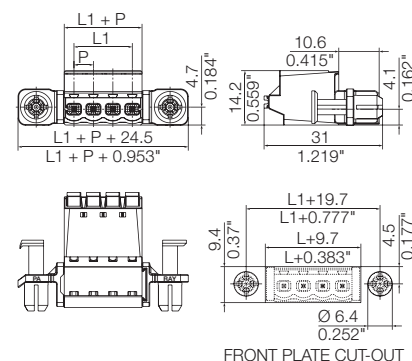

Accessories

Note: Refer to the Accessories chapter for additional accessories.

Coding		Order No.
	BLZ/SL KO OR	1573010000
	BLZ/SL KO SW	1545710000
Screwdriver		
	SDIS 0.6X3.5X100	9008390000
	SDS 0.6X3.5X100	9008330000
Wire-end ferrule		
	H0,5/14S W	9004590000
	H1,5/14S SW	9025240000
	H2,5/14S BL	1333100000

Ordering data

Solder pin length				
Colour	Orange			
Pitch	5.08 mm			
Pol.	L1	(inch)	Qty.	Order No.
2	5.08	0.200	54	1353580000
3	10.16	0.400	42	1353590000
4	15.24	0.600	42	1353600000
5	20.32	0.800	36	1353620000
6	25.40	1.000	30	1353630000
7	30.48	1.200	30	1353640000
8	35.56	1.400	24	1353650000
9	40.64	1.600	24	1353670000
10	45.72	1.800	24	1353680000

Flexibility & safety

Maximum flexibility and optimum safety should be guaranteed when designing this equipment.

This application can be made with various connection systems: a TOP connection with a screw, clamping yoke or PUSH IN. It is necessary to adapt the hole size, as appropriate, to the expanding rivets so that they are able respond to the thickness of the customers' housing wall whilst still being able to guarantee the highest level of safety. This means we strike just the right balance between easy pin insertion without using a tool and optimum stability and vibration resistance for the entire coupling during the application.

BBDF sectional drawing in the wall of the housing

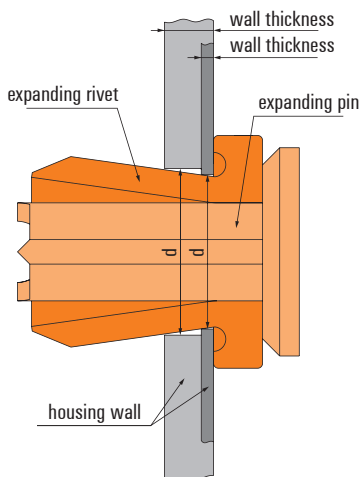

hole size table

	housing wall thickness	hole size (p)
mm	0.5 - 0.8	6.3
	1	6.4
	1.5	6.5
	2	6.7
inch	0.019 - 0.031	0.248
	0.039	0.252
	0.059	0.256
	0.079	0.264

assembly description

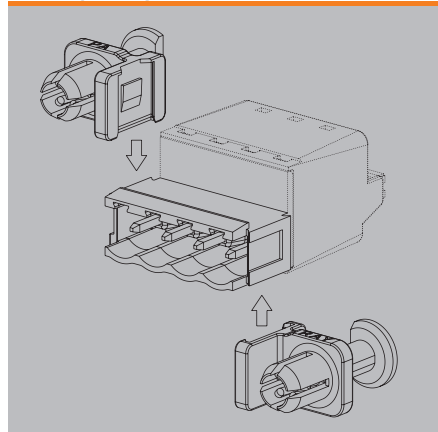

SLS 5.08../180

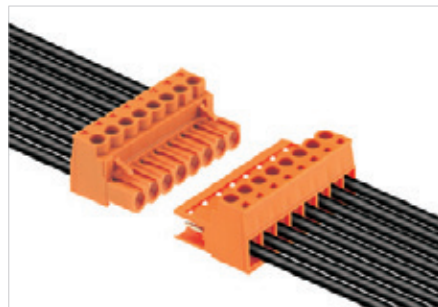

Male plug with clamping-yoke screw connection and straight wire outlet. The male plug provides space for labelling and can be coded.

- SLS 5.08 F & BLZP 5.08 F for wire-to-wire applications.
- SLS 5.08 FI & BLL 5.08 FI for board-to-wire connections.
- Folded steel clamping yoke accommodates the connected wire and compensates for temperature fluctuations
- Available in standard, with flange receptacle (F) or with screw flange (FI).

Technical data

In compliance with IEC 60664-1 / IEC 61984			
Clamping range, max.	mm ²	0.13...3.31	
Solid core H05(07) V-U	mm²	0.2...2.5	
Stranded H07 V-R			
Flexible H05(07) V-K	mm ²	0.2...2.5	
Flexible with ferrule	mm ²	0.2...2.5	
Ferrule with plastic collar	mm ²	0.2...2.5	
Stripping length	mm	7	
Screwdriver blade	mm		
According to norm			
Tightening torque range	Nm	0.4...0.5	
Rated current, max.	A	21.5	18
At ambient temperature		20°C	40°C
For conductor cross-section	mm ²		
Overvoltage category		III	III II
Pollution severity		3	2 2
Rated voltage	V	250	320 400
Rated impulse voltage	kV	4	4 4
UL / CUL (Use Group)	B C D	B	C D
Rated voltage	V	300	300
Rated current	A	15	10
AWG conductor	AWG	26-12	
CSA (Use Group)	B C D	B	C D
Rated voltage	V	300	300
Rated current	A	15	10
AWG conductor	AWG	26-12	
General data			
Type of insulation material		PBT	
UL 94 flammability rating		V-0	
Contact base material		CuSn	
Material of contact surface		tinned	
Pin dimensions = d	mm		
Solder eyelet Ø = D	mm		
Solder eyelet Ø tolerance	mm		

Product data

IEC: 400 V / 21.5 A / 0.2 - 2.5 mm²
UL: 300 V / 15 A / AWG 26 - 12

For additional articles and information, refer to catalog.weidmueller.com

- Note:**
- Additional colours on request
 - Rated current related to rated cross-section & min. No. of poles.
 - Wire end ferrule without plastic collar to DIN 46228/1
 - Wire end ferrule with plastic collar to DIN 46228/4
 - P on drawing = pitch
 - Rated data refer only to the component itself. Clearance and creepage distances to other components are to be designed in accordance with the relevant application standards.

SLS 5.08../180B



Dimensioned drawing

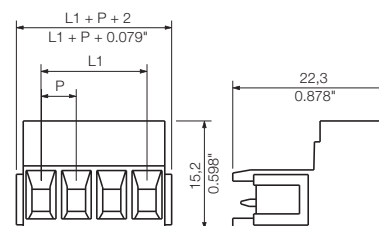

Accessories

Note: Refer to the Accessories chapter for additional accessories.

Strain relief		Order No.
	BLZ 5.08 ZE4 OR	1652110000
	BLZ 5.08 ZE4 SW	1652130000
	BLZ 5.08 ZE8 OR	1652050000
	BLZ 5.08 ZE8 SW	1652070000
Coding		
	BLZ/SL KO OR	1573010000
	BLZ/SL KO SW	1545710000
Screwdriver		
	SDIS 0.6X3.5X100	9008390000
	SDS 0.6X3.5X100	9008330000
Partition element		
	SL AT OR	1598300000
	SL AT SW	1770240000
Mounting block		
	SLA BB11R OR	1604120000
	SLA BB11R SW	1692340000

Ordering data

Solder pin length					
Colour	Orange				
Pitch	5.08 mm				
Pol.	L1	(inch)	Qty.	Order No.	
2	5.08	0.200	100	1627240000	
3	10.16	0.400	100	1627250000	
4	15.24	0.600	100	1627260000	
5	20.32	0.800	50	1627270000	
6	25.40	1.000	50	1627280000	
7	30.48	1.200	50	1627290000	
8	35.56	1.400	50	1627300000	
9	40.64	1.600	50	1627310000	
10	45.72	1.800	50	1627320000	
11	50.80	2.000	50	1627330000	
12	55.88	2.200	50	1627340000	
13	60.96	2.400	50	1627350000	
14	66.04	2.600	50	1627360000	
15	71.12	2.800	50	1627370000	
16	76.20	3.000	50	1627380000	
17	81.28	3.200	20	1645150000	
18	86.36	3.400	20	1645160000	
19	91.44	3.600	20	1645170000	
20	96.52	3.800	20	1645180000	
21	101.60	4.000	20	1645190000	
22	106.68	4.200	20	1645200000	
23	111.76	4.400	20	1645210000	
24	116.84	4.600	20	1645220000	

Representative deratings curve

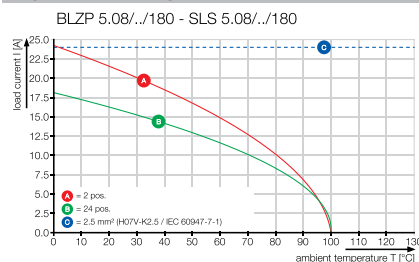

SLS 5.08../180F



Dimensioned drawing

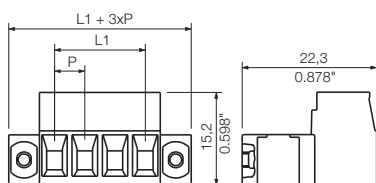

SLS 5.08../180FI



Dimensioned drawing

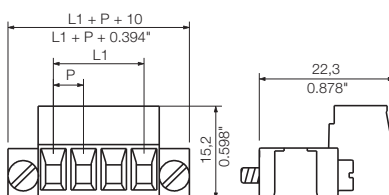

Ordering data

Solder pin length					
Colour					Orange
Pitch 5.08 mm					
Pol.	L1	(inch)	Qty.	Order No.	
2	5.08	0.200	100	1846360000	
3	10.16	0.400	100	1846370000	
4	15.24	0.600	100	1846380000	
5	20.32	0.800	50	1846390000	
6	25.40	1.000	50	1846400000	
7	30.48	1.200	50	1846410000	
8	35.56	1.400	50	1846420000	
9	40.64	1.600	50	1846430000	
10	45.72	1.800	50	1846440000	
11	50.80	2.000	50	1846450000	
12	55.88	2.200	50	1846460000	
13	60.96	2.400	50	1846470000	
14	66.04	2.600	50	1846480000	
15	71.12	2.800	50	1846490000	
16	76.20	3.000	50	1846500000	

Ordering data

Solder pin length					
Colour					Orange
Pitch 5.08 mm					
Pol.	L1	(inch)	Qty.	Order No.	
2	5.08	0.200	100	1846210000	
3	10.16	0.400	100	1846220000	
4	15.24	0.600	100	1846230000	
5	20.32	0.800	50	1846240000	
6	25.40	1.000	50	1846250000	
7	30.48	1.200	50	1846260000	
8	35.56	1.400	50	1846270000	
9	40.64	1.600	50	1846280000	
10	45.72	1.800	50	1846290000	
11	50.80	2.000	50	1846300000	
12	55.88	2.200	50	1846310000	
13	60.96	2.400	50	1846320000	
14	66.04	2.600	50	1846330000	
15	71.12	2.800	50	1846340000	
16	76.20	3.000	50	1846350000	

Additional deratings curves

BLZP 5.08../180 - SLS 5.08../180

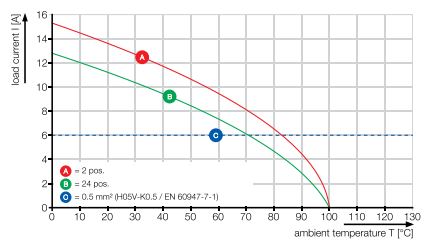

BLL 5.08../180 - SLS 5.08../180

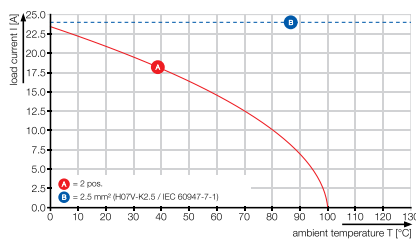

SLS 5.08../180TB RF15



Male plug with clamping-yoke screw connection and straight wire outlet. The male plug provides space for labelling and can be coded.

- The clip-on foot makes it easy to attach to the DIN rail (TS15).
- SLS 5.08 F & BLZP 5.08 F for wire-to-wire applications (flying lead assemblies)
- Folded steel clamping yoke accommodates the connected wire and compensates for temperature fluctuations

Product data

IEC: 400 V / 21.5 A / 0.2 - 2.5 mm²
UL: 300 V / 15 A / AWG 26 - 12

For additional articles and information, refer to catalog.weidmueller.com

Note:

- Additional colours on request
- Rated current related to rated cross-section & min. No. of poles.
- Wire end ferrule without plastic collar to DIN 46228/1
- Wire end ferrule with plastic collar to DIN 46228/4
- P on drawing = pitch
- Rated data refer only to the component itself. Clearance and creepage distances to other components are to be designed in accordance with the relevant application standards.

SLS 5.08../180TB RF15



Dimensioned drawing

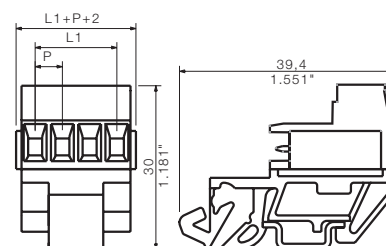

Technical data

In compliance with IEC 60664-1 / IEC 61984			
Clamping range, max.	mm ²	0.13...3.31	
Solid core H05(07) V-U	mm²	0.2...2.5	
Stranded H07 V-R			
Flexible H05(07) V-K	mm ²	0.2...2.5	
Flexible with ferrule	mm ²	0.2...2.5	
Ferrule with plastic collar	mm ²	0.2...2.5	
Stripping length	mm	7	
Screwdriver blade	mm	0.6 x 3.5	
According to norm		DIN 5264	
Tightening torque range	Nm	0.4...0.5	
Rated current, max.	A	21.5	18
At ambient temperature		20°C	40°C
For conductor cross-section	mm ²		
Overvoltage category		III	III II
Pollution severity		3	2 2
Rated voltage	V	250	320 400
Rated impulse voltage	kV	4	4 4
UL / CUL (Use Group)		B	C D
Rated voltage	V	300	300
Rated current	A	15	10
AWG conductor	AWG	26-12	
CSA (Use Group)		B	C D
Rated voltage	V	300	300
Rated current	A	15	10
AWG conductor	AWG	26-12	
General data			
Type of insulation material		PBT	
UL 94 flammability rating		V-0	
Contact base material		CuSn	
Material of contact surface		tinned	
Pin dimensions = d	mm		
Solder eyelet Ø = D	mm		
Solder eyelet Ø tolerance	mm		

Accessories

Note: Refer to the Accessories chapter for additional accessories.

Coding	Order No.
BLZ/SL KO OR	1573010000
BLZ/SL KO SW	1545710000
Screwdriver	
SDIS 0.6X3.5X100	9008390000
SDS 0.6X3.5X100	9008330000
Partition element	
SL AT OR	1598300000
SL AT SW	1770240000
Mounting block	
SLA BB4 OR	1571720000
SLA BB8 RH OR	1446060000

Ordering data

Solder pin length				
Colour	Orange			
Pitch	5.08 mm			
Pol.	L1	(inch)	Qty.	Order No.
4	15.24	0.600	20	1846050000
6	25.40	1.000	20	1846060000
8	35.56	1.400	10	1846070000
10	45.72	1.800	10	1846080000
12	55.88	2.200	10	1846090000
16	76.20	3.000	5	1846100000
20	96.52	3.800	5	1846110000
24	116.84	4.600	5	1846120000

Representative deratings curve

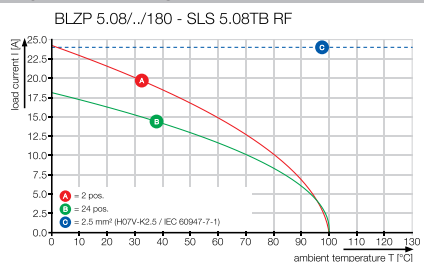

SLS 5.08../180TB KF35

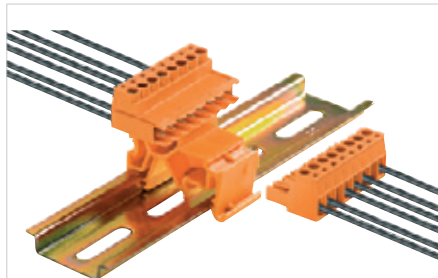

Male plug with clamping-yoke screw connection and straight wire outlet. The male plug provides space for labelling and can be coded.

- The clip-on foot makes it easy to attach to the DIN rail (TS32 / TS35).
- SLS 5.08 F & BLZP 5.08 F for wire-to-wire applications (flying lead assemblies)
- Folded steel clamping yoke accommodates the connected wire and compensates for temperature fluctuations

Technical data

In compliance with IEC 60664-1 / IEC 61984			
Clamping range, max.	mm ²	0.13...3.31	
Solid core H05(07) V-U	mm ²	0.2...2.5	
Stranded H07 V-R			
Flexible H05(07) V-K	mm ²	0.2...2.5	
Flexible with ferrule	mm ²	0.2...2.5	
Ferrule with plastic collar	mm ²	0.2...2.5	
Stripping length	mm	7	
Screwdriver blade	mm	0.6 x 3.5	
According to norm		DIN 5264	
Tightening torque range	Nm	0.4...0.5	
Rated current, max.	A	21.5	18
At ambient temperature		20°C	40°C
For conductor cross-section	mm ²		
Overvoltage category		III	III II
Pollution severity		3	2 2
Rated voltage	V	250	320 400
Rated impulse voltage	kV	4	4 4
UL / CUL (Use Group)		B	C D
Rated voltage	V	300	300
Rated current	A	15	10
AWG conductor	AWG	26-12	
CSA (Use Group)		B	C D
Rated voltage	V	300	300
Rated current	A	15	10
AWG conductor	AWG	26-12	
General data			
Type of insulation material		PBT	
UL 94 flammability rating		V-0	
Contact base material		CuSn	
Material of contact surface		tinned	
Pin dimensions = d	mm		
Solder eyelet Ø = D	mm		
Solder eyelet Ø tolerance	mm		

Product data

IEC: 400 V / 21.5 A / 0.2 - 2.5 mm²
UL: 300 V / 15 A / AWG 26 - 12

For additional articles and information, refer to catalog.weidmueller.com

Note:

- Additional colours on request
- Rated current related to rated cross-section & min. No. of poles.
- Wire end ferrule without plastic collar to DIN 46228/1
- Wire end ferrule with plastic collar to DIN 46228/4
- P on drawing = pitch
- Rated data refer only to the component itself. Clearance and creepage distances to other components are to be designed in accordance with the relevant application standards.

SLS 5.08../180TB KF35



Dimensioned drawing

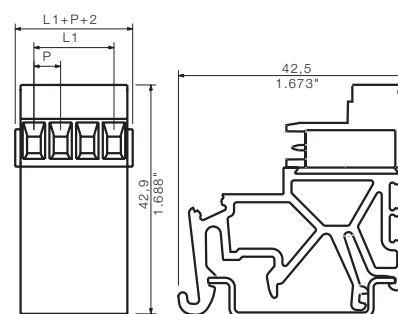

Accessories

Note: Refer to the Accessories chapter for additional accessories.

Coding	Order No.
BLZ/SL KO OR	1573010000
BLZ/SL KO SW	1545710000
Screwdriver	
SDIS 0.6X3.5X100	9008390000
SDS 0.6X3.5X100	9008330000
Partition element	
SL AT OR	1598300000
SL AT SW	1770240000
Mounting block	
SLA BB4 OR	1571720000
SLA BB8 RH OR	1446060000

Ordering data

Solder pin length					
Colour	Orange				
Pitch	5.08 mm				
Pol.	L1	(inch)	Qty.	Order No.	
4	15.24	0.600	20	1846130000	
6	25.40	1.000	20	1846140000	
8	35.56	1.400	10	1846150000	
10	45.72	1.800	10	1846160000	
12	55.88	2.200	10	1846170000	
16	76.20	3.000	5	1846180000	
20	96.52	3.800	5	1846190000	
24	116.84	4.600	5	1846200000	

Representative deratings curve



SLT 5.08/./180B

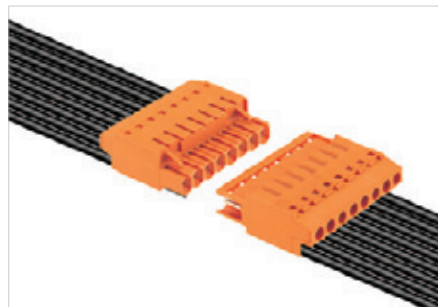

Male plug with TOP screw connection, with straight wire outlet. The male plug provides space for labelling and can be coded.

- SLT 5.08 & BLT 5.08 for wire-to-wire applications (flying lead assemblies)
- SLT 5.08 & BLL 5.08 for board-to-board connections (e.g., power supply for actuators)
- The specialist for cramped installations
- The extra flat shape allows for dense component assembly.
- The screw connect and the cable entry are located on the same side of the connector.

Product data

IEC: 400 V / 16 A / 0.2 - 2.5 mm²
UL: 300 V / 10 A / AWG 26 - 14

For additional articles and information, refer to catalog.weidmueller.com

Note:

- Additional colours on request
- Rated current related to rated cross-section & min. No. of poles.
- Wire end ferrule without plastic collar to DIN 46228/1
- Wire end ferrule with plastic collar to DIN 46228/4
- Crimp form A for wire end ferrules with PZ 6/5 crimping tool are recommended for the largest cable sizes.
- P on drawing = pitch
- Rated data refer only to the component itself. Clearance and creepage distances to other components are to be designed in accordance with the relevant application standards.

SLT 5.08/./180B



Dimensioned drawing

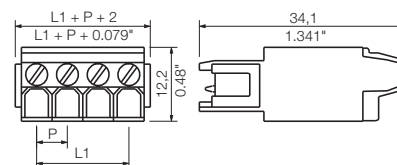









Technical data

In compliance with IEC 60664-1 / IEC 61984			
Clamping range, max.	mm ²	0.13...2.5	
Solid core H05(07) V-U	mm²	0.2...2.5	
Stranded H07 V-R			
Flexible H05(07) V-K	mm ²	0.2...1.5	
Flexible with ferrule	mm ²	0.2...1.5	
Ferrule with plastic collar	mm ²	0.2...1.5	
Stripping length	mm	13	
Screwdriver blade	mm	0.6 x 3.5	
According to norm		DIN 5264	
Tightening torque range	Nm	0.4...0.5	
Rated current, max.	A	16	13
At ambient temperature	20°C	40°C	
For conductor cross-section	mm ²		
Overvoltage category		III	II
Pollution severity		3	2
Rated voltage	V	250	400
Rated impulse voltage	kV	4	4
UL / CUL (Use Group)		B	C
Rated voltage	V	300	300
Rated current	A	10	10
AWG conductor	AWG	26-14	
CSA (Use Group)		B	C
Rated voltage	V	300	300
Rated current	A	10	10
AWG conductor	AWG	26-14	
General data			
Type of insulation material		PBT	
UL 94 flammability rating		V-0	
Contact base material		CuSn	
Material of contact surface		tinned	
Pin dimensions = d	mm		
Solder eyelet Ø = D	mm		
Solder eyelet Ø tolerance	mm		

Accessories

Note: Refer to the Accessories chapter for additional accessories.

Coding	Order No.
 BLZ/SL KO OR	1573010000
 BLZ/SL KO SW	1545710000
Screwdriver	
 SDIS 0.6X3.5X100	9008390000
 SDS 0.6X3.5X100	9008330000
Partition element	
 SL AT OR	1598300000
 SL AT SW	1770240000
Mounting block	
 SLA BB11R OR	1604120000
 SLA BB11R SW	1692340000

Ordering data

Solder pin length					
Colour	Orange				
Pitch	5.08 mm				
Pol.	L1	(inch)	Qty.	Order No.	
2	5.08	0.200	100	1611710000	
3	10.16	0.400	100	1611720000	
4	15.24	0.600	100	1611730000	
5	20.32	0.800	50	1611740000	
6	25.40	1.000	50	1611750000	
7	30.48	1.200	50	1611760000	
8	35.56	1.400	50	1611770000	
9	40.64	1.600	50	1611780000	
10	45.72	1.800	50	1611790000	
11	50.80	2.000	50	1611800000	
12	55.88	2.200	50	1611810000	
13	60.96	2.400	50	1611820000	
14	66.04	2.600	50	1611830000	
15	71.12	2.800	50	1611840000	
16	76.20	3.000	50	1611850000	

Representative deratings curve

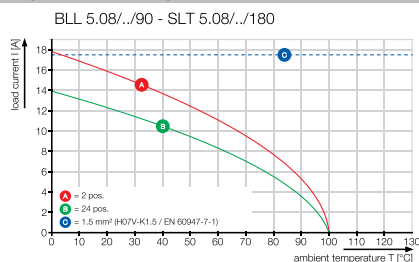

SLF 5.08



Male plug with PUSH IN wire connect with straight wire outlet. The male plugs provide space for labelling and can be coded. Packed in a cardboard box.

- SLF 5.08 DF & BLF 5.08 for wire-to-wire applications as wall or device feed-through
- SLF 5.08 F & BLF 5.08 F for wire-to-wire applications / flying lead couplings
- SLF 5.08 FI & BLF 5.08 FI for board-to-wire connections (power supply for actuators)

Technical data

In compliance with IEC 60664-1 / IEC 61984			
Clamping range, max.	mm ²	0.13...3.31	
Solid core H05(07) V-U	mm ²	0.2...2.5	
Stranded H07 V-R		0.2	
Flexible H05(07) V-K	mm ²	0.2...2.5	
Flexible with ferrule	mm ²	0.2...2.5	
Ferrule with plastic collar	mm ²	0.2...2.5	
Stripping length	mm	10	
Screwdriver blade	mm	0.6 x 3.5	
According to norm			
Tightening torque range	Nm		
Rated current, max.	A	25.9	22.5
At ambient temperature		20°C	40°C
For conductor cross-section	mm ²	2.5	
Overvoltage category		III	III II
Pollution severity		3	2 2
Rated voltage	V	250	320 400
Rated impulse voltage	kV	4	4 4
UL / CUL (Use Group)		B	C D
Rated voltage	V	300	300
Rated current	A	16	16
AWG conductor	AWG	26-12	
CSA (Use Group)		B	C D
Rated voltage	V	300	300
Rated current	A	10	10
AWG conductor	AWG	26-12	
General data			
Type of insulation material		PBT	
UL 94 flammability rating		V-0	
Contact base material		CuSn	
Material of contact surface		tinned	
Pin dimensions = d	mm		
Solder eyelet Ø = D	mm		
Solder eyelet Ø tolerance	mm		

Product data

IEC: 400 V / 25.9 A / 0.2 - 2.5 mm²
UL: 300 V / 16 A / AWG 26 - 12

For additional articles and information, refer to catalog.weidmueller.com

- Note:**
- Additional colours on request
 - Gold-plated contact surfaces on request
 - Rated current related to rated cross-section & min. No. of poles.
 - Wire end ferrule without plastic collar to DIN 46228/1
 - Wire end ferrule with plastic collar to DIN 46228/4
 - P on drawing = pitch

SLF 5.08../180



Dimensioned drawing

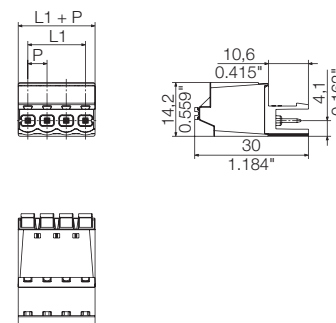

Accessories

Note: Refer to the Accessories chapter for additional accessories.

Coding		Order No.
	BLZ/SL KO OR	1573010000
	BLZ/SL KO SW	1545710000
Screwdriver		
	SDIS 0.6X3.5X100	9008390000
	SDS 0.6X3.5X100	9008330000
Wire-end ferrule		
	H0,5/14S W	9004590000
	H1,0/14S R	9018560000
	H1,5/14S SW	9025240000
	H2,5/14S BL	1333100000

Ordering data

Solder pin length						
Colour	Orange		Black			
Pitch	5.08 mm					
Pol.	L1	(inch)	Qty.	Order No.	Order No.	
2	5.08	0.200	180	1335330000	1335560000	
3	10.16	0.400	120	1335340000	1335570000	
4	15.24	0.600	90	1335350000	1335580000	
5	20.32	0.800	72	1335360000	1335610000	
6	25.40	1.000	60	1335370000	1335630000	
7	30.48	1.200	48	1335380000	1335650000	
8	35.56	1.400	42	1335390000	1335670000	
9	40.64	1.600	36	1335400000	1335690000	
10	45.72	1.800	36	1335410000	1335710000	
11	50.80	2.000	30	1335420000	1335730000	
12	55.88	2.200	30	1335430000	1335750000	

SLF 5.08../180B



Dimensioned drawing

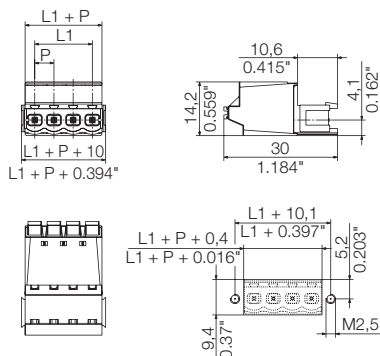

Ordering data

Solder pin length					
Colour		Orange	Black		
Pitch	5.08 mm				
Pol.	L1	(inch)	Qty.	Order No.	Order No.
2	5.08	0.200	150	1335440000	1335770000
3	10.16	0.400	108	1335450000	1335790000
4	15.24	0.600	78	1335460000	1335810000
5	20.32	0.800	66	1335470000	1335830000
6	25.40	1.000	54	1335480000	1335850000
7	30.48	1.200	48	1335490000	1335880000
8	35.56	1.400	42	1335510000	1335900000
9	40.64	1.600	36	1335520000	1335920000
10	45.72	1.800	30	1335530000	1335940000
11	50.80	2.000	30	1335540000	1335970000
12	55.88	2.200	24	1335550000	1335990000

SLF 5.08../180F



Dimensioned drawing

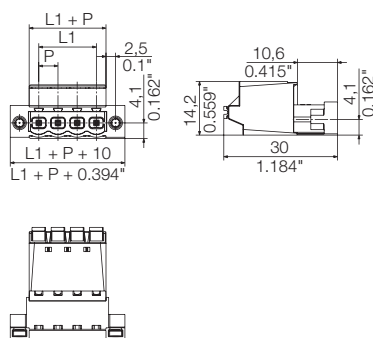

Ordering data

Solder pin length					
Colour		Orange	Black		
Pitch	5.08 mm				
Pol.	L1	(inch)	Qty.	Order No.	Order No.
2	5.08	0.200	90	1335590000	1336170000
3	10.16	0.400	72	1335620000	1336180000
4	15.24	0.600	60	1335640000	1336190000
5	20.32	0.800	54	1335660000	1336200000
6	25.40	1.000	42	1335680000	1336210000
7	30.48	1.200	42	1335700000	1336220000
8	35.56	1.400	36	1335720000	1336230000
9	40.64	1.600	30	1335740000	1336240000
10	45.72	1.800	30	1335760000	1336250000
11	50.80	2.000	24	1335780000	1336270000
12	55.88	2.200	24	1335800000	1336280000

SLF 5.08../180FI

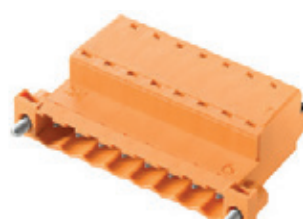

Dimensioned drawing

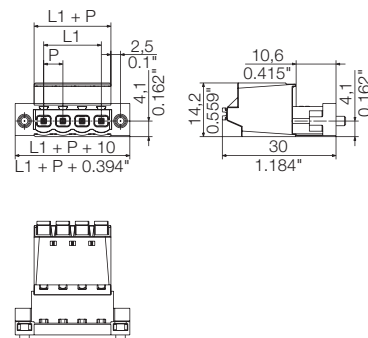

Ordering data

Solder pin length					
Colour		Orange	Black		
Pitch	5.08 mm				
Pol.	L1	(inch)	Qty.	Order No.	Order No.
2	5.08	0.200	90	1336400000	1336040000
3	10.16	0.400	72	1336410000	1336050000
4	15.24	0.600	60	1336420000	1336070000
5	20.32	0.800	54	1336430000	1336080000
6	25.40	1.000	42	1336440000	1336090000
7	30.48	1.200	42	1336450000	1336100000
8	35.56	1.400	36	1336470000	1336110000
9	40.64	1.600	30	1336480000	1336120000
10	45.72	1.800	30	1336490000	1336130000
11	50.80	2.000	24	1336500000	1336140000
12	55.88	2.200	24	1336510000	1336150000

BLZP 5.08/./180

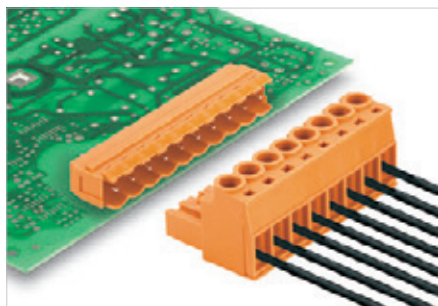

The BLZP is the functional extension of the BLZ series. The „P“ in the part name stands for a plus in security and performance in processing and use.

- WIRE READY - delivered with terminal points already opened
- Power tools can be used with the globally compatible plus/minus screw head
- Folded steel clamping yoke accommodates the connected wire and compensates for temperature fluctuations
- The integrated wire guard prevents dangerous under-insertion of the wire from occurring.
- Lock and release-lever: tool-less locking and gentle releasing of the connector reduces the mechanical stress on the solder joints.

Product data

IEC: 400 V / 19 A / 0.2 - 4 mm²
UL: 300 V / 15 A / AWG 30 - 12

For additional articles and information, refer to catalog.weidmueller.com

Note:

- Additional colours on request
- Rated current related to rated cross-section & min. No. of poles.
- Wire end ferrule without plastic collar to DIN 46228/1
- Wire end ferrule with plastic collar to DIN 46228/4
- P on drawing = pitch
- Rated data refer only to the component itself. Clearance and creepage distances to other components are to be designed in accordance with the relevant application standards.

BLZP 5.08/./180



Dimensioned drawing

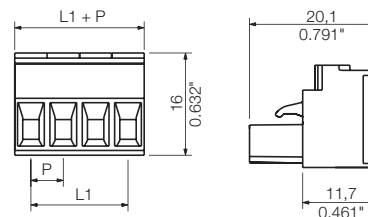

Technical data

In compliance with IEC 60664-1 / IEC 61984		
Clamping range, max.	mm ²	0.13...4
Solid core H05(07) V-U	mm²	0.2...4
Stranded H07 V-R		
Flexible H05(07) V-K	mm ²	0.2...4
Flexible with ferrule	mm ²	0.2...4
Ferrule with plastic collar	mm ²	0.2...2.5
Stripping length	mm	7
Screwdriver blade	mm	0.6 x 3.5, PH 0, PZ 0
According to norm		
Tightening torque range	Nm	0.4...0.5
Rated current, max.	A	19 16
At ambient temperature		20°C 40°C
For conductor cross-section	mm ²	4
Overvoltage category		III III II
Pollution severity		3 2 2
Rated voltage	V	250 320 400
Rated impulse voltage	kV	4 4 4
UL / CUL (Use Group)	B C D	D
Rated voltage	V	300 300
Rated current	A	15 10
AWG conductor	AWG	30-12
CSA (Use Group)	B C D	D
Rated voltage	V	300 50 300
Rated current	A	10 10 10
AWG conductor	AWG	30-12
General data		
Type of insulation material		PBT
UL 94 flammability rating		V-0
Contact base material		Copper alloy
Material of contact surface		tinned
Pin dimensions = d	mm	
Solder eyelet Ø = D	mm	
Solder eyelet Ø tolerance	mm	

Accessories

Note: Refer to the Accessories chapter for additional accessories.

Strain relief		Order No.
	BLZ 5.08 ZE4 OR	1652110000
	BLZ 5.08 ZE4 SW	1652130000
	BLZ 5.08 ZE8 OR	1652050000
	BLZ 5.08 ZE8 SW	1652070000
	BLZ/SL KO OR	1573010000
	BLZ/SL KO SW	1545710000
	SDIS 0.6X3.5X100	9008390000
	SDS 0.6X3.5X100	9008330000
	SDK PH1	9008480000
	SDK PZ1	9008530000

Ordering data

Solder pin length						
Colour	Orange		Black			
Pitch 5.08 mm						
Pol.	L1	(inch)	Qty.	Order No.	Order No.	
2	5.08	0.200	100	1943580000	1943810000	
3	10.16	0.400	100	1943590000	1943820000	
4	15.24	0.600	100	1943600000	1943830000	
5	20.32	0.800	45	1943610000	1943840000	
6	25.40	1.000	45	1943620000	1943850000	
7	30.48	1.200	45	1943630000	1943860000	
8	35.56	1.400	45	1943640000	1943870000	
9	40.64	1.600	45	1943650000	1943880000	
10	45.72	1.800	45	1943660000	1943890000	
11	50.80	2.000	36	1943670000	1943900000	
12	55.88	2.200	36	1943680000	1943910000	
13	60.96	2.400	36	1943690000	1943920000	
14	66.04	2.600	27	1943700000	1943930000	
15	71.12	2.800	27	1943710000	1943940000	
16	76.20	3.000	27	1943720000	1943950000	
17	81.28	3.200	18	1943730000	1943960000	
18	86.36	3.400	18	1943740000	1943970000	
19	91.44	3.600	18	1943750000	1943980000	
20	96.52	3.800	18	1943760000	1943990000	
21	101.60	4.000	18	1943770000	1944000000	
22	106.68	4.200	18	1943780000	1944010000	
23	111.76	4.400	18	1943790000	1944020000	
24	116.84	4.600	18	1943800000	1944030000	

Representative deratings curve

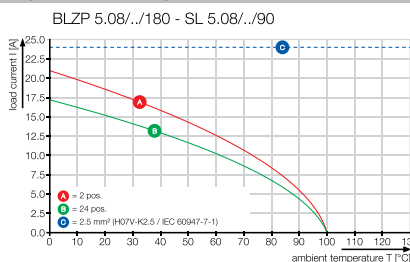

BLZP 5.08/./180F



Dimensioned drawing

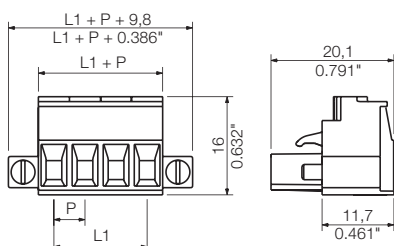

Ordering data

Solder pin length					
Colour	Orange	Black			
Pitch	5.08 mm				
Pol.	L1 (inch)	Qty.	Order No.	Order No.	
2	5.08	0.200	90	1944090000	1944330000
3	10.16	0.400	72	1944100000	1944340000
4	15.24	0.600	60	1944110000	1944350000
5	20.32	0.800	48	1944120000	1944360000
6	25.40	1.000	42	1944130000	1944370000
7	30.48	1.200	36	1944140000	1944380000
8	35.56	1.400	36	1944150000	1944390000
9	40.64	1.600	30	1944160000	1944400000
10	45.72	1.800	30	1944170000	1944410000
11	50.80	2.000	24	1944180000	1944420000
12	55.88	2.200	24	1944190000	1944430000
13	60.96	2.400	24	1944200000	1944440000
14	66.04	2.600	18	1944210000	1944450000
15	71.12	2.800	18	1944220000	1944460000
16	76.20	3.000	18	1944230000	1944470000
17	81.28	3.200	18	1944240000	1944480000
18	86.36	3.400	18	1944250000	1944490000
19	91.44	3.600	12	1944260000	1944500000
20	96.52	3.800	12	1944270000	1944510000
21	101.60	4.000	12	1944280000	1944520000
22	106.68	4.200	12	1944290000	1944530000
23	111.76	4.400	12	1944300000	1944540000
24	116.84	4.600	12	1944310000	1944550000

BLZP 5.08/./180LR

with release latch



Dimensioned drawing

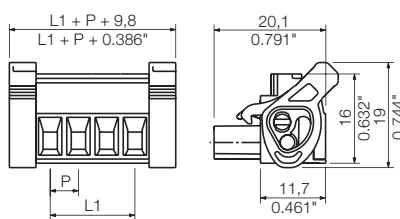

Ordering data

Solder pin length					
Colour	Orange	Black			
Pitch	5.08 mm				
Pol.	L1 (inch)	Qty.	Order No.	Order No.	
2	5.08	0.200	90	1944830000	1945060000
3	10.16	0.400	72	1944840000	1945070000
4	15.24	0.600	60	1944850000	1945080000
5	20.32	0.800	48	1944860000	1945090000
6	25.40	1.000	42	1944870000	1945100000
7	30.48	1.200	36	1944880000	1945110000
8	35.56	1.400	36	1944890000	1945120000
9	40.64	1.600	30	1944900000	1945130000
10	45.72	1.800	30	1944910000	1945140000
11	50.80	2.000	24	1944920000	1945150000
12	55.88	2.200	24	1944930000	1945160000
13	60.96	2.400	24	1944940000	1945170000
14	66.04	2.600	18	1944950000	1945180000
15	71.12	2.800	18	1944960000	1945190000
16	76.20	3.000	18	1944970000	1945200000
17	81.28	3.200	18	1944980000	1945210000
18	86.36	3.400	18	1944990000	1945220000
19	91.44	3.600	12	1945000000	1945230000
20	96.52	3.800	12	1945010000	1945240000
21	101.60	4.000	12	1945020000	1945250000
22	106.68	4.200	12	1945030000	1945260000
23	111.76	4.400	12	1945040000	1945270000
24	116.84	4.600	12	1945050000	1945280000

The 2-in-1 contact

Every pluggable connector covers two contact points and thus must meet two different requirements: First, the wire termination and second, the connection between plug and pin header. Referring to the 5.0x pitch series, Weidmüller offers different wire connection technologies, but one platform contact for the male / female connection since years. This well-designed hybride platform contact ensures a constant quality on a very high level. Hybride means, that we combine metal material featuring different characteristics by welding, in order to devide the contact system into different function zones: Further to the high electric conductance, the current bar is characterized by its hardness, and the tulip contact by its excellent tension properties. The advantage: each function is supported by the most suitable material to reliably and constantly meet the different electrical and mechanical requirements. To put it in a nutshell: Instead of either ... or, it's even both - perfect for the current, and perfect for the force.



Additional deratings curves

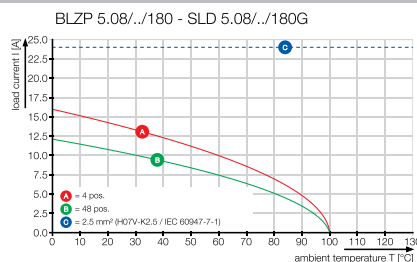
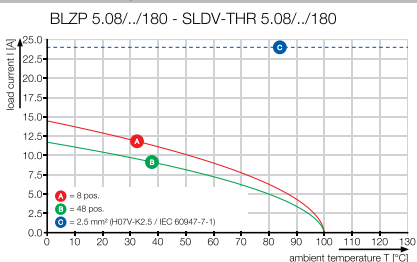

BLZP 5.08/./90

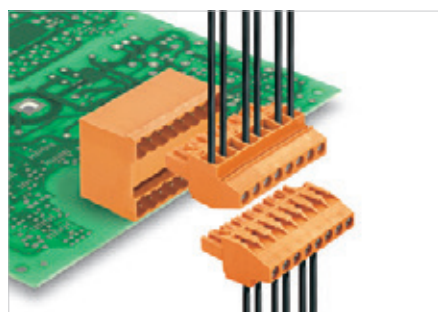

The BLZP is the functional extension of the BLZ series. The „P“ in the part name stands for a plus in security and performance in processing and use.

- WIRE READY – delivered with terminal points already opened
- Power tools can be used with the globally compatible plus/minus screw head
- Folded steel clamping yoke accommodates the connected wire and compensates for temperature fluctuations
- The integrated wire guard prevents dangerous under-insertion of the wire from occurring.
- Lock and release-lever: tool-less locking and gentle releasing of the connector reduces the mechanical stress on the solder joints.

Product data

IEC: 400 V / 15.5 A / 0.2 - 4 mm²
UL: 300 V / 15 A / AWG 30 - 12

For additional articles and information, refer to catalog.weidmuller.com

Note:

- Additional colours on request
- Rated current related to rated cross-section & min. No. of poles.
- Wire end ferrule without plastic collar to DIN 46228/1
- Wire end ferrule with plastic collar to DIN 46228/4
- P on drawing = pitch
- Rated data refer only to the component itself. Clearance and creepage distances to other components are to be designed in accordance with the relevant application standards.

BLZP 5.08/./90



Dimensioned drawing

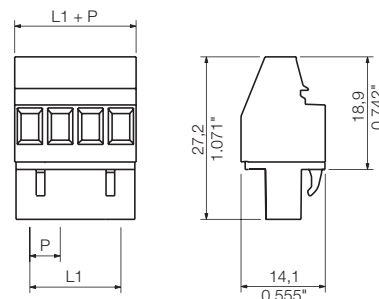

Technical data

In compliance with IEC 60664-1 / IEC 61984			
Clamping range, max.	mm ²	0.13...4	
Solid core H05(07) V-U	mm²	0.2...4	
Stranded H07 V-R			
Flexible H05(07) V-K	mm ²	0.2...4	
Flexible with ferrule	mm ²	0.2...4	
Ferrule with plastic collar	mm ²	0.2...2.5	
Stripping length	mm	7	
Screwdriver blade	mm	0.6 x 3.5, PH 0, PZ 0	
According to norm			
Tightening torque range	Nm	0.4...0.5	
Rated current, max.	A	15.5	12
At ambient temperature		20°C	40°C
For conductor cross-section	mm ²	4	
Overvoltage category		III	III II
Pollution severity		3	2 2
Rated voltage	V	250	320 400
Rated impulse voltage	kV	4	4 4
UL / CUL (Use Group)	B C D		
Rated voltage	V	300	300
Rated current	A	15	10
AWG conductor	AWG	30-12	
CSA (Use Group)	B C D		
Rated voltage	V	300	50 300
Rated current	A	10	10
AWG conductor	AWG	30-12	
General data			
Type of insulation material		PBT	
UL 94 flammability rating		V-0	
Contact base material		Copper alloy	
Material of contact surface		tinned	
Pin dimensions = d	mm		
Solder eyelet Ø = D	mm		
Solder eyelet Ø tolerance	mm		

Accessories

Note: Refer to the Accessories chapter for additional accessories.

Coding		Order No.
	BLZ/SL KO OR	1573010000
	BLZ/SL KO SW	1545710000
Screwdriver		
	SDIS 0.6X3.5X100	9008390000
	SDS 0.6X3.5X100	9008330000
Crosshead screwdriver		
	SDK PH1	9008480000
	SDK PZ1	9008530000

Ordering data

Solder pin length						
Colour	Orange		Black			
Pitch 5.08 mm						
Pol.	L1	(inch)	Qty.	Order No.	Order No.	
2	5.08	0.200	180	1948000000	1948240000	
3	10.16	0.400	120	1948010000	1948250000	
4	15.24	0.600	90	1948020000	1948260000	
5	20.32	0.800	72	1948030000	1948270000	
6	25.40	1.000	60	1948040000	1948280000	
7	30.48	1.200	48	1948050000	1948290000	
8	35.56	1.400	42	1948060000	1948300000	
9	40.64	1.600	36	1948070000	1948310000	
10	45.72	1.800	36	1948080000	1948320000	
11	50.80	2.000	30	1948100000	1948330000	
12	55.88	2.200	30	1948110000	1948340000	
13	60.96	2.400	24	1948120000	1948350000	
14	66.04	2.600	24	1948130000	1948360000	
15	71.12	2.800	24	1948140000	1948370000	
16	76.20	3.000	18	1948150000	1948380000	
17	81.28	3.200	18	1948160000	1948390000	
18	86.36	3.400	18	1948170000	1948400000	
19	91.44	3.600	18	1948180000	1948410000	
20	96.52	3.800	18	1948190000	1948420000	
21	101.60	4.000	12	1948200000	1948430000	
22	106.68	4.200	12	1948210000	1948440000	
23	111.76	4.400	12	1948220000	1948450000	
24	116.84	4.600	12	1948230000	1948460000	

Representative deratings curve

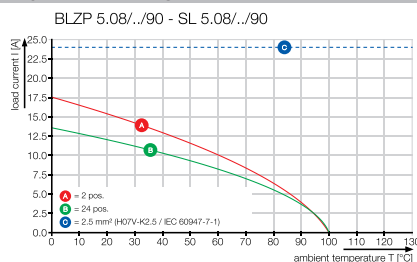

BLZP 5.08/./90F



Dimensioned drawing

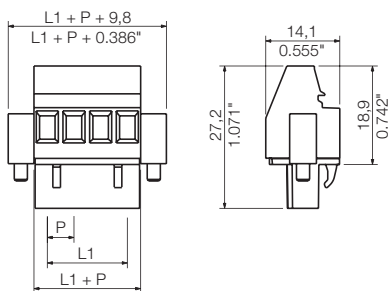

Ordering data

Solder pin length					
Colour	Orange	Black			
Pitch	5.08 mm				
Pol.	L1	(inch)	Qty.	Order No.	Order No.
2	5.08	0.200	90	1949800000	1950040000
3	10.16	0.400	72	1949810000	1950050000
4	15.24	0.600	60	1949820000	1950060000
5	20.32	0.800	48	1949830000	1950070000
6	25.40	1.000	42	1949840000	1950080000
7	30.48	1.200	36	1949850000	1950090000
8	35.56	1.400	36	1949860000	1950100000
9	40.64	1.600	30	1949870000	1950110000
10	45.72	1.800	30	1949880000	1950120000
11	50.80	2.000	24	1949890000	1950130000
12	55.88	2.200	24	1949900000	1950140000
13	60.96	2.400	24	1949910000	1950150000
14	66.04	2.600	18	1949920000	1950160000
15	71.12	2.800	18	1949930000	1950170000
16	76.20	3.000	18	1949940000	1950180000
17	81.28	3.200	18	1949950000	1950190000
18	86.36	3.400	18	1949960000	1950200000
19	91.44	3.600	12	1949970000	1950210000
20	96.52	3.800	12	1949980000	1950220000
21	101.60	4.000	12	1949990000	1950230000
22	106.68	4.200	12	1950010000	1950240000
23	111.76	4.400	12	1950020000	1950250000
24	116.84	4.600	12	1950030000	1950260000

BLZP 5.08/./90LR

with release latch



Dimensioned drawing

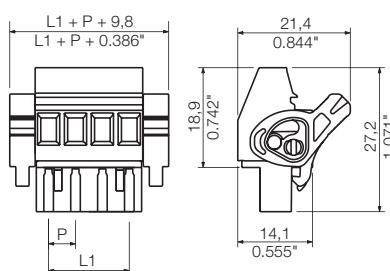

Ordering data

Solder pin length					
Colour	Orange	Black			
Pitch	5.08 mm				
Pol.	L1	(inch)	Qty.	Order No.	Order No.
2	5.08	0.200	90	1087250000	1087020000
3	10.16	0.400	72	1087260000	1087030000
4	15.24	0.600	60	1087270000	1087040000
5	20.32	0.800	48	1087280000	1087050000
6	25.40	1.000	42	1087290000	1087060000
7	30.48	1.200	36	1087300000	1087070000
8	35.56	1.400	36	1087310000	1087080000
9	40.64	1.600	30	1087320000	1087100000
10	45.72	1.800	30	1087330000	1087110000
11	50.80	2.000	24	1087340000	1087120000
12	55.88	2.200	24	1087350000	1087130000
13	60.96	2.400	24	1087360000	1087140000
14	66.04	2.600	18	1087370000	1087150000
15	71.12	2.800	18	1087380000	1087160000
16	76.20	3.000	18	1087390000	1068510000
17	81.28	3.200	18	1087400000	1087170000
18	86.36	3.400	18	1087410000	1087180000
19	91.44	3.600	12	1087420000	1087190000
20	96.52	3.800	12	1087430000	1087200000
21	101.60	4.000	12	1087440000	1087210000
22	106.68	4.200	12	1087450000	1087220000
23	111.76	4.400	12	1087460000	1087230000
24	116.84	4.600	12	1087470000	1087240000

The 2-in-1 contact

Every pluggable connector covers two contact points and thus must meet two different requirements: First, the wire termination and second, the connection between plug and pin header. Referring to the 5.0x pitch series, Weidmüller offers different wire connection technologies, but one platform contact for the male / female connection since years. This well-designed hybride platform contact ensures a constant quality on a very high level. Hybride means, that we combine metal material featuring different characteristics by welding, in order to devide the contact system into different function zones: Further to the high electric conductance, the current bar is characterized by its hardness, and the tulip contact by its excellent tension properties. The advantage: each function is supported by the most suitable material to reliably and constantly meet the different electrical and mechanical requirements. To put it in a nutshell: Instead of either ... or, it's even both - perfect for the current, and perfect for the force.



BLZP 5.08/./270

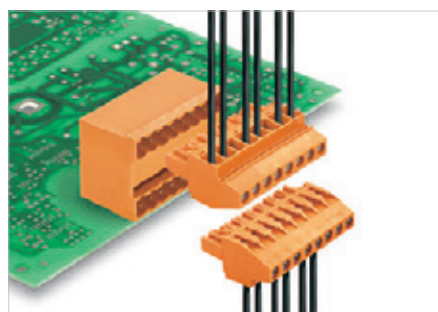

The BLZP is the functional extension of the BLZ series. The „P“ in the part name stands for a plus in security and performance in processing and use.

- WIRE READY - delivered with terminal points already opened
- Power tools can be used with the globally compatible plus/minus screw head
- Folded steel clamping yoke accommodates the connected wire and compensates for temperature fluctuations
- The integrated wire guard prevents dangerous under-insertion of the wire from occurring.
- Lock and release-lever: tool-less locking and gentle releasing of the connector reduces the mechanical stress on the solder joints.

Product data

IEC: 400 V / 15.5 A / 0.2 - 4 mm²
UL: 300 V / 15 A / AWG 30 - 12

For additional articles and information, refer to catalog.weidmueller.com

Note:

- Additional colours on request
- Rated current related to rated cross-section & min. No. of poles.
- Wire end ferrule without plastic collar to DIN 46228/1
- Wire end ferrule with plastic collar to DIN 46228/4
- P on drawing = pitch
- Rated data refer only to the component itself. Clearance and creepage distances to other components are to be designed in accordance with the relevant application standards.

BLZP 5.08/./270



Dimensioned drawing

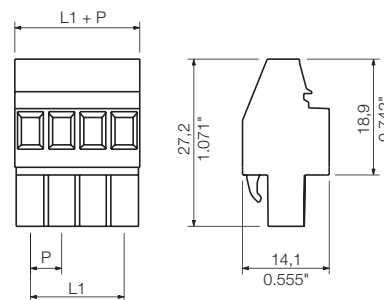

Technical data

In compliance with IEC 60664-1 / IEC 61984			
Clamping range, max.	mm ²	0.13...4	
Solid core H05(07) V-U	mm²	0.2...4	
Stranded H07 V-R			
Flexible H05(07) V-K	mm ²	0.2...4	
Flexible with ferrule	mm ²	0.2...4	
Ferrule with plastic collar	mm ²	0.2...2.5	
Stripping length	mm	7	
Screwdriver blade	mm	0.6 x 3.5, PH 0, PZ 0	
According to norm			
Tightening torque range	Nm	0.4...0.5	
Rated current, max.	A	15.5	12
At ambient temperature		20°C	40°C
For conductor cross-section	mm ²	4	
Overvoltage category		III	III II
Pollution severity		3	2 2
Rated voltage	V	250	320 400
Rated impulse voltage	kV	4	4 4
UL / CUL (Use Group)	B C D	B	C D
Rated voltage	V	300	300
Rated current	A	15	10
AWG conductor	AWG	30-12	
CSA (Use Group)	B C D	B	C D
Rated voltage	V	300	50 300
Rated current	A	10	10
AWG conductor	AWG	30-12	
General data			
Type of insulation material		PBT	
UL 94 flammability rating		V-0	
Contact base material		Copper alloy	
Material of contact surface		tinned	
Pin dimensions = d	mm		
Solder eyelet Ø = D	mm		
Solder eyelet Ø tolerance	mm		

Accessories

Note: Refer to the Accessories chapter for additional accessories.

Coding		Order No.
	BLZ/SL KO OR	1573010000
	BLZ/SL KO SW	1545710000
Screwdriver		
	SDIS 0.6X3.5X100	9008390000
	SDS 0.6X3.5X100	9008330000
Crosshead screwdriver		
	SDK PH1	9008480000
	SDK PZ1	9008530000

Ordering data

Solder pin length					
Colour		Orange	Black		
Pitch 5.08 mm					
Pol.	L1 (inch)	Qty.	Order No.	Order No.	
2	5.08	0.200	180	1948790000	1949020000
3	10.16	0.400	120	1948800000	1949030000
4	15.24	0.600	90	1948810000	1949040000
5	20.32	0.800	72	1948820000	1949050000
6	25.40	1.000	60	1948830000	1949060000
7	30.48	1.200	48	1948840000	1949070000
8	35.56	1.400	42	1948850000	1949080000
9	40.64	1.600	36	1948860000	1949090000
10	45.72	1.800	36	1948870000	1949100000
11	50.80	2.000	30	1948880000	1949110000
12	55.88	2.200	30	1948890000	1949120000
13	60.96	2.400	24	1948900000	1949130000
14	66.04	2.600	24	1948910000	1949140000
15	71.12	2.800	24	1948920000	1949150000
16	76.20	3.000	18	1948930000	1949160000
17	81.28	3.200	18	1948940000	1949170000
18	86.36	3.400	18	1948950000	1949180000
19	91.44	3.600	18	1948960000	1949190000
20	96.52	3.800	18	1948970000	1949200000
21	101.60	4.000	12	1948980000	1949210000
22	106.68	4.200	12	1948990000	1949220000
23	111.76	4.400	12	1949000000	1949230000
24	116.84	4.600	12	1949010000	1949240000

Representative deratings curve

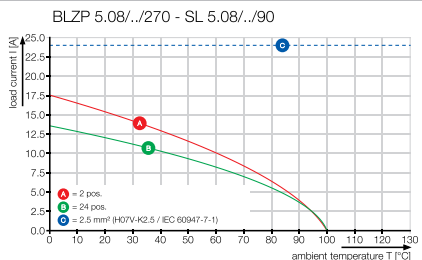

BLZP 5.08/./270F



Dimensioned drawing

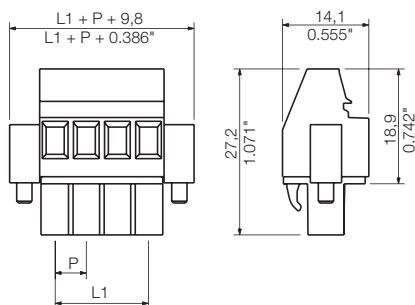

Ordering data

Solder pin length					
Colour		Orange	Black		
Pitch	5.08 mm				
Pol.	L1	(inch)	Qty.	Order No.	Order No.
2	5.08	0.200	90	1950310000	1950550000
3	10.16	0.400	72	1950320000	1950560000
4	15.24	0.600	60	1950330000	1950570000
5	20.32	0.800	48	1950340000	1950580000
6	25.40	1.000	42	1950350000	1950620000
7	30.48	1.200	36	1950360000	1950630000
8	35.56	1.400	36	1950370000	1950640000
9	40.64	1.600	30	1950380000	1950650000
10	45.72	1.800	30	1950390000	1950660000
11	50.80	2.000	24	1950400000	1950670000
12	55.88	2.200	24	1950410000	1950690000
13	60.96	2.400	24	1950420000	1950700000
14	66.04	2.600	18	1950430000	1950710000
15	71.12	2.800	18	1950440000	1950720000
16	76.20	3.000	18	1950450000	1950730000
17	81.28	3.200	18	1950460000	1950740000
18	86.36	3.400	18	1950470000	1950750000
19	91.44	3.600	12	1950480000	1950760000
20	96.52	3.800	12	1950490000	1950770000
21	101.60	4.000	12	1950500000	1950780000
22	106.68	4.200	12	1950510000	1950790000
23	111.76	4.400	12	1950520000	1950800000
24	116.84	4.600	12	1950540000	1950810000

BLZP 5.08/./270LR

with release latch



Dimensioned drawing

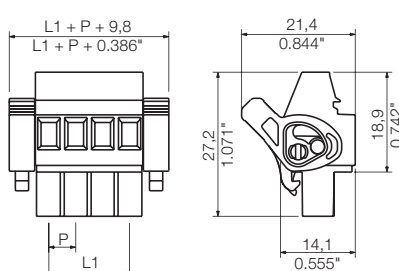

Ordering data

Solder pin length					
Colour		Orange	Black		
Pitch	5.08 mm				
Pol.	L1	(inch)	Qty.	Order No.	Order No.
2	5.08	0.200	90	1947530000	1947760000
3	10.16	0.400	72	1947540000	1947770000
4	15.24	0.600	60	1947550000	1947780000
5	20.32	0.800	48	1947560000	1947790000
6	25.40	1.000	42	1947570000	1947800000
7	30.48	1.200	36	1947580000	1947810000
8	35.56	1.400	36	1947590000	1947820000
9	40.64	1.600	30	1947600000	1947830000
10	45.72	1.800	30	1947610000	1947840000
11	50.80	2.000	24	1947620000	1947850000
12	55.88	2.200	24	1947630000	1947860000
13	60.96	2.400	24	1947640000	1947870000
14	66.04	2.600	18	1947650000	1947880000
15	71.12	2.800	18	1947660000	1947890000
16	76.20	3.000	18	1947670000	1947900000
17	81.28	3.200	18	1947680000	1947910000
18	86.36	3.400	18	1947690000	1947920000
19	91.44	3.600	12	1947700000	1947930000
20	96.52	3.800	12	1947710000	1947940000
21	101.60	4.000	12	1947720000	1947950000
22	106.68	4.200	12	1947730000	1947960000
23	111.76	4.400	12	1947740000	1947970000
24	116.84	4.600	12	1947750000	1947980000

The 2-in-1 contact

Every pluggable connector covers two contact points and thus must meet two different requirements: First, the wire termination and second, the connection between plug and pin header. Referring to the 5.0x pitch series, Weidmüller offers different wire connection technologies, but one platform contact for the male / female connection since years. This well-designed hybride platform contact ensures a constant quality on a very high level. Hybride means, that we combine metal material featuring different characteristics by welding, in order to devide the contact system into different function zones: Further to the high electric conductance, the current bar is characterized by its hardness, and the tulip contact by its excellent tension properties. The advantage: each function is supported by the most suitable material to reliably and constantly meet the different electrical and mechanical requirements. To put it in a nutshell: Instead of either ... or, it 's even both - perfect for the current, and perfect for the force.



BLZP 5.08/./225

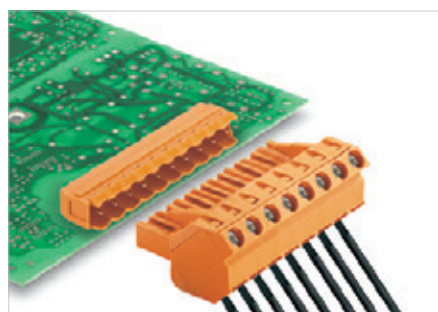

The BLZP is the functional extension of the BLZ series. The „P“ in the part name stands for a plus in security and performance in processing and use.

- WIRE READY – delivered with terminal points already opened
- Power tools can be used with the globally compatible plus/minus screw head
- Folded steel clamping yoke accommodates the connected wire and compensates for temperature fluctuations
- The integrated wire guard prevents dangerous under-insertion of the wire from occurring.
- Lock and release-lever: tool-less locking and gentle releasing of the connector reduces the mechanical stress on the solder joints.

Product data

IEC: 400 V / 17.5 A / 0.2 - 4 mm²
UL: 300 V / 15 A / AWG 30 - 12

For additional articles and information, refer to catalog.weidmueller.com

Note:

- Additional colours on request
- Rated current related to rated cross-section & min. No. of poles.
- Wire end ferrule without plastic collar to DIN 46228/1
- Wire end ferrule with plastic collar to DIN 46228/4
- P on drawing = pitch
- Rated data refer only to the component itself. Clearance and creepage distances to other components are to be designed in accordance with the relevant application standards.

BLZP 5.08/./225



Dimensioned drawing

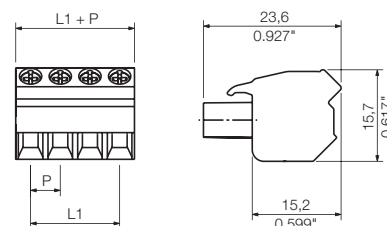

Technical data

In compliance with IEC 60664-1 / IEC 61984			
Clamping range, max.	mm ²	0.13...4	
Solid core H05(07) V-U	mm²	0.2...4	
Stranded H07 V-R			
Flexible H05(07) V-K	mm ²	0.2...4	
Flexible with ferrule	mm ²	0.2...4	
Ferrule with plastic collar	mm ²	0.2...2.5	
Stripping length	mm	7	
Screwdriver blade	mm	0.6 x 3.5, PH 0, PZ 0	
According to norm			
Tightening torque range	Nm	0.4...0.5	
Rated current, max.	A	17.5	14
At ambient temperature		20°C	40°C
For conductor cross-section	mm ²	4	
Overvoltage category		III	III II
Pollution severity		3	2 2
Rated voltage	V	250	320 400
Rated impulse voltage	kV	4	4 4
UL / CUL (Use Group)	B C D		
Rated voltage	V	300	300
Rated current	A	15	10
AWG conductor	AWG	30-12	
CSA (Use Group)	B C D		
Rated voltage	V	300	50 300
Rated current	A	10	10
AWG conductor	AWG	30-12	
General data			
Type of insulation material		PBT	
UL 94 flammability rating		V-0	
Contact base material		Copper alloy	
Material of contact surface		tinned	
Pin dimensions = d	mm		
Solder eyelet Ø = D	mm		
Solder eyelet Ø tolerance	mm		

Accessories

Note: Refer to the Accessories chapter for additional accessories.

Coding		Order No.
	BLZ/SL KO OR	1573010000
	BLZ/SL KO SW	1545710000
Screwdriver		
	SDIS 0.6X3.5X100	9008390000
	SDS 0.6X3.5X100	9008330000
Crosshead screwdriver		
	SDK PH1	9008480000
	SDK PZ1	9008530000

Ordering data

Solder pin length						
Colour	Orange		Black			
Pitch 5.08 mm						
Pol.	L1	(inch)	Qty.	Order No.	Order No.	
2	5.08	0.200	180	1946250000	1946560000	
3	10.16	0.400	120	1946260000	1946570000	
4	15.24	0.600	90	1946270000	1946580000	
5	20.32	0.800	72	1946280000	1946590000	
6	25.40	1.000	60	1946290000	1946600000	
7	30.48	1.200	48	1946300000	1946610000	
8	35.56	1.400	42	1946310000	1946620000	
9	40.64	1.600	36	1946320000	1946630000	
10	45.72	1.800	36	1946330000	1946640000	
11	50.80	2.000	30	1946340000	1946650000	
12	55.88	2.200	30	1946350000	1946660000	
13	60.96	2.400	24	1946360000	1946670000	
14	66.04	2.600	24	1946370000	1946680000	
15	71.12	2.800	24	1946380000	1946690000	
16	76.20	3.000	18	1946390000	1946700000	
17	81.28	3.200	18	1946400000	1946710000	
18	86.36	3.400	18	1946410000	1946720000	
19	91.44	3.600	18	1946420000	1946730000	
20	96.52	3.800	18	1946430000	1946740000	
21	101.60	4.000	12	1946440000	1946750000	
22	106.68	4.200	12	1946450000	1946760000	
23	111.76	4.400	12	1946460000	1946770000	
24	116.84	4.600	12	1946480000	1946780000	

Representative deratings curve

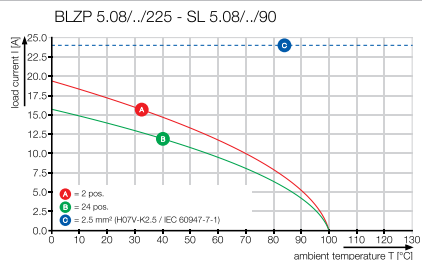

BLZP 5.08/./225B



Dimensioned drawing

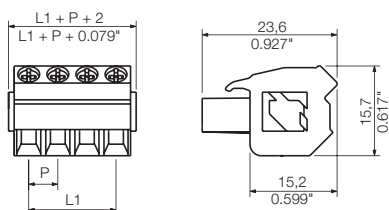

Ordering data

Solder pin length					
Colour		Orange	Black		
Pitch 5.08 mm					
Pol.	L1	(inch)	Qty.	Order No.	Order No.
2	5.08	0.200	150	1945750000	1945980000
3	10.16	0.400	108	1945760000	1945990000
4	15.24	0.600	78	1945770000	1946000000
5	20.32	0.800	66	1945780000	1946010000
6	25.40	1.000	54	1945790000	1946020000
7	30.48	1.200	48	1945800000	1946030000
8	35.56	1.400	42	1945810000	1946040000
9	40.64	1.600	36	1945820000	1946050000
10	45.72	1.800	30	1945830000	1946060000
11	50.80	2.000	30	1945840000	1946070000
12	55.88	2.200	24	1945850000	1946080000
13	60.96	2.400	24	1945860000	1946090000
14	66.04	2.600	24	1945870000	1946100000
15	71.12	2.800	24	1945880000	1946110000
16	76.20	3.000	18	1945890000	1946120000
17	81.28	3.200	18	1945900000	1946130000
18	86.36	3.400	18	1945910000	1946140000
19	91.44	3.600	18	1945920000	1946150000
20	96.52	3.800	18	1945930000	1946160000
21	101.60	4.000	12	1945940000	1946170000
22	106.68	4.200	12	1945950000	1946180000
23	111.76	4.400	12	1945960000	1946190000
24	116.84	4.600	12	1945970000	1946200000

The 2-in-1 contact

Every pluggable connector covers two contact points and thus must meet two different requirements: First, the wire termination and second, the connection between plug and pin header. Referring to the 5.0x pitch series, Weidmüller offers different wire connection technologies, but one platform contact for the male / female connection since years. This well-designed hybride platform contact ensures a constant quality on a very high level. Hybride means, that we combine metal material featuring different characteristics by welding, in order to devide the contact system into different function zones: Further to the high electric conductance, the current bar is characterized by its hardness, and the tulip contact by its excellent tension properties. The advantage: each function is supported by the most suitable material to reliably and constantly meet the different electrical and mechanical requirements. To put it in a nutshell: Instead of either ... or, it 's even both - perfect for the current, and perfect for the force.



BLT 5.08/./180

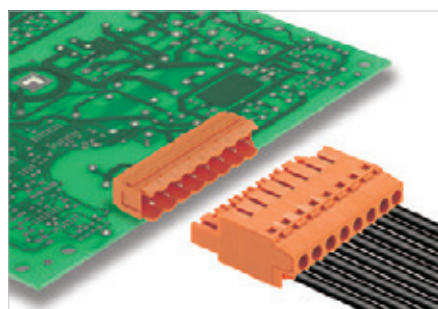

The BLT is currently the most compact TOP connection of its type available in 5.08 mm pitch.

- The BLT's „pull effect“ ensures that the connected wire is pulled in to the clamping point.
- The extra flat shape allows for dense component assembly.
- The specialist for cramped installations
- The screw connect and the cable entry are located on the same side of the connector.
- Lock and release-lever: tool-less locking and gentle releasing of the connector reduces the mechanical stress on the solder joints.

Product data

IEC: 400 V / 17 A / 0.2 - 2.5 mm²
UL: 300 V / 10 A / AWG 26 - 14

For additional articles and information, refer to catalog.weidmueller.com

Note:

- Additional colours on request
- Gold-plated contact surfaces on request
- Rated current related to rated cross-section & min. No. of poles.
- Wire end ferrule without plastic collar to DIN 46228/1
- Wire end ferrule with plastic collar to DIN 46228/4
- Crimp form A for wire end ferrules with PZ 6/5 crimping tool are recommended for the largest cable sizes.
- P on drawing = pitch
- Rated data refer only to the component itself. Clearance and creepage distances to other components are to be designed in accordance with the relevant application standards.

BLT 5.08/./180

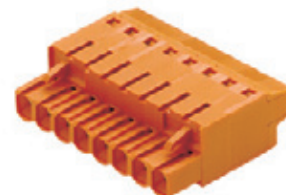

Dimensioned drawing

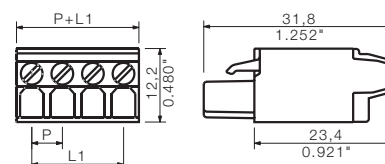

Technical data

In compliance with IEC 60664-1 / IEC 61984		
Clamping range, max.	mm ²	0.13...2.5
Solid core H05(07) V-U	mm²	0.2...2.5
Stranded H07 V-R		
Flexible H05(07) V-K	mm ²	0.2...1.5
Flexible with ferrule	mm ²	0.2...1.5
Ferrule with plastic collar	mm ²	0.2...1.5
Stripping length	mm	13
Screwdriver blade	mm	0.6 x 3.5
According to norm		DIN 5264
Tightening torque range	Nm	0.4...0.5
Rated current, max.	A	17 15
At ambient temperature	20°C	40°C
For conductor cross-section	mm ²	2.5
Overvoltage category		III III II
Pollution severity		3 2 2
Rated voltage	V	250 320 400
Rated impulse voltage	kV	4 4 4
UL / CUL (Use Group)	B C D	D
Rated voltage	V	300 300
Rated current	A	10 10
AWG conductor	AWG	26-14
CSA (Use Group)	B C D	D
Rated voltage	V	300 300
Rated current	A	10 10
AWG conductor	AWG	26-14
General data		
Type of insulation material		PBT
UL 94 flammability rating		V-0
Contact base material		CuSn
Material of contact surface		tinned
Pin dimensions = d	mm	
Solder eyelet Ø = D	mm	
Solder eyelet Ø tolerance	mm	

Accessories

Note: Refer to the Accessories chapter for additional accessories.

Strain relief		Order No.
	BLAT ZE4 OR	1577980000
	BLAT ZE8 OR	1578010000
Coding		
	BLZ/SL KO OR	1573010000
	BLZ/SL KO SW	1545710000
Screwdriver		
	SDIS 0.6X3.5X100	9008390000
	SDS 0.6X3.5X100	9008330000

Ordering data

Solder pin length						
Colour	Orange		Black			
Pitch 5.08 mm						
Pol.	L1	(inch)	Qty.	Order No.	Order No.	
2	5.08	0.200	180	1499560000	1499510000	
3	10.16	0.400	120	1499660000	1499610000	
4	15.24	0.600	90	1499760000	1499710000	
5	20.32	0.800	72	1499860000	1499810000	
6	25.40	1.000	60	1499960000	1499910000	
7	30.48	1.200	48	1500060000	1500010000	
8	35.56	1.400	42	1500160000	1500110000	
9	40.64	1.600	36	1500260000	1500210000	
10	45.72	1.800	36	1500360000	1500310000	
11	50.80	2.000	30	1500460000	1500410000	
12	55.88	2.200	30	1500560000	1500510000	
13	60.96	2.400	24	1500660000	1500610000	
14	66.04	2.600	24	1500760000	1500710000	
15	71.12	2.800	24	1500860000	1500810000	
16	76.20	3.000	18	1500960000	1500910000	
17	81.28	3.200	18	1501060000	1501010000	
18	86.36	3.400	18	1501160000	1501110000	
19	91.44	3.600	18	1501260000	1501210000	
20	96.52	3.800	18	1501360000	1501310000	
21	101.60	4.000	12	1501460000	1501410000	
22	106.68	4.200	12	1501560000	1501510000	
23	111.76	4.400	12	1501660000	1501610000	
24	116.84	4.600	12	1501760000	1501710000	

Representative deratings curve

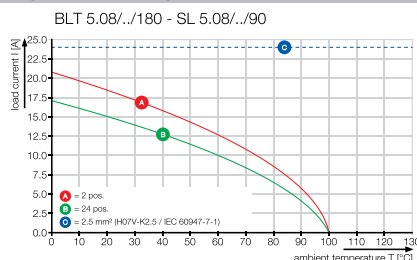

BLT 5.08../180F



Dimensioned drawing

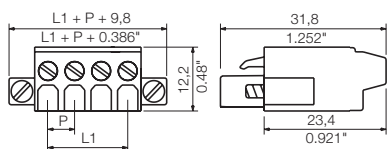

Ordering data

Solder pin length					
Colour	Orange		Black		
Pitch	5.08 mm				
Pol.	L1	(inch)	Qty.	Order No.	Order No.
2	5.08	0.200	90	1843990000	1844220000
3	10.16	0.400	72	1844000000	1844230000
4	15.24	0.600	60	1844010000	1844240000
5	20.32	0.800	48	1844020000	1844250000
6	25.40	1.000	42	1844030000	1844260000
7	30.48	1.200	36	1844040000	1844270000
8	35.56	1.400	36	1844050000	1844280000
9	40.64	1.600	30	1844060000	1844290000
10	45.72	1.800	30	1844070000	1844300000
11	50.80	2.000	24	1844080000	1844310000
12	55.88	2.200	24	1844090000	1844320000
13	60.96	2.400	24	1844100000	1844330000
14	66.04	2.600	18	1844110000	1844340000
15	71.12	2.800	18	1844120000	1844350000
16	76.20	3.000	18	1844130000	1844360000
17	81.28	3.200	18	1844140000	1844370000
18	86.36	3.400	18	1844150000	1844380000
19	91.44	3.600	12	1844160000	1844390000
20	96.52	3.800	12	1844170000	1844400000
21	101.60	4.000	12	1844180000	1844410000
22	106.68	4.200	12	1844190000	1844420000
23	111.76	4.400	12	1844200000	1844430000
24	116.84	4.600	12	1844210000	1844440000

BLT 5.08../180LR

with release bar



Dimensioned drawing

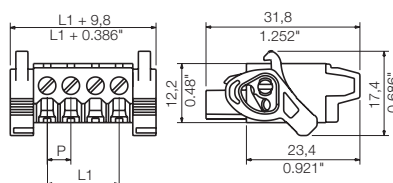

Ordering data

Solder pin length					
Colour	Orange		Black		
Pitch	5.08 mm				
Pol.	L1	(inch)	Qty.	Order No.	Order No.
2	5.08	0.200	90	1890220000	1894130000
3	10.16	0.400	72	1890230000	1894140000
4	15.24	0.600	60	1890240000	1894150000
5	20.32	0.800	48	1890250000	1894160000
6	25.40	1.000	42	1890260000	1894170000
7	30.48	1.200	36	1890270000	1894180000
8	35.56	1.400	36	1890280000	1894190000
9	40.64	1.600	30	1890290000	1894200000
10	45.72	1.800	30	1890300000	1894210000
11	50.80	2.000	24	1890310000	1894220000
12	55.88	2.200	24	1890320000	1894230000
13	60.96	2.400	24	1890330000	1894240000
14	66.04	2.600	18	1890340000	1894250000
15	71.12	2.800	18	1890350000	1894260000
16	76.20	3.000	18	1890360000	1894270000
17	81.28	3.200	18	1890370000	1894280000
18	86.36	3.400	18	1890380000	1894290000
19	91.44	3.600	12	1890390000	1894310000
20	96.52	3.800	12	1890400000	1894330000
21	101.60	4.000	12	1890410000	1894340000
22	106.68	4.200	12	1890420000	1894350000
23	111.76	4.400	12	1890430000	1894360000
24	116.84	4.600	12	1890440000	1894370000

The 2-in-1 contact

Every pluggable connector covers two contact points and thus must meet two different requirements: First, the wire termination and second, the connection between plug and pin header. Referring to the 5.0x pitch series, Weidmüller offers different wire connection technologies, but one platform contact for the male / female connection since years. This well-designed hybride platform contact ensures a constant quality on a very high level. Hybride means, that we combine metal material featuring different characteristics by welding, in order to devide the contact system into different function zones: Further to the high electric conductance, the current bar is characterized by its hardness, and the tulip contact by its excellent tension properties. The advantage: each function is supported by the most suitable material to reliably and constantly meet the different electrical and mechanical requirements. To put it in a nutshell: Instead of either ... or, it 's even both - perfect for the current, and perfect for the force.



BLZ 5.08/./180 QV2

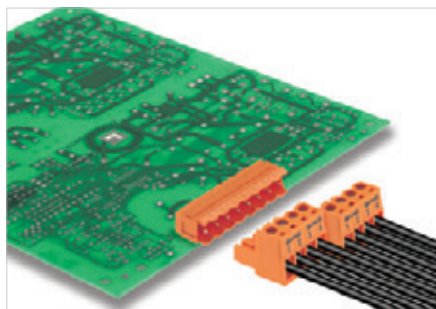

Female plug with clamping-yoke screw connection and internal cross-connections for the 1-2 & 3-4 wire connections; with straight wire outlet.

- Bus signals of up to 32 A can be safely looped through
- This permits an interruption-free decoupling of individual modules from the network.
- Folded steel clamping yoke accommodates the connected wire and compensates for temperature fluctuations
- The cross-connections are clearly marked.

Technical data

In compliance with IEC 60664-1 / IEC 61984		
Clamping range, max.	mm ²	0.13...4
Solid core H05(07) V-U	mm²	0.2...2.5
Stranded H07 V-R		
Flexible H05(07) V-K	mm ²	0.2...4
Flexible with ferrule	mm ²	0.2...2.5
Ferrule with plastic collar	mm ²	0.2...2.5
Stripping length	mm	7
Screwdriver blade	mm	0.6 x 3.5
According to norm		DIN 5264
Tightening torque range	Nm	0.4...0.5
Rated current, max.	A	17.5 15
At ambient temperature	20°C	40°C
For conductor cross-section	mm ²	2.5
Overvoltage category		III III II
Pollution severity		3 2 2
Rated voltage	V	250 320 400
Rated impulse voltage	kV	4 4 4
UL / CUL (Use Group)	B C D	B C D
Rated voltage	V	300 300
Rated current	A	15 10
AWG conductor	AWG	30-12
CSA (Use Group)	B C D	B C D
Rated voltage	V	300 300
Rated current	A	15 10
AWG conductor	AWG	30-12
General data		
Type of insulation material		PBT
UL 94 flammability rating		V-0
Contact base material		Copper alloy
Material of contact surface		tinned
Pin dimensions = d	mm	
Solder eyelet Ø = D	mm	
Solder eyelet Ø tolerance	mm	

Product data

IEC: 400 V / 17.5 A / 0.2 - 2.5 mm²
UL: 300 V / 15 A / AWG 30 - 12

For additional articles and information, refer to catalog.weidmueller.com

Note:

- Additional colours on request
- Gold-plated contact surfaces on request
- Rated current related to rated cross-section & min. No. of poles.
- Wire end ferrule without plastic collar to DIN 46228/1
- Wire end ferrule with plastic collar to DIN 46228/4
- P on drawing = pitch
- Rated data refer only to the component itself. Clearance and creepage distances to other components are to be designed in accordance with the relevant application standards.

BLZ 5.08/./180 QV2

with cross-connection



Dimensioned drawing

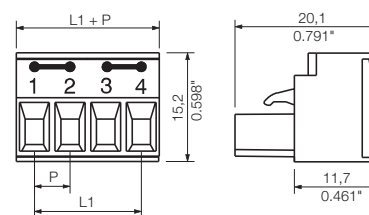

Accessories

Note: Refer to the Accessories chapter for additional accessories.

Strain relief		Order No.
	BLZ 5.08 ZE4 OR	1652110000
	BLZ 5.08 ZE4 SW	1652130000
	BLZ 5.08 ZE8 OR	1652050000
BLZ 5.08 ZE8 SW		1652070000
	Coding	
	BLZ/SL KO OR	1573010000
	BLZ/SL KO SW	1545710000
Screwdriver		
	SDIS 0.6X3.5X100	9008390000
	SDS 0.6X3.5X100	9008330000

Ordering data

Solder pin length						
Colour	Orange		Black			
Pitch	5.08 mm					
Pol.	L1	(inch)	Qty.	Order No.	Order No.	
4	15.24	0.300	100	1839770000	1839780000	

Representative deratings curve

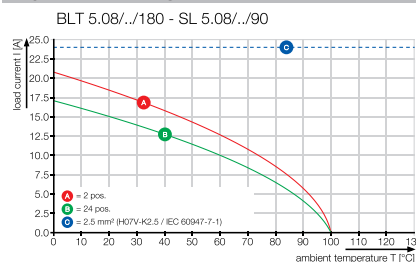

BLZ 5.08/./180F QV2

with cross-connection



Dimensioned drawing

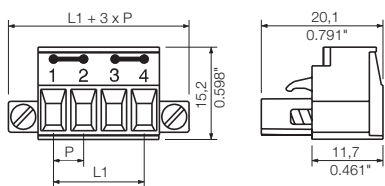

Ordering data

Solder pin length						
Colour		Orange	Black			
Pitch		5.08 mm				
Pol.	L1	(inch)	Qty.	Order No.	Order No.	
4	15.24	0.300	100	1846870000	1844500000	

Examples of applications

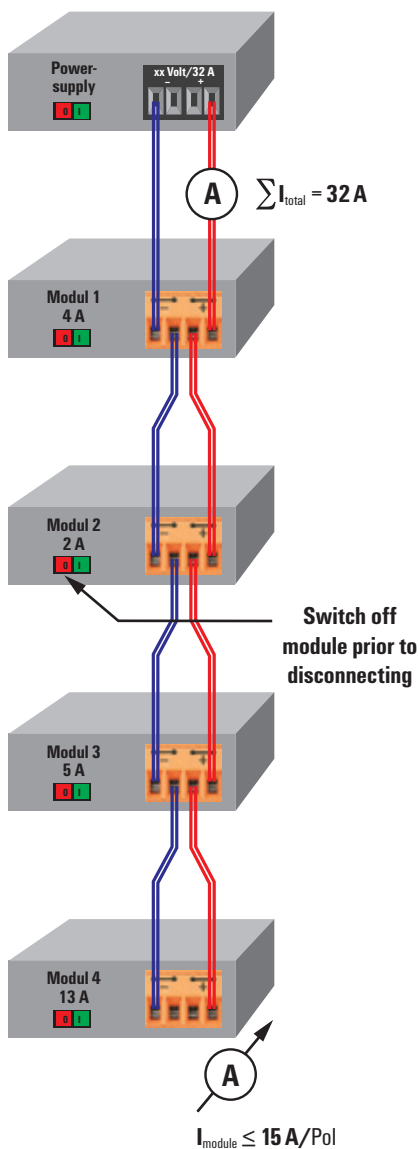

32 A maximum bus current
15 A maximum module current

The 2-in-1 contact

Every pluggable connector covers two contact points and thus must meet two different requirements: First, the wire termination and second, the connection between plug and pin header. Referring to the 5.0x pitch series, Weidmüller offers different wire connection technologies, but one platform contact for the male / female connection since years. This well-designed hybride platform contact ensures a constant quality on a very high level. Hybride means, that we combine metal material featuring different characteristics by welding, in order to divide the contact system into different function zones: Further to the high electric conductance, the current bar is characterized by its hardness, and the tulip contact by its excellent tension properties. The advantage: each function is supported by the most suitable material to reliably and constantly meet the different electrical and mechanical requirements. To put it in a nutshell: Instead of either ... or, it's even both - perfect for the current, and perfect for the force.



BLZ DN 5.08/./180

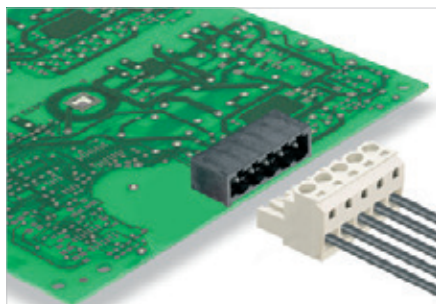

Female plug with clamping-yoke screw connection and straight wire outlet; used as terminating piece in bus applications.

- A manual diagnosis can be carried out using the test point.
- The gold-plated contact system can be plugged in and disconnected up to 1000 times.
- DeviceNet colour markings are clearly visible
- Folded steel clamping yoke accommodates the connected wire and compensates for temperature fluctuations
- Available with screw flange (F).

Technical data

In compliance with IEC 60664-1 / IEC 61984		
Clamping range, max.	mm ²	0.13...3.31
Solid core H05(07) V-U	mm²	0.2...2.5
Stranded H07 V-R		
Flexible H05(07) V-K	mm ²	0.2...2.5
Flexible with ferrule	mm ²	0.2...2.5
Ferrule with plastic collar	mm ²	0.2...2.5
Stripping length	mm	7
Screwdriver blade	mm	0.6 x 3.5
According to norm		DIN 5264
Tightening torque range	Nm	0.4...0.5
Rated current, max.	A	15 12
At ambient temperature	20°C	40°C
For conductor cross-section	mm ²	2.5
Overvoltage category		III III II
Pollution severity		3 2 2
Rated voltage	V	250 320 400
Rated impulse voltage	kV	4 4 4
UL / CUL (Use Group)	B C D	4 4 4
Rated voltage	V	300 300
Rated current	A	15 10
AWG conductor	AWG	22-12
CSA (Use Group)	B C D	4 4 4
Rated voltage	V	300 300
Rated current	A	15 10
AWG conductor	AWG	26-12
General data		
Type of insulation material		PBT
UL 94 flammability rating		V-0
Contact base material		Copper alloy
Material of contact surface		Gold-plated
Pin dimensions = d	mm	
Solder eyelet Ø = D	mm	
Solder eyelet Ø tolerance	mm	

Product data

IEC: 400 V / 15 A / 0.2 - 2.5 mm²
UL: 300 V / 15 A / AWG 22 - 12

For additional articles and information, refer to catalog.weidmuller.com

- Note:**
- Additional colours on request
 - Rated current related to rated cross-section & min. No. of poles.
 - Wire end ferrule without plastic collar to DIN 46228/1
 - Wire end ferrule with plastic collar to DIN 46228/4
 - P on drawing = pitch
 - Rated data refer only to the component itself. Clearance and creepage distances to other components are to be designed in accordance with the relevant application standards.

BLZ DN 5.08/./180 AU

with test point



Dimensioned drawing

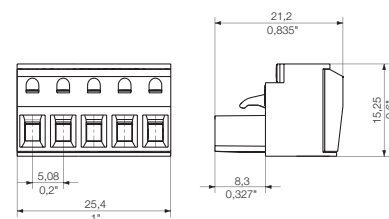

Accessories

Note: Refer to the Accessories chapter for additional accessories.

Strain relief		Order No.
	BLZ 5.08 ZE4 OR	1652110000
	BLZ 5.08 ZE4 SW	1652130000
Coding		
	BLZ/SL KO OR	1573010000
	BLZ/SL KO SW	1545710000
Screwdriver		
	SDIS 0.6X3.5X100	9008390000
	SDS 0.6X3.5X100	9008330000

Ordering data

Solder pin length				
Colour	Pebble grey			
Pitch	5.08 mm			
Pol.	L1	(inch)	Qty.	Order No.
5	20.32	0.800	50	1933560000

Representative deratings curve

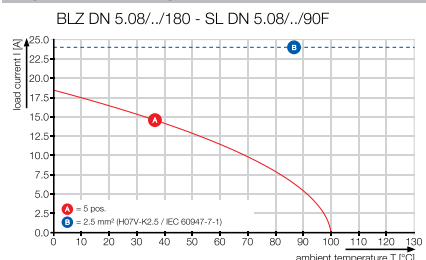

BLZ DN 5.08/./180F AU

with test point and connector guide



Dimensioned drawing

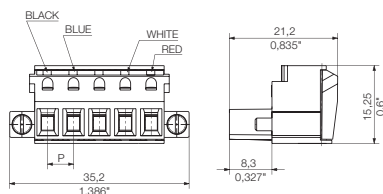

Ordering data

Solder pin length				
Colour		Pebble grey		
Pitch		5.08 mm		
Pol.	L1	(inch)	Qty.	Order No.
5	20.32	0.800	50	1933550000
5	20.32	0.800	50	1933570000

The 2-in-1 contact

Every pluggable connector covers two contact points and thus must meet two different requirements: First, the wire termination and second, the connection between plug and pin header. Referring to the 5.0x pitch series, Weidmüller offers different wire connection technologies, but one platform contact for the male / female connection since years. This well-designed hybride platform contact ensures a constant quality on a very high level. Hybride means, that we combine metal material featuring different characteristics by welding, in order to devide the contact system into different function zones: Further to the high electric conductance, the current bar is characterized by its hardness, and the tulip contact by its excellent tension properties. The advantage: each function is supported by the most suitable material to reliably and constantly meet the different electrical and mechanical requirements. To put it in a nutshell: Instead of either ... or, it 's even both - perfect for the current, and perfect for the force.



BLDZ DN 5.08/./180F

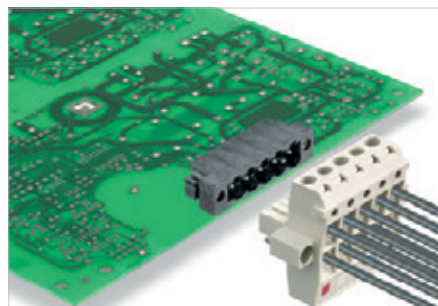

Bus plug with two connections per pole, with clamping-yoke screw connection

- Bus signals can be safely looped through (e.g., DeviceNet)
- This permits an interruption-free decoupling of individual modules from the network.
- A manual diagnosis can be carried out using the test point.
- The gold-plated contact system can be plugged in and disconnected up to 1000 times.
- DeviceNet colour markings are clearly visible
- Folded steel clamping yoke accommodates the connected wire and compensates for temperature fluctuations

Technical data

In compliance with IEC 60664-1 / IEC 61984		
Clamping range, max.	mm ²	0.13...2.5
Solid core H05(07) V-U	mm²	0.2...2.5
Stranded H07 V-R		
Flexible H05(07) V-K	mm ²	0.2...2.5
Flexible with ferrule	mm ²	0.2...2.5
Ferrule with plastic collar	mm ²	0.2...2.5
Stripping length	mm	7
Screwdriver blade	mm	0.6 x 3.5
According to norm		DIN 5264
Tightening torque range	Nm	0.4...0.5
Rated current, max.	A	16 14
At ambient temperature		20°C 40°C
For conductor cross-section	mm ²	2.5
Overvoltage category		III III II
Pollution severity		3 2 2
Rated voltage	V	250 320 400
Rated impulse voltage	kV	4 4 4
UL / CUL (Use Group)	B C D	
Rated voltage	V	300 300
Rated current	A	15 10
AWG conductor	AWG	22-12
CSA (Use Group)	B C D	
Rated voltage	V	300 300
Rated current	A	15 10
AWG conductor	AWG	26-12
General data		
Type of insulation material		PBT
UL 94 flammability rating		V-0
Contact base material		Copper alloy
Material of contact surface		Gold-plated
Pin dimensions = d	mm	
Solder eyelet Ø = D	mm	
Solder eyelet Ø tolerance	mm	

Product data

IEC: 400 V / 16 A / 0.2 - 2.5 mm²
UL: 300 V / 15 A / AWG 22 - 12

For additional articles and information, refer to catalog.weidmueller.com

Note:

- Additional colours on request
- Rated current related to rated cross-section & min. No. of poles.
- Wire end ferrule without plastic collar to DIN 46228/1
- Wire end ferrule with plastic collar to DIN 46228/4
- P on drawing = pitch
- Rated data refer only to the component itself. Clearance and creepage distances to other components are to be designed in accordance with the relevant application standards.

BLDZ DN 5.08/./180F AU

with test point and connector guide



Dimensioned drawing

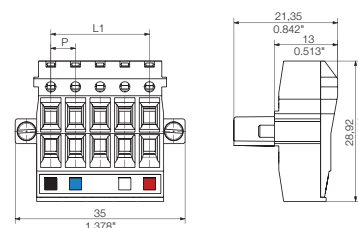

Accessories

Note: Refer to the Accessories chapter for additional accessories.

Coding		Order No.
	BLZ/SL KO OR	1573010000
	BLZ/SL KO SW	1545710000
Screwdriver		
	SDIS 0.6X3.5X100	9008390000
	SDS 0.6X3.5X100	9008330000

Ordering data

Solder pin length				
Colour				Pebble grey
Pitch	5.08 mm			
Pol.	L1	(inch)	Qty.	Order No.
5	20.32	0.800	50	1919990000

Representative deratings curve

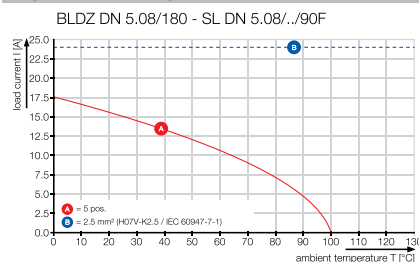

The 2-in-1 contact

Every pluggable connector covers two contact points and thus must meet two different requirements: First, the wire termination and second, the connection between plug and pin header. Referring to the 5.0x pitch series, Weidmüller offers different wire connection technologies, but one platform contact for the male / female connection since years. This well-designed hybride platform contact ensures a constant quality on a very high level.

Hybride means, that we combine metal material featuring different characteristics by welding, in order to devide the contact system into different function zones: Further to the high electric conductance, the current bar is characterized by its hardness, and the tulip contact by its excellent tension properties. The advantage: each function is supported by the most suitable material to reliably and constantly meet the different electrical and mechanical requirements. To put it in a nutshell: Instead of either ... or, it 's even both - perfect for the current, and perfect for the force.



BLDT 5.08/./180

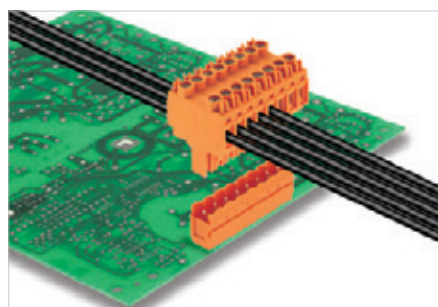

Bus plug with two connections per pole, with clamping-yoke screw connection

- Bus signals can be safely looped through
- This permits an interruption-free decoupling of individual modules from the network.
- Large labelling area on the top side
- Folded steel clamping yoke accommodates the connected wire and compensates for temperature fluctuations

Technical data

In compliance with IEC 60664-1 / IEC 61984		
Clamping range, max.	mm ²	0.13...3.31
Solid core H05(07) V-U	mm ²	0.2...2.5
Stranded H07 V-R		
Flexible H05(07) V-K	mm ²	0.2...2.5
Flexible with ferrule	mm ²	0.2...1.5
Ferrule with plastic collar	mm ²	0.2...1.5
Stripping length	mm	7
Screwdriver blade	mm	0.6 x 3.5
According to norm		DIN 5264
Tightening torque range	Nm	0.4...0.5
Rated current, max.	A	14 12
At ambient temperature	20°C	40°C
For conductor cross-section	mm ²	2.5
Overtoltage category		III III II
Pollution severity		3 2 2
Rated voltage	V	250 320 400
Rated impulse voltage	kV	4 4 4
UL / CUL (Use Group)	B C D	B C D
Rated voltage	V	300 300
Rated current	A	10 10
AWG conductor	AWG	26-12
CSA (Use Group)	B C D	B C D
Rated voltage	V	300 300
Rated current	A	10 10
AWG conductor	AWG	26-12
General data		
Type of insulation material		PBT
UL 94 flammability rating		V-0
Contact base material		Copper alloy
Material of contact surface		tinned
Pin dimensions = d	mm	
Solder eyelet Ø = D	mm	
Solder eyelet Ø tolerance	mm	

Product data

IEC: 400 V / 14 A / 0.2 - 2.5 mm²
UL: 300 V / 10 A / AWG 26 - 12

For additional articles and information, refer to catalog.weidmuller.com

Note:

- Additional colours on request
- Gold-plated contact surfaces on request
- Rated current related to rated cross-section & min. No. of poles.
- Wire end ferrule without plastic collar to DIN 46228/1
- Wire end ferrule with plastic collar to DIN 46228/4
- P on drawing = pitch
- Rated data refer only to the component itself. Clearance and creepage distances to other components are to be designed in accordance with the relevant application standards.

BLDT 5.08/./180



Dimensioned drawing

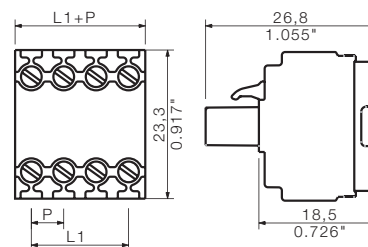

Accessories

Note: Refer to the Accessories chapter for additional accessories.

Coding	Order No.
BLZ/SL KO OR	1573010000
BLZ/SL KO SW	1545710000
Screwdriver	
SDIS 0.6X3.5X100	9008390000
SDS 0.6X3.5X100	9008330000

Ordering data

Solder pin length						
Colour	Orange		Black			
Pitch 5.08 mm						
Pol.	L1	(inch)	Qty.	Order No.	Order No.	
2	5.08	0.200	100	1644730000	1660710000	
3	10.16	0.400	100	1644740000	1660720000	
4	15.24	0.600	50	1644750000	1660730000	
5	20.32	0.800	50	1644760000	1660740000	
6	25.40	1.000	50	1644770000	1660750000	
7	30.48	1.200	50	1644780000	1660760000	
8	35.56	1.400	50	1644790000	1660770000	
9	40.64	1.600	50	1644800000	1660780000	
10	45.72	1.800	50	1644810000	1660790000	
11	50.80	2.000	50	1644820000	1660800000	
12	55.88	2.200	50	1644830000	1660810000	

Representative deratings curve

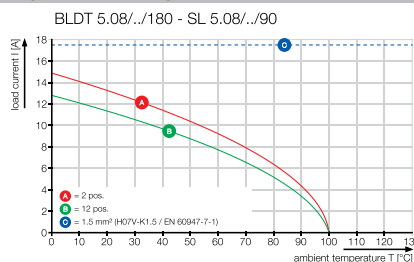

BLDT 5.08/./180B



Dimensioned drawing

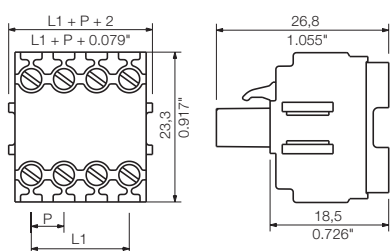

Ordering data

Solder pin length						
Colour		Orange	Black			
Pitch		5.08 mm				
Pol.	L1	(inch)	Qty.	Order No.	Order No.	
2	5.08	0.200	100	1651740000	1673780000	
3	10.16	0.400	100	1651750000	1673790000	
4	15.24	0.600	50	1651760000	1673800000	
5	20.32	0.800	50	1651770000	1673810000	
6	25.40	1.000	50	1651780000	1673820000	
7	30.48	1.200	50	1651790000	1673830000	
8	35.56	1.400	50	1651800000	1673840000	
9	40.64	1.600	50	1651810000	1673850000	
10	45.72	1.800	50	1651820000	1673860000	
11	50.80	2.000	50	1651830000	1673870000	
12	55.88	2.200	50	1651840000	1673880000	

The 2-in-1 contact

Every pluggable connector covers two contact points and thus must meet two different requirements: First, the wire termination and second, the connection between plug and pin header. Referring to the 5.0x pitch series, Weidmüller offers different wire connection technologies, but one platform contact for the male / female connection since years. This well-designed hybride platform contact ensures a constant quality on a very high level. Hybride means, that we combine metal material featuring different characteristics by welding, in order to devide the contact system into different function zones: Further to the high electric conductance, the current bar is characterized by its hardness, and the tulip contact by its excellent tension properties. The advantage: each function is supported by the most suitable material to reliably and constantly meet the different electrical and mechanical requirements. To put it in a nutshell: Instead of either ... or, it 's even both - perfect for the current, and perfect for the force.



BLF 5.08../180

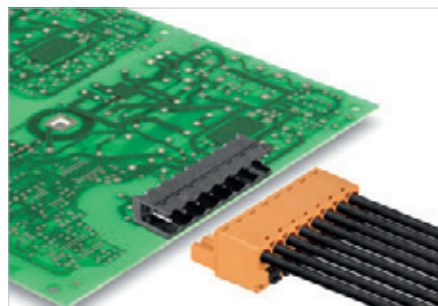

PUSH IN - Weidmüller's innovative connection system simplifies and accelerates the wire connection process.

- Solid wires and stranded wires with ferrules need only to be inserted and they are ready.
- The actuator must be used when connecting stranded wires without ferrules.
- Intuitive handling - since the wire-entry area and handling area are clearly separated.
- User-friendly handling with rounded outer edges and large, no-slip push buttons.
- Lock and release lever: tool-less locking and a gentle releasing of the connector reduces the mechanical stress to the solder joints.

Technical data

In compliance with IEC 60664-1 / IEC 61984			
Clamping range, max.	mm ²	0.13...3.31	
Solid core H05(07) V-U	mm²	0.2...2.5	
Stranded H07 V-R		0..2	
Flexible H05(07) V-K	mm ²	0.2...2.5	
Flexible with ferrule	mm ²	0.2..2.5	
Ferrule with plastic collar	mm ²	0.2..2.5	
Stripping length	mm	10	
Screwdriver blade	mm	0.6 x 3.5	
		According to norm	
Tightening torque range	Nm		
Rated current, max.	A	24	21
At ambient temperature		20°C	40°C
For conductor cross-section	mm ²	2.5	
Overvoltage category		III	III II
Pollution severity		3	2 2
Rated voltage	V	250	320 400
Rated impulse voltage	kV	4	4 4
UL / CUL (Use Group)	B C D	B	C D
Rated voltage	V	300	300
Rated current	A	16	10
AWG conductor	AWG	26-12	
CSA (Use Group)	B C D	B	C D
Rated voltage	V	300	300
Rated current	A	10	10
AWG conductor	AWG	26-12	
General data			
Type of insulation material		PBT	
UL 94 flammability rating		V-0	
Contact base material		CuSn	
Material of contact surface		tinned	
Pin dimensions = d	mm		
Solder eyelet Ø = D	mm		
Solder eyelet Ø tolerance	mm		

Product data

IEC: 400 V / 24 A / 0.2 - 2.5 mm²
UL: 300 V / 16 A / AWG 26 - 12

For additional articles and information, refer to catalog.weidmuller.com

- Note:**
- Additional colours on request
 - Gold-plated contact surfaces on request
 - Rated current related to rated cross-section & min. No. of poles.
 - Wire end ferrule without plastic collar to DIN 46228/1
 - Wire end ferrule with plastic collar to DIN 46228/4
 - P on drawing = pitch

BLF 5.08../180



Dimensioned drawing

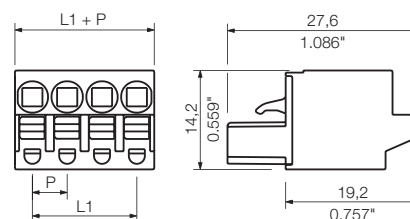

Accessories

Note: Refer to the Accessories chapter for additional accessories.

Coding		Order No.
	BLZ/SL KO OR	1573010000
	BLZ/SL KO SW	1545710000
Screwdriver		
	SDIS 0.6X3.5X100	9008390000
	SDS 0.6X3.5X100	9008330000
Wire-end ferrule		
	H0,5/14S W	9004590000
	H1,0/14S R	9018560000
	H1,5/14S SW	9025240000
	H2,5/14S BL	1333100000

Ordering data

Solder pin length						
Colour	Orange		Black			
Pitch 5.08 mm						
Pol.	L1	(inch)	Qty.	Order No.	Order No.	
2	5.08	0.200	180	1013680000	1013430000	
3	10.16	0.400	120	1013690000	1013440000	
4	15.24	0.600	90	1013710000	1013450000	
5	20.32	0.800	72	1013720000	1013460000	
6	25.40	1.000	60	1013730000	1013470000	
7	30.48	1.200	48	1013740000	1013480000	
8	35.56	1.400	42	1013750000	1013490000	
9	40.64	1.600	36	1013760000	1013510000	
10	45.72	1.800	36	1013770000	1013520000	
11	50.80	2.000	30	1013780000	1013530000	
12	55.88	2.200	30	1013790000	1013540000	
13	60.96	2.400	24	1013810000	1013550000	
14	66.04	2.600	24	1013820000	1013560000	
15	71.12	2.800	24	1013830000	1013570000	
16	76.20	3.000	18	1013840000	1013580000	
17	81.28	3.200	18	1013850000	1013590000	
18	86.36	3.400	18	1013860000	1013610000	
19	91.44	3.600	18	1013870000	1013620000	
20	96.52	3.800	18	1013880000	1013630000	
21	101.60	4.000	12	1013890000	1013640000	
22	106.68	4.200	12	1013910000	1013650000	
23	111.76	4.400	12	1013920000	1013660000	
24	116.84	4.600	12	1013930000	1013670000	

Representative deratings curve

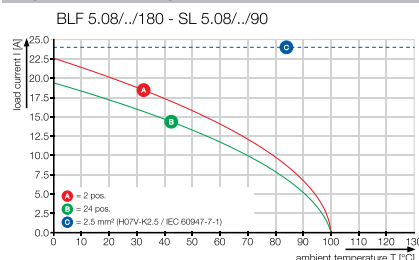

BLF 5.08/./180F



Dimensioned drawing

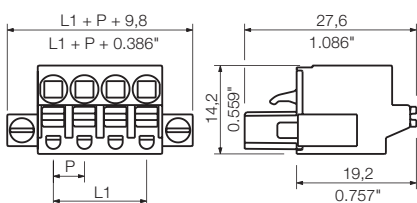

Ordering data

Solder pin length						
Colour		Orange	Black			
Pitch	5.08 mm					
Pol.	L1	(inch)	Qty.	Order No.	Order No.	
2	5.08	0.200	90	1013070000	1012640000	
3	10.16	0.400	72	1013090000	1012650000	
4	15.24	0.600	60	1013110000	1012660000	
5	20.32	0.800	48	1013120000	1012670000	
6	25.40	1.000	42	1013130000	1012680000	
7	30.48	1.200	36	1013140000	1012690000	
8	35.56	1.400	36	1013150000	1012710000	
9	40.64	1.600	30	1013160000	1012720000	
10	45.72	1.800	30	1013170000	1012730000	
11	50.80	2.000	24	1013180000	1012740000	
12	55.88	2.200	24	1013190000	1012750000	
13	60.96	2.400	24	1013210000	1012940000	
14	66.04	2.600	18	1013220000	1012950000	
15	71.12	2.800	18	1013230000	1012960000	
16	76.20	3.000	18	1013240000	1012970000	
17	81.28	3.200	18	1013250000	1012980000	
18	86.36	3.400	18	1013260000	1012990000	
19	91.44	3.600	12	1013270000	1013010000	
20	96.52	3.800	12	1013280000	1013020000	
21	101.60	4.000	12	1013290000	1013030000	
22	106.68	4.200	12	1013310000	1013040000	
23	111.76	4.400	12	1013320000	1013050000	
24	116.84	4.600	12	1013330000	1013060000	

BLF 5.08/./180LR

with release latch



Dimensioned drawing

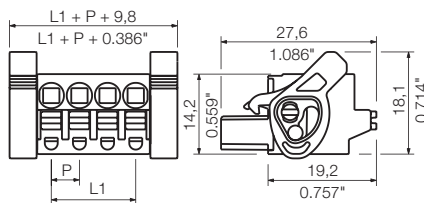

Ordering data

Solder pin length						
Colour		Orange	Black			
Pitch	5.08 mm					
Pol.	L1	(inch)	Qty.	Order No.	Order No.	
2	5.08	0.200	90	1014370000	1014120000	
3	10.16	0.400	72	1014380000	1014130000	
4	15.24	0.600	60	1014390000	1014140000	
5	20.32	0.800	48	1014410000	1014150000	
6	25.40	1.000	42	1014420000	1014160000	
7	30.48	1.200	36	1014430000	1014170000	
8	35.56	1.400	36	1014440000	1014180000	
9	40.64	1.600	30	1014450000	1014190000	
10	45.72	1.800	30	1014460000	1014210000	
11	50.80	2.000	24	1014470000	1014220000	
12	55.88	2.200	24	1014480000	1014230000	
13	60.96	2.400	24	1014490000	1014240000	
14	66.04	2.600	18	1014510000	1014250000	
15	71.12	2.800	18	1014520000	1014260000	
16	76.20	3.000	18	1014530000	1014270000	
17	81.28	3.200	18	1014540000	1014280000	
18	86.36	3.400	18	1014550000	1014290000	
19	91.44	3.600	12	1014560000	1014310000	
20	96.52	3.800	12	1014570000	1014320000	
21	101.60	4.000	12	1014580000	1014330000	
22	106.68	4.200	12	1014590000	1014340000	
23	111.76	4.400	12	1014610000	1014350000	
24	116.84	4.600	12	1014620000	1014360000	

PUSH IN connection technology

PUSH IN connection technology reduces the wiring efforts especially for solid wires and wires with ferrule to a minimum. These connectors are self-explanatory and enable tool-less handling. The contact element made of stainless steel ensures a vibration proof, maintenance free wire termination. The established principle „STEEL FOR THE FORCE, COPPER FOR THE CURRENT“ by Weidmüller offers both, maximum conductor clamping forces, as well as minimum power loss at the same time.



The 2-in-1 contact

Every pluggable connector covers two contact points and thus must meet two different requirements: First, the wire termination and second, the connection between plug and pin header. Referring to the 5.0x pitch series, Weidmüller offers different wire connection technologies, but one platform contact for the male / female connection since years. This well-designed hybride platform contact ensures a constant quality on a very high level. Hybride means, that we combine metal material featuring different characteristics by welding, in order to devide the contact system into different function zones: Further to the high electric conductance, the current bar is characterized by its hardness, and the tulip contact by its excellent tension properties. The advantage: each function is supported by the most suitable material to reliably and constantly meet the different electrical and mechanical requirements. To put it in a nutshell: Instead of either ... or, it's even both - perfect for the current, and perfect for the force.



BLF 5.08/./90

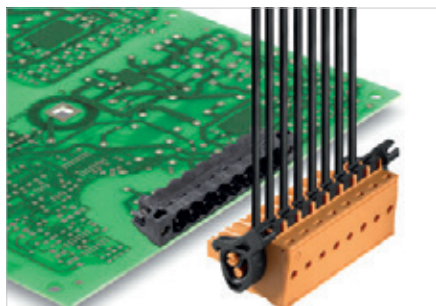

PUSH IN - Weidmüller's innovative connection system simplifies and accelerates the wire connection process.

- Solid wires and stranded wires with ferrules need only to be inserted and they are ready.
- The actuator must be used when connecting stranded wires without ferrules.
- Intuitive handling - since the wire-entry area and handling area are clearly separated.
- User-friendly handling with rounded outer edges and large, no-slip push buttons.
- Lock and release lever: tool-less locking and a gentle releasing of the connector reduces the mechanical stress to the solder joints.

Technical data

In compliance with IEC 60664-1 / IEC 61984		
Clamping range, max.	mm ²	0.13...3.31
Solid core H05(07) V-U	mm ²	0.2...2.5
Stranded H07 V-R		0...2
Flexible H05(07) V-K	mm ²	0.2...2.5
Flexible with ferrule	mm ²	0.2...2.5
Ferrule with plastic collar	mm ²	0.2...2.5
Stripping length	mm	10
Screwdriver blade	mm	0.6 x 3.5
According to norm		DIN 5264
Tightening torque range	Nm	
Rated current, max.	A	24 21
At ambient temperature	20°C	40°C
For conductor cross-section	mm ²	2.5
Overvoltage category		III III II
Pollution severity		3 2 2
Rated voltage	V	250 320 400
Rated impulse voltage	kV	4 4 4
UL / CUL (Use Group)	B C D	D
Rated voltage	V	300 300
Rated current	A	16 10
AWG conductor	AWG	12-26
CSA (Use Group)	B C D	D
Rated voltage	V	300 300
Rated current	A	10 10
AWG conductor	AWG	12-26
General data		
Type of insulation material		PBT
UL 94 flammability rating		V-0
Contact base material		CuSn
Material of contact surface		tinned
Pin dimensions = d	mm	
Solder eyelet Ø = D	mm	
Solder eyelet Ø tolerance	mm	

Product data

IEC: 400 V / 24 A / 0.2 - 2.5 mm²
UL: 300 V / 16 A / AWG 12 - 26

For additional articles and information, refer to catalog.weidmueller.com

- Note:**
- Additional colours on request
 - Gold-plated contact surfaces on request
 - Rated current related to rated cross-section & min. No. of poles.
 - Wire end ferrule without plastic collar to DIN 46228/1
 - Wire end ferrule with plastic collar to DIN 46228/4
 - P on drawing = pitch

BLF 5.08/./90



Dimensioned drawing

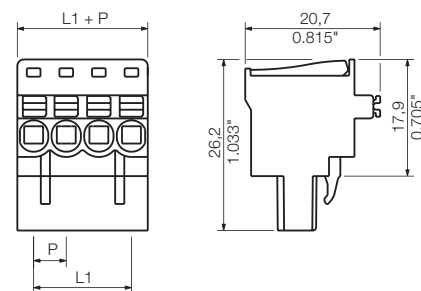

Accessories

Note: Refer to the Accessories chapter for additional accessories.

Coding		Order No.
	BLZ/SL KO OR	1573010000
	BLZ/SL KO SW	1545710000
Screwdriver		
	SDIS 0.6X3.5X100	9008390000
	SDS 0.6X3.5X100	9008330000
Wire-end ferrule		
	H0,5/14S W	9004590000
	H1,0/14S R	9018560000
	H1,5/14S SW	9025240000
	H2,5/14S BL	1333100000

Ordering data

Solder pin length		Orange	Black
Pitch 5.08 mm			
Pol.	L1 (inch)	Qty.	Order No.
2	5.08	0.200	180 1001530000 1000030001
3	10.16	0.400	120 1001540000 1000040001
4	15.24	0.600	90 1001550000 1000050001
5	20.32	0.800	72 1001560000 1000060001
6	25.40	1.000	60 1001570000 1000070001
7	30.48	1.200	48 1001580000 1000080001
8	35.56	1.400	42 1001590000 1000090001
9	40.64	1.600	36 1001600000 1000100001
10	45.72	1.800	36 1001610000 1000110001
11	50.80	2.000	30 1001620000 1000120001
12	55.88	2.200	30 1001630000 1000130001
13	60.96	2.400	24 1001640000 1000140001
14	66.04	2.600	24 1001650000 1000150001
15	71.12	2.800	24 1001660000 1000160001
16	76.20	3.000	18 1001670000 1000170001
17	81.28	3.200	18 1001680000 1000180001
18	86.36	3.400	18 1001690000 1000190001
19	91.44	3.600	18 1001700000 1000200001
20	96.52	3.800	18 1001710000 1000210001

Representative deratings curve

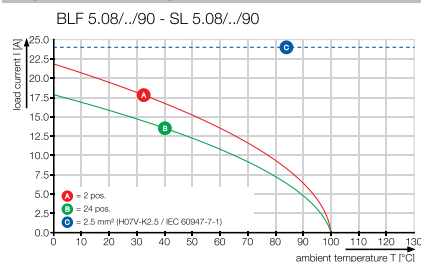

BLF 5.08/./90F



Dimensioned drawing

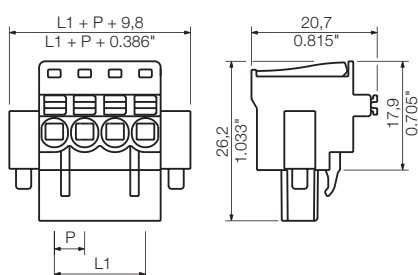

Ordering data

Solder pin length					
Colour	Orange		Black		
Pitch	5.08 mm				
Pol.	L1	(inch)	Qty.	Order No.	Order No.
2	5.08	0.200	90	1002090000	1000220001
3	10.16	0.400	72	1002100000	1000230001
4	15.24	0.600	60	1002110000	1000240001
5	20.32	0.800	48	1002120000	1000250001
6	25.40	1.000	42	1002130000	1000260001
7	30.48	1.200	36	1002140000	1000270001
8	35.56	1.400	36	1002150000	1000280001
9	40.64	1.600	30	1002160000	1000290001
10	45.72	1.800	30	1002170000	1000300001
11	50.80	2.000	24	1002180000	1000310001
12	55.88	2.200	24	1002190000	1000320001
13	60.96	2.400	24	1002200000	1000330001
14	66.04	2.600	18	1002210000	1000340001
15	71.12	2.800	18	1002220000	1000350001
16	76.20	3.000	18	1002230000	1000360001
17	81.28	3.200	18	1002240000	1000370001
18	86.36	3.400	18	1002250000	1000380001
19	91.44	3.600	12	1002260000	1000390001
20	96.52	3.800	12	1002270000	1000400001

BLF 5.08/./90LR

with release latch



Dimensioned drawing

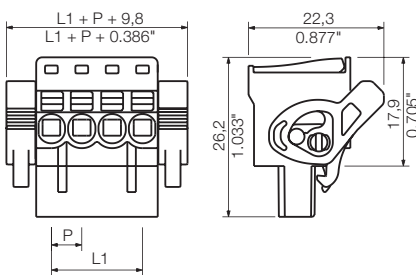

Ordering data

Solder pin length					
Colour	Orange		Black		
Pitch	5.08 mm				
Pol.	L1	(inch)	Qty.	Order No.	Order No.
2	5.08	0.200	90	1002280000	1000410001
3	10.16	0.400	72	1002290000	1000420001
4	15.24	0.600	60	1002300000	1000430001
5	20.32	0.800	48	1002310000	1000440001
6	25.40	1.000	42	1002320000	1000450001
7	30.48	1.200	36	1002330000	1000460001
8	35.56	1.400	36	1002340000	1000470001
9	40.64	1.600	30	1002350000	1000480001
10	45.72	1.800	30	1002360000	1000490001
11	50.80	2.000	24	1002370000	1000500001
12	55.88	2.200	24	1002380000	1000510001
13	60.96	2.400	24	1002390000	1000520001
14	66.04	2.600	18	1002400000	1000530001
15	71.12	2.800	18	1002410000	1000540001
16	76.20	3.000	18	1002420000	1000550001
17	81.28	3.200	18	1002430000	1000560001
18	86.36	3.400	18	1002440000	1000570001
19	91.44	3.600	12	1002450000	1000580001
20	96.52	3.800	12	1002460000	1000590001

PUSH IN connection technology

PUSH IN connection technology reduces the wiring efforts especially for solid wires and wires with ferrule to a minimum. These connectors are self-explanatory and enable tool-less handling. The contact element made of stainless steel ensures a vibration proof, maintenance free wire termination. The established principle „STEEL FOR THE FORCE, COPPER FOR THE CURRENT“ by Weidmüller offers both, maximum conductor clamping forces, as well as minimum power loss at the same time.



The 2-in-1 contact

Every pluggable connector covers two contact points and thus must meet two different requirements: First, the wire termination and second, the connection between plug and pin header. Referring to the 5.0x pitch series, Weidmüller offers different wire connection technologies, but one platform contact for the male / female connection since years. This well-designed hybride platform contact ensures a constant quality on a very high level. Hybride means, that we combine metal material featuring different characteristics by welding, in order to devide the contact system into different function zones: Further to the high electric conductance, the current bar is characterized by its hardness, and the tulip contact by its excellent tension properties. The advantage: each function is supported by the most suitable material to reliably and constantly meet the different electrical and mechanical requirements. To put it in a nutshell: Instead of either ... or, it's even both - perfect for the current, and perfect for the force.



BLF 5.08/./270

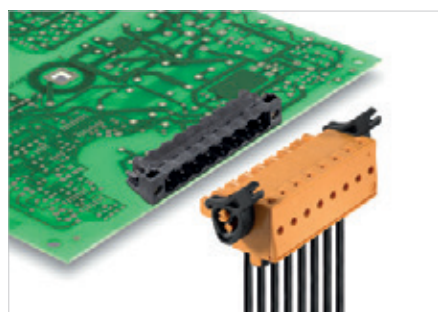

PUSH IN - Weidmüller's innovative connection system simplifies and accelerates the wire connection process.

- Solid wires and stranded wires with ferrules need only to be inserted and they are ready.
- The actuator must be used when connecting stranded wires without ferrules.
- Intuitive handling - since the wire-entry area and handling area are clearly separated.
- User-friendly handling with rounded outer edges and large, no-slip push buttons.
- Lock and release lever: tool-less locking and a gentle releasing of the connector reduces the mechanical stress to the solder joints.

Technical data

In compliance with IEC 60664-1 / IEC 61984			
Clamping range, max.	mm ²	0.13...3.31	
Solid core H05(07) V-U	mm ²	0.2...2.5	
Stranded H07 V-R		0...2	
Flexible H05(07) V-K	mm ²	0.2...2.5	
Flexible with ferrule	mm ²	0.2...2.5	
Ferrule with plastic collar	mm ²	0.2...2.5	
Stripping length	mm	10	
Screwdriver blade	mm	0.6 x 3.5	
According to norm		DIN 5264	
Tightening torque range	Nm		
Rated current, max.	A	24	21
At ambient temperature		20°C	40°C
For conductor cross-section	mm ²	2.5	
Overvoltage category		III	III II
Pollution severity		3	2 2
Rated voltage	V	250	320 400
Rated impulse voltage	kV	4	4 4
UL / CUL (Use Group)	B C D	B C D	B C D
Rated voltage	V	300	300
Rated current	A	16	10
AWG conductor	AWG	12-26	
CSA (Use Group)	B C D	B C D	B C D
Rated voltage	V	300	300
Rated current	A	10	10
AWG conductor	AWG	12-26	
General data			
Type of insulation material		PBT	
UL 94 flammability rating		V-0	
Contact base material		CuSn	
Material of contact surface		tinned	
Pin dimensions = d	mm		
Solder eyelet Ø = D	mm		
Solder eyelet Ø tolerance	mm		

Product data

IEC: 400 V / 24 A / 0.2 - 2.5 mm²
UL: 300 V / 16 A / AWG 12 - 26

For additional articles and information, refer to catalog.weidmueller.com

- Note:**
- Additional colours on request
 - Gold-plated contact surfaces on request
 - Rated current related to rated cross-section & min. No. of poles.
 - Wire end ferrule without plastic collar to DIN 46228/1
 - Wire end ferrule with plastic collar to DIN 46228/4
 - P on drawing = pitch

BLF 5.08/./270



Dimensioned drawing

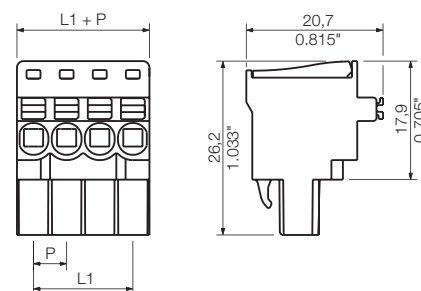

Accessories

Note: Refer to the Accessories chapter for additional accessories.

Coding		Order No.
	BLZ/SL KO OR	1573010000
	BLZ/SL KO SW	1545710000
Screwdriver		
	SDIS 0.6X3.5X100	9008390000
	SDS 0.6X3.5X100	9008330000
Wire-end ferrule		
	H0,5/14S W	9004590000
	H1,0/14S R	9018560000
	H1,5/14S SW	9025240000
	H2,5/14S BL	1333100000

Ordering data

Solder pin length						
Colour	Orange		Black			
Pitch 5.08 mm						
Pol.	L1	(inch)	Qty.	Order No.	Order No.	
2	5.08	0.200	180	1982700000	1981930000	
3	10.16	0.400	120	1982710000	1981940000	
4	15.24	0.600	90	1982720000	1981950000	
5	20.32	0.800	72	1982730000	1981960000	
6	25.40	1.000	60	1982740000	1981970000	
7	30.48	1.200	48	1982750000	1981980000	
8	35.56	1.400	42	1982760000	1981990000	
9	40.64	1.600	36	1982770000	1982000000	
10	45.72	1.800	36	1982780000	1982010000	
11	50.80	2.000	30	1982790000	1982020000	
12	55.88	2.200	30	1982800000	1982030000	
13	60.96	2.400	24	1982810000	1982040000	
14	66.04	2.600	24	1982820000	1982050000	
15	71.12	2.800	24	1982830000	1982060000	
16	76.20	3.000	18	1982840000	1982070000	
17	81.28	3.200	18	1982850000	1982080000	
18	86.36	3.400	18	1982860000	1982090000	
19	91.44	3.600	18	1982870000	1982100000	
20	96.52	3.800	18	1982880000	1982110000	

Representative deratings curve

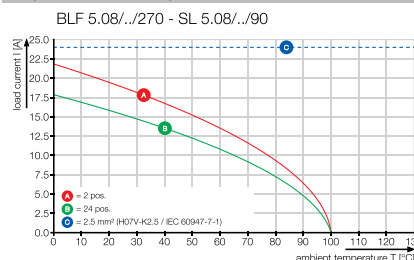

BLF 5.08/././270F



Dimensioned drawing

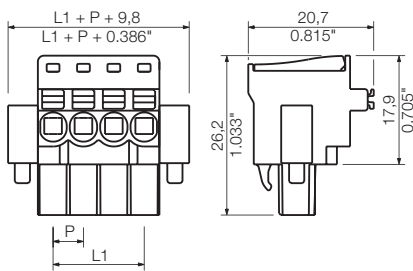

Ordering data

Solder pin length						
Colour		Orange	Black			
Pitch	5.08 mm					
Pol.	L1	(inch)	Qty.	Order No.	Order No.	
2	5.08	0.200	90	1982890000	1982120000	
3	10.16	0.400	72	1982900000	1982130000	
4	15.24	0.600	60	1982910000	1982140000	
5	20.32	0.800	48	1982920000	1982150000	
6	25.40	1.000	42	1982930000	1982160000	
7	30.48	1.200	36	1982940000	1982170000	
8	35.56	1.400	36	1982950000	1982180000	
9	40.64	1.600	30	1982960000	1982190000	
10	45.72	1.800	30	1982970000	1982200000	
11	50.80	2.000	24	1982980000	1982210000	
12	55.88	2.200	24	1982990000	1982220000	
13	60.96	2.400	24	1983000000	1982230000	
14	66.04	2.600	18	1983010000	1982240000	
15	71.12	2.800	18	1983020000	1982250000	
16	76.20	3.000	18	1983030000	1982260000	
17	81.28	3.200	18	1983040000	1982270000	
18	86.36	3.400	18	1983050000	1982280000	
19	91.44	3.600	12	1983060000	1982290000	
20	96.52	3.800	12	1983070000	1982300000	

BLF 5.08/././270LR

with release latch



Dimensioned drawing

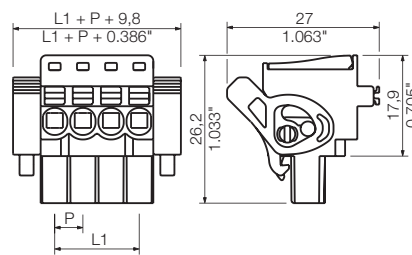

Ordering data

Solder pin length						
Colour		Orange	Black			
Pitch	5.08 mm					
Pol.	L1	(inch)	Qty.	Order No.	Order No.	
2	5.08	0.200	90	1983080000	1982310000	
3	10.16	0.400	72	1983090000	1982320000	
4	15.24	0.600	60	1983100000	1982330000	
5	20.32	0.800	48	1983110000	1982340000	
6	25.40	1.000	42	1983120000	1982350000	
7	30.48	1.200	36	1983130000	1982360000	
8	35.56	1.400	36	1983140000	1982370000	
9	40.64	1.600	30	1983150000	1982380000	
10	45.72	1.800	30	1983160000	1982390000	
11	50.80	2.000	24	1983170000	1982400000	
12	55.88	2.200	24	1983180000	1982410000	
13	60.96	2.400	24	1983190000	1982420000	
14	66.04	2.600	18	1983200000	1982430000	
15	71.12	2.800	18	1983210000	1982440000	
16	76.20	3.000	18	1983220000	1982450000	
17	81.28	3.200	18	1983230000	1982460000	
18	86.36	3.400	18	1983240000	1982470000	
19	91.44	3.600	12	1983250000	1982480000	
20	96.52	3.800	12	1983260000	1982490000	

PUSH IN connection technology

PUSH IN connection technology reduces the wiring efforts especially for solid wires and wires with ferrule to a minimum. These connectors are self-explanatory and enable tool-less handling. The contact element made of stainless steel ensures a vibration proof, maintenance free wire termination. The established principle „STEEL FOR THE FORCE, COPPER FOR THE CURRENT“ by Weidmüller offers both, maximum conductor clamping forces, as well as minimum power loss at the same time.



The 2-in-1 contact

Every pluggable connector covers two contact points and thus must meet two different requirements: First, the wire termination and second, the connection between plug and pin header. Referring to the 5.0x pitch series, Weidmüller offers different wire connection technologies, but one platform contact for the male / female connection since years. This well-designed hybride platform contact ensures a constant quality on a very high level. Hybride means, that we combine metal material featuring different characteristics by welding, in order to devide the contact system into different function zones: Further to the high electric conductance, the current bar is characterized by its hardness, and the tulip contact by its excellent tension properties. The advantage: each function is supported by the most suitable material to reliably and constantly meet the different electrical and mechanical requirements. To put it in a nutshell: Instead of either ... or, it 's even both - perfect for the current, and perfect for the force.



BLDF 5.08/./180

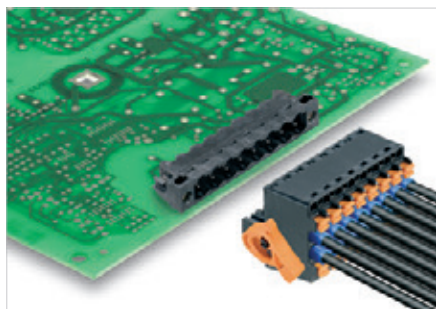

Bus connector with two connections per pole with the time-saving PUSH IN connection system.

- The extremely short cross-connection allows you to safely loop through bus currents of up to 22 A.
- This permits an interruption-free decoupling of individual modules from the network.
- Solid wires and stranded wires with ferrules need only to be inserted and they are ready.
- An actuator must be used when connecting stranded wires with ferrules.
- Lock and release-lever: tool-less locking and gentle releasing of the connector reduces the mechanical stress on the solder joints.

Technical data

In compliance with IEC 60664-1 / IEC 61984			
Clamping range, max.	mm ²	0.13...3.31	
Solid core H05(07) V-U	mm²	0.2...2.5	
Stranded H07 V-R		...2	
Flexible H05(07) V-K	mm ²	0.2...2.5	
Flexible with ferrule	mm ²	0.2...2.5	
Ferrule with plastic collar	mm ²	0.2...2.5	
Stripping length	mm	10	
Screwdriver blade	mm	0.6 x 3.5	
According to norm		DIN 5264	
Tightening torque range	Nm		
Rated current, max.	A	20.8	17.9
At ambient temperature		20°C	40°C
For conductor cross-section	mm ²	2.5	
Overvoltage category		III	III II
Pollution severity		3	2 2
Rated voltage	V	250	320 400
Rated impulse voltage	kV	4	4 4
UL / CUL (Use Group)		B	C D
Rated voltage	V	300	300
Rated current	A	10	10
AWG conductor	AWG	12-26	
CSA (Use Group)		B	C D
Rated voltage	V	300	300
Rated current	A	10	10
AWG conductor	AWG	12-26	
General data			
Type of insulation material		PBT	
UL 94 flammability rating		V-0	
Contact base material		CuSn	
Material of contact surface		tinned	
Pin dimensions = d	mm		
Solder eyelet Ø = D	mm		
Solder eyelet Ø tolerance	mm		
Bus current, max. 20°C		23.3 A	
Bus current, max. 40°C		19.9 A	

Product data

IEC: 400 V / 20.8 A / 0.2 - 2.5 mm²
UL: 300 V / 10 A / AWG 12 - 26

For additional articles and information, refer to catalog.weidmuller.com

Note:

- Additional colours on request
- Gold-plated contact surfaces on request
- Rated current related to rated cross-section & min. No. of poles.
- Wire end ferrule without plastic collar to DIN 46228/1
- Wire end ferrule with plastic collar to DIN 46228/4
- P on drawing = pitch

BLDF 5.08/./180



Dimensioned drawing

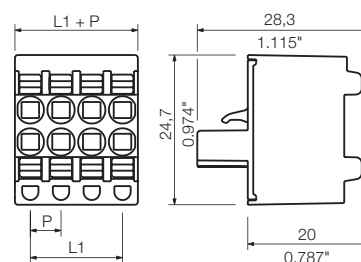

Accessories

Note: Refer to the Accessories chapter for additional accessories.

Coding		Order No.
	BLZ/SL KO OR	1573010000
	BLZ/SL KO SW	1545710000
Screwdriver		
	SDIS 0.6X3.5X100	9008390000
	SDS 0.6X3.5X100	9008330000
Wire-end ferrule		
	H0,5/14S W	9004590000
	H1,0/14S R	9018560000
	H1,5/14S SW	9025240000
	H2,5/14S BL	1333100000

Ordering data

Solder pin length						
Colour	Orange		Black			
Pitch	5.08 mm					
Pol.	L1	(inch)	Qty.	Order No.	Order No.	
2	5.08	0.200	120	1001150000	1000860000	
3	10.16	0.400	80	1001160000	1000870000	
4	15.24	0.600	60	1001170000	1000880000	
5	20.32	0.800	48	1001180000	1000890000	
6	25.40	1.000	40	1001190000	1000900000	
7	30.48	1.200	32	1001200000	1000910000	
8	35.56	1.400	28	1001210000	1000920000	

BLDF 5.08../180F



Dimensioned drawing

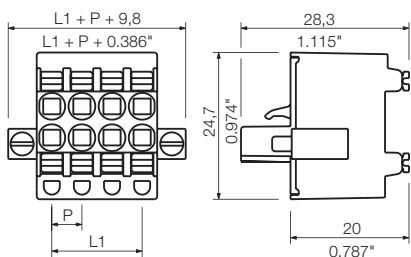

Ordering data

Solder pin length					
Colour		Orange	Black		
Pitch	5.08 mm				
Pol.	L1	(inch)	Qty.	Order No.	Order No.
2	5.08	0.200	60	1001220000	1000930000
3	10.16	0.400	48	1012060000	1000950000
4	15.24	0.600	40	1059420000	1000960000
5	20.32	0.800	32	1065080000	1000970000
6	25.40	1.000	28	1065090000	1000980000
7	30.48	1.200	24	1065110000	1000990000
8	35.56	1.400	24	1065120000	1001000000

BLDF 5.08../180LR

with release latch



Dimensioned drawing

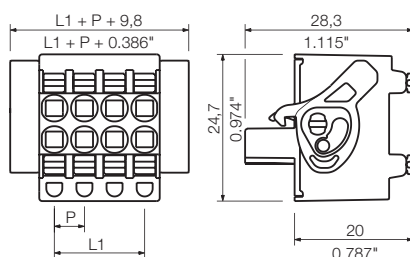

Ordering data

Solder pin length					
Colour		Orange	Black		
Pitch	5.08 mm				
Pol.	L1	(inch)	Qty.	Order No.	Order No.
2	5.08	0.200	60	1065130000	1001010000
3	10.16	0.400	48	1065140000	1001020000
4	15.24	0.600	40	1065150000	1001030000
5	20.32	0.800	32	1065160000	1001040000
6	25.40	1.000	28	1065170000	1001050000
7	30.48	1.200	24	1065180000	1001060000
8	35.56	1.400	24	1065190000	1001070000

PUSH IN connection technology

PUSH IN connection technology reduces the wiring efforts especially for solid wires and wires with ferrule to a minimum. These connectors are self-explanatory and enable tool-less handling. The contact element made of stainless steel ensures a vibration proof, maintenance free wire termination. The established principle „STEEL FOR THE FORCE, COPPER FOR THE CURRENT“ by Weidmüller offers both, maximum conductor clamping forces, as well as minimum power loss at the same time.



The 2-in-1 contact

Every pluggable connector covers two contact points and thus must meet two different requirements: First, the wire termination and second, the connection between plug and pin header. Referring to the 5.0x pitch series, Weidmüller offers different wire connection technologies, but one platform contact for the male / female connection since years. This well-designed hybrite platform contact ensures a constant quality on a very high level. Hybrite means, that we combine metal material featuring different characteristics by welding, in order to divide the contact system into different function zones: Further to the high electric conductance, the current bar is characterized by its hardness, and the tulip contact by its excellent tension properties. The advantage: each function is supported by the most suitable material to reliably and constantly meet the different electrical and mechanical requirements. To put it in a nutshell: Instead of either ... or, it's even both - perfect for the current, and perfect for the force.



BLC 5.08/./180

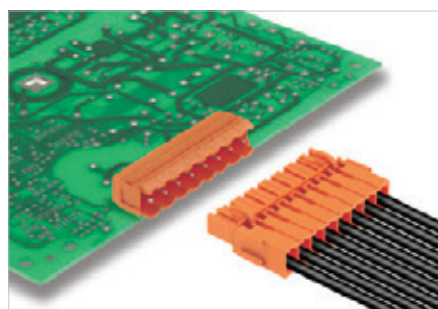

The female plugs with crimp connection can be used for automatically pre-assembled cable harnesses. This results in significant cost savings.

- The contacts are optimised for crimping machines (factory wiring).
- Contacts can also be connected with manual tools (field wiring).
- High component density because of very low height
- Large wire clamping range: 0.22-2.5 mm²
- Contacts can be delivered loose in bulk, or in tape-packaged strips.

Product data

IEC: 400 V / 21 A
UL: 300 V / 10 A / AWG 26 - 14

For additional articles and information, refer to catalog.weidmueller.com

Note:

- Additional colours on request
- Rated current related to rated cross-section & min. No. of poles.
- Rated cross-section depends on crimp contact used.
- P on drawing = pitch
- Rated data refer only to the component itself. Clearance and creepage distances to other components are to be designed in accordance with the relevant application standards.

BLC 5.08/./180R



Dimensioned drawing

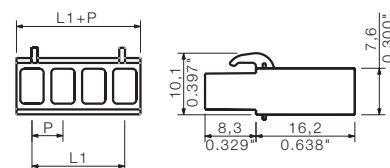

Technical data

In compliance with IEC 60664-1 / IEC 61984		
Clamping range, max.	mm ²	0.22...2.5
Solid core H05(07) V-U	mm²	
Stranded H07 V-R		
Flexible H05(07) V-K	mm ²	0.5...2.5
Flexible with ferrule	mm ²	
Ferrule with plastic collar	mm ²	
Stripping length	mm	5
Screwdriver blade	mm	
According to norm		
Tightening torque range	Nm	
Rated current, max.	A	21 18
At ambient temperature	20°C	40°C
For conductor cross-section	mm ²	2.5
Overvoltage category		III III II
Pollution severity		3 2 2
Rated voltage	V	250 320 400
Rated impulse voltage	kV	4 4 4
UL / CUL (Use Group)		B C D
Rated voltage	V	300 300
Rated current	A	10 10
AWG conductor	AWG	26-14
CSA (Use Group)		B C D
Rated voltage	V	300 300
Rated current	A	10 10
AWG conductor	AWG	26-14
General data		
Type of insulation material		PBT GF
UL 94 flammability rating		V-0
Contact base material		Copper alloy
Material of contact surface		
Pin dimensions = d	mm	
Solder eyelet Ø = D	mm	
Solder eyelet Ø tolerance	mm	

Accessories

Note: Refer to the Accessories chapter for additional accessories.

Coding	Order No.
BLZ/SL KO OR	1573010000
BLZ/SL KO SW	1545710000
DFFC 0.22-0.35 SN 3000	1604230000
DFFC 0.22-0.35 SN E	1604250000
DFFC 0.5-1.0 SN 3000	1480000000
DFFC 0.5-1.0 SN E	1567060000
DFFC 1.5-2.5 SN 2500	1480100000
DFFC 1.5-2.5 SN E	1567070000
Crimping tool	
HTF DFF	9014140000

Ordering data

Solder pin length						
Colour	Orange		Black			
Pitch	5.08 mm					
Pol.	L1	(inch)	Qty.	Order No.	Order No.	
2	5.08	0.200	100	1610490000	1711960000	
3	10.16	0.400	100	1610500000	1711970000	
4	15.24	0.600	100	1610510000	1711980000	
5	20.32	0.800	50	1610520000	1711990000	
6	25.40	1.000	50	1610530000	1712000000	
7	30.48	1.200	50	1610540000	1712010000	
8	35.56	1.400	50	1610550000	1712020000	
9	40.64	1.600	50	1610560000	1712030000	
10	45.72	1.800	50	1610570000	1712040000	
11	50.80	2.000	50	1610580000	1712050000	
12	55.88	2.200	50	1610590000	1712060000	
13	60.96	2.400	50	1610600000	1712070000	
14	66.04	2.600	50	1610610000	1712080000	
15	71.12	2.800	50	1610620000	1712090000	
16	76.20	3.000	50	1610630000	1712100000	

Representative deratings curve

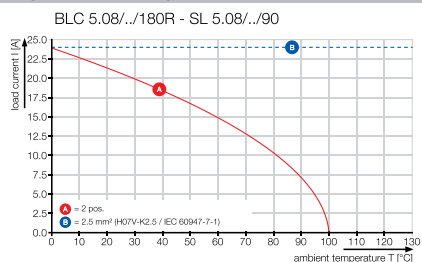

BLC 5.08/./180BR

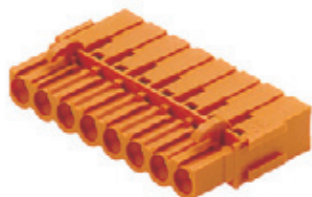

Dimensioned drawing

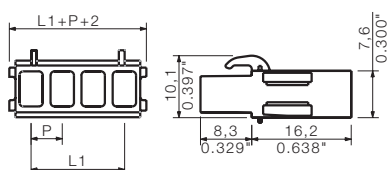

Ordering data

Solder pin length						
Colour		Orange	Black			
Pitch	5.08 mm					
Pol.	L1	(inch)	Qty.	Order No.	Order No.	
2	5.08	0.200	100	1649370000	1712110000	
3	10.16	0.400	100	1649380000	1712120000	
4	15.24	0.600	100	1649390000	1712130000	
5	20.32	0.800	50	1649400000	1712140000	
6	25.40	1.000	50	1649410000	1712150000	
7	30.48	1.200	50	1649420000	1712160000	
8	35.56	1.400	50	1649430000	1712170000	
9	40.64	1.600	50	1649440000	1712180000	
10	45.72	1.800	50	1649450000	1712190000	
11	50.80	2.000	50	1649460000	1712200000	
12	55.88	2.200	50	1649470000	1712210000	
13	60.96	2.400	50	1649480000	1712220000	
14	66.04	2.600	50	1649490000	1712230000	
15	71.12	2.800	50	1649500000	1712240000	
16	76.20	3.000	50	1649510000	1712250000	

BLL 5.08/./90

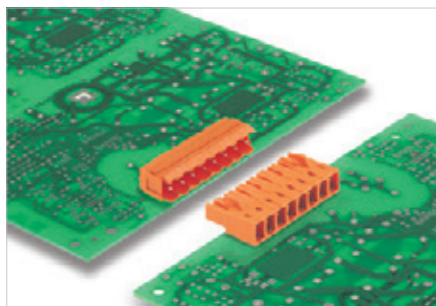

Female headers for mounting on the circuit board; with 90° wire outlet, optimised for the wave soldering process.

- BLL 5.08 & SL 5.08 for board-to-board connections (e.g., backplanes)
- BLL 5.08 & SLS / SLT 5.08 for board-to-wire applications (e.g., power supply for actuators)
- Available with a screw flange (F).

Technical data

In compliance with IEC 60664-1 / IEC 61984			
Clamping range, max.	mm ²		
Solid core H05(07) V-U	mm ²		
Stranded H07 V-R			
Flexible H05(07) V-K	mm ²		
Flexible with ferrule	mm ²		
Ferrule with plastic collar	mm ²		
Stripping length	mm		
Screwdriver blade	mm		
According to norm			
Tightening torque range	Nm		
Rated current, max.	A	23	20
At ambient temperature		20°C	40°C
For conductor cross-section	mm ²		
Overtoltage category		III	III II
Pollution severity		3	2 2
Rated voltage	V	250	320 400
Rated impulse voltage	kV	4	4 4
UL / CUL (Use Group)		B	C D
Rated voltage	V	300	300
Rated current	A	15	10
AWG conductor	AWG		
CSA (Use Group)		B	C D
Rated voltage	V	300	300
Rated current	A	15	10
AWG conductor	AWG		
General data			
Type of insulation material		PBT GF	
UL 94 flammability rating		V-0	
Contact base material		Copper alloy	
Material of contact surface		tinned	
Pin dimensions = d	mm	0.4 x 1.00	
Solder eyelet Ø = D	mm	1.3	
Solder eyelet Ø tolerance	mm	+ 0,1	

Product data

IEC: 400 V / 23 A
UL: 300 V / 15 A

For additional articles and information, refer to catalog.weidmuller.com

- Note:**
- Additional colours on request
 - Gold-plated contact surfaces on request
 - Rated current related to rated cross-section & min. No. of poles.
 - P on drawing = pitch
 - Rated data refer only to the component itself. Clearance and creepage distances to other components are to be designed in accordance with the relevant application standards.

BLL 5.08/./90



Dimensioned drawing

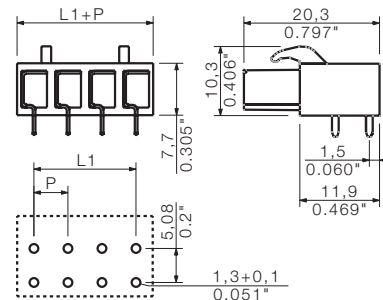

Accessories

Note: Refer to the Accessories chapter for additional accessories.

Coding	Order No.
BLZ/SL KO OR	1573010000
BLZ/SL KO SW	1545710000
Mounting block	
SLA BB11R OR	1604120000
SLA BB11R SW	1692340000

Ordering data

Solder pin length		3.2 mm		
Colour		Orange		
Pitch 5.08 mm				
Pol.	L1	(inch)	Qty.	Order No.
2	5.08	0.200	180	1622940000
3	10.16	0.400	120	1622950000
4	15.24	0.600	90	1622960000
5	20.32	0.800	72	1622970000
6	25.40	1.000	60	1622980000
7	30.48	1.200	48	1622990000
8	35.56	1.400	42	1623000000
9	40.64	1.600	36	1623010000
10	45.72	1.800	36	1623020000
11	50.80	2.000	30	1623030000
12	55.88	2.200	30	1623040000
13	60.96	2.400	24	1648420000
14	66.04	2.600	24	1648430000
15	71.12	2.800	24	1648440000
16	76.20	3.000	18	1648450000
17	81.28	3.200	18	1648460000
18	86.36	3.400	18	1648470000
19	91.44	3.600	18	1648480000
20	96.52	3.800	18	1648490000
21	101.60	4.000	12	1648500000
22	106.68	4.200	12	1648510000
23	111.76	4.400	12	1648520000
24	116.84	4.600	12	1648530000

BLL 5.08/./90FI



Dimensioned drawing

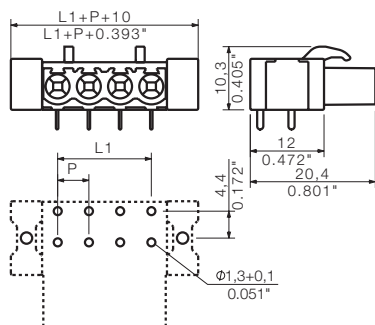

Ordering data

Solder pin length		3.2 mm		
Colour		Orange		
Pitch		5.08 mm		
Pol.	L1	(inch)	Qty.	Order No.
2	5.08	0.200	90	1843750000
3	10.16	0.400	72	1843760000
4	15.24	0.600	60	1843770000
5	20.32	0.800	48	1843780000
6	25.40	1.000	42	1843790000
7	30.48	1.200	36	1843800000
8	35.56	1.400	36	1843810000
9	40.64	1.600	30	1843820000
10	45.72	1.800	30	1843830000
11	50.80	2.000	24	1843840000
12	55.88	2.200	24	1843850000
13	60.96	2.400	24	1843860000
14	66.04	2.600	18	1843870000
15	71.12	2.800	18	1843880000
16	76.20	3.000	18	1843890000
17	81.28	3.200	18	1843900000
18	86.36	3.400	18	1843910000
19	91.44	3.600	12	1843920000
20	96.52	3.800	12	1843930000
21	101.60	4.000	12	1843940000
22	106.68	4.200	12	1843950000
23	111.76	4.400	12	1843960000
24	116.84	4.600	12	1843970000

BLL 5.08/./180

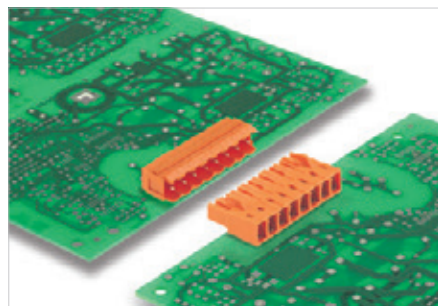

Female headers for mounting on the circuit board; with straight wire outlet, optimised for the wave soldering process.

- BLL 5.08 & SL 5.08 for board-to-board connections (e.g., backplanes)
- BLL 5.08 & SLS / SLT 5.08 for board-to-wire applications (e.g., power supply for actuators)

Technical data

In compliance with IEC 60664-1 / IEC 61984			
Clamping range, max.	mm ²		
Solid core H05(07) V-U	mm ²		
Stranded H07 V-R			
Flexible H05(07) V-K	mm ²		
Flexible with ferrule	mm ²		
Ferrule with plastic collar	mm ²		
Stripping length	mm		
Screwdriver blade	mm		
According to norm			
Tightening torque range	Nm		
Rated current, max.	A	23	20
At ambient temperature		20°C	40°C
For conductor cross-section	mm ²		
Overtolerance category		III	III II
Pollution severity		3	2 2
Rated voltage	V	250	320 400
Rated impulse voltage	kV	4	4 4
UL / CUL (Use Group)		B	C D
Rated voltage	V	300	300
Rated current	A	15	10
AWG conductor	AWG		-
CSA (Use Group)		B	C D
Rated voltage	V	300	300
Rated current	A	15	10
AWG conductor	AWG		-
General data			
Type of insulation material		PBT GF	
UL 94 flammability rating		V-0	
Contact base material		Copper alloy	
Material of contact surface		tinned	
Pin dimensions = d	mm	0.4 x 1.00	
Solder eyelet Ø = D	mm	1.3	
Solder eyelet Ø tolerance	mm	+ 0,1	

Product data

IEC: 400 V / 23 A
UL: 300 V / 15 A

For additional articles and information, refer to catalog.weidmueller.com

- Note:**
- Additional colours on request
 - Gold-plated contact surfaces on request
 - Rated current related to rated cross-section & min. No. of poles.
 - P on drawing = pitch
 - Rated data refer only to the component itself. Clearance and creepage distances to other components are to be designed in accordance with the relevant application standards.

BLL 5.08/./180



Dimensioned drawing

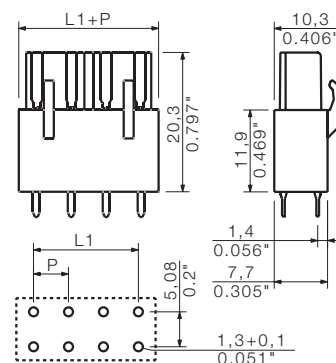

Accessories

Note: Refer to the Accessories chapter for additional accessories.

Coding		Order No.
	BLZ/SL KO OR	1573010000
	BLZ/SL KO SW	1545710000
Mounting block		
	SLA BB11R OR	1604120000
	SLA BB11R SW	1692340000

Ordering data

Solder pin length		3.2 mm		
Colour		Orange		
Pitch		5.08 mm		
Pol.	L1	(inch)	Qty.	Order No.
2	5.08	0.200	180	1630710000
3	10.16	0.400	120	1630720000
4	15.24	0.600	90	1630730000
5	20.32	0.800	72	1630740000
6	25.40	1.000	60	1630750000
7	30.48	1.200	48	1630760000
8	35.56	1.400	42	1630770000
9	40.64	1.600	36	1630780000
10	45.72	1.800	36	1630790000
11	50.80	2.000	30	1630800000
12	55.88	2.200	30	1630810000
13	60.96	2.400	24	1648900000
14	66.04	2.600	24	1648910000
15	71.12	2.800	24	1648920000
16	76.20	3.000	18	1648930000
17	81.28	3.200	18	1648940000
18	86.36	3.400	18	1648950000
19	91.44	3.600	18	1648960000
20	96.52	3.800	18	1648970000
21	101.60	4.000	12	1648980000
22	106.68	4.200	12	1648990000
23	111.76	4.400	12	1649000000
24	116.84	4.600	12	1649010000

BLL 5.08/./180B



Dimensioned drawing

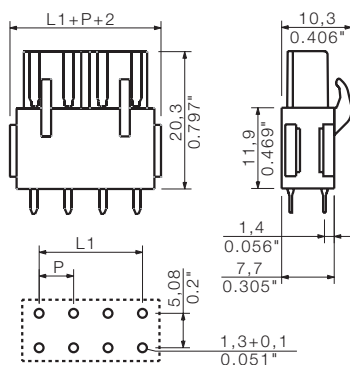

Ordering data

Solder pin length		3.2 mm		
Colour		Orange		
Pitch		5.08 mm		
Pol.	L1	(inch)	Qty.	Order No.
2	5.08	0.200	150	1682730000
3	10.16	0.400	108	1682740000
4	15.24	0.600	78	1682750000
5	20.32	0.800	66	1682760000
6	25.40	1.000	54	1682770000
7	30.48	1.200	48	1682780000
8	35.56	1.400	42	1682790000
9	40.64	1.600	36	1682800000
10	45.72	1.800	30	1682810000
11	50.80	2.000	30	1682820000
12	55.88	2.200	24	1682830000
13	60.96	2.400	24	1682840000
14	66.04	2.600	24	1682850000
15	71.12	2.800	24	1682860000
16	76.20	3.000	18	1682870000
17	81.28	3.200	18	1682880000
18	86.36	3.400	18	1682890000
19	91.44	3.600	18	1682900000
20	96.52	3.800	18	1682910000
21	101.60	4.000	12	1682920000
22	106.68	4.200	12	1682930000
23	111.76	4.400	12	1682940000
24	116.84	4.600	12	1682950000

RSV 1.6 CB / CS

Highest flexibility with the highest density

C A space miracle for the PCB and the field wiring permits up to 36 contacts to be inserted in one operation. The crimp contacts ensure that the contacts can be quickly and flexibly assembled – their plastic cases automatically snap together when joined. This system can be used for many signalling purposes: whether it is soldered on to the circuit board, mounted on the rail using a mounting-rail foot, or built in to the front of the device. This product line also includes versatile coding elements, a choice between tin or gold surfaces, and snap-on plug hoods.

Versatile system-based wiring

Very versatile assembly: different functions can be combined with different wire cross-sections (from 0.14 mm² to 2.5 mm²). Tin-plated or gold-plated contact surfaces can be custom selected from pole to pole based on your application requirements. This delivers clear cost savings. Higher voltages may require larger clearance gaps between the contacts. This problem can be solved without changing to a different type of connector by simply occupying every second pole.

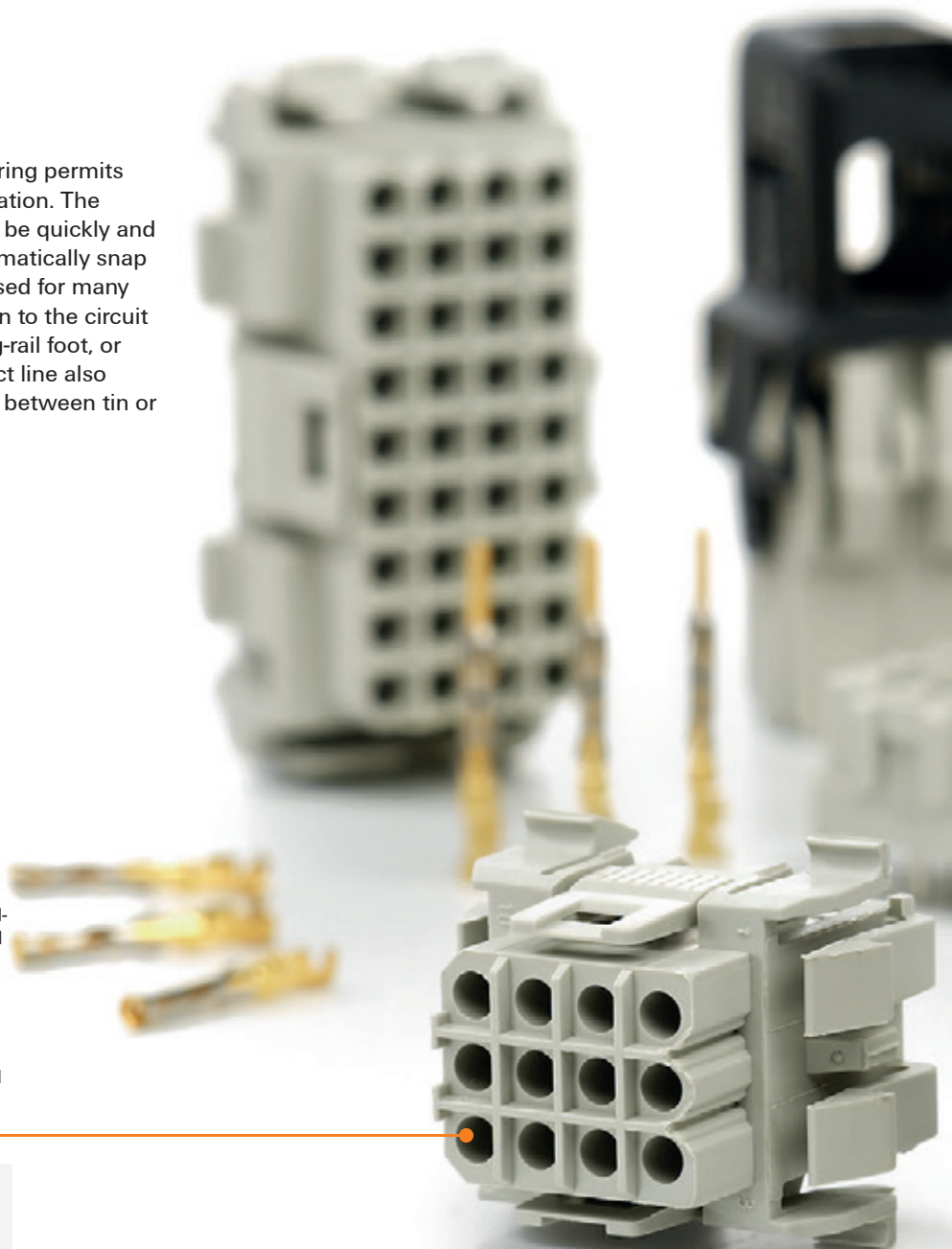

Also with gold contacts to meet application requirements

Gold-plated contacts are the best solution for very low currents or voltages, such as those used with measurements. Gold surfaces are a reliable safeguard against friction corrosion caused by long-term vibrations. Compared to tin contacts which are rated for 100 plugging cycles, gold-plated contacts have an increased rating of 500 plugging cycles.

Highest component assembly density for 5-mm pitch

Every square mm is crucial on the circuit board. The RSV permit 36 poles to fit in a 5-mm pitch on a 40 mm x 29 mm surface.

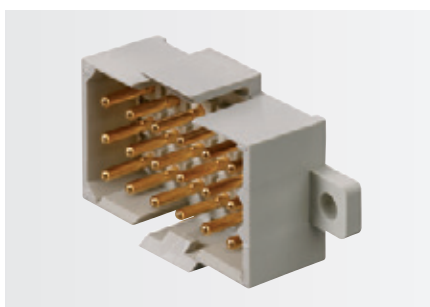

<http://www.OMNIMATE.net>

○	= Wire-to-Board	
●	= Board-to-Board	
●	= Wire-to-Wire	
●	= Board-to-Wire	

C

Series RSV



Type	Contact surface	Flange options	IEC / UL	Levels	Page
------	-----------------	----------------	----------	--------	------

			Type	Contact surface	Flange options	IEC / UL	Levels	Page
Female plug	 Crimp		RSV1.6 CB..	Tin / Gold	(G)	IEC: 630 V/17 A UL: 600 V/10 A/AWG 26 - 12		C.265
		Female header	 Solder connection		RSV1.6 LB.. SN	Tin	(G)/F	IEC: 500 V/14 A UL: 300 V/10 A
	RSV1.6 LB.. AU			Gold	(G)/F	IEC: 500 V/14 A UL: 300 V/10 A	C.262	

(G)* = Closed (without flange)
F = Flange

* = not included in the article description

Male header	Male plug
 Solder connection	 Crimp



1		1
RSV1.6 LS.. SN	RSV1.6 LS.. AU	RSV1.6 CS..
Tin	Gold	Tin / Gold
(G)/F	(G)/F	(G)
IEC: 500 V/14 A UL: 300 V/10 A	IEC: 500 V/14 A UL: 300 V/10 A	IEC: 630 V/17 A UL: 600 V/10 A/AWG 26 - 12
C.256	C.260	C.265
○	○	●
●		●
	●	●

C

Contact system CB 1.6 / CS 1.6

CB 1.6 / CS 1.6

Crimp contacts

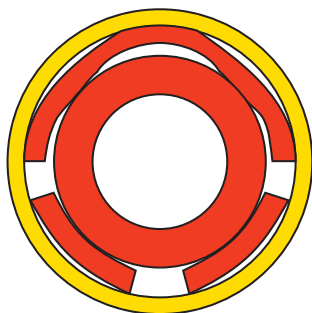
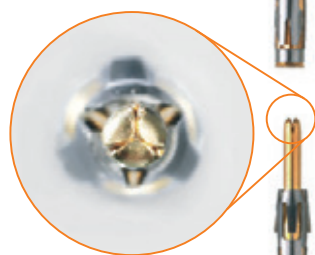
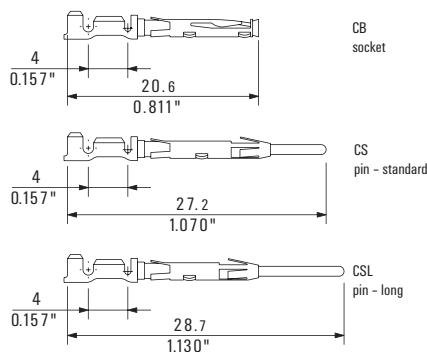

- Safe centring of the contacts using the three-segment pin tips
- 4 defined contact points ensure high contact stability
- Lugs in the enclosing steel spring ensure the contact engages securely in the housing
- Pin contacts with two lengths to implement leading-pin contacts
- Up to 100 plugging cycles (tin version)
- Up to 500 plugging cycles (gold version)

Ordering data

Tinned contacts			
For cable size mm ²	AWG	Insulation diameter mm	
0.14 - 0.25	26 - 24	0.8 - 1.4	pin - standard
			pin - long
			socket
0.34 - 0.5	22 - 20	1.1 - 1.8	pin - standard
			pin - long
			socket
0.34 - 0.5	22 - 20	2.0 - 2.5	pin - standard
			pin - long
			socket
0.75 - 1.5	18 - 16	2.0 - 2.5	pin - standard
			pin - long
			socket
0.75 - 1.5	18 - 16	2.0 - 3.5	pin - standard
			pin - long
			socket
2.5	14 - 12	2.8 - 3.5	pin - standard
			pin - long
			socket
2.5	14 - 12	2.8 - 4.2	pin - standard
			pin - long
			socket

Separate contacts		Cont. on a strip	
Order No.	Qty.	Order No.	Qty.
1421600000	250	1421500000	5000
1421700000	250	1565900000	5000
1421900000	250	1421800000	5000
1423600000	250	1423500000	5000
1423700000	250	1565870000	5000
1423900000	250	1423800000	5000
1425600000	250	1425500000	5000
1425700000	250	1565840000	5000
1425900000	250	1425800000	5000
1427600000	250	1427500000	5000
1427700000	250	1565810000	5000
1427900000	250	1427800000	5000
1582270000	250	1582280000	3000
1582350000	250	1582360000	3000
1582430000	250	1582440000	3000
1429600000	250	1429500000	3000
1429700000	250	1565780000	3000
1429900000	250	1429800000	3000
1582310000	250	1582320000	3000
1582390000	250	1582400000	3000
1582470000	250	1582480000	3000

Ordering data

Tinned contacts			
For cable size mm ²	AWG	Insulation diameter mm	
0.14 - 0.25	26 - 24	0.8 - 1.4	Stift - standard
			pin - long
			socket
0.34 - 0.5	22 - 20	1.1 - 1.8	Stift - standard
			pin - long
			socket
0.34 - 0.5	22 - 20	2.0 - 2.5	Stift - standard
			pin - long
			socket
0.75 - 1.5	18 - 16	2.0 - 2.5	Stift - standard
			pin - long
			socket
0.75 - 1.5	18 - 16	2.0 - 3.5	Stift - standard
			pin - long
			socket
2.5	14 - 12	2.8 - 3.5	Stift - standard
			pin - long
			socket
2.5	14 - 12	2.8 - 4.2	Stift - standard
			pin - long
			socket

Separate contacts		Cont. on a strip	
Order No.	Qty.	Order No.	Qty.
1420600000	250	1420500000	5000
1420700000	250	1565880000	5000
1420900000	250	1420800000	5000
1422600000	250	1422500000	5000
1422700000	250	1565850000	5000
1422900000	250	1422800000	5000
1424600000	250	1424500000	5000
1424700000	250	1565820000	5000
1424900000	250	1424800000	5000
1426600000	250	1426500000	5000
1426700000	250	1565790000	5000
1426900000	250	1426800000	5000
1582250000	250	1582260000	3000
1582330000	250	1582340000	3000
1582410000	250	1582420000	3000
1428600000	250	1428500000	3000
1428700000	250	1565760000	3000
1428900000	250	1428800000	3000
1582290000	250	1582300000	3000
1582370000	250	1582380000	3000
1582450000	250	1582460000	3000

RSV1.6 LS..

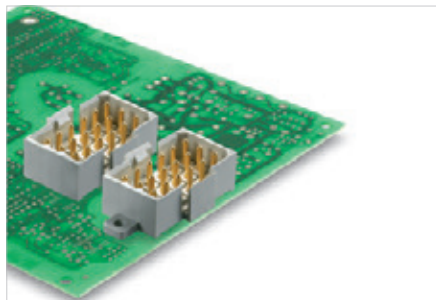

Rectangular plug-in male connector with solder contacts for PCB applications. High connection density achieved by using several rows and crimp contacts in the mating connector. The plug-in connectors can be coded and locked to the mating connector. Supplied in cardboard box.

Technical data

In compliance with IEC 60664-1 / IEC 61984

Clamping range, max.	mm ²		
Solid core H05(07) V-U	mm²		
Stranded H07 V-R			
Flexible H05(07) V-K	mm ²		
Flexible with ferrule	mm ²		
Ferrule with plastic collar	mm ²		
Stripping length	mm		
Screwdriver blade	mm		
According to norm			
Tightening torque range	Nm		
Rated current, max.	A	14	12
At ambient temperature		20°C	40°C
For conductor cross-section	mm ²		
Overtoltage category		III	III II
Pollution severity		3	2 2
Rated voltage	V	250	320 500
Rated impulse voltage	kV	4	2.5 2.5
UL / CUL (Use Group)		B	C D
Rated voltage	V		
Rated current	A		
AWG conductor	AWG		
CSA (Use Group)		B	C D
Rated voltage	V	300	
Rated current	A	13	
AWG conductor	AWG	-	
General data			
Type of insulation material		Wemid (PA)	
UL 94 flammability rating		V-0	
Contact base material		Copper alloy	
Material of contact surface		tinned	
Pin dimensions = d	mm	0.97	
Solder eyelet Ø = D	mm	1.3	
Solder eyelet Ø tolerance	mm	+ 0,1	

Product data

IEC: 500 V / 14 A
UL: 300 V / 10 A

For additional articles and information, refer to catalog.weidmueller.com

Note:

- Additional colours on request
- Rated current related to rated cross-section & min. No. of poles.
- Spacing between rows: see hole layout
- Rated data refer only to the component itself. Clearance and creepage distances to other components are to be designed in accordance with the relevant application standards.

RSV1.6 LS.. SN



Dimensioned drawing

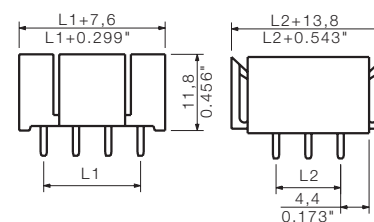

Accessories

Note: Refer to the Accessories chapter for additional accessories.

Coding		Order No.
●	RSV1,6 KO	1567430000

Ordering data

Solder pin length		3.2 mm		
Colour		Pebble grey		
Pitch		5.00 mm		
Pol.	L1	(inch)	Qty.	Order No.
4	5.00	0.197	100	1440500000
6	10.00	0.394	50	1441500000
9	10.00	0.394	50	1442500000
12	15.00	0.591	25	1443500000
18	25.00	0.984	25	1444500000
24	25.00	0.984	20	1445500000
36	40.00	1.575	10	1446500000

Representative deratings curve

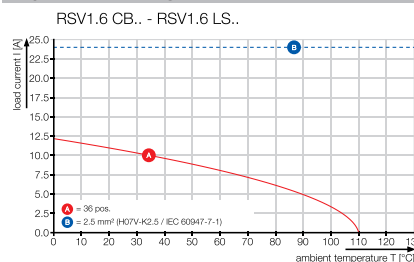

RSV1.6 LSF.. SN

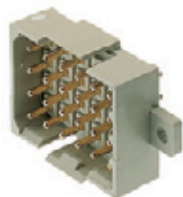

Dimensioned drawing

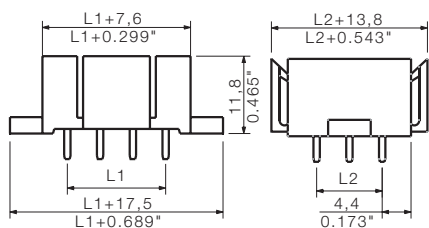

Ordering data

Solder pin length		3.2 mm		
Colour		Pebble grey		
Pitch		5.00 mm		
Pol.	L1	(inch)	Qty.	Order No.
4	5.00	0.197	100	1440900000
6	10.00	0.394	50	1441900000
9	10.00	0.394	50	1442900000
12	15.00	0.591	25	1443900000
18	25.00	0.984	25	1444900000
24	25.00	0.984	20	1445900000
36	40.00	1.575	10	1446900000

Additional deratings curves

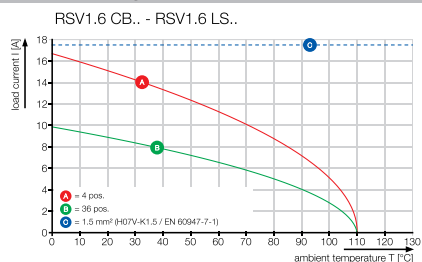

Drilling diagrams

4-pole

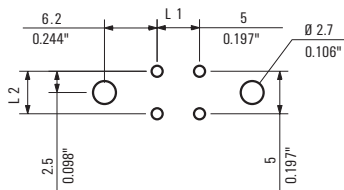

6-pole

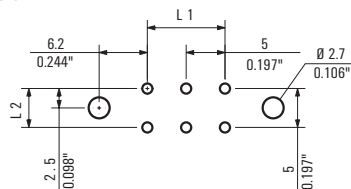

9-pole

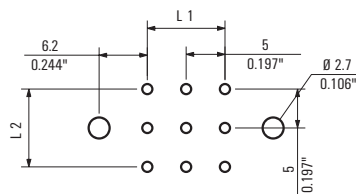

12-pole

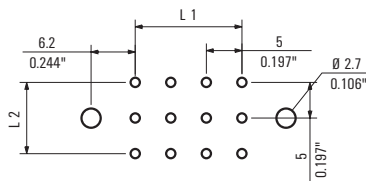

18-pole

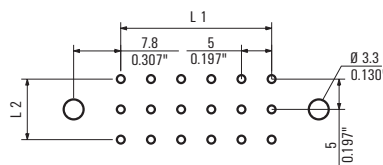

24-pole

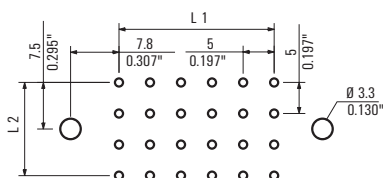

36-pole

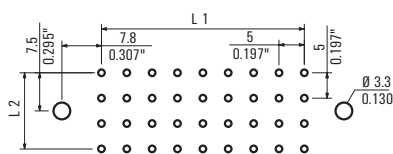

RSV1.6 LB..

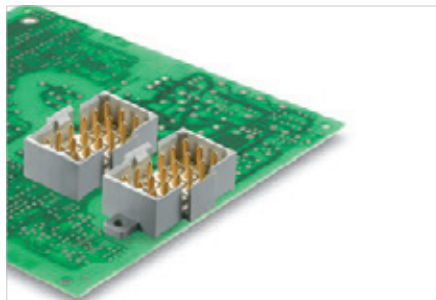

Rectangular plug-in female connector with solder contacts for PCB applications. High connection density achieved by using several rows and crimp contacts in the mating connector. The plug-in connectors can be coded and locked to the mating connector. Supplied in cardboard box.

Technical data

In compliance with IEC 60664-1 / IEC 61984			
Clamping range, max.	mm ²		
Solid core H05(07) V-U	mm²		
Stranded H07 V-R			
Flexible H05(07) V-K	mm ²		
Flexible with ferrule	mm ²		
Ferrule with plastic collar	mm ²		
Stripping length	mm		
Screwdriver blade	mm		
According to norm			
Tightening torque range	Nm		
Rated current, max.	A	14	12
At ambient temperature		20°C	40°C
For conductor cross-section	mm ²		
Overtoltage category		III	III II
Pollution severity		3	2 2
Rated voltage	V	250	320 500
Rated impulse voltage	kV	4	2.5 2.5
UL / CUL (Use Group)		B	C D
Rated voltage	V	300	
Rated current	A	10	
AWG conductor	AWG	-	
CSA (Use Group)		B	C D
Rated voltage	V	300	
Rated current	A	13	
AWG conductor	AWG	-	
General data			
Type of insulation material		Wemid (PA)	
UL 94 flammability rating		V-0	
Contact base material		Copper alloy	
Material of contact surface		tinned	
Pin dimensions = d	mm	0.97	
Solder eyelet Ø = D	mm	1.3	
Solder eyelet Ø tolerance	mm	+ 0,1	

Product data

IEC: 500 V / 14 A
UL: 300 V / 10 A

For additional articles and information, refer to catalog.weidmueller.com

Note:

- Additional colours on request
- Rated current related to rated cross-section & min. No. of poles.
- Spacing between rows: see hole layout
- Rated data refer only to the component itself. Clearance and creepage distances to other components are to be designed in accordance with the relevant application standards.

RSV1.6 LB.. SN



Dimensioned drawing

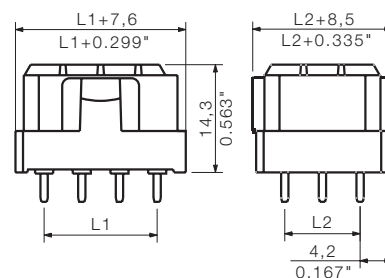

Accessories

Note: Refer to the Accessories chapter for additional accessories.

Coding	Order No.
RSV1,6 KO	1567430000

Ordering data

Solder pin length		3.2 mm		
Colour		Pebble grey		
Pitch	5.00 mm			
Pol.	L1	(inch)	Qty.	Order No.
4	5.00	0.197	100	1440300000
6	10.00	0.394	50	1441300000
9	10.00	0.394	50	1442300000
12	15.00	0.591	25	1443300000
18	25.00	0.984	25	1444300000
24	25.00	0.984	20	1445300000
36	40.00	1.575	10	1446300000

Representative deratings curve

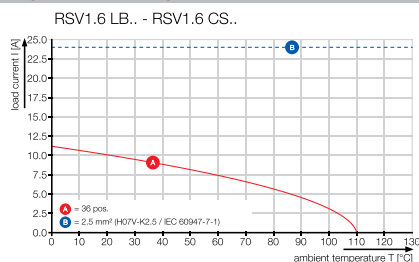

RSV1.6 LB.. SN



Dimensioned drawing

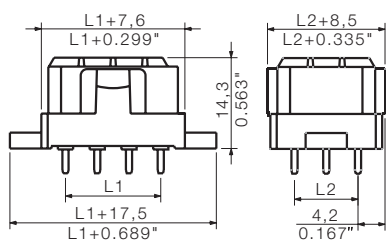

Ordering data

Solder pin length		3.2 mm	
Colour		Pebble grey	
Pitch		5.00 mm	
Pol.	L1	(inch)	Qty. Order No.
4	5.00	0.197	100 1440700000
6	10.00	0.394	50 1441700000
9	10.00	0.394	50 1442700000
12	15.00	0.591	25 1443700000
18	25.00	0.984	25 1444700000
24	25.00	0.984	20 1445700000
36	40.00	1.575	10 1446700000

Additional deratings curves

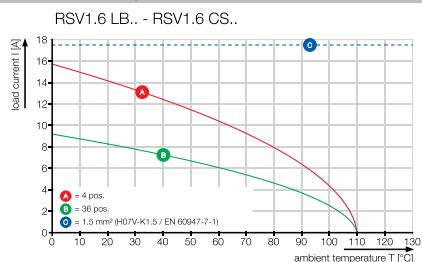

Drilling diagrams

4-pole

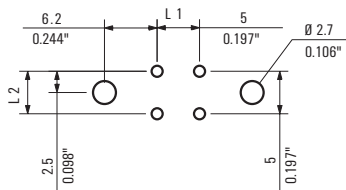

6-pole

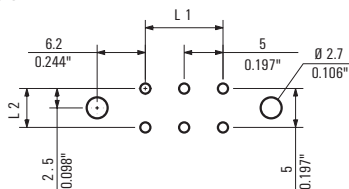

9-pole

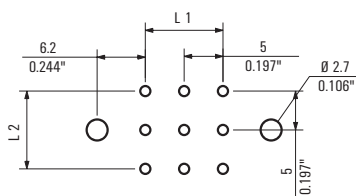

12-pole

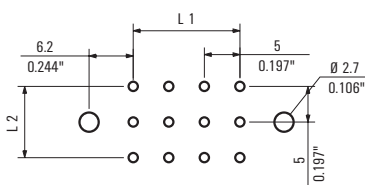

18-pole

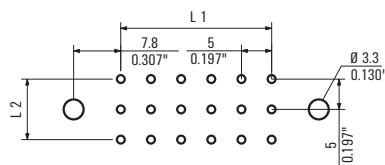

24-pole

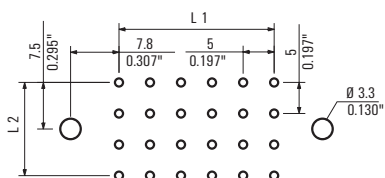

36-pole

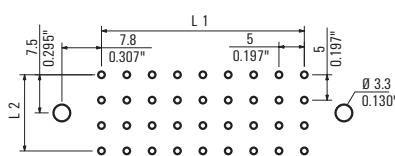

RSV1.6 LS.. AU

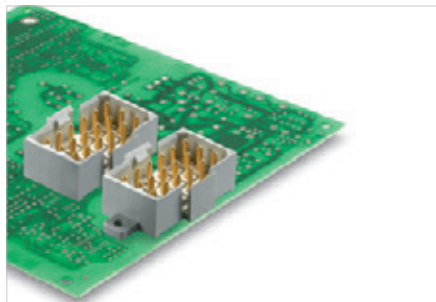

Rectangular plug-in male connector with solder contacts for PCB applications. High connection density achieved by using several rows and crimp contacts in the mating connector. The plug-in connectors can be coded and locked to the mating connector. Supplied in cardboard box.

Technical data

In compliance with IEC 60664-1 / IEC 61984			
Clamping range, max.	mm ²		
Solid core H05(07) V-U	mm²		
Stranded H07 V-R			
Flexible H05(07) V-K	mm ²		
Flexible with ferrule	mm ²		
Ferrule with plastic collar	mm ²		
Stripping length	mm		
Screwdriver blade	mm		
According to norm			
Tightening torque range	Nm		
Rated current, max.	A	14	12
At ambient temperature		20°C	40°C
For conductor cross-section	mm ²		
Overtoltage category		III	III II
Pollution severity		3	2 2
Rated voltage	V	250	320 500
Rated impulse voltage	kV	4	2.5 2.5
UL / CUL (Use Group)		B	C D
Rated voltage	V		
Rated current	A		
AWG conductor	AWG		
CSA (Use Group)		B	C D
Rated voltage	V	300	
Rated current	A	13	
AWG conductor	AWG	-	
General data			
Type of insulation material		Wemid (PA)	
UL 94 flammability rating		V-0	
Contact base material		Copper alloy	
Material of contact surface		Gold-plated	
Pin dimensions = d	mm	0.97	
Solder eyelet Ø = D	mm	1.3	
Solder eyelet Ø tolerance	mm	+ 0,1	

Product data

IEC: 500 V / 14 A
UL: 300 V / 10 A

For additional articles and information, refer to catalog.weidmueller.com

Note:

- Additional colours on request
- Rated current related to rated cross-section & min. No. of poles.
- Spacing between rows: see hole layout
- Rated data refer only to the component itself. Clearance and creepage distances to other components are to be designed in accordance with the relevant application standards.

RSV1.6 LS.. AU

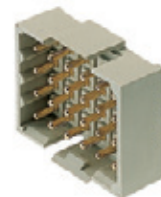

Dimensioned drawing

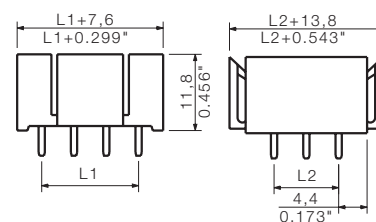

Accessories

Note: Refer to the Accessories chapter for additional accessories.

Coding		Order No.
●	RSV1,6 KO	1567430000

Ordering data

Solder pin length		3.2 mm		
Colour		Pebble grey		
Pitch		5.00 mm		
Pol.	L1	(inch)	Qty.	Order No.
4	5.00	0.197	100	1440400000
6	10.00	0.394	50	1441400000
9	10.00	0.394	50	1442400000
12	15.00	0.591	25	1443400000
18	25.00	0.984	25	1444400000
24	25.00	0.984	20	1445400000
36	40.00	1.575	10	1446400000

Representative deratings curve

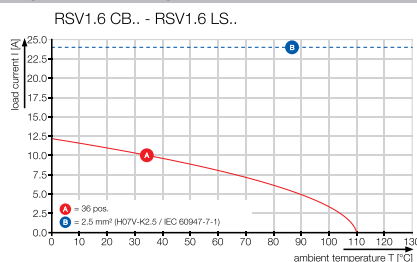

RSV1.6 LSF.. AU

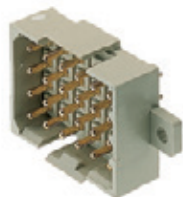

Dimensioned drawing

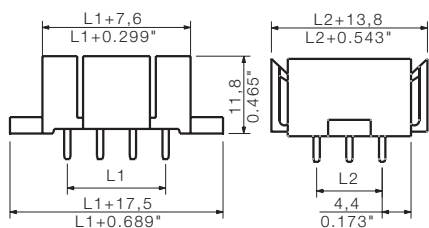

Ordering data

Solder pin length		3.2 mm		
Colour		Pebble grey		
Pitch		5.00 mm		
Pol.	L1	(inch)	Qty.	Order No.
4	5.00	0.197	100	1440800000
6	10.00	0.394	50	1441800000
9	10.00	0.394	50	1442800000
12	15.00	0.591	25	1443800000
18	25.00	0.984	25	1444800000
24	25.00	0.984	20	1445800000
36	40.00	1.575	10	1446800000

Additional deratings curves

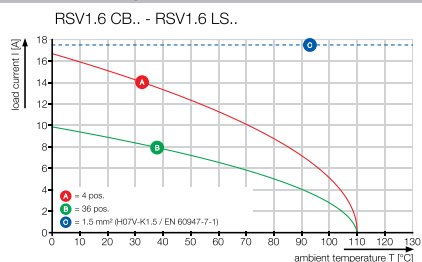

Drilling diagrams

4-pole

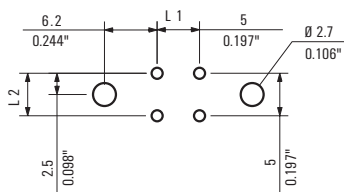

6-pole

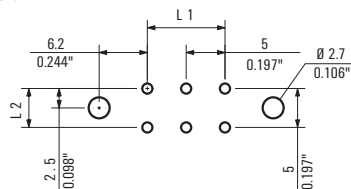

9-pole

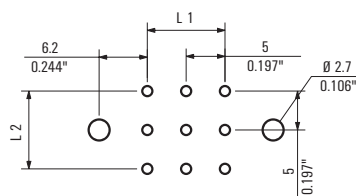

12-pole

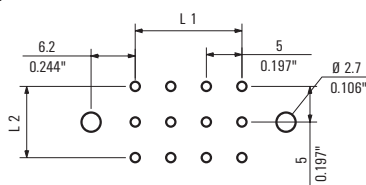

18-pole

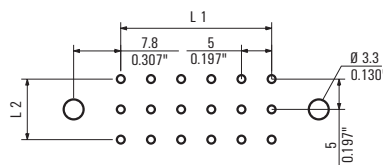

24-pole

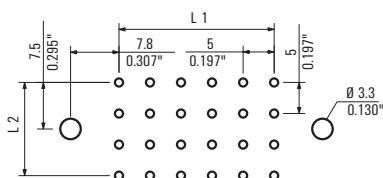

36-pole

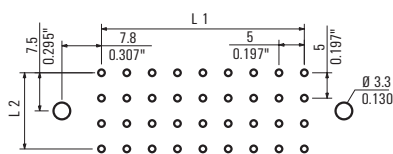

RSV1.6 LB.. AU

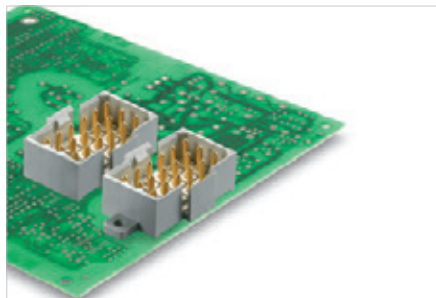

Rectangular plug-in female connector with solder contacts for PCB applications. High connection density achieved by using several rows and crimp contacts in the mating connector. The plug-in connectors can be coded and locked to the mating connector. Supplied in cardboard box.

Technical data

In compliance with IEC 60664-1 / IEC 61984			
Clamping range, max.	mm ²		
Solid core H05(07) V-U	mm²		
Stranded H07 V-R			
Flexible H05(07) V-K	mm ²		
Flexible with ferrule	mm ²		
Ferrule with plastic collar	mm ²		
Stripping length	mm		
Screwdriver blade	mm		
According to norm			
Tightening torque range	Nm		
Rated current, max.	A	14	12
At ambient temperature		20°C	40°C
For conductor cross-section	mm ²		
Overtoltage category		III	III II
Pollution severity		3	2 2
Rated voltage	V	250	320 500
Rated impulse voltage	kV	4	2.5 2.5
UL / CUL (Use Group)		B	C D
Rated voltage	V	300	
Rated current	A	10	
AWG conductor	AWG	-	
CSA (Use Group)		B	C D
Rated voltage	V	300	
Rated current	A	13	
AWG conductor	AWG	-	
General data			
Type of insulation material		Wemid (PA)	
UL 94 flammability rating		V-0	
Contact base material		Copper alloy	
Material of contact surface		Gold-plated	
Pin dimensions = d	mm	0.97	
Solder eyelet Ø = D	mm	1.3	
Solder eyelet Ø tolerance	mm	+ 0,1	

Product data

IEC: 500 V / 14 A
UL: 300 V / 10 A

For additional articles and information, refer to catalog.weidmueller.com

Note:

- Additional colours on request
- Rated current related to rated cross-section & min. No. of poles.
- Spacing between rows: see hole layout
- Rated data refer only to the component itself. Clearance and creepage distances to other components are to be designed in accordance with the relevant application standards.

RSV1.6 LB.. AU



Dimensioned drawing

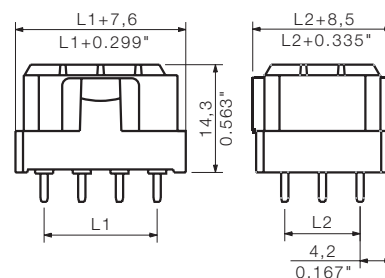

Accessories

Note: Refer to the Accessories chapter for additional accessories.

Coding		Order No.
●	RSV1,6 KO	1567430000

Ordering data

Solder pin length		3.2 mm		
Colour		Pebble grey		
Pitch	5.00 mm			
Pol.	L1	(inch)	Qty.	Order No.
4	5.00	0.197	100	1440200000
6	10.00	0.394	50	1441200000
9	10.00	0.394	50	1442200000
12	15.00	0.591	25	1443200000
18	25.00	0.984	25	1444200000
24	25.00	0.984	20	1445200000
36	40.00	1.575	10	1446200000

Representative deratings curve

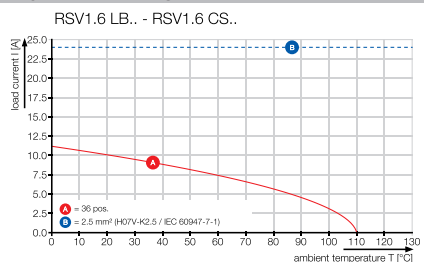

RSV1.6 LBF.. AU



Dimensioned drawing

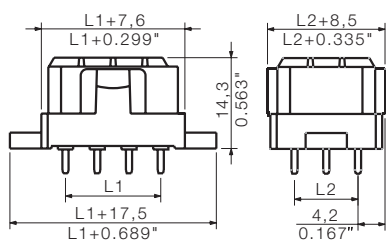

Ordering data

Solder pin length		3.2 mm		
Colour		Pebble grey		
Pitch		5.00 mm		
Pol.	L1	(inch)	Qty.	Order No.
4	5.00	0.197	100	1440600000
6	10.00	0.394	50	1441600000
9	10.00	0.394	50	1442600000
12	15.00	0.591	25	1443600000
18	25.00	0.984	25	1444600000
24	25.00	0.984	20	1445600000
36	40.00	1.575	10	1446600000

Drilling diagrams

4-pole

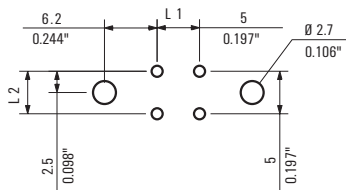

6-pole

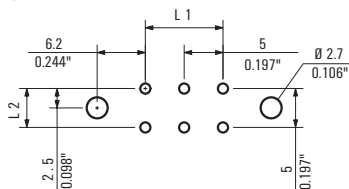

9-pole

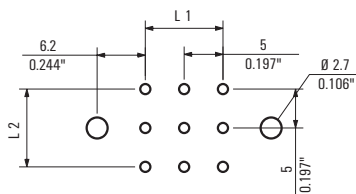

12-pole

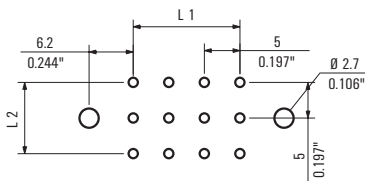

18-pole

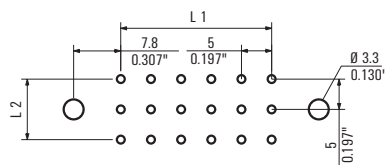

24-pole

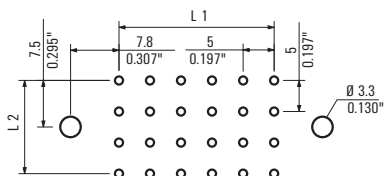

36-pole

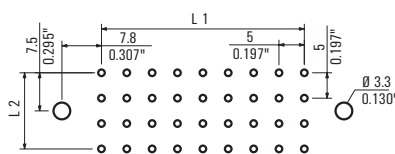

Additional deratings curves

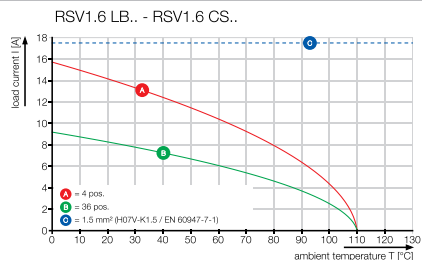

RSV1.6 CS.. & CB..



Rectangular plug-in connector for use with crimp contacts. Can be used as universal coupling, but also with the PCB variations. The crimp contacts guarantee a high connection density. The CS 1.6 or CB 1.6 contacts are used here. The connectors can be coded and locked together with their mates. Supplied in cardboard box.

Technical data

In compliance with IEC 60664-1 / IEC 61984			
Clamping range, max.	mm ²	0.13...3.31	
Solid core H05(07) V-U	mm ²		
Stranded H07 V-R		0.2...2.5	
Flexible H05(07) V-K	mm ²		
Flexible with ferrule	mm ²		
Ferrule with plastic collar	mm ²		
Stripping length	mm	4	
Screwdriver blade	mm		
According to norm			
Tightening torque range	Nm		
Rated current, max.	A	17	15
At ambient temperature		20°C	40°C
For conductor cross-section	mm ²		
Overvoltage category		III	III II
Pollution severity		3	2 2
Rated voltage	V	250	400 630
Rated impulse voltage	kV	4	4 4
UL / CUL (Use Group)		B	C D
Rated voltage	V		
Rated current	A		
AWG conductor	AWG		
CSA (Use Group)		B	C D
Rated voltage	V	600	
Rated current	A	13	
AWG conductor	AWG	26-12	
General data			
Type of insulation material		Wemid (PA)	
UL 94 flammability rating		V-0	
Contact base material		Copper alloy	
Material of contact surface			
Pin dimensions = d	mm		
Solder eyelet Ø = D	mm		
Solder eyelet Ø tolerance	mm		

Product data

IEC: 630 V / 17 A
UL: 600 V / 10 A / AWG 26 - 12

For additional articles and information, refer to catalog.weidmueller.com

Note:

- Additional colours on request
- Rated current related to rated cross-section & min. No. of poles.
- Spacing between rows: see hole layout
- Rated cross-section depends on crimp contact used.
- Rated data refer only to the component itself. Clearance and creepage distances to other components are to be designed in accordance with the relevant application standards.
- Max. outer diameter of the cable (with insulation): 3.5 mm

RSV1.6 CS..



Dimensioned drawing

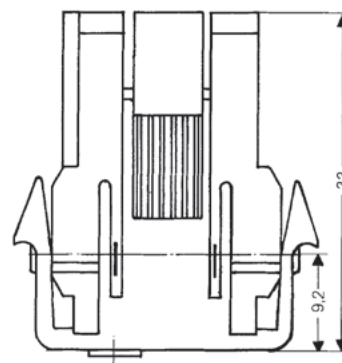

Ordering data

Solder pin length					
Colour	Pebble grey				
Pitch	5.00 mm				
Pol.	L1	(inch)	Qty.	Order No.	
4	5.00	0.197	25	1413100000	
6	10.00	0.394	25	1414100000	
9	10.00	0.394	25	1415100000	
12	15.00	0.591	25	1416100000	
18	25.00	0.984	25	1417100000	
24	25.00	0.984	20	1418100000	
36	40.00	1.575	10	1419100000	

Accessories

Note: Refer to the Accessories chapter for additional accessories.

Release tool	DW RSV 1.6	9004530000
Crimping tool	HTF RSV 16 WI	9013560000
Clip-in foot	RSV1,6 RF12/35x15 SW	1690140000
	RSV1,6 RF12/35x7.5 SW	1582940000
	RSV1,6 RF18/35x15 SW	1690150000
	RSV1,6 RF18/35x7.5 SW	1582950000
	RSV1,6 RF24/35x15 SW	1690160000
	RSV1,6 RF24/35x7.5 SW	1582960000
	RSV1,6 RF36/35x15 SW	1690170000
	RSV1,6 RF36/35x7.5 SW	1582970000
	RSV1,6 RF4/35x15 SW	1690110000
	RSV1,6 RF4/35x7.5 SW	1582910000
	RSV1,6 RF6/35x15 SW	1690120000
	RSV1,6 RF6/35x7.5 SW	1582920000
	RSV1,6 RF9/35x15 SW	1690130000
	RSV1,6 RF9/35x7.5 SW	1582930000
Strain relief	RSV1,6 ZE 12 SW	1563300000
	RSV1,6 ZE 18 SW	1563200000
	RSV1,6 ZE 24 SW	1563100000
	RSV1,6 ZE 36 SW	1563000000
	RSV1,6 ZE 4 SW	1563600000
	RSV1,6 ZE 6 SW	1563500000
	RSV1,6 ZE 9 SW	1563400000
Coding	RSV1,6 KO	1567430000

Representative deratings curve

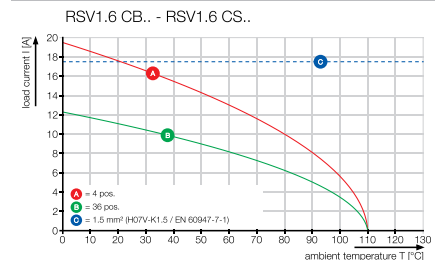

RSV1.6 CB..



Dimensioned drawing

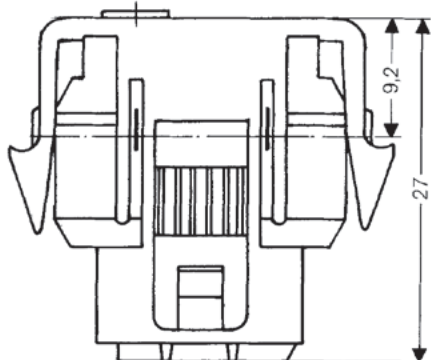

Ordering data

Solder pin length				
Colour				Pebble grey
Pitch 5.00 mm				
Pol.	L1	(inch)	Qty.	Order No.
4	5.00	0.197	25	1413000000
6	10.00	0.394	25	1414000000
9	10.00	0.394	25	1415000000
12	15.00	0.591	25	1416000000
18	25.00	0.984	25	1417000000
24	25.00	0.984	20	1418000000
36	40.00	1.575	10	1419000000

Mounting cutout

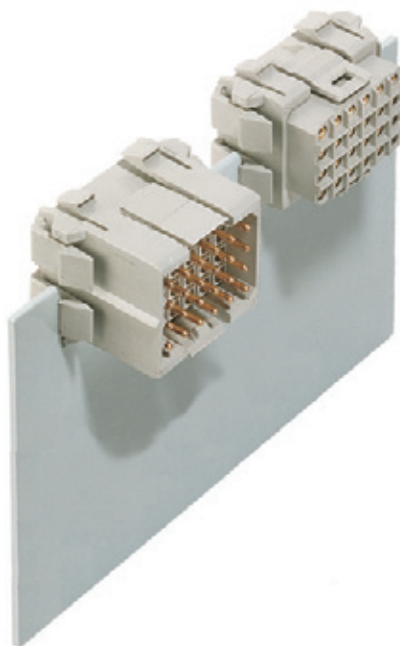

- Spring clips ensure firm hold in enclosure wall

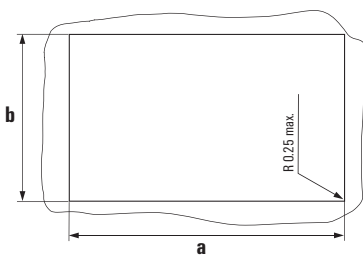

Mounting cutout for enclosure RSV 1.6
Wall thickness 1.5...2.0 mm

No. of poles	Dim. a (mm)*	Dim. b (mm)*
4	20.3	17.8
6	25.1	18.1
9	25.1	24.0
12	30.0	24.0
18	40.5	24.0
24	40.5	28.3
36	55.5	28.3

*) Tolerance: +0.3 mm

OMNIMATE Signal Accessories

OMNIMATE Signal Accessories	Strain relief	D.2
	Snap-on foot	D.3
	Covers	D.4
	Locks / Fixing blocks	D.5
	Light guides	D.8
	Coding elements	D.10
	Dividing element	D.11
	Separator plates	D.12
	Disconnect element	D.13
	Fuse element	D.13
	Marker carrier	D.14
	LED holder	D.14
	Cross-connector	D.15
	Test plug	D.15
	Identification systems	D.16
	IDC assembly blocks	D.19
	Crimping tools	D.20
	Disengaging tool / Removal tool	D.21
	Screwdrivers	D.22

Strain relief

**BL 3.50 ZE
BLZF 3.50 ZE**

Strain relief



- Supports and protects the cable connections when removing the plug-in connector and during normal operation.
- Helpful when inserting and removing plug-in connector.

**BLZ 5.00 ZE
BLZ 5.08 ZE**

Strain relief



- Supports and protects the cable connections when removing the plug-in connector and during normal operation.
- Helpful when inserting and removing plug-in connector.

BLT ZE

Strain relief



- Supports and protects the cable connections when removing the plug-in connector and during normal operation.
- Helpful when inserting and removing plug-in connector.

D

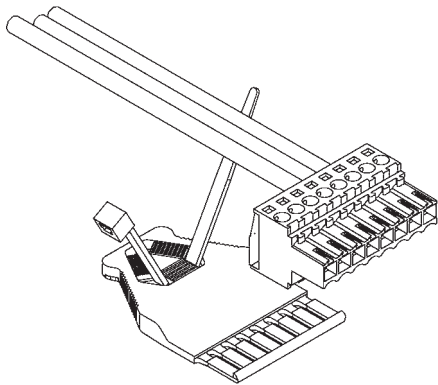

Ordering data

Colour		orange	black
No. of poles	Qty.	Order No.	Order No.
from 3	50	1629680000	1627820000
from 8	50	1629690000	1627830000

Ordering data

Colour		orange	black
No. of poles	Pitch (mm)	Qty.	Order No.
from 4	5,00	50	1652100000
from 8	5,00	50	1652040000
from 4	5,08	50	1652110000
from 8	5,08	50	1652050000

Ordering data

Colour		orange
No. of poles	Qty.	Order No.
from 4	50	1577980000
from 9	50	1578010000

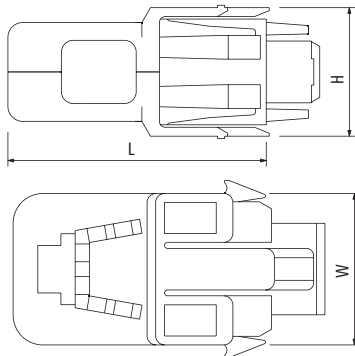
RSV ZE**Strain relief****Ordering data**

Pole	W (mm)	L (mm)	H (mm)	Qty.	Order No.
4	20,50	39,00	22,20	10	1563600000
6	25,50	44,00	22,40	10	1563500000
9	25,50	44,00	28,40	10	1563400000
12	33,00	51,50	28,60	10	1563300000
18	40,00	58,50	28,60	10	1563200000
24	40,00	58,50	28,60	10	1563100000
36	55,00	73,50	32,60	10	1563000000

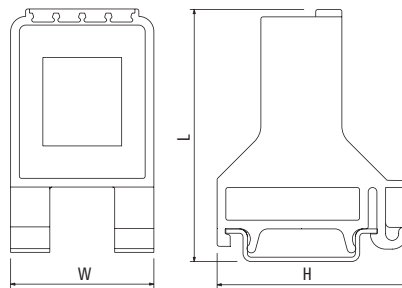
RSV RF**Snap-on foot for terminal rail****Ordering data**

Snap-on foot for TS 35 x 7.5					black
Pole	W (mm)	L (mm)	H (mm)	Qty.	Order No.
4	32,90	58,90	43,70	10	1582910000
6	32,90	58,90	43,70	10	1582920000
9	32,90	58,90	43,70	10	1582930000
12	32,90	58,90	43,70	10	1582940000
18	37,30	83,40	43,70	10	1582950000
24	37,30	83,40	43,70	10	1582960000
36	37,30	83,40	43,70	10	1582970000

Snap-on foot for TS 35 x 15				
Pole	W (mm)	L (mm)	H (mm)	Order No.
4	32,90	65,40	43,70	1690110000
6	32,90	65,40	43,70	1690120000
9	32,90	65,40	43,70	1690130000
12	32,90	65,40	43,70	1690140000
18	37,30	90,90	43,70	1690150000
24	37,30	90,90	43,70	1690160000
36	37,30	90,90	43,70	1690170000

B2L 3.50 AH

Cover

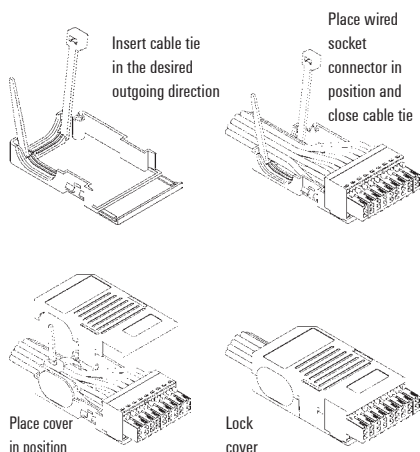
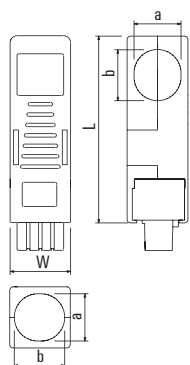

Ordering data

Pole	W (mm)	L (mm)	a (mm)	b (mm)	Qty.	Order No.
6	10,50	39,80	9,55	8,00	10	1781560000
8	14,00	39,80	9,55	8,00	10	1781570000
10	17,50	39,80	13,60	9,00	10	1781580000
12	21,00	39,80	13,60	9,00	10	1781590000
14	24,50	39,80	13,60	20,00	10	1781600000
16	28,00	39,80	13,60	20,00	10	1781610000
18	31,50	53,80	13,60	20,00	10	1781620000
20	35,00	53,80	13,60	20,00	10	1781630000
22	38,50	53,80	13,60	20,00	10	1781640000
24	42,00	53,80	13,60	20,00	10	1781650000
26	45,50	53,80	13,60	20,00	10	1781660000
28	49,00	53,80	13,60	20,00	10	1781670000
30	52,50	53,80	13,60	20,00	10	1781680000
32	56,00	53,80	13,60	20,00	10	1781690000
34	59,50	53,80	13,60	20,00	10	1781700000
36	63,00	53,80	13,60	20,00	10	1781710000

BL 3.50 AH

Cover

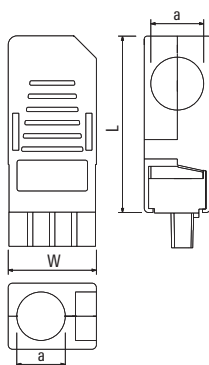

Ordering data

Pole	W (mm)	L (mm)	a (mm)	b (mm)	Qty.	Order No.
2	-	-	-	-	-	-
3	10,50	30,00	8,50	-	10	1745580000
4	14,00	30,00	8,50	-	10	1745590000
5	17,50	30,00	8,50	-	10	1745600000
6	21,00	30,00	8,50	-	10	1745610000
7	24,50	40,00	11,00	-	10	1745620000
8	28,00	40,00	11,00	-	10	1745630000
9	31,50	40,00	11,00	-	10	1745640000
10	35,00	40,00	11,00	-	10	1745650000
11	38,50	40,00	11,00	-	10	1745660000
12	42,00	40,00	11,00	-	10	1745670000
13	45,50	40,00	11,00	-	10	1745680000
14	49,00	40,00	11,00	-	10	1745690000
15	52,50	40,00	11,00	-	10	1745700000
16	56,00	40,00	11,00	-	10	1745710000

BCZ 3.81 AH

Cover

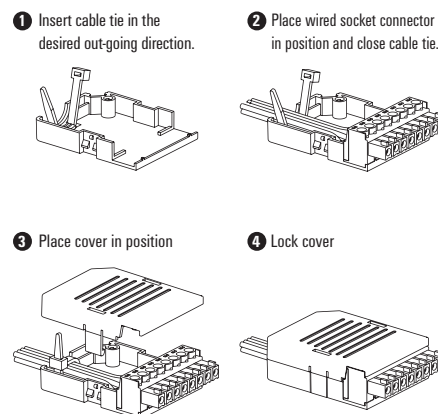
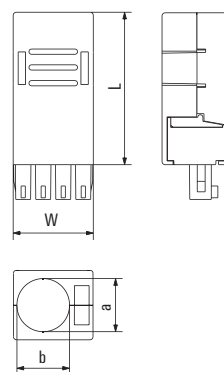

Ordering data

Pole	W (mm)	L (mm)	a (mm)	b (mm)	Qty.	Order No.
2	-	-	-	-	-	-
3	11,43	29	10	10	10	1005280000
4	15,24	29	10	10	10	1005290000
5	19,05	29	10	10	10	1005300000
6	22,86	29	10	10	10	1005310000
7	26,67	39	10	12,5	10	1005320000
8	30,48	39	10	12,5	10	1005330000
9	34,29	39	10	12,5	10	1005340000
10	38,1	39	10	13	10	1005350000
11	41,91	39	10	13,8	10	1005360000
12	45,72	39	10	14,6	10	1005370000
13	49,53	39	10	15,4	10	1005380000
14	53,34	39	10	16,2	10	1005390000
15	57,15	39	10	17	10	1005400000
16	60,96	39	10	17,8	10	1005410000

BL/SL 3.50 VR

Lock



- Simple, screw-less, vibration-proof mechanism for all single-row male connectors in conjunction with the standard 180° screw terminal socket connector BL 3.5.
- 2 VR locks are recommended for plug-in connectors with more than 8 poles.

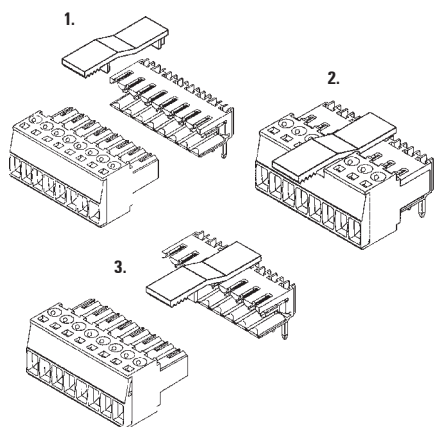

Ordering data

Colour		orange	black
No. of poles	Qty.	Order No.	Order No.
BL/SL 3.50 VR	100	1669310000	1669300000

SLDF VR

Lock



- For vibration-proof plug-in connections
- Socket must be B-Version with dovetail

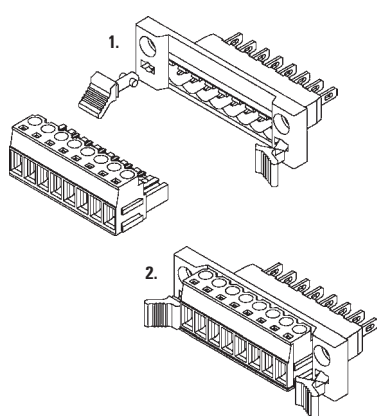

Ordering data

Colour		black
Type	Qty.	Order No.
SLDF VR	100	1599120000

BBDF

for universal feed-through-connection



Assembly Instruction

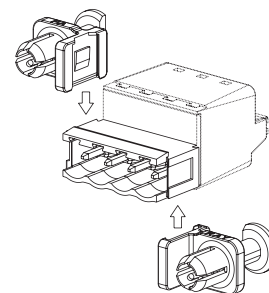

view of BBDF inside the panel

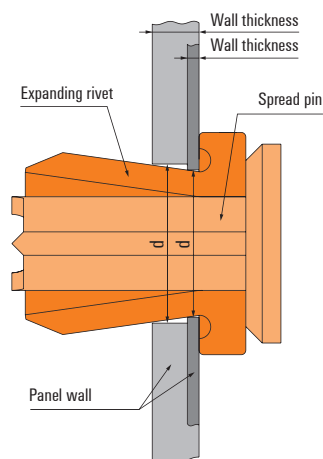

Ordering data

Colour		orange	black	
Type	Width (mm)	Qty.	Order No.	Order No.
BBDF	9,5	100	1307570000	1307580000

SLA BB1R
SLA BB11R

Mounting blocks for headers, in 5.0x-mm pitch

SLA BB11R



SLA BB1R

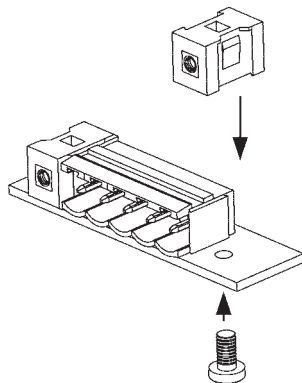
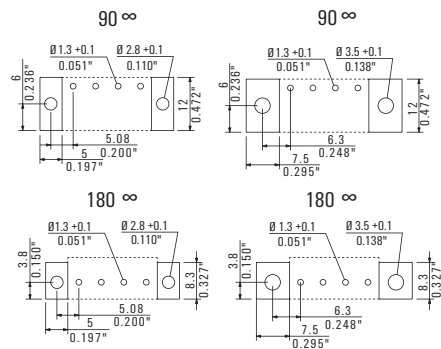

SLA BB2R
SLA BB12R

Mounting blocks for plugs, in 5.0x-mm pitch

SLA BB12R



SLA BB2R

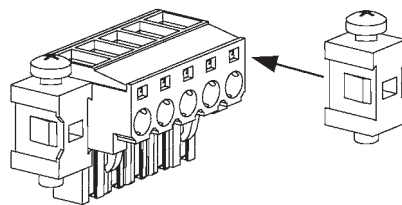

SL 135 BB15R

Mounting blocks for SL 135 male header

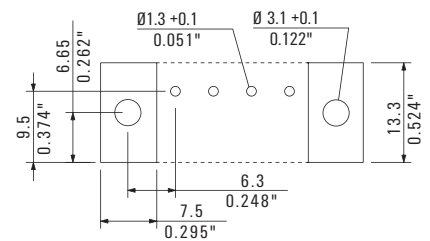

Ordering data

Colour		orange	black
Type	Width (mm)	Qty.	Order No.
SLA BB1R	7,5	20	1723430000
SLA BB11R	5,0	100	1604120000

Ordering data

Colour		orange	black
Type	Width (mm)	Qty.	Order No.
SLA BB2R	7,5	20	1723440000
SLA BB12R	5,0	100	1593450000

Ordering data

Colour		orange	black
Type	Width (mm)	Qty.	Order No.
SL135 BB15R	7,5	20	1606450000

SLA BB14

Mounting blocks for SLD 5.08 headers

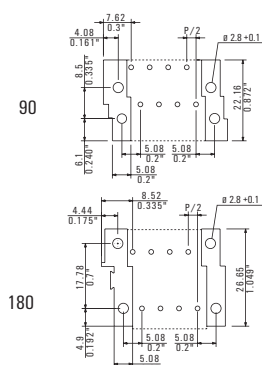
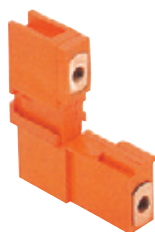

- Provides additional mechanical support for rows of male connectors on the PCB
- Also enables vibration-proof connections for the matching socket connectors.
- BB12 fixing blocks or an integral screw flange are required for the socket.
- Caution: Only to be used with SLD 5.08 90 / SLD 5.08 180.

Ordering data

Colour		orange	black
Type	Width (mm)	Qty.	Order No.
SLA BB14	5,0	20	1594200000
			1774460000

LPBB

PCB fixing block

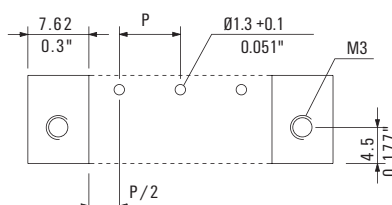

- Provides additional mechanical support for terminals LP, LP1N and LP 1H.
 - Can also be supplied with captive nut (LPBB MU).
- Ordering

Ordering data

Colour		orange	black
Type	Qty.	Order No.	Order No.
LPBB	100	1747540000	1747560000
LPBB MU	100	1747530000	1747550000

TOP 1.5 BB

Fixing block for TOP 1.5 GS terminals

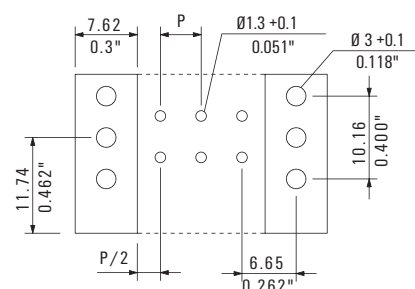

- Provides additional mechanical support for TOP 1.5 GS terminals.
- Supplied complete with 2.9 x 19 mm self-tapping screw.

Ordering data

Colour		orange	black
Type	Qty.	Order No.	Order No.
TOP1.5 BB	20	1539860000	

S2L FLA

Light guide

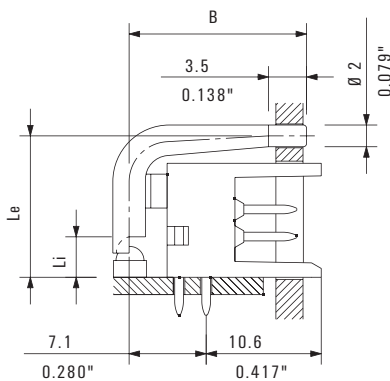
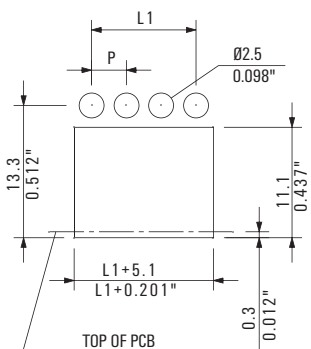

Ordering data

Pole	Li (mm)	Le (mm)	B (mm)	Qty.	Order No.
10	3,70	13,00	16,35	100	1699580000

S2L-SMT FLA

Light guide

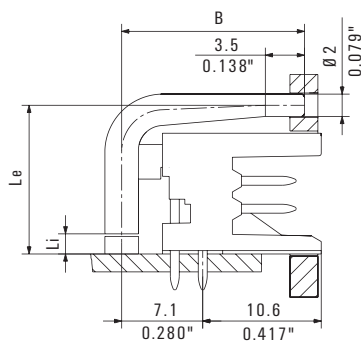
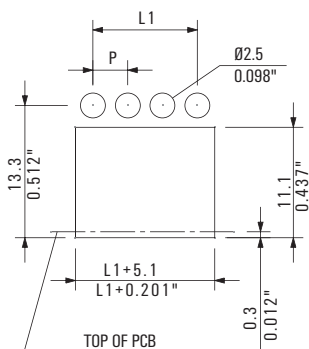

Ordering data

Pole	Li (mm)	Le (mm)	B (mm)	Qty.	Order No.
10	1,80	13,30	16,35	50	1814590000

SL 3.50 FLA

Light guide

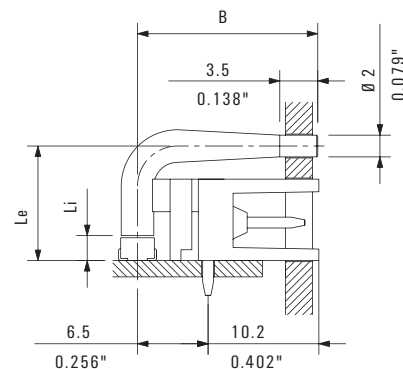
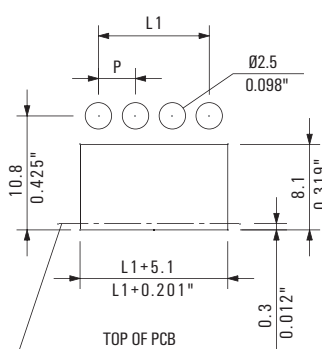

Ordering data

Pole	Li (mm)	Le (mm)	B (mm)	Qty.	Order No.
8	1,50	10,55	16,60	50	1597510000
8	2,30	10,55	16,60	50	1597520000
8	4,00	10,55	16,60	50	1597530000
8	1,50	10,55	14,85	50	1597630000
8	2,30	10,55	14,85	50	1597640000
8	4,00	10,55	14,85	50	1597650000

SC 3.81 FLA

Light guide

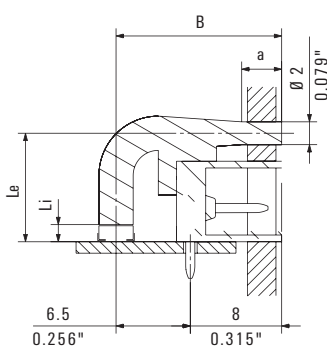
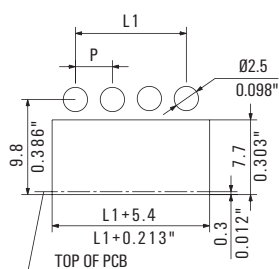

Ordering data

Pole	Li (mm)	Le (mm)	B (mm)	Qty.	Order No.
8	1,5	9,50	14,25	50	1979730000
8	2,3	9,50	14,25	50	1979750000
8	1,5	9,50	16,00	50	1979720000
8	2,3	9,50	16,00	50	1979740000

SL 5.08 FLA

Light guide

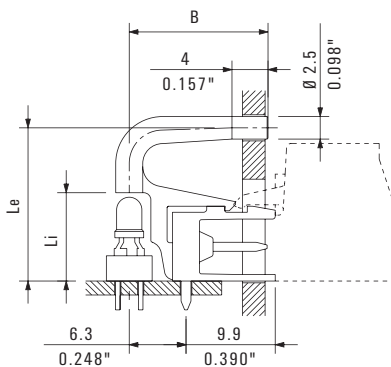
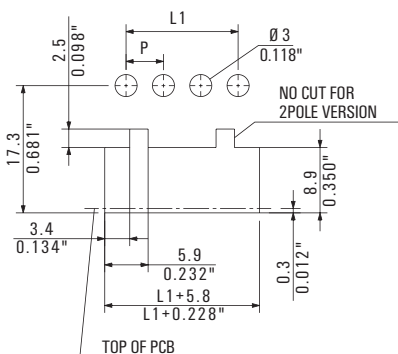

Ordering data

Pole	Li (mm)	Le (mm)	B (mm)	Qty.	Order No.
1	1,50	17,00	15,40	100	1580100000
1	2,30	17,00	15,40	100	1636670000
1	3,80	17,00	15,40	100	1580110000
1	9,00	17,00	15,40	100	1580120000
24	1,50	17,00	15,40	10	1595850000
24	2,30	17,00	15,40	10	1636680000
24	3,80	17,00	15,40	10	1595860000
24	9,00	17,00	15,40	10	1595870000

Coding elements

B2L/S2L KO

Coding element



- For coding plug-in connectors to prevent errors during installation.
- Suitable for plug and socket connectors.
- The coding does not block any poles.

BL/SL 3.50 KO

Coding element



- For coding plug-in connectors to prevent errors during installation.
- Suitable for plug and socket connectors.
- The coding does not block any poles.

SC-SMT 3.81 KO

Coding element



- For coding connectors in order to prevent mistakes during installation
- Only for male headers (SC 3.81 and SC-SMT 3.81).
- Female headers (BCZ 3.81, BCF 3.81 and BCL-SMT 3.81) are coded using diagonal-cutting pliers. The coding does not occupy a pole.

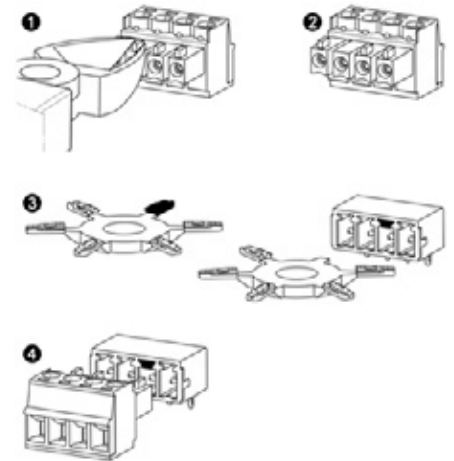
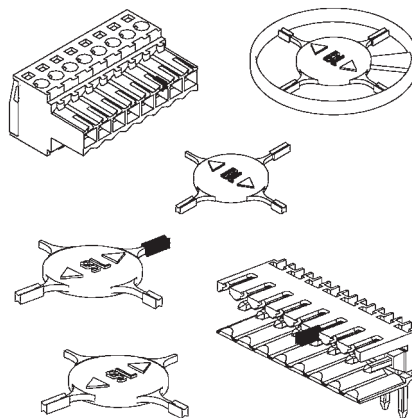

Ordering data

Colour	orange	black	
Type	Qty.	Order No.	Order No.
B2L/S2L KO	100	1849730000	1849740000

Ordering data

Colour	orange	black	
Type	Qty.	Order No.	Order No.
BL/SL 3.50 KO	100	1693430000	1610100000

Ordering data

Colour	grey	
Type	Qty.	Order No.
SC-SMT 3.81 KO GR	100	1968900000

1 unit = 6 coding elements

BLZ/SL KO

Coding element



- For coding plug-in connectors to prevent errors during installation.
- Suitable for plug and socket connectors.
- The coding does not block any poles.
- Coding element for the BL/SL 5.00 and BL/SL 5.08 series

RSV 1.6 KO

Coding element



- For coding plug-in connectors to prevent errors during installation.
- Suitable for plug and socket connectors.
- The coding blocks individual poles.

SLAT

Dividing element



- Subdivides male connectors into distinct segments.
- Prevents errors during installation.



Ordering data

Colour		orange	black
Type	Qty.	Order No.	Order No.
BLZ/SL KO	100	1573010000	1545710000

Ordering data

Colour		black
Type	Qty.	Order No.
RSV 1.6 KO	50	1567430000

Ordering data

Colour		orange	black
Type	Qty.	Order No.	Order No.
SLAT	100	1598300000	1770240000

LPZP 1.27/90

Separator plates

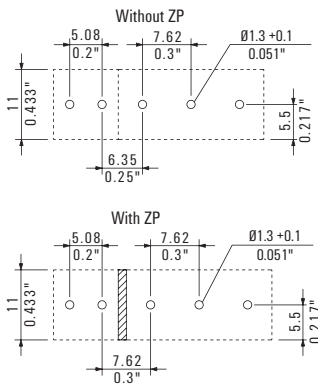

- Spacer plate for separating connections with different voltages and pitches.

LPZP 2.54/90

Separator plates

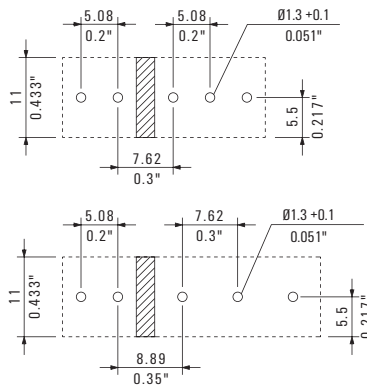

- For clear identification of phases in adjacent connections.
- Spacer plate for separating connections with different voltages and pitches.

LPZP 2.54/135

Separator plates

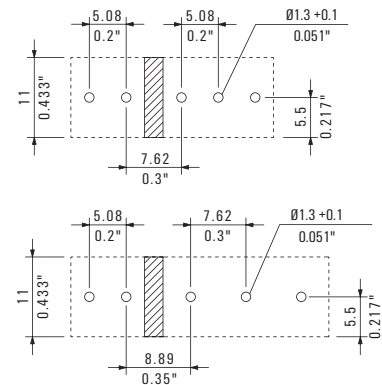

- For clear identification of phases in adjacent connections.
- Spacer plate for separating connections with different voltages and pitches.

Ordering data

Colour	orange	black	
Type	Qty.	Order No.	Order No.
LPZP 1.27/90	100	1747490000	1747510000

Ordering data

Colour	orange	black	
Type	Qty.	Order No.	Order No.
LPZP 2.54/90	100	1747480000	1747500000

Ordering data

Colour	orange	black	
Type	Qty.	Order No.	Order No.
LPZP 2.54/135	100	1753740000	1753750000

LPZP1N 2.54

Separator plates

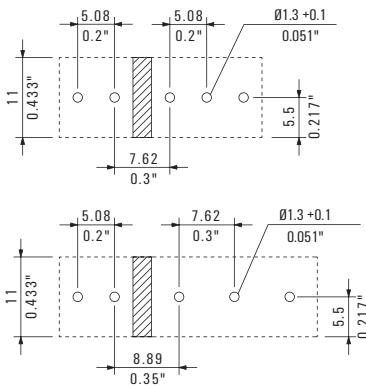

- For clear identification of phases in adjacent connections.
- Spacer plate for separating connections with different voltages and pitches.

Ordering data

Colour	orange	black	
Type	Qty.	Order No.	Order No.
LPZP1N 2.54	100	1747470000	1747520000

LPA TR

Disconnect element

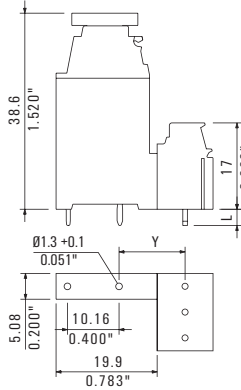

Technical data

	VDE	UL	CSA
Rated voltage	250 V	300 V	300 V
Rated current	9 A	10 A	10 A

- Can be fixed to the rear of all LP 90 terminals.
- DEKAFIX markers not included.

Ordering data

Type	Y (mm)		Qty.	Order No.
	with LP	with LPP		
LPA TR	12,8	15,2	100	1495460000

LPA SI

Fuse element

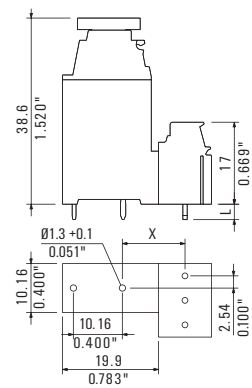

Technical data

	VDE	UL	CSA
Rated voltage	250 V	300 V	300 V
Rated current	6,3 A	10 A	10 A

- Can be fixed to the rear of all LP 5.08/90 terminals.
- Takes 5 x 25 cartridge fuses (DIN 820, IEC 127-2).
- Power loss = 1.6 W
- DEKAFIX markers not included.

Ordering data

Type	Y (mm)		Qty.	Order No.
	with LP	with LPP		
LPA SI	12,8	15,2	50	1495060000

LPA BZ

Marker carrier

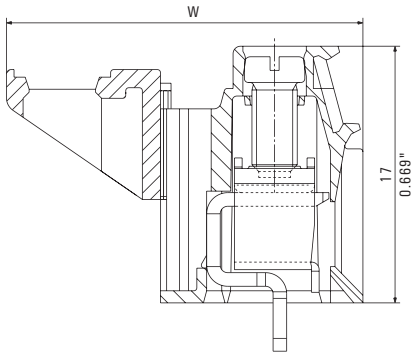

- For better marking of the connection clamps of the LP series
- Simply fixed to the back of the terminal.
- The WS 10/5 and WS 12/5 markers are not included with the delivery. Refer to the chapter on Accessories: Labelling Cards
- LEDs not included.

Ordering data

Pole	Colour	Width W		Qty.	black
		with LP	with LPP		Order No.
2	LPA BZ2	21,2	23,6	100	1497260000
3	LPA BZ3	21,2	23,6	100	1497360000

LPA FA

LED holder

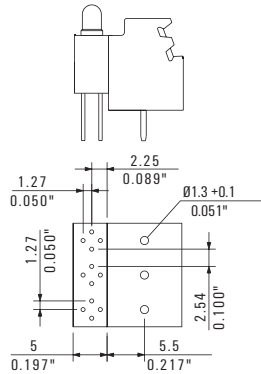

- Holder for standard 3 mm LEDs.
- Raised mounting position improves visibility of LEDs.
- Simply fixed to the back of the terminal.
- LEDs not included.

Ordering data

Pole	Colour	Qty.	black
			Order No.
2	LPA FA 2	50	1495960000
3	LPA FA 3	50	1496060000

LPA FA BZ

LED holder with marker carrier

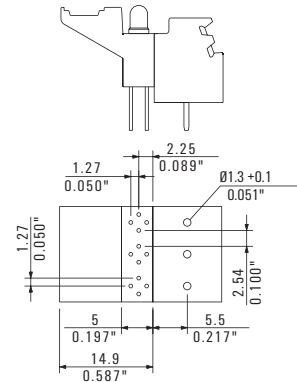

- For additional marking and fixing of three LEDs.
- Simply fixed to the back of the terminal.
- The WS 10/5 and WS 12/5 markers are not included with the delivery. Refer to the chapter on Accessories: Labelling Cards
- LEDs not included.

Ordering data

Pole	Colour	Qty.	black
			Order No.
2	LPA FA BZ2	50	1496160000
3	LPA FA BZ3	50	1496260000

LPA QB

Cross-connector

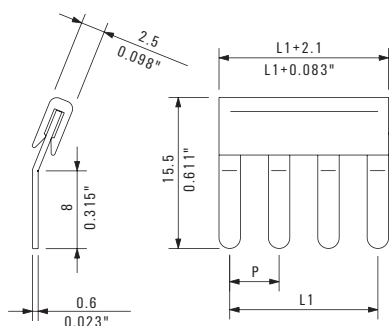

- For distributing potential after installation.
- Reduces the feasible conductor diameter to the next smaller cross-section.
- Not suitable for use with tension clamp spring connection.

Ordering data

Pole	Pitch	Type	Qty.	Order No.
2	5,08 mm	LPA QB2	50	1472200000
3	5,08 mm	LPA QB3	50	1472300000
4	5,08 mm	LPA QB4	50	1472400000
10	5,08 mm	LPA QB10	20	1472500000
17	5,08 mm	LPA QB17	20	1584770000
24	5,08 mm	LPA QB24	20	1472600000

PS 2.0 MC

Test plug

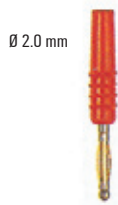

- For conductors up to 0.75 mm² (AWG 18).
- Gold-plated lantern-type contact.
- Conductor must be soldered to contact in test plug.

Ordering data

Type	Conductor size	Qty.	Order No.
PS 2.0 MC	≤ 0,75 mm ²	20	0310000000

KSW 4 / KSW 2.5

Marking strips



KSW marking strips are suitable for labelling multi-pole PCB terminals and connectors. The white, self-adhesive strips are made from a non-PVC, environmentally friendly material. These marking strips provide individual printing, i.e. are suitable for every pitch. Available in two widths: 2.5 and 4.0 mm.

Printed strips

KSW 4		Pitch			
Char.	3,50 mm	5,00 mm	5,08 mm	7,62 mm	
1-8	1630190001	1700670001	1630200001	1700680001	
1-12	-	-	-	1652270001	
1-16	1630150001	1700700001	1630160001	-	
1-24*	1640410001	1700710001	1630180001	-	

KSW 2.5		Pitch			
Char.	3,50 mm	5,00 mm	5,08 mm	7,62 mm	
1-8	-	1700660001	1630100001	-	
1-12	-	-	-	-	
1-16	1652260001	1630070001	1713970001	-	
1-24*	1652250001	1713980001	1713990001	-	

Technical data

Material data	
Material	polyester with white surface
Adhesive	acrylic base
Temperature range	-40 °C to +150 °C
Min. bonding temperature	+4 °C
Flammability	self-extinguishing after 15 s

No. of marking strips per sheet	
up to 20 poles = 20 strips per sheet	
* more than 20 poles = 15 strips per sheet	

Ordering example	
Order No. 1630060001	

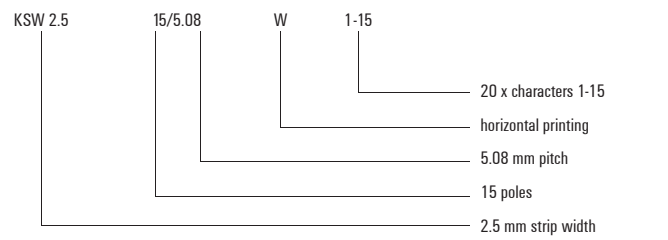

Blank strips

	Length of strip		
	50 mm	100 mm	150 mm
KSW 4	1629970000	1629990000	1630010000
KSW 2.5	1629960000	1629980000	1630000000

Custom printing to specification

	Length of strip		
	50 mm	100 mm	150 mm
KSW 4	1629910000	1629930000	1629950000
KSW 2.5	1629900000	1629920000	1629940000

Direct printing



We can also print directly on your plug and socket connectors to your specification. Please ask for details.

DEK 5

Dekafix system

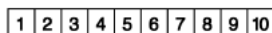

Horizontal printing

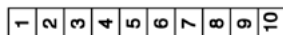

Vertical printing

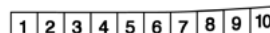

Mounted as strip



Mounted singly

Dekafix is supplied in packs of 10 cards with 50 individual tags per card.

Dekafix tags are white with black printing as standard.

Technical data

Material data	
Material	polyamide
Temperature range	- 40 °C to +100 °C
Flammability rating	UL 94 V-2
Contents	silicone-free, halogens below minimum detectable level self-extinguishing after 15 s
Mounting	as strips or singly depending on type of carrier
Printing	black printing, standard or to customer specification
Smudge resistance	to DIN IEC 50
Custom printing	according to list or data exchange by diskette or modem
Colour	to international colour code
Max. characters DEK 5	3 horizontal/3 vertical up to 2.5 mm font size

Custom printing to specification

Colour	Order No.	Colour	Order No.	Colour	Order No.	Qty. 500
○ white	0490760000	(Note: white has a different order No; otherwise, please state colour when ordering.)				
● black	0490790000	● yellow	0490790000	● violet	0490790000	
● brown	0490790000	● green	0490790000	● grey	0490790000	
● red	0490790000	● blue	0490790000	● orange	0490790000	

Blank

Colour	Order No.	Colour	Order No.	Colour	Order No.	Qty. 500
● black	0473391694	● yellow	0473391687	● violet	0473391689	
● brown	0473391692	● green	0473391688	● grey	0473391691	
● red	0473391686	● blue	0473391693	○ white	0473360000	
● orange	0473391690					

Printed tags

(horizontal only)	Character	Order No.	Character	Horizontal	Vertical
Tags with individual letters	A	0522761021	Beschriftung je 50 Zahlen fortlaufend	1 ... 50	0473460001
	B	0522761022	1 2 3 4 5 6 7 8 9 10	51 ... 100	0473460005
	C	0522761023	11 12 13 14 15 16 17 18 19 20	to	The last 3 digits of the order No. indicate the first character.
	D	0522761024		951 ... 999	0473460095
	E	0522761025	10 consecutive numbers	1 ... 10	0523060001
	F	0522761026	1 2 3 4 5 6 7 8 9 10	11 ... 20	0523060011
	G	0522761027	11 12 13 14 15 16 17 18 19 20	to	The last 3 digits of the order No. indicate the first character.
	H	0522761028		91 ... 100	0523060091
	I	0522761029	Individual numbers	1	0522660001
	J	0522761030	1 1 1 1 1 1 1 1 1 1	2	0522660002
	K	0522761031		bis	The last 3 digits of the order No. indicate the first character.
	L	0522761032		200	0522660200
	M	0522761033	Various symbols	L1, L2, L3, N, PE	0354361187
	N	0522761034	L1 L2 L3 N PE L1 L2 L3 N PE		
	O	0522761035			
	P	0522761036	Single symbols	plus +	0576261198
	Q	0522761037	+ + + + + + + +	minus -	0576261199
	R	0522761038	L1 L1 L1 L1 L1 L1 L1 L1 L1 L1	PE	-
	S	0522761039		L1	0522361075
	T	0522761040		L2	0522361076
	U	0522761041		L3	0522361077
	V	0522761042		earth	0576261202
	W	0522761043		earth in circle	0576261203
	X	0522761044		AC ~	0576261215
	Y	0522761045			
	Z	0522761046			
			Individual card (state characters and orientation when ordering)	0490760000	0490760000
			Coloured blank Dekafix (state colour when ordering)	0473390000	0473390000
			Coloured printed Dekafix = custom printing (state colour and characters when ordering)	0490790000	0490790000

WS 10/5
WS 12/5

MultiCard marking



S 10

Marker strips



- WS 10/5 = 10 mm long x 5 mm wide
- WS 12/5 = 12 mm long x 5 mm wide
- Supplied as MultiCard 5 cards each with 144 markers

- Markers for TOP 4 terminals
- Supplied in packs of 100 strips with 10 markers per strip

Ordering data

Type	Length mm	Order No.
WS 10/5	10	1635000000
WS 12/5	12	1609860000

Ordering data

Printing	Qty.	Order No.
10 consecutive numbers (SF10)	0 ... 9	0332400000
	1 ... 10	0331500001
	11 ... 20	0331500011
Individual numbers (SF 10)	1	0332500001
	2	0332500002
	3	0332500003
	4	0332500004
	5	0332500005
	6	0332500006
	7	0332500007
	8	0332500008
	9	0332500009
Blank		0332500000
Custom printing on request*		

* A minimum order quantity can be agreed for custom printing.

BLIDC B 3.5 ASB

IDC assembly block



Wiring the module

1. Insert conductor as far as possible.

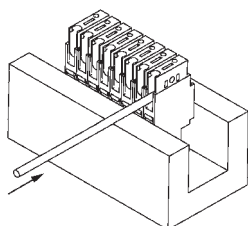

2. Insert screwdriver into centre opening and press down.

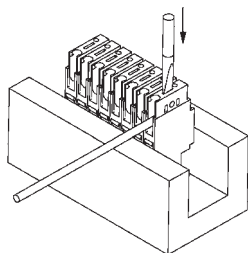

3. Module is engaged and conductor is now connected.

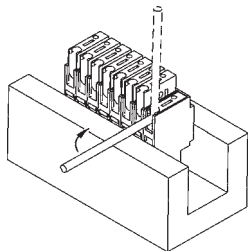

Detaching the module

1. Insert screwdriver into first opening and press down.

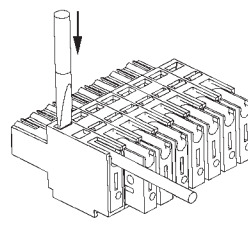

2. Insert screwdriver into second opening and press down.

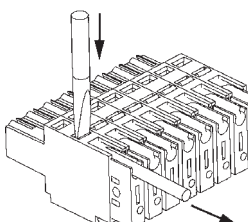

3. Module is now disengaged and can be pulled out.

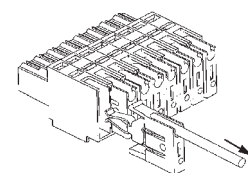

Ordering data

Type	Qty.	Order No.
BLIDCB 3.5	1	1770310000

Crimping tools

HTF 28 HTF 63

Crimping tools

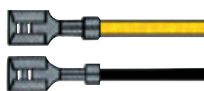

- Precision crimping tool with ratchet for 2.80 and 6.30 mm spade connections with open or rolled terminals
- HTF 28 for flexible conductors 0.10-1.00 mm² (AWG 26-16)
- HTF 63 for flexible conductors 0.50-2.50 mm² (AWG 20-14)

Ordering data

Type	Crimp size mm/inch	Cross-section mm ² /AWG	Order No.
HTF 28	2,8/0,110	0,14-1,5/26-16	9013090000
HTF 63	6,3/0,250	0,50-2,5/20-14	9013400000

HTF DFF

Crimping tools



- Precision crimping tool with ratchet for the Weidmüller DFFC crimp contacts of BLC and BLAC socket connectors
- 0.22-0.35 mm² (AWG 24-22)
- 0.50-1.00 mm² (AWG 20-17)
- 1.50-2.50 mm² (AWG 16-12)

Ordering data

Type	Cross-section mm ² /AWG	Order No.
HTF DFF	0,22-2,5/24-12	9014140000

HTF RSV 12 HTF RSV 16

Crimping tools



- Precision crimping tool with ratchet for the Weidmüller CB and CS crimp contacts of RSV 1.6 plug-in connectors
- RSV 16 = 0.14 - 1.50 mm² (AWG 26-16)
- RSV 12 = 1.50 - 2.50 mm² (AWG 14-12)

Ordering data

Type	Cross-section mm ² /AWG	Order No.
HTF RSV 16	0,14-1,5/26-16	9013560000
HTF RSV 12	1,50-2,5/14-12	9013550000

DFFC EW2

Disengaging tool

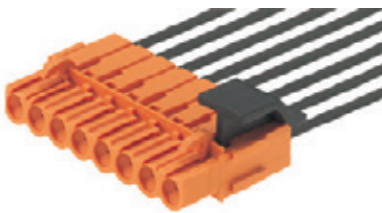

Ordering data

Type	Qty.	Order No.
DFFC EW2	1	1803790000

DW RSV

Disengaging tool

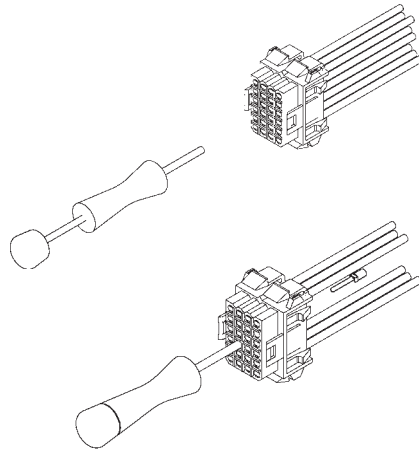

Ordering data

Type	Qty.	Order No.
DW RSV 1.6	1	9004530000

SDI

VDE-insulated slotted screwdriver

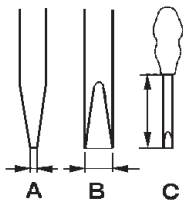

VDE-insulated slotted screwdriver, SDI

- DIN 7437, ISO 2380/2
- Output acc. to DIN 5264, ISO 2380/1
- SoftFinish® handle



Ordering data

Type	Dims. (mm)	A	B	C	Order No.
SDI	0,4	2,5	75		9008370000
SDI	0,5	3,0	100		9008380000
SDI	0,6	3,5	100		9008390000
SDI	0,8	4,0	100		9008400000
SDI	1,0	4,5	125		9008910000
SDI	1,0	5,5	125		9008410000
SDI	1,2	6,5	150		9008420000
SDI	1,6	8,0	175		9008430000

SD

Slotted screwdriver with round blade

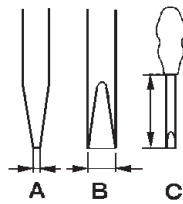

Slotted screwdriver with round blade, SD

- DIN 5265, ISO 2380/2
- Output acc. to DIN 5264, ISO 2380/1
- ChromTop tip
- SoftFinish® handle



Ordering data

Type	Dims. (mm)	A	B	C	Order No.
SD	0,4	2,5	75		9009030000
SD	0,5	3,0	80		9008320000
SD	0,6	3,5	100		9008330000
SD	0,8	4,0	100		9008340000
SD	0,8	4,5	125		9009020000
SD	1,0	5,5	150		9008350000
SD	1,2	6,5	150		9009010000

Tension clamp terminal tool

Tool for PCB terminals with tension clamp connection

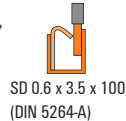
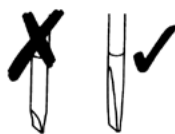

You do not need any special tool to connect or disconnect our tension clamp connection.

The opening is designed to accommodate a standard 0.6 x 3.5 x 100 screwdriver 9008330000 to DIN 5264-A (with flat blade).

SDK PH

Crosshead screwdriver



Crosshead screwdriver PH (Philips)

- SDK PH DIN 5262, ISO 8764/2-PH
- Output acc. to ISO 8764-PH
- ChromTop tip
- SoftFinish® handle



Crosshead screwdriver PZ (PoziDrive)

- SDK PZ DIN 5262, ISO 8764/2-PZ
- Output acc. to ISO 8764-PZ
- ChromTop tip
- SoftFinish® handle



Ordering data PH

Type	Dims. (mm)	A	B	C	Order No.
SDK PH0	0			60	9008470000
SDK PH1	1			80	9008480000
SDK PH2	2			100	9008490000
SDK PH3	3			150	9008500000

Ordering data PZ

Type	Dims. (mm)	A	B	C	Order No.
SDK PZ1	1			80	9008530000
SDK PZ2	2			100	9008540000
SDK PZ3	3			150	9008550000

OMNIMATE Power PCB terminals

OMNIMATE Power PCB terminals

Clamping yoke screw connection

Explanation	E.2
Quick selection	E.4
Technical data	E.6

OMNIMATE Power PCB terminals

High-power connections up to 150 A / 1.000 V

The OMNIMATE Power PCB terminals – ranging from the LUP in 10.16-mm pitch to the LXXX in 15.00-mm pitch – is approved for unlimited international use in applications according to UL 1059 (600 V) and IEC (1.000 V). Weidmüller's self-securing steel clamping yoke is 100 % maintenance free. It provides vibration-proof connections to the PCB for wires up to 50 mm².

E

Unrivalled clamping

With an unmatched clamping range, the LXXX 15.0 offers a safe and strong wire connection for cross-sections up to 50 mm² / AWG1 and 150 A to the circuit board.



Standard-compliant integration

Weidmüller terminals meet the extended creepage and clearance distances according to UL and finger safety in accordance with the IEC 61800-5-1 device standard.

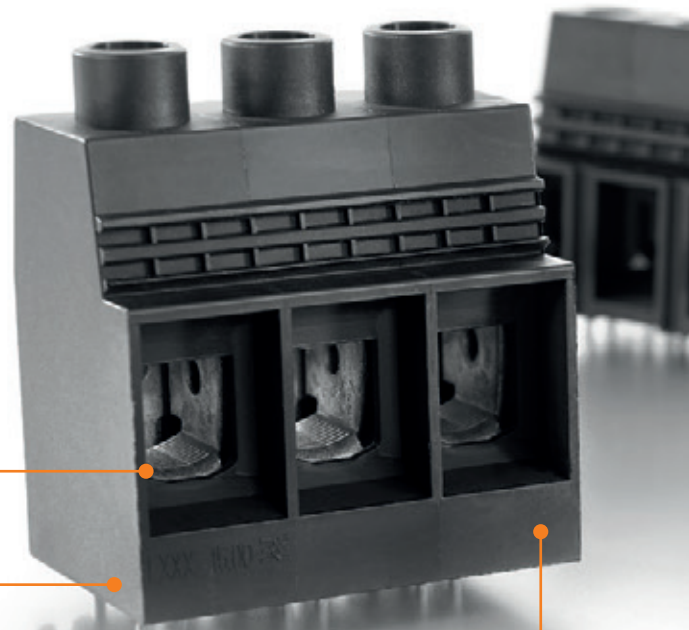

Power reserve for safety

The high-performance WEMID insulation material helps increase the availability of the system. With an RTI (relative temperature index) of 120 °C, the OMNIMATE Power PCB terminals exceed the upper continuous-use temperature recommended by the Standard PA (100 °C) by 20 °C. Thus there are more power reserves and improved safety in event of temperature fluctuations or overloads.

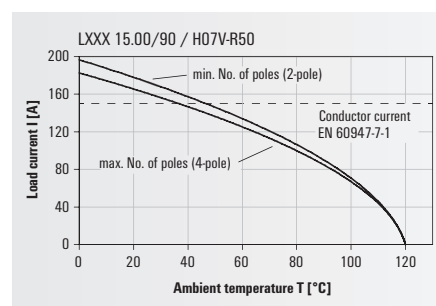

Wire protection

The integrated "Wire Guard" mechanism on the OMNIMATE Power PCB terminals prevents wires from being inserted improperly and prevents a malfunctioning contact.



Integrated test point

The required maintenance and measurements can be carried out in a safe, reliable and convenient manner.



Labelling and assigning

Terminals are available with custom direct printing, versatile Dekafix labelling, affordable adhesive strips and colour coding.









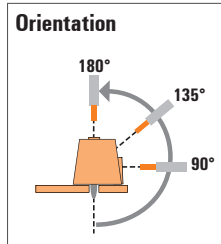

<http://www.OMNIMATE.net>

○ = 300 V (UL) / 1.000 V (IEC)

● = 600 V (UL) / 1.000 V (IEC)



PCB terminals

Type of connection	Clamping range	Type	IEC / UL	Page	90°	135°	180°
Screw Clamping yoke	≤ 16 mm ²	 LU 10.16	IEC: 1.000 V/76 A/0.5 - 16 mm ² UL: 300 V/65 A/AWG 26 - 6	E.6	●		
		 LUP 10.16	IEC: 1.000 V/76 A/0.5 - 16 mm ² UL: 300 V/58 A/AWG 26 - 6	E.7	●		
		 LUP 10.16/..90V*	IEC: 1.000 V/76 A/0.5 - 16 mm ² UL: 600 V/51 A/AWG 22 - 6	E.8	●		
		 LUP 12.70	IEC: 1.000 V/76 A/0.5 - 16 mm ² UL: 600 V/58 A/AWG 26 - 6	E.9	●		
	≤ 25 mm ²	 LX 15.00	IEC: 1.000 V/101 A/0.5 - 25 mm ² UL: 600 V/85 A/AWG 16 - 4	E.10	●		
		 LXB 15.00	IEC: 1.000 V/101 A/1.5 - 25 mm ² UL: 600 V/85 A/AWG 16 - 4	E.11	●		
	≤ 50 mm ²	 LXXX 15.00	IEC: 1.000 V/150 A/0.5 - 50 mm ² UL: 600 V/127 A/AWG 20 - 1	E.12	●		
		 LXXX 15.00/..90F	IEC: 1.000 V/150 A/0.5 - 50 mm ² UL: 600 V/127 A/AWG 20 - 1	E.13	●		

* With offset solder pins

LU 10.16/./90

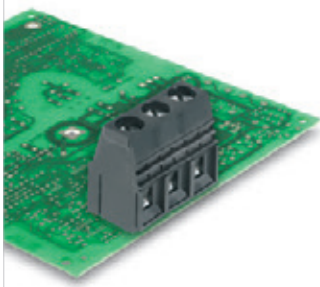

High-power PCB Terminal with clamping yoke screw connection, in 10.16 mm pitch for wire cross-sections up to 16 mm² (AWG 6).

- Increased derating reserves because WEMID insulating material is used.
- Wire outlet direction: 90° version.
- 2- and 3-pole block construction can be aligned together for higher pole counts.

Technical data

In compliance with IEC 60664-1 / IEC 61984			
Clamping range, max.	mm ²	0.14...16	
Solid core H05(07) V-U	mm²	0.5...16	
Stranded H07 V-R		6...16	
Flexible H05(07) V-K	mm ²	0.5...16	
Flexible with ferrule	mm ²	2.5...10	
Ferrule with plastic collar	mm ²	2.5...10	
Stripping length	mm	12	
Screwdriver blade	mm	1.0 x 5.5	
According to norm		DIN 5264	
Tightening torque range	Nm	1.2...1.5	
Rated current, max.	A	76	76
At ambient temperature		20°C	40°C
For conductor cross-section	mm ²	16	
Overvoltage category		III	III II
Pollution severity		3	2 2
Rated voltage	V	690	690 1000
Rated impulse voltage	kV	6	6 4
UL / CUL (Use Group)		B	C D
Rated voltage	V	300	150 300
Rated current	A	65	65 10
AWG conductor	AWG		26-6
CSA (Use Group)		B	C D
Rated voltage	V	300	150 300
Rated current	A	65	65 10
AWG conductor	AWG	22-6	
General data			
Type of insulation material		Wemid (PA)	
UL 94 flammability rating		V-0	
Contact base material		E-Cu	
Material of contact surface		tinned	
Pin dimensions = d	mm	1.2 x 1.2	
Solder eyelet Ø = D	mm	1.6	
Solder eyelet Ø tolerance	mm	+ 0,1	

Product data

IEC: 1000 V / 76 A / 0.5 - 16 mm²
 UL: 300 V / 65 A / AWG 26 - 6

For additional articles and information, refer to catalog.weidmueller.com

Note:

- Additional colours on request
- Rated current related to rated cross-section & min. No. of poles.
- Wire end ferrule without plastic collar to DIN 46228/1
- Wire end ferrule with plastic collar to DIN 46228/4
- P on drawing = pitch
- Rated data refer only to the component itself. Clearance and creepage distances to other components are to be designed in accordance with the relevant application standards.

LU 10.16/./90



Dimensioned drawing

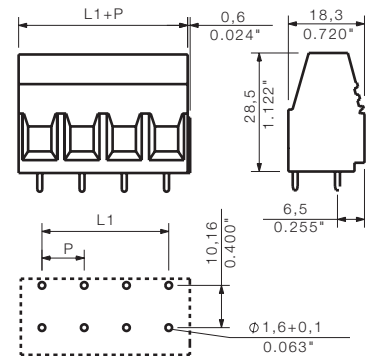

Ordering data

Solder pin length		4.5 mm	
Colour		Black	
Pitch 10.16 mm			
Pol.	L1	(inch)	Qty. Order No.
2	10.16	0.400	20 1934140000
3	20.32	0.800	20 1921450000
4	30.48	1.200	20 1226220000
5	40.64	1.600	20 1226230000
6	50.80	2.000	20 1226240000
7	60.96	2.400	20 1226250000
8	71.12	2.800	20 1226260000
9	81.28	3.200	20 1226270000
10	91.44	3.600	20 1226280000

Accessories

Note: Refer to the Accessories chapter for additional accessories.

Screwdriver	Order No.
SDIS 1.0X5.5X125	9008410000
SDS 1.0X5.5X150	9008350000

Representative deratings curve

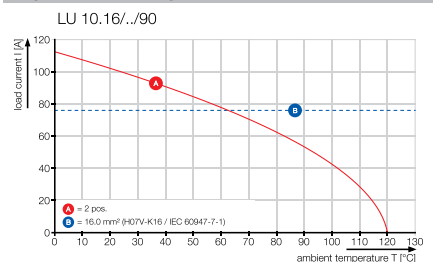

LUP 10.16/./90

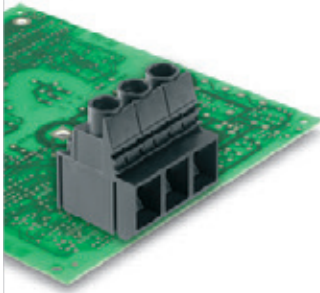

High-power PCB Terminal with clamping yoke screw connection, in 10.16 mm pitch for wire cross-sections up to 16 mm² (AWG 6).

- Increased derating reserves because WEMID insulating material is used.
- Wire outlet direction: 90°
- With integrated test point for the PS 2.0 test plug.

Technical data

In compliance with IEC 60664-1 / IEC 61984

Clamping range, max.	mm ²	0.13...16	
Solid core H05(07) V-U	mm²	0.5...16	
Stranded H07 V-R		6...16	
Flexible H05(07) V-K	mm ²	0.5...16	
Flexible with ferrule	mm ²	2.5...10	
Ferrule with plastic collar	mm ²	2.5...10	
Stripping length	mm	12	
Screwdriver blade	mm	1.0 x 5.5	
		According to norm	
Tightening torque range	Nm	1.2...1.5	
Rated current, max.	A	76	72
At ambient temperature		20°C	40°C
For conductor cross-section	mm ²	16	
Overvoltage category		III	II
Pollution severity		3	2
Rated voltage	V	800	1000
Rated impulse voltage	kV	8	6
UL / CUL (Use Group)		B	C D
Rated voltage	V	300	300
Rated current	A	58	10
AWG conductor	AWG	26-6	
CSA (Use Group)		B	C D
Rated voltage	V	300	300
Rated current	A	58	10
AWG conductor	AWG	22-6	
General data			
Type of insulation material		Wemid (PA)	
UL 94 flammability rating		V-0	
Contact base material		E-Cu	
Material of contact surface		tinned	
Pin dimensions = d	mm	1.2 x 1.2	
Solder eyelet Ø = D	mm	1.6	
Solder eyelet Ø tolerance	mm	+ 0,1	

Product data

IEC: 1000 V / 76 A / 0.5 - 16 mm²
UL: 300 V / 58 A / AWG 26 - 6





For additional articles and information, refer to catalog.weidmueller.com

Note:

- Additional colours on request
- Rated current related to rated cross-section & min. No. of poles.
- Wire end ferrule without plastic collar to DIN 46228/1
- Wire end ferrule with plastic collar to DIN 46228/4
- P on drawing = pitch
- Rated data refer only to the component itself. Clearance and creepage distances to other components are to be designed in accordance with the relevant application standards.

Accessories

Note: Refer to the Accessories chapter for additional accessories.

Screwdriver		Order No.
	SDIS 1.0X5.5X125	9008410000
	SDS 1.0X5.5X150	9008350000
Crosshead screwdriver		
	SDIK PZ2	9008890000
	SDK PZ2	9008540000
Test plug		
	PS 2.0 MC	0310000000

LUP 10.16/./90

with test point



Dimensioned drawing

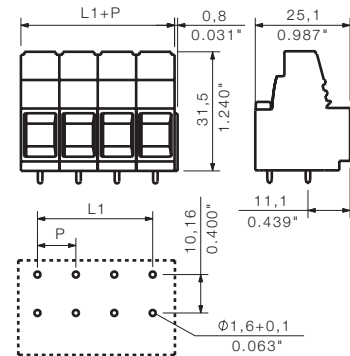

Ordering data

Solder pin length		3.2 mm		
Colour		Black		
Pitch		10.16 mm		
Pol.	L1	(inch)	Qty.	Order No.
2	10.16	0.400	20	1226290000
3	20.32	0.800	20	1226300000
4	30.48	1.200	20	1226310000
5	40.64	1.600	20	1226320000
6	50.80	2.000	20	1226330000
7	60.96	2.400	20	1226340000
8	71.12	2.800	20	1226350000
9	81.28	3.200	20	1226360000

Representative deratings curve

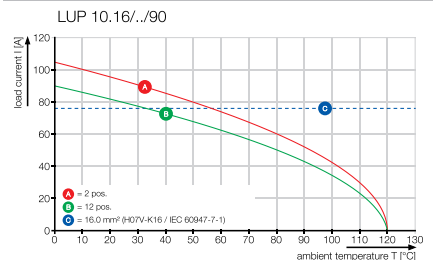

LUP 10.16/./90V

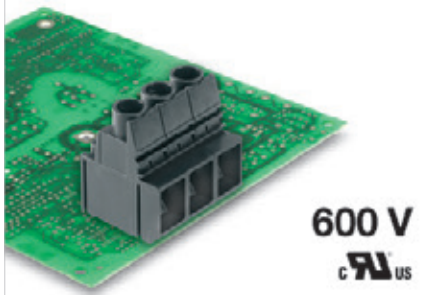

High-power PCB Terminal with clamping yoke screw connection, in 10.16 mm pitch for wire cross-sections up to 16 mm² (AWG 6).

- UL 600 V approval.
- Increased derating reserves because WEMID insulating material is used.
- Wire outlet direction: 90°.
- With integrated test point for PS 2.0 test plug.

Technical data

In compliance with IEC 60664-1 / IEC 61984			
Clamping range, max.	mm ²	0.13...16	
Solid core H05(07) V-U	mm²	0.5...16	
Stranded H07 V-R		6...16	
Flexible H05(07) V-K	mm ²	0.5...16	
Flexible with ferrule	mm ²	2.5...10	
Ferrule with plastic collar	mm ²	2.5...10	
Stripping length	mm	12	
Screwdriver blade	mm	1.0 x 5.5	
		According to norm DIN 5264	
Tightening torque range	Nm	1.2...1.5	
Rated current, max.	A	76	72
At ambient temperature		20°C	40°C
For conductor cross-section	mm ²	16	
Overvoltage category		III	III II
Pollution severity		3	2 2
Rated voltage	V	800	1000 1000
Rated impulse voltage	kV	8	8 6
UL / CUL (Use Group)	B C D	B	C D
Rated voltage	V	600	600 600
Rated current	A	51	51 5
AWG conductor	AWG	22-6	
CSA (Use Group)	B C D	B	C D
Rated voltage	V	600	600 600
Rated current	A	51	51 5
AWG conductor	AWG	22-6	
General data			
Type of insulation material		Wemid (PA)	
UL 94 flammability rating		V-0	
Contact base material		E-Cu	
Material of contact surface		tinned	
Pin dimensions = d	mm	1.2 x 1.2	
Solder eyelet Ø = D	mm	1.6	
Solder eyelet Ø tolerance	mm	+ 0,1	

Product data

IEC: 1000 V / 76 A / 0.5 - 16 mm²
UL: 600 V / 51 A / AWG 22 - 6

For additional articles and information, refer to catalog.weidmueller.com

Note:

- Additional colours on request
- Rated current related to rated cross-section & min. No. of poles.
- Wire end ferrule without plastic collar to DIN 46228/1
- Wire end ferrule with plastic collar to DIN 46228/4
- P on drawing = pitch
- Rated data refer only to the component itself. Clearance and creepage distances to other components are to be designed in accordance with the relevant application standards.

LUP 10.16/./90V

with test point



Dimensioned drawing

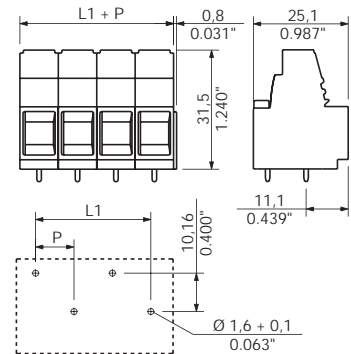

Accessories

Note: Refer to the Accessories chapter for additional accessories.

Screwdriver		Order No.
	SDIS 1.0X5.5X125	9008410000
	SDS 1.0X5.5X150	9008350000
Crosshead screwdriver		
	SDIK PZ2	9008890000
	SDK PZ2	9008540000
Test plug		
	PS 2.0 MC	0310000000

Ordering data

Solder pin length		3.2 mm		
Colour		Black		
Pitch		10.16 mm		
Pol.	L1	(inch)	Qty.	Order No.
2	10.16	0.400	20	1192980000
3	20.32	0.800	20	1192990000
4	30.48	1.200	20	1193000000
5	40.64	1.600	20	1193010000
6	50.80	2.000	20	1193020000
7	60.96	2.400	20	1193030000
8	71.12	2.800	20	1193040000
9	81.28	3.200	20	1193050000

Representative deratings curve

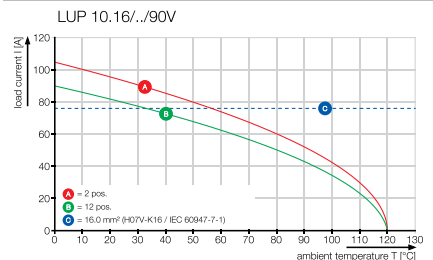

LUP 12.7../90

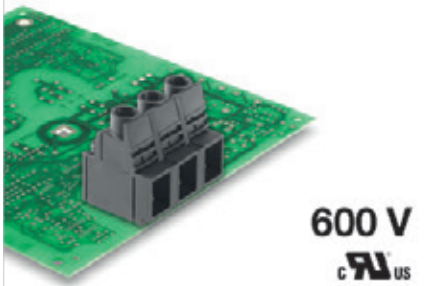

600 V

High-power PCB Terminal with clamping yoke screw connection, in 12.70 mm pitch for wire cross-sections up to 16 mm².

- UL 600 V approval.
- Increased derating reserves because WEMID insulating material is used.
- Wire outlet direction: 90°.
- With integrated test point for PS 2.0 test plug.

Technical data

In compliance with IEC 60664-1 / IEC 61984

Clamping range, max.	mm ²	0.13...16
Solid core H05(07) V-U	mm²	0.5...16
Stranded H07 V-R		6...16
Flexible H05(07) V-K	mm ²	0.5...16
Flexible with ferrule	mm ²	2.5...10
Ferrule with plastic collar	mm ²	2.5...10
Stripping length	mm	12
Screwdriver blade	mm	1.0 x 5.5
According to norm		DIN 5264
Tightening torque range	Nm	1.2...1.5
Rated current, max.	A	76 76
At ambient temperature		20°C 40°C
For conductor cross-section	mm ²	16
Overvoltage category		III III II
Pollution severity		3 2 2
Rated voltage	V	1000 1000 1000
Rated impulse voltage	kV	8 8 6
UL / CUL (Use Group)	B C D	
Rated voltage	V	600 600 600
Rated current	A	58 58 5
AWG conductor	AWG	26-6
CSA (Use Group)	B C D	
Rated voltage	V	600 600 600
Rated current	A	58 58 5
AWG conductor	AWG	22-6
General data		
Type of insulation material		Wemid (PA)
UL 94 flammability rating		V-0
Contact base material		E-Cu
Material of contact surface		tinned
Pin dimensions = d	mm	1.2 x 1.2
Solder eyelet Ø = D	mm	1.6
Solder eyelet Ø tolerance	mm	+ 0,1

Product data

IEC: 1000 V / 76 A / 0.5 - 16 mm²
 UL: 600 V / 58 A / AWG 26 - 6

For additional articles and information, refer to catalog.weidmueller.com

Note:

- Additional colours on request
- Rated current related to rated cross-section & min. No. of poles.
- Wire end ferrule without plastic collar to DIN 46228/1
- Wire end ferrule with plastic collar to DIN 46228/4
- P on drawing = pitch
- Rated data refer only to the component itself. Clearance and creepage distances to other components are to be designed in accordance with the relevant application standards.

Accessories

Note: Refer to the Accessories chapter for additional accessories.

Screwdriver		Order No.
	SDIS 1.0X5.5X125	9008410000
	SDS 1.0X5.5X150	9008350000
Crosshead screwdriver		
	SDIK PZ2	9008890000
	SDK PZ2	9008540000
Test plug		
	PS 2.0 MC	0310000000

LUP 12.7../90

with test point



Dimensioned drawing

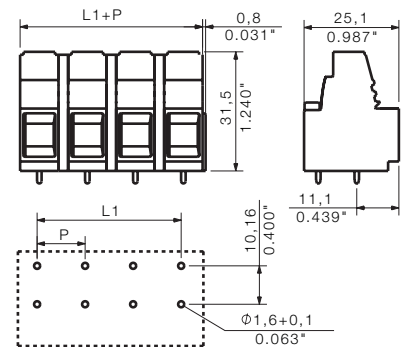

Ordering data

Solder pin length		3.2 mm		
Colour		Black		
Pitch 12.70 mm				
Pol.	L1	(inch)	Qty.	Order No.
2	12.70	0.500	20	1226370000
3	25.40	1.000	20	1226380000
4	38.10	1.500	20	1226390000
5	50.80	2.000	20	1226410000
6	63.50	2.500	20	1226420000
7	76.20	3.000	20	1226430000
8	88.90	3.250	20	1226440000
9	101.60	4.000	20	1226450000

Representative deratings curve

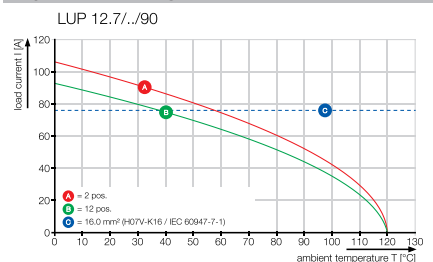

LX 15.00/./90

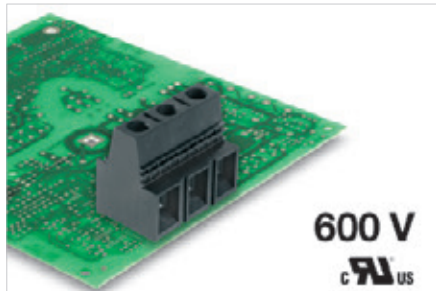

High-power PCB Terminal with clamping yoke screw connection, in 15.00 mm pitch for wire cross-sections up to 25 mm² (AWG 4).

- UL 600 V approval.
- Increased derating reserves because WEMID insulating material is used.
- Wire outlet direction: 90°.
- With integrated test point for PS 2.0 test plug.
- Versions up to 8 poles have block construction.
- Available with and without mounting flange.

Technical data

In compliance with IEC 60664-1 / IEC 61984			
Clamping range, max.	mm ²	1.31...25	
Solid core H05(07) V-U	mm²	1.5...16	
Stranded H07 V-R		6...25	
Flexible H05(07) V-K	mm ²	1.5...25	
Flexible with ferrule	mm ²	1.5...16	
Ferrule with plastic collar	mm ²	1.5...16	
Stripping length	mm	16	
Screwdriver blade	mm	1.0 x 5.5	
		According to norm DIN 5264	
Tightening torque range	Nm	2.4...4	
Rated current, max.	A	101	101
At ambient temperature		20°C	40°C
For conductor cross-section	mm ²	25	
Overvoltage category		III	III II
Pollution severity		3	2 2
Rated voltage	V	1000	1000 1000
Rated impulse voltage	kV	8	8 6
UL / CUL (Use Group)		B	C D
Rated voltage	V	600	600 600
Rated current	A	85	85 5
AWG conductor	AWG	16-4	
CSA (Use Group)		B	C D
Rated voltage	V	600	600 600
Rated current	A	85	85 5
AWG conductor	AWG	16-4	
General data			
Type of insulation material		Wemid (PA)	
UL 94 flammability rating		V-0	
Contact base material		E-Cu	
Material of contact surface		tinned	
Pin dimensions = d	mm	1.2 x 1.2	
Solder eyelet Ø = D	mm	1.6	
Solder eyelet Ø tolerance	mm	+ 0,1	

Product data

IEC: 1000 V / 101 A / 1.5 - 25 mm²
 UL: 600 V / 85 A / AWG 16 - 4

For additional articles and information, refer to catalog.weidmueller.com

Note:

- Additional colours on request
- Rated current related to rated cross-section & min. No. of poles.
- Wire end ferrule without plastic collar to DIN 46228/1
- Wire end ferrule with plastic collar to DIN 46228/4
- P on drawing = pitch
- Rated data refer only to the component itself. Clearance and creepage distances to other components are to be designed in accordance with the relevant application standards.

LX 15.00/./90

with test point



Dimensioned drawing

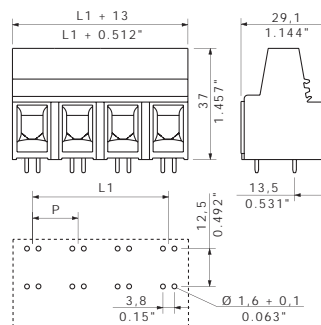

Accessories

Note: Refer to the Accessories chapter for additional accessories.

Screwdriver		Order No.
	SDIS 1.2X6.5X150	9008420000
	SDS 1.2X6.5X150	9009010000
Crosshead screwdriver		
	SDIK PZ2	9008890000
	SDK PZ2	9008540000
Test plug		
	PS 2.0 MC	0310000000

Ordering data

Solder pin length		4.5 mm		
Colour		Black		
Pitch 15.00 mm				
Pol.	L1	(inch)	Qty.	Order No.
1	0.00	0.000	20	1226460000
2	15.00	0.591	20	1226470000
3	30.00	1.181	20	1174720000
4	45.00	1.772	20	1226480000
5	60.00	2.362	20	1226490000
6	75.00	2.953	10	1226500000
7	90.00	3.543	10	1226510000
8	105.00	4.134	10	1921480000

Representative deratings curve

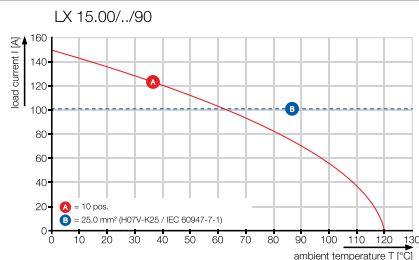

LXB 15.00/./90

with fixing flange and test point



Dimensioned drawing

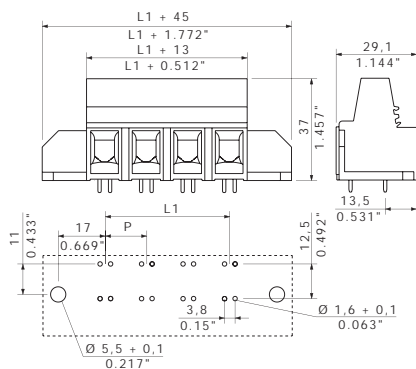

Ordering data

Solder pin length		4.5 mm		
Colour		Black		
Pitch		15.00 mm		
Pol.	L1	(inch)	Qty.	Order No.
2	15.00	0.591	20	1226520000
3	30.00	1.181	20	1226530000
4	45.00	1.772	20	1226540000
5	60.00	2.362	20	1226550000
6	75.00	2.953	10	1226560000
7	90.00	3.543	10	1226570000
8	105.00	4.134	10	1226580000

LXBL 15.00/./90

with fixing flange left and test point



Dimensioned drawing

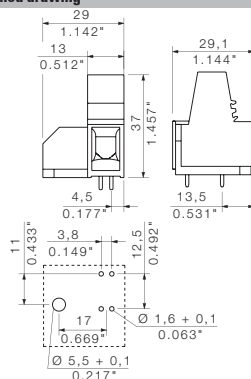

Ordering data

Solder pin length		4.5 mm		
Colour		Black		
Pitch		15.00 mm		
Pol.	L1	(inch)	Qty.	Order No.
1	0.00	0.000	20	1226590000

Additional deratings curves

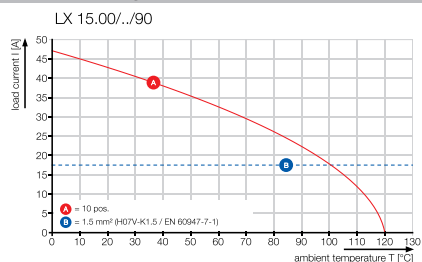

LXXX 15.00/./90

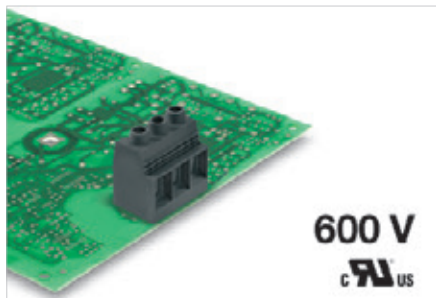

High-power PCB Terminal with clamping yoke screw connection, in 15.00 mm pitch for wire cross-sections up to 50 mm² (AWG 1).

- UL 600 V approval for unlimited international usage in devices.
- Increased derating reserves because WEMID insulating material is used.
- Wire outlet direction of 90°.
- With integrated test point for PS 2.0 test plug.
- Versions up to 8 poles have block construction.
- Available with and without mounting flange.

Technical data

In compliance with IEC 60664-1 / IEC 61984			
Clamping range, max.	mm ²	0.5...50	
Solid core H05(07) V-U	mm²	0.5...16	
Stranded H07 V-R		6...50	
Flexible H05(07) V-K	mm ²	0.5...35	
Flexible with ferrule	mm ²	0.5...35	
Ferrule with plastic collar	mm ²	0.5...35	
Stripping length	mm	18	
Screwdriver blade	mm	1.2 x 6.5	
According to norm		DIN 5264	
Tightening torque range	Nm	2.5...4	
Rated current, max.	A	150	150
At ambient temperature		20°C	40°C
For conductor cross-section	mm ²	35	
Overvoltage category		III	III II
Pollution severity		3	2 2
Rated voltage	V	1000	1000 1000
Rated impulse voltage	kV	8	8 8
UL / CUL (Use Group)		B	C D
Rated voltage	V	600	600 600
Rated current	A	127	127 5
AWG conductor	AWG	20-1	
CSA (Use Group)		B	C D
Rated voltage	V	600	600 600
Rated current	A	127	127 5
AWG conductor	AWG	20-1	
General data			
Type of insulation material		Wemid (PA)	
UL 94 flammability rating		V-0	
Contact base material		Copper alloy	
Material of contact surface		tinned	
Pin dimensions = d	mm	1.2 x 1.2	
Solder eyelet Ø = D	mm	1.6	
Solder eyelet Ø tolerance	mm	+ 0,1	

Product data

IEC: 1000 V / 150 A / 0.5 - 50 mm²
 UL: 600 V / 127 A / AWG 20 - 1

For additional articles and information, refer to catalog.weidmueller.com

Note:

- Additional colours on request
- Rated current related to rated cross-section & min. No. of poles.
- Wire end ferrule without plastic collar to DIN 46228/1
- Wire end ferrule with plastic collar to DIN 46228/4
- P on drawing = pitch
- Rated data refer only to the component itself. Clearance and creepage distances to other components are to be designed in accordance with the relevant application standards.
- IP 20 from 16 mm² to 50 mm²

LXXX 15.00/./90

with test point



Dimensioned drawing

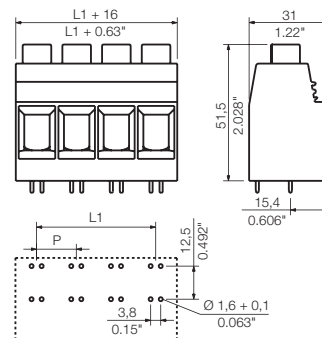

Ordering data

Solder pin length		4.5 mm		
Colour		Black		
Pitch		15.00 mm		
Pol.	L1	(inch)	Qty.	Order No.
1	0.00	0.000	20	1047120000
2	15.00	0.591	20	1047130000
3	30.00	1.181	10	1047140000
4	45.00	1.772	10	1047150000

Accessories

Note: Refer to the Accessories chapter for additional accessories.

Screwdriver		Order No.
	SDIS 1.2X6.5X150	9008420000
	SDS 1.2X6.5X150	9009010000
Crosshead screwdriver		
	SDIK PZ2	9008890000
	SDK PZ2	9008540000
Test plug		
	PS 2.0 MC	0310000000

Representative deratings curve

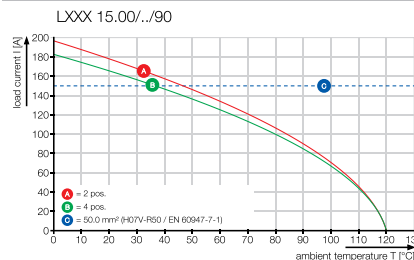

LXXX 15.00/./90F

with fixing flange and test point



Dimensioned drawing

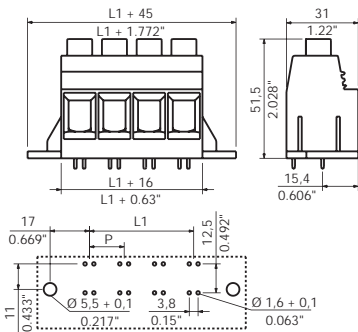

Ordering data

Solder pin length		4.5 mm			
Colour		Black			
Pitch		15.00 mm			
Pol.	L1	(inch)	Qty.	Order No.	
1	0.00	0.000	20	1047280000	
2	15.00	0.591	20	1047290000	
3	30.00	1.181	10	1047300000	
4	45.00	1.772	10	1047310000	

LXXX 15.00/./90FL

with fixing flange left and test point



Dimensioned drawing

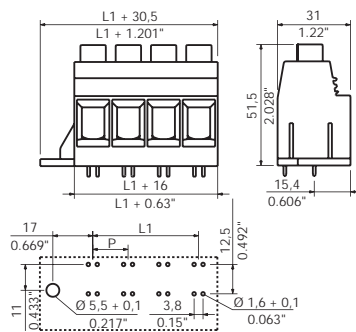

Ordering data

Solder pin length		4.5 mm			
Colour		Black			
Pitch		15.00 mm			
Pol.	L1	(inch)	Qty.	Order No.	
1	0.00	0.000	20	1047440000	
2	15.00	0.591	20	1047450000	
3	30.00	1.181	10	1047460000	
4	45.00	1.772	10	1047470000	

LXXX 15.00/./90FR

with fixing flange right and test point



Dimensioned drawing

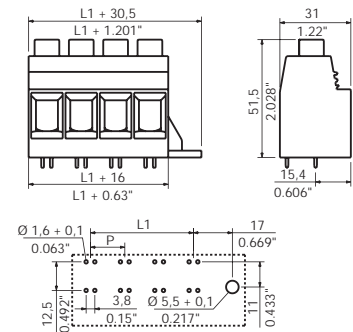

Ordering data

Solder pin length		4.5 mm			
Colour		Black			
Pitch		15.00 mm			
Pol.	L1	(inch)	Qty.	Order No.	
1	0.00	0.000	20	1047600000	
2	15.00	0.591	20	1047610000	
3	30.00	1.181	10	1047620000	
4	45.00	1.772	10	1047630000	

Additional deratings curves

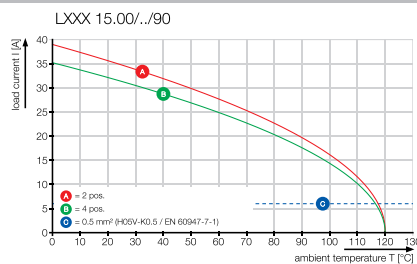
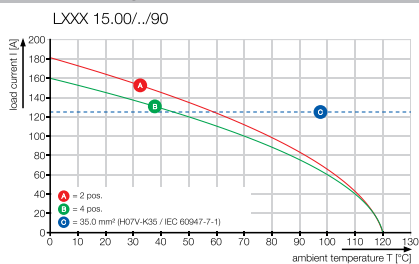

OMNIMATE Power PCB connectors

**OMNIMATE Power
PCB connectors**

OMNIMATE Power		F.2
	Explanation	F.2
OMNIMATE Power HP to 4 mm ²		
	Explanation	F.4
	Quick selection	F.6
	Technical data	F.8
OMNIMATE Power HP 6 mm ²		
	Explanation	F.24
	Quick selection	F.26
	Technical data	F.28
OMNIMATE Power HP 16 mm ²		
	Explanation	F.76
	Quick selection	F.78
	Technical data	F.80
OMNIMATE Power IT		
	Explanation	F.92
	Quick selection	F.94
	Technical data	F.96
OMNIMATE Power Hybrid		
	Explanation	F.112
	Quick selection	F.114
	Technical data	F.116

OMNIMATE Power on BOARD

Integrated connection systems delivering innovative drive applications

The OMNIMATE Power system excels in power electronics and drive applications because it has implemented and incorporated customer and market requirements.

Custom-fit connection solutions for power electronics – resulting from the synergy between application-oriented components, individual services and competent design-in support.

The following pages show why OMNIMATE Power is the ideal system for power electronics and drive applications. This system has benefited from our broader perspective of component directives and our consistent implementation of requests from the market and customers.

Performance + Innovation

Designed with future requirements in mind whether for cars or servo-drives: hybrid design concepts create an efficient solution from two distinct elements.

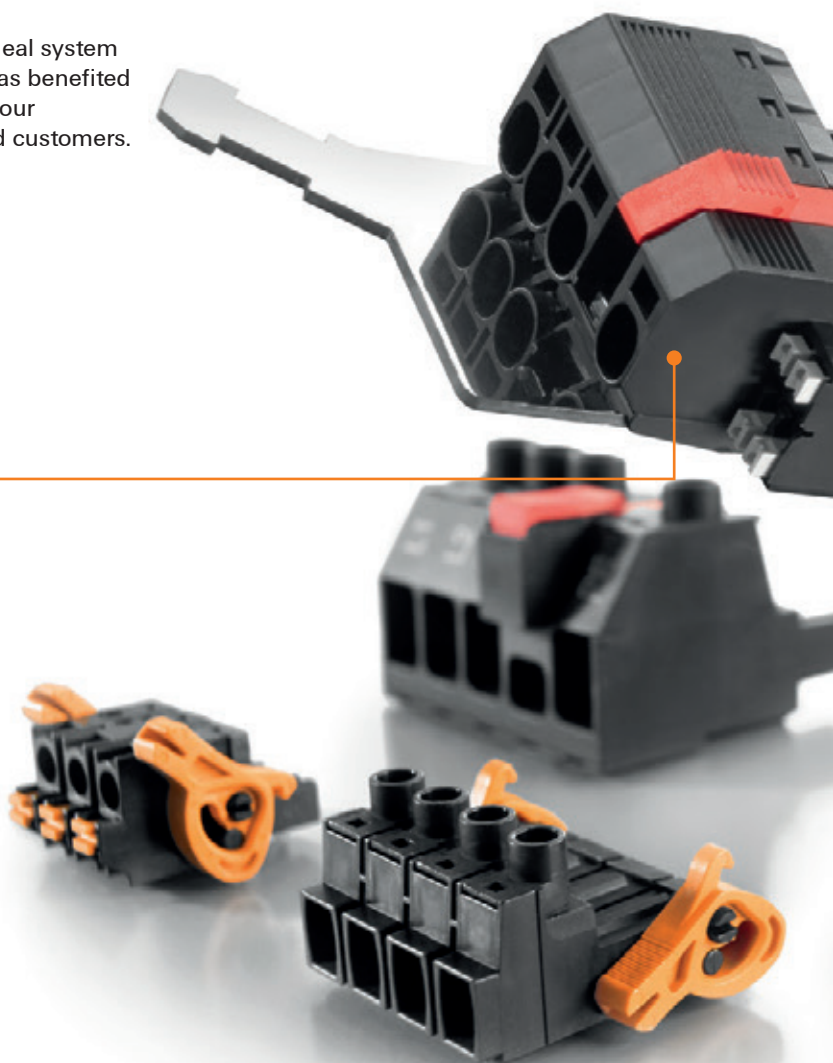
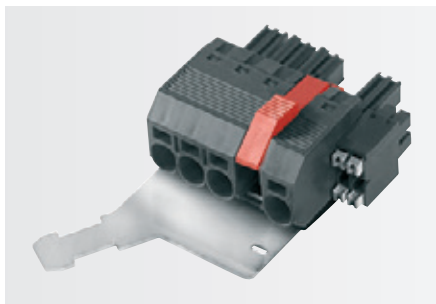

Performance + Support

Weidmüller delivers more than just components. Our design-in competence encompassing work from design and implementation to the market release phase delivers the top results.

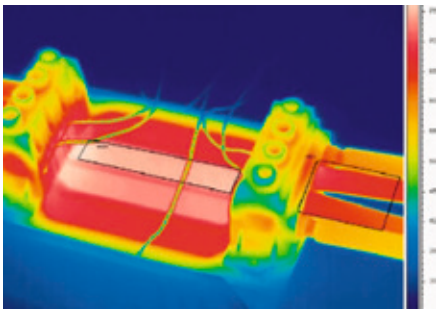

Performance + Services

Customised services supplement our comprehensive standard portfolio. The housing colour, printing, coding, contact surfaces, packaging and much more can be configured online with just a few mouse clicks.

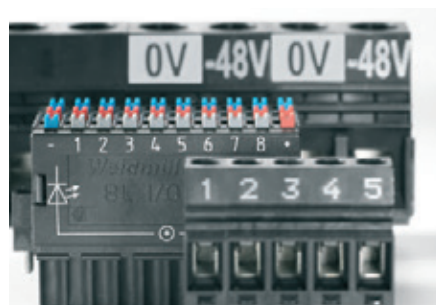

Weidmüller's connection strategy for drive applications joins power and signals. It also takes advantage of innovative EMC protection for data transmissions between the communications modules.

Power – Signal – Data

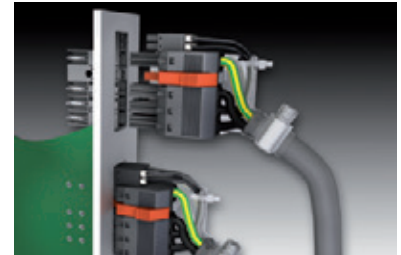

An overview of OMNIMATE Power

The single-source solution that omits no necessary components a result of Weidmüller's technology and application expertise delivers the optimal designed-in results. The following pages describe the individual product lines in detail.



Design-In Services & Support

The path to top results starts before component selection and does not end with delivery. More information can be found in the "Services & Support" brochure (order number 1077670000) or at <http://galaxy.weidmueller.com>



OMNIMATE Power BL/SL 7.62HP – the 12 kVA power class

Custom-fit solutions for compact devices

Compact power for more safety and efficiency: The compact class in the OMNIMATE Power BL/SL 7.62HP power connector series integrates previously-conflicting market requirements to provide a custom-fit solution for drive applications.

This closes the gap between increasing miniaturisation and unlimited 600 V UL approval. The system extension to the 12 kVA power class enables a touch-safe, inverted motor connection with one-handed safety interlock. The PUSH IN connection system also provides a quick and reliable wire connection. Doublesided touch protection guarantees full protection even with inverse voltages. Thus even OMNIMATE Power's compact class is qualified for use with the DC link bus.

Compact safety

No additional measures required for DC links or inverse voltage: the inverted versions have finger-safe male header and female header even when not plugged in.



Compact reliability

Maintenance-free and vibration-proof connections: quick and simple PUSH IN connections, or the self-fastening Weidmüller steel clamp with plus/minus screw and WIRE GUARD.

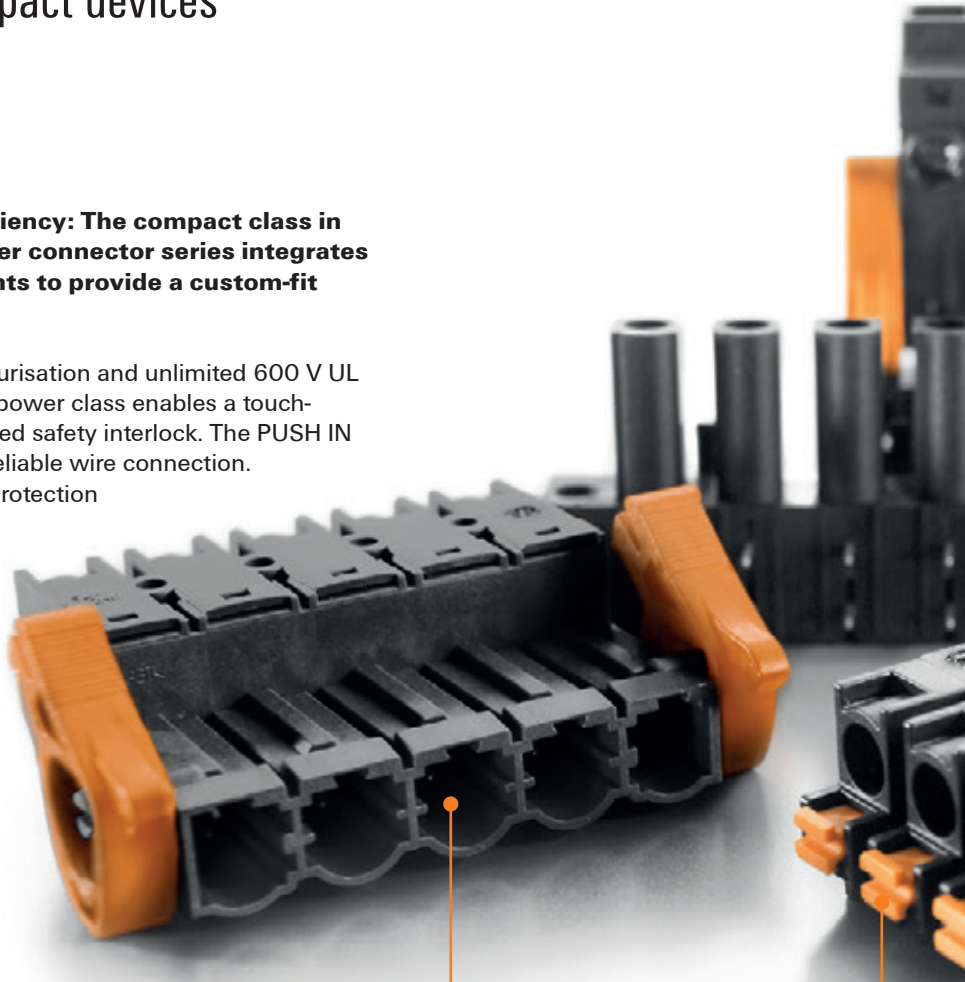

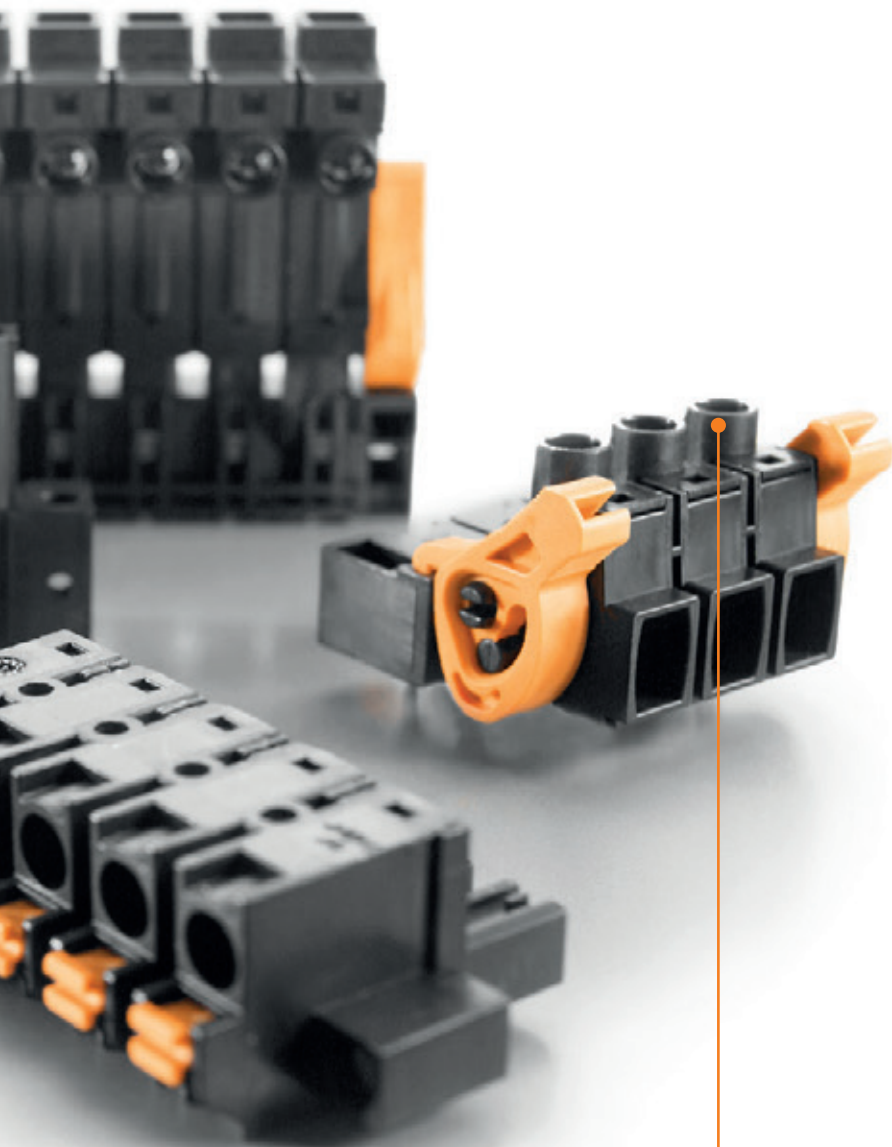

Compact integration

No compromises during design and approval: compact and standard-compliant with additional +3.0 mm finger safety, according to IEC 61800-5-1, and increased creepage and clearance distances according to UL.

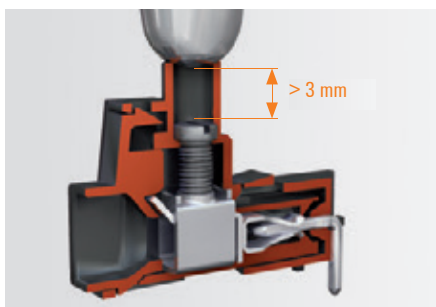

Compact system power

An overview of OMNIMATE Power's 12 kVA class: The compact system with either standard or inverted mating profile, with screw or PUSH IN wire connection; optionally with lock & release lever, screw flange or one-handed safety interlock.

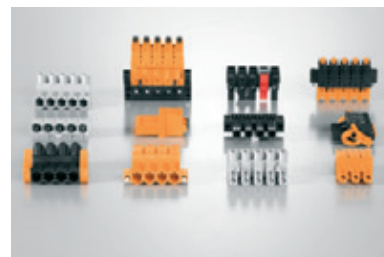

Unrivalled current-carrying capacity

The highest load capacity in the 12 kVA compact class: with up to 29 A current-carrying capacity at 1.000 V (IEC) with a 4 mm² wire cross-section or 18.5 A at 600 V according to UL.







Individualised configuration

Standard + Services = custom design with simple configuration across the entire range of services: features include colour coding, application-oriented labelling and custom modifications or design. More information can be found in the "Services & Support" brochure (order number 1077670000) or at <http://galaxy.weidmueller.com>



<http://www.OMNIMATE.net>

-  = Wire-to-Board
-  = Board-to-Board
-  = Wire-to-Wire
-  = Board-to-Wire

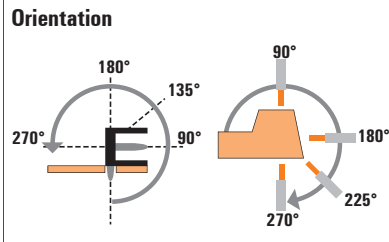

Male header











Solder connection



BL/SL 7.62 series





Type	SL	SL
Orientation	90°	180°
Flange options	G/F/LF	G/F/LF
Product code numbers	IEC: 800 V/24 A UL: 300 V/20 A	IEC: 800 V/24 A UL: 300 V/20 A
Page	F.8	F.10

Female plug		Female header					
 Screw Clamping yoke		BLZ	180° (G)/LR	IEC: 630 V/24 A/0.08 - 4 mm ² UL: 600 V/20 A/AWG 20 - 12	F.16		
	 Spring PUSH IN		BLF	180° (G)/F/LR	IEC: 1.000 V/24 A/0.08 - 4 mm ² UL: 300 V/20 A/AWG 20	F.18	
 Solder connection		BLL	90° (G)/F/LF	IEC: 630 V/24 A UL: 300 V/20 A	F.20		
		BLL	180° (G)/F/LF	IEC: 630 V/24 A UL: 300 V/20 A	F.22		

Female plug and header:
(G) = Closed (without flange)
F = Screw flange with screw
LR = Lock & Release lever

Male header and plug:
G = Closed (without flange)
F = Screw flange with nut
LF = Solder flange with nut
LR = Lock & Release lever

Male plug	
	
Screw Clamping yoke	Spring PUSH IN



	SLZ	SLF
	180°	180°
	G/F/LR	G/F/LR
	IEC: 1.000 V/24 A/ 0.08 - 2.5 mm ² UL: 600 V/17 A/ AWG 20 - 12	IEC: 1.000 V/24 A/ 0.08 - 2.5 mm ² UL: 600 V/20 A/ AWG 20 - 12
	F.12	F.14
	●	●
	●	●

F

Connectors in 7.62 mm pitch
Series BL/SL 7.62 – connects up to 4 mm²

SL 7.62HP/./90

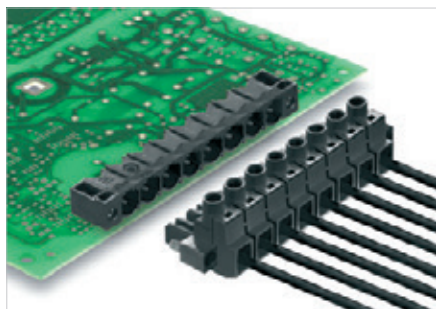

Male header in 90° outlet direction. The compact and efficient solution for UL-600 V applications in the lower power range meets in conjunction with a female plug, the 600 V requirements for UL508 / UL840 and the increased need for touch-safe protection according to IEC 68100-5-1.

- Available with screw flange (F) and a solder flange (SF).

Product data

IEC: 630 V / 29 A
 UL: 300 V / 20 A

For additional articles and information, refer to catalog.weidmueller.com

Note:

- Additional colours on request
- Gold-plated contact surfaces on request
- Rated current related to rated cross-section & min. No. of poles.
- P on drawing = pitch
- Rated data refer only to the component itself. Clearance and creepage distances to other components are to be designed in accordance with the relevant application standards.

SL 7.62HP/./90G



Dimensioned drawing

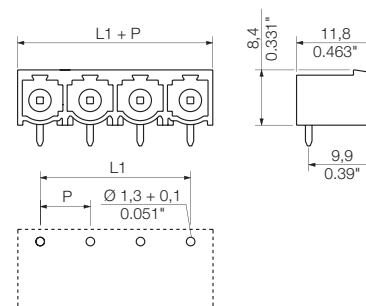



Technical data

In compliance with IEC 60664-1 / IEC 61984			
Clamping range, max.	mm ²		
Solid core H05(07) V-U	mm²		
Stranded H07 V-R			
Flexible H05(07) V-K	mm ²		
Flexible with ferrule	mm ²		
Ferrule with plastic collar	mm ²		
Stripping length	mm		
Screwdriver blade	mm		
According to norm			
Tightening torque range	Nm		
Rated current, max.	A	29	25
At ambient temperature		20°C	40°C
For conductor cross-section	mm ²		
Overtoltage category		III	III II
Pollution severity		3	2 2
Rated voltage	V	400	500 630
Rated impulse voltage	kV	6	6 6
UL / CUL (Use Group)		B	C D
Rated voltage	V	300	300 600
Rated current	A	20	20 5
AWG conductor	AWG		-
CSA (Use Group)		B	C D
Rated voltage	V	300	300 600
Rated current	A	20	20 5
AWG conductor	AWG		-
General data			
Type of insulation material		PBT	
UL 94 flammability rating		V-0	
Contact base material		Copper alloy	
Material of contact surface		tinned	
Pin dimensions = d	mm	1.0 x 1.0	
Solder eyelet Ø = D	mm	1.3	
Solder eyelet Ø tolerance	mm	+ 0,1	

Accessories

Note: Refer to the Accessories chapter for additional accessories.

Coding	Order No.
 BLZ/SL KO OR	1573010000
 BLZ/SL KO SW	1545710000

Ordering data

Solder pin length		3.2 mm		
Colour		Black		
Pitch		7.62 mm		
Pol.	L1	(inch)	Qty.	Order No.
2	7.62	0.300	100	1026760000
3	15.24	0.600	100	1026770000
4	22.86	0.900	100	1026780000
5	30.48	1.200	50	1026790000
6	38.10	1.500	50	1059490000
7	45.72	1.800	50	1059500000
8	53.34	2.100	50	1059510000
9	60.96	2.400	50	1059520000
10	68.58	2.700	50	1059530000
11	76.20	3.000	50	1059550000
12	83.82	3.300	50	1059570000

SL 7.62HP/./90F



SL 7.62HP/./90LF



Dimensioned drawing

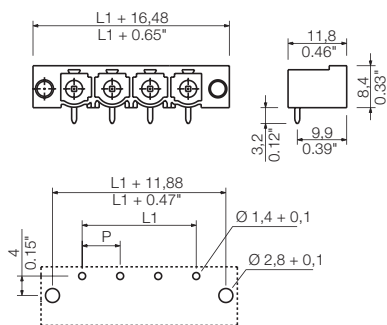

Dimensioned drawing

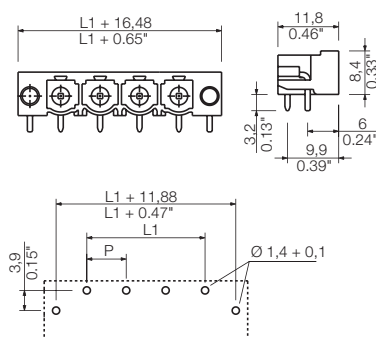

Ordering data

Solder pin length		3.2 mm			
Colour		Black			
Pitch		7.62 mm			
Pol.	L1	(inch)	Qty.	Order No.	
2	7.62	0.300	100	1026850000	
3	15.24	0.600	100	1026860000	
4	22.86	0.900	100	1026870000	
5	30.48	1.200	50	1026880000	
6	38.10	1.500	50	1124250000	
7	45.72	1.800	50	1124270000	
8	53.34	2.100	50	1124280000	
9	60.96	2.400	50	1124290000	
10	68.58	2.700	50	1124300000	
11	76.20	3.000	50	1124310000	
12	83.82	3.300	50	1124320000	

Ordering data

Solder pin length		3.2 mm			
Colour		Black			
Pitch		7.62 mm			
Pol.	L1	(inch)	Qty.	Order No.	
2	7.62	0.300	100	1095920000	
3	15.24	0.600	100	1095930000	
4	22.86	0.900	100	1095940000	
5	30.48	1.200	50	1095950000	
6	38.10	1.500	50	1095960000	
7	45.72	1.800	50	1095970000	
8	53.34	2.100	50	1095980000	
9	60.96	2.400	50	1095990000	
10	68.58	2.700	50	1096000000	
11	76.20	3.000	50	1096010000	
12	83.82	3.300	50	1096020000	

Connectors in 7.62 mm pitch
Series BL/SL 7.62 – connects up to 4 mm²

SL 7.62HP/./180

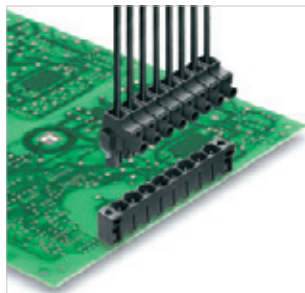

Male header in 180° outlet direction. The compact and efficient solution for UL-600 V applications in the lower power range meets in conjunction with a female plug, the 600 V requirements for UL508 / UL840 and the increased need for touch-safe protection according to IEC 68100-5-1.

- Available with screw flange (F) and a solder flange (SF).

Product data

IEC: 630 V / 26 A
 UL: 300 V / 20 A

For additional articles and information, refer to catalog.weidmuller.com

Note:

- Additional colours on request
- Gold-plated contact surfaces on request
- Rated current related to rated cross-section & min. No. of poles.
- P on drawing = pitch
- Rated data refer only to the component itself. Clearance and creepage distances to other components are to be designed in accordance with the relevant application standards.

SL 7.62HP/./180G



Dimensioned drawing

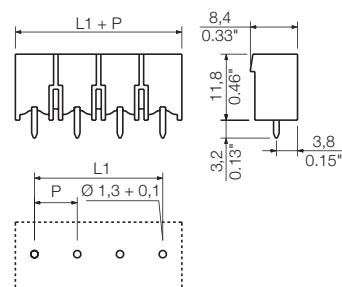

Technical data

In compliance with IEC 60664-1 / IEC 61984			
Clamping range, max.	mm ²		
Solid core H05(07) V-U	mm²		
Stranded H07 V-R			
Flexible H05(07) V-K	mm ²		
Flexible with ferrule	mm ²		
Ferrule with plastic collar	mm ²		
Stripping length	mm		
Screwdriver blade	mm		
According to norm			
Tightening torque range	Nm		
Rated current, max.	A	26	25
At ambient temperature		20°C	40°C
For conductor cross-section	mm ²		
Overtoltage category		III	III II
Pollution severity		3	2 2
Rated voltage	V	400	500 630
Rated impulse voltage	kV	6	6 6
UL / CUL (Use Group)		B	C D
Rated voltage	V	300	300 600
Rated current	A	20	20 5
AWG conductor	AWG		-
CSA (Use Group)		B	C D
Rated voltage	V	300	300 600
Rated current	A	20	20 5
AWG conductor	AWG		-
General data			
Type of insulation material		PBT	
UL 94 flammability rating		V-0	
Contact base material		Copper alloy	
Material of contact surface		tinned	
Pin dimensions = d	mm	1.0 x 1.0	
Solder eyelet Ø = D	mm	1.3	
Solder eyelet Ø tolerance	mm	+ 0,1	

Accessories

Note: Refer to the Accessories chapter for additional accessories.

Coding	Order No.
BLZ/SL KO OR	1573010000
BLZ/SL KO SW	1545710000

Ordering data

Solder pin length		3.2 mm		
Colour		Black		
Pitch		7.62 mm		
Pol.	L1	(inch)	Qty.	Order No.
2	7.62	0.300	100	1122550000
3	15.24	0.600	100	1122570000
4	22.86	0.900	100	1122580000
5	30.48	1.200	50	1048980000
6	38.10	1.500	50	1048990000
7	45.72	1.800	50	1122590000
8	53.34	2.100	50	1049000000
9	60.96	2.400	50	1122600000
10	68.58	2.700	50	1122610000
11	76.20	3.000	50	1122640000
12	83.82	3.300	50	1122650000

SL 7.62HP/./180F



SL 7.62HP/./180LF



Dimensioned drawing

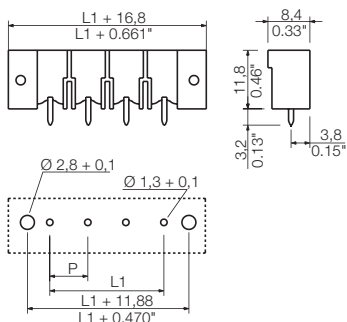

Dimensioned drawing

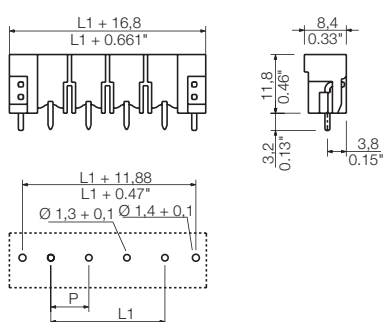

Ordering data

Solder pin length		3.2 mm			
Colour		Black			
Pitch 7.62 mm					
Pol.	L1	(inch)	Qty.	Order No.	
2	7.62	0.300	100	1140870000	
3	15.24	0.600	100	1140880000	
4	22.86	0.900	100	1140890000	
5	30.48	1.200	50	1140900000	
6	38.10	1.500	50	1140910000	
7	45.72	1.800	50	1140920000	
8	53.34	2.100	50	1140930000	
9	60.96	2.400	50	1140940000	
10	68.58	2.700	50	1140950000	
11	76.20	3.000	50	1140960000	
12	83.82	3.300	50	1140970000	

Ordering data

Solder pin length		3.2 mm			
Colour		Black			
Pitch 7.62 mm					
Pol.	L1	(inch)	Qty.	Order No.	
2	7.62	0.300	100	1141090000	
3	15.24	0.600	100	1141100000	
4	22.86	0.900	100	1141110000	
5	30.48	1.200	50	1141120000	
6	38.10	1.500	50	1141130000	
7	45.72	1.800	50	1141140000	
8	53.34	2.100	50	1141150000	
9	60.96	2.400	50	1141160000	
10	68.58	2.700	50	1141170000	
11	76.20	3.000	50	1141180000	
12	83.82	3.300	50	1141190000	

Connectors in 7.62 mm pitch
Series BL/SL 7.62 – connects up to 4 mm²

SLZ 7.62HP/./180

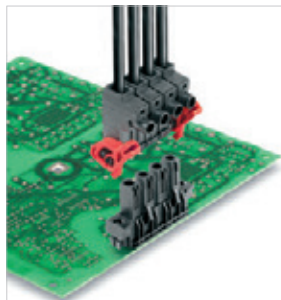

Male plug with clamping-yoke screw connection in 180° outlet direction. Also perfect for finger-safe solutions involving inverse voltages. Complies with UL1059 600 V Use Group C and IEC 61800-5-1 requirements for 3 mm of finger safety on 400 V TNC(S) systems.

- Available with screw flange (F) and lock and release-levers (LR).

Product data

IEC: 1000 V / 20 A / 0.5 - 2.5 mm²
 UL: 600 V / 17 A / AWG 20 - 12

For additional articles and information, refer to catalog.weidmueller.com

Note:

- Additional colours on request
- Gold-plated contact surfaces on request
- Rated current related to rated cross-section & min. No. of poles.
- Wire end ferrule without plastic collar to DIN 46228/1
- Wire end ferrule with plastic collar to DIN 46228/4
- P on drawing = pitch
- Rated data refer only to the component itself. Clearance and creepage distances to other components are to be designed in accordance with the relevant application standards.

SLZ 7.62HP/./180G



Dimensioned drawing

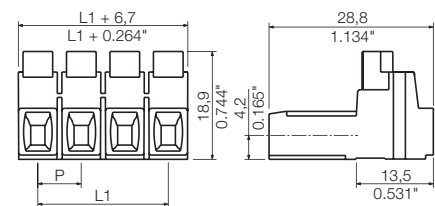

Technical data

In compliance with IEC 60664-1 / IEC 61984

Clamping range, max.	mm ²	0.08...2.5
Solid core H05(07) V-U	mm²	0.5...2.5
Stranded H07 V-R		
Flexible H05(07) V-K	mm ²	0.5...2.5
Flexible with ferrule	mm ²	0.5...2.5
Ferrule with plastic collar	mm ²	0.5...1.5
Stripping length	mm	8
Screwdriver blade	mm	0.6 x 3.5
According to norm		DIN 5264
Tightening torque range	Nm	0.4...0.5

Rated current, max.	A	20	17.5
At ambient temperature		20°C	40°C

For conductor cross-section	mm ²	2.5
Overtoltage category		III III II
Pollution severity		3 2 2

Rated voltage	V	630	1000	1000
Rated impulse voltage	kV	6	8	6

UL / CUL (Use Group)	B	C	D
-----------------------------	----------	----------	----------

Rated voltage	V	600	600	600
----------------------	----------	------------	------------	------------

Rated current	A	17	17	5
----------------------	----------	-----------	-----------	----------

AWG conductor	AWG	20-12
----------------------	------------	--------------

CSA (Use Group)	B	C	D
------------------------	----------	----------	----------

Rated voltage	V	600	600	600
---------------	---	-----	-----	-----

Rated current	A	17	17	5
---------------	---	----	----	---

AWG conductor	AWG	20-12
---------------	-----	-------

General data

Type of insulation material		PBT
UL 94 flammability rating		V-0
Contact base material		Copper alloy
Material of contact surface		tinned
Pin dimensions = d	mm	
Solder eyelet Ø = D	mm	
Solder eyelet Ø tolerance	mm	

Accessories

Note: Refer to the Accessories chapter for additional accessories.

Screwdriver	Order No.
 SDIS 0.6X3.5X100	9008390000
SDS 0.6X3.5X100	9008330000

Ordering data

Solder pin length				
Colour	Black			
Pitch	7.62 mm			
Pol.	L1	(inch)	Qty.	Order No.
2	7.62	0.300	126	1043350000
3	15.24	0.600	84	1043360000
4	22.86	0.900	60	1043370000
5	30.48	1.200	48	1043380000

Representative deratings curve

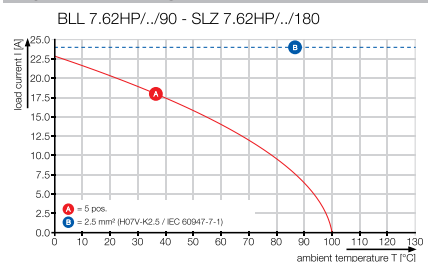

SLZ 7.62HP../180F



Dimensioned drawing

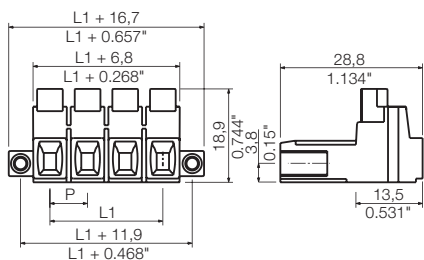

SLZ 7.62HP../180LR



Dimensioned drawing

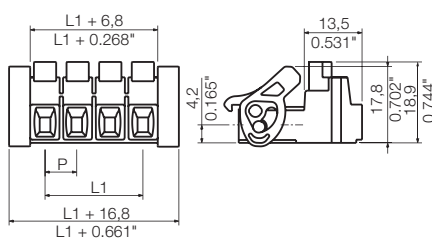

Ordering data

Solder pin length					
Colour					Black
Pitch 7.62 mm					
Pol.	L1	(inch)	Qty.	Order No.	
2	7.62	0.300	72	1043430000	
3	15.24	0.600	54	1043440000	
4	22.86	0.900	42	1043450000	
5	30.48	1.200	36	1043460000	

Ordering data

Solder pin length					
Colour					Black
Pitch 7.62 mm					
Pol.	L1	(inch)	Qty.	Order No.	
2	7.62	0.300	72	1043510000	
3	15.24	0.600	54	1043520000	
4	22.86	0.900	42	1043530000	
5	30.48	1.200	36	1043540000	

Additional deratings curves

BLL 7.62HP../90 - SLZ 7.62HP../180

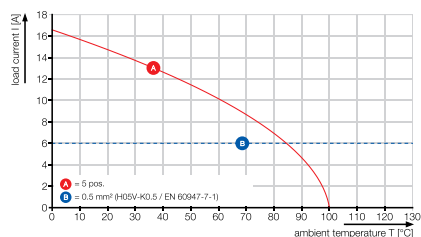

Connectors in 7.62 mm pitch
Series BL/SL 7.62 – connects up to 4 mm²

SLF 7.62HP../180

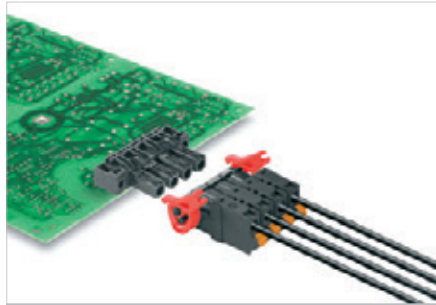

Female plug with PUSH IN spring connection in 180° outlet direction. Also perfect for finger-safe solutions involving inverse voltages. Complies with UL1059 600 V Use Group C and IEC 61800-5-1 requirements for 3 mm of finger safety on 400 V TNC systems.

- Available with screw flange (F) and lock and release-levers (LR).

Product data

IEC: 1000 V / 24 A / 0.5 - 2.5 mm²
 UL: 600 V / 20 A / AWG 20 - 12

For additional articles and information, refer to catalog.weidmueller.com

Note:

- Additional colours on request
- Gold-plated contact surfaces on request
- Rated current related to rated cross-section & min. No. of poles.
- Wire end ferrule without plastic collar to DIN 46228/1
- Wire end ferrule with plastic collar to DIN 46228/4
- P on drawing = pitch
- Rated data refer only to the component itself. Clearance and creepage distances to other components are to be designed in accordance with the relevant application standards.

SLF 7.62HP../180G



Dimensioned drawing

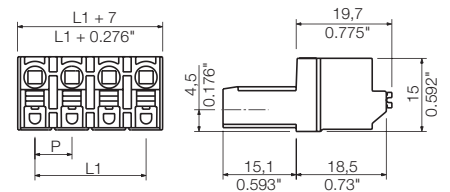

Technical data

In compliance with IEC 60664-1 / IEC 61984		
Clamping range, max.	mm ²	0.08...2.5
Solid core H05(07) V-U	mm²	0.5...2.5
Stranded H07 V-R		
Flexible H05(07) V-K	mm ²	0.5...2.5
Flexible with ferrule	mm ²	0.5...1.5
Ferrule with plastic collar	mm ²	0.5...1.5
Stripping length	mm	10
Screwdriver blade	mm	0.6 x 3.5
According to norm		DIN 5264
Tightening torque range	Nm	
Rated current, max.	A	24 23.8
At ambient temperature	20°C	40°C
For conductor cross-section	mm ²	2.5
Overtoltage category		III III II
Pollution severity		3 2 2
Rated voltage	V	630 1000 1000
Rated impulse voltage	kV	6 8 6
UL / CUL (Use Group)	B C D	
Rated voltage	V	600 600 600
Rated current	A	20 20 5
AWG conductor	AWG	20-12
CSA (Use Group)	B C D	
Rated voltage	V	600 600 600
Rated current	A	20 20 5
AWG conductor	AWG	20-12
General data		
Type of insulation material		PBT
UL 94 flammability rating		V-0
Contact base material		Copper alloy
Material of contact surface		tinned
Pin dimensions = d	mm	
Solder eyelet Ø = D	mm	
Solder eyelet Ø tolerance	mm	

Accessories

Note: Refer to the Accessories chapter for additional accessories.

Screwdriver	Order No.
SDIS 0.6X3.5X100	9008390000
SDS 0.6X3.5X100	9008330000

Ordering data

Solder pin length				
Colour	Black			
Pitch	7.62 mm			
Pol.	L1	(inch)	Qty.	Order No.
2	7.62	0.300	126	1043590000
3	15.24	0.600	84	1043600000
4	22.86	0.900	60	1043610000
5	30.48	1.200	48	1043620000

Representative deratings curve

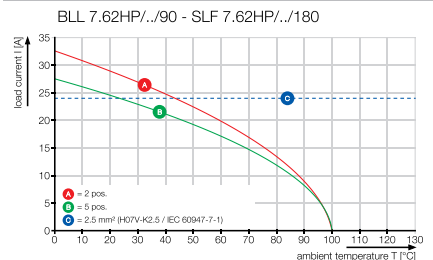

SLF 7.62HP../180F



Dimensioned drawing

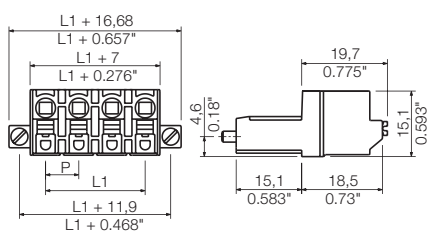

SLF 7.62HP../180LR



Dimensioned drawing

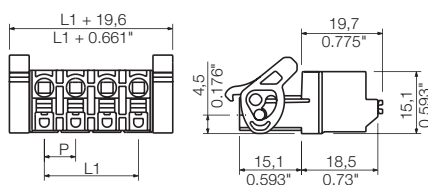

Ordering data

Solder pin length					
Colour					Black
Pitch 7.62 mm					
Pol.	L1	(inch)	Qty.	Order No.	
2	7.62	0.300	72	1043670000	
3	15.24	0.600	54	1043680000	
4	22.86	0.900	42	1043690000	
5	30.48	1.200	36	1043700000	

Ordering data

Solder pin length					
Colour					Black
Pitch 7.62 mm					
Pol.	L1	(inch)	Qty.	Order No.	
2	7.62	0.300	72	1043750000	
3	15.24	0.600	54	1043760000	
4	22.86	0.900	42	1043770000	
5	30.48	1.200	36	1043780000	

Additional deratings curves

BLL 7.62HP../90 - SLF 7.62HP../180

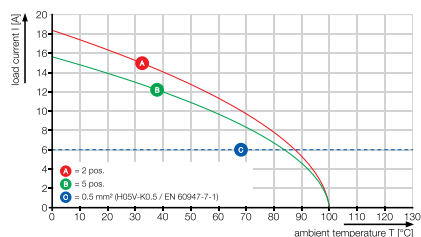

Connectors in 7.62 mm pitch
Series BL/SL 7.62 – connects up to 4 mm²

BLZ 7.62HP../180

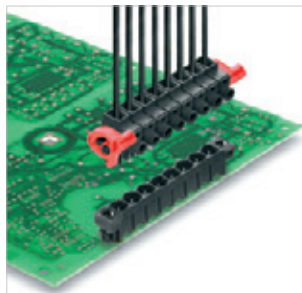

Female plug with clamping-yoke screw connection in 180° outlet direction. Complies with UL1059 600 V Use Group C and IEC 61800-5-1 requirements for 3 mm of finger safety on 400 V TNC(S) systems.

- Available with lock and release-levers (LR) and screw flange on request.

Product data

IEC: 630 V / 29 A / 0.2 - 4 mm²
 UL: 600 V / 20 A / AWG 20 - 12

For additional articles and information, refer to catalog.weidmueller.com

Note:

- Additional colours on request
- Gold-plated contact surfaces on request
- Rated current related to rated cross-section & min. No. of poles.
- Wire end ferrule without plastic collar to DIN 46228/1
- Wire end ferrule with plastic collar to DIN 46228/4
- P on drawing = pitch
- Rated data refer only to the component itself. Clearance and creepage distances to other components are to be designed in accordance with the relevant application standards.

BLZ 7.62HP../180



Dimensioned drawing

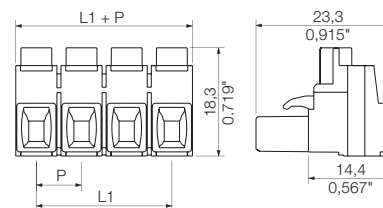



Technical data

In compliance with IEC 60664-1 / IEC 61984

Clamping range, max.	mm ²	0.08...4
Solid core H05(07) V-U	mm²	0.2...4
Stranded H07 V-R		
Flexible H05(07) V-K	mm ²	0.2...4
Flexible with ferrule	mm ²	0.2...2.5
Ferrule with plastic collar	mm ²	0.2...2.5
Stripping length	mm	7
Screwdriver blade	mm	0.6 x 3.5
According to norm		DIN 5264
Tightening torque range	Nm	0.4...0.5
Rated current, max.	A	29 25
At ambient temperature	20°C	40°C
For conductor cross-section	mm ²	2.5
Overtoltage category		III III II
Pollution severity		3 2 2
Rated voltage	V	400 500 630
Rated impulse voltage	kV	6 6 4
UL / CUL (Use Group)	B C D	
Rated voltage	V	600 600 600
Rated current	A	20 20 5
AWG conductor	AWG	20-12
CSA (Use Group)	B C D	
Rated voltage	V	600 600 600
Rated current	A	20 20 5
AWG conductor	AWG	20-12
General data		
Type of insulation material		PBT
UL 94 flammability rating		V-0
Contact base material		Copper alloy
Material of contact surface		tinned
Pin dimensions = d	mm	
Solder eyelet Ø = D	mm	
Solder eyelet Ø tolerance	mm	

Accessories

Note: Refer to the Accessories chapter for additional accessories.

Coding		Order No.
	BLZ/SL KO OR	1573010000
	BLZ/SL KO SW	1545710000
Screwdriver		
	SDIS 0.6X3.5X100	9008390000
	SDS 0.6X3.5X100	9008330000

Ordering data

Solder pin length				
Colour	Black			
Pitch	7.62 mm			
Pol.	L1	(inch)	Qty.	Order No.
2	7.62	0.300	100	1059580000
3	15.24	0.600	100	1059590000
4	22.86	0.900	100	1059600000
5	30.48	1.200	50	1049010000
6	38.10	1.500	50	1049020000
7	45.72	1.800	50	1059610000
8	53.34	2.100	50	1049030000
9	60.96	2.400	50	1059620000
10	68.58	2.700	50	1059630000
11	76.20	3.000	50	1059640000
12	83.82	3.300	50	1059670000

Representative deratings curve

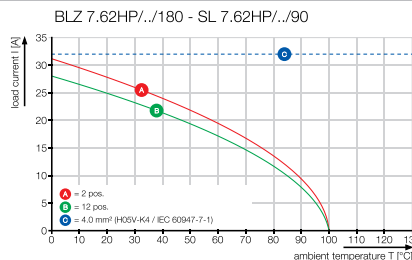

BLZ 7.62HP../180LR



Dimensioned drawing

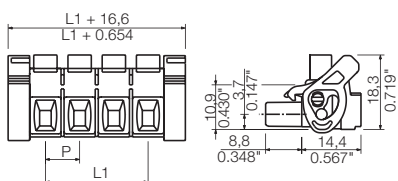

Ordering data

Solder pin length				
Colour				Black
Pitch 7.62 mm				
Pol.	L1	(inch)	Qty.	Order No.
2	7.62	0.300	60	1093430000
3	15.24	0.600	45	1093440000
4	22.86	0.900	35	1093450000
5	30.48	1.200	30	1093460000
6	38.10	1.500	25	1164960000
7	45.72	1.800	20	1164970000
8	53.34	2.100	20	1164980000
9	60.96	2.400	15	1164990000
10	68.58	2.700	15	1165000000
11	76.20	3.000	15	1165010000
12	83.82	3.300	15	1165020000

Additional deratings curves

BLZ 7.62HP../180 - SL 7.62HP../90

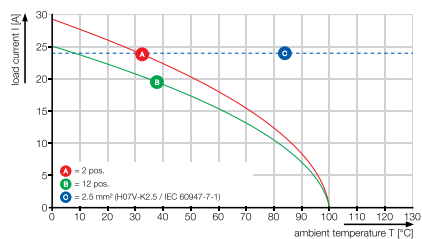

Connectors in 7.62 mm pitch
Series BL/SL 7.62 – connects up to 4 mm²

BLF 7.62HP../180

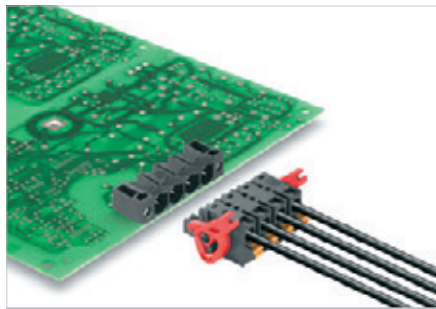

Female plug with PUSH IN spring connection in 180 ° outlet direction. Complies with UL1059 600 V Use Group C and IEC 61800-5-1 requirements for 3 mm of finger safety on 400 V TNC(S) systems.

- Available with screw flange (F) and lock and release-levers (LR).

Product data

IEC: 1000 V / 24 A / 0.5 - 2.5 mm²
 UL: 600 V / 20 A / AWG 20 - 12

For additional articles and information, refer to catalog.weidmueller.com

Note:

- Additional colours on request
- Gold-plated contact surfaces on request
- Rated current related to rated cross-section & min. No. of poles.
- Wire end ferrule without plastic collar to DIN 46228/1
- Wire end ferrule with plastic collar to DIN 46228/4
- P on drawing = pitch
- Rated data refer only to the component itself. Clearance and creepage distances to other components are to be designed in accordance with the relevant application standards.

BLF 7.62HP../180

with test point



Dimensioned drawing

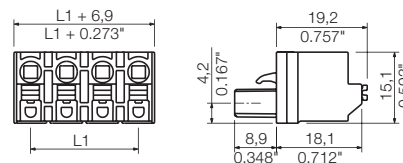



Technical data

In compliance with IEC 60664-1 / IEC 61984			
Clamping range, max.	mm ²	0.08...2.5	
Solid core H05(07) V-U	mm²	0.5...2.5	
Stranded H07 V-R			
Flexible H05(07) V-K	mm ²	0.5...2.5	
Flexible with ferrule	mm ²	0.5...2.5	
Ferrule with plastic collar	mm ²	0.5...2.5	
Stripping length	mm	10	
Screwdriver blade	mm	0.6 x 3.5	
According to norm		DIN 5264	
Tightening torque range	Nm		
Rated current, max.	A	24	23.8
At ambient temperature		20°C	40°C
For conductor cross-section	mm ²	2.5	
Overtoltage category		III	III II
Pollution severity		3	2 2
Rated voltage	V	630	1000 1000
Rated impulse voltage	kV	6	8 6
UL / CUL (Use Group)		B	C D
Rated voltage	V	600	600 600
Rated current	A	20	20 5
AWG conductor	AWG	20-12	
CSA (Use Group)		B	C D
Rated voltage	V	600	600 600
Rated current	A	21	21 5
AWG conductor	AWG	20-12	
General data			
Type of insulation material		PBT	
UL 94 flammability rating		V-0	
Contact base material		Copper alloy	
Material of contact surface		tinned	
Pin dimensions = d	mm		
Solder eyelet Ø = D	mm		
Solder eyelet Ø tolerance	mm		

Accessories

Note: Refer to the Accessories chapter for additional accessories.

Screwdriver		Order No.
	SDIS 0.5X3.0X100	9008380000
	SDS 0.5X3.0X80	9008320000
Crimping tool		
	PZ 6/5	9011460000

Ordering data

Solder pin length					
Colour					Black
Pitch 7.62 mm					
Pol.	L1	(inch)	Qty.	Order No.	
2	7.62	0.300	126	1043830000	
3	15.24	0.600	78	1043840000	
4	22.86	0.900	60	1043850000	
5	30.48	1.200	48	1043860000	
6	38.10	1.500	36	1227340000	
7	45.72	1.800	30	1227350000	
8	53.34	2.100	30	1227360000	
9	60.96	2.400	24	1227370000	
10	68.58	2.700	24	1227380000	
11	76.20	3.000	18	1227390000	
12	83.82	3.300	18	1227410000	

Representative deratings curve

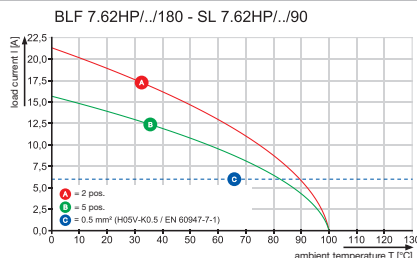

BLF 7.62HP../180F

with test point



Dimensioned drawing

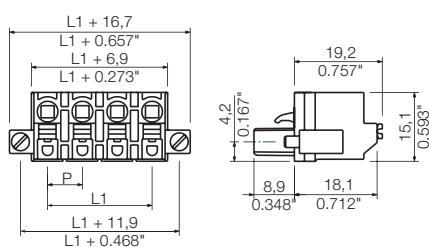

BLF 7.62HP../180LR

with test point



Dimensioned drawing

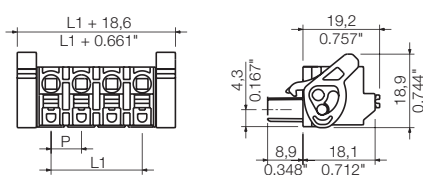

Ordering data

Solder pin length					
Colour					Black
Pitch 7.62 mm					
Pol.	L1	(inch)	Qty.	Order No.	
2	7.62	0.300	72	1043910000	
3	15.24	0.600	54	1043920000	
4	22.86	0.900	42	1043930000	
5	30.48	1.200	36	1043940000	
6	38.10	1.500	30	1227490000	
7	45.72	1.800	24	1227510000	
8	53.34	2.100	24	1227520000	
9	60.96	2.400	18	1227530000	
10	68.58	2.700	18	1227540000	

Ordering data

Solder pin length					
Colour					Black
Pitch 7.62 mm					
Pol.	L1	(inch)	Qty.	Order No.	
2	7.62	0.300	72	1043990000	
3	15.24	0.600	54	1044000000	
4	22.86	0.900	42	1044010000	
5	30.48	1.200	36	1044020000	
6	38.10	1.500	30	1227420000	
7	45.72	1.800	24	1227430000	
8	53.34	2.100	24	1227440000	
9	60.96	2.400	18	1227450000	
10	68.58	2.700	18	1227460000	

Additional deratings curves

BLF 7.62HP../180 - SL 7.62HP../190

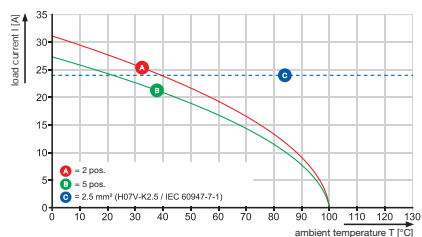

Connectors in 7.62 mm pitch
Series BL/SL 7.62 – connects up to 4 mm²

BLL 7.62HP../90

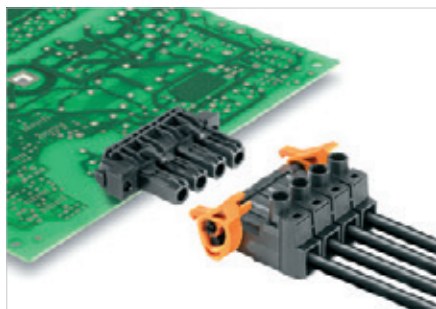

Touch-safe female header in 90° outlet direction. Meets the requirements of IEC 61800-5-1 and allows UL approval in accordance with UL508 / UL840 for 600 V. An ideal touch-safe solution for power output and DC link applications. According to IEC 61800-5-1, the mating profile ensures more than 3 mm of touch safety.

- Available with screw flange (F) and solder flange (LF).

Product data

IEC: 630 V / 24 A
 UL: 300 V / 20 A

For additional articles and information, refer to catalog.weidmueller.com

Note:

- Additional colours on request
- Gold-plated contact surfaces on request
- Spacing between rows: see hole layout
- Rated current related to rated cross-section & min. No. of poles.
- P on drawing = pitch
- Rated data refer only to the component itself. Clearance and creepage distances to other components are to be designed in accordance with the relevant application standards.

BLL 7.62HP../90G



Dimensioned drawing

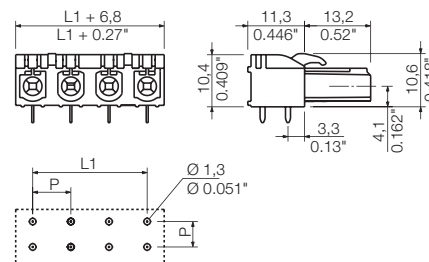

Technical data

In compliance with IEC 60664-1 / IEC 61984

Clamping range, max.	mm ²		
Solid core H05(07) V-U	mm²		
Stranded H07 V-R			
Flexible H05(07) V-K	mm ²		
Flexible with ferrule	mm ²		
Ferrule with plastic collar	mm ²		
Stripping length	mm		
Screwdriver blade	mm		
According to norm			
Tightening torque range	Nm		
Rated current, max.	A	24	24
At ambient temperature		20°C	40°C
For conductor cross-section	mm ²		
Overtoltage category		III	III II
Pollution severity		3	2 2
Rated voltage	V	400	630 630
Rated impulse voltage	kV	6	6 4
UL / CUL (Use Group)	B C D		
Rated voltage	V	300	150 300
Rated current	A	20	20 10
AWG conductor	AWG		-
CSA (Use Group)	B C D		
Rated voltage	V	300	150 300
Rated current	A	20	20 10
AWG conductor	AWG		-
General data			
Type of insulation material		PA GF	
UL 94 flammability rating		V-0	
Contact base material		Copper alloy	
Material of contact surface		tinned	
Pin dimensions = d	mm	0.4 x 1.00	
Solder eyelet Ø = D	mm	1.3	
Solder eyelet Ø tolerance	mm	+ 0,1	

Accessories

Note: Refer to the Accessories chapter for additional accessories.

Ordering data

Solder pin length	3.2 mm		
Colour	Black		
Pitch	7.62 mm		
Pol.	L1	(inch)	Qty. Order No.
2	7.62	0.300	126 1043230000
3	15.24	0.600	84 1043240000
4	22.86	0.900	60 1043250000
5	30.48	1.200	48 1043260000

Representative deratings curve

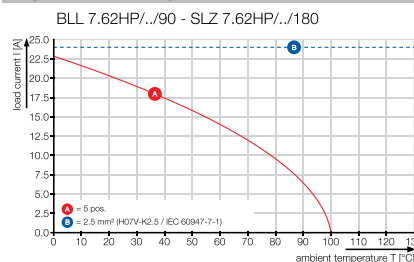

BLL 7.62HP../90F



BLL 7.62HP../90LF



Dimensioned drawing

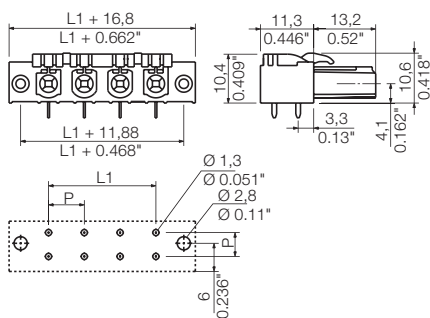

Dimensioned drawing

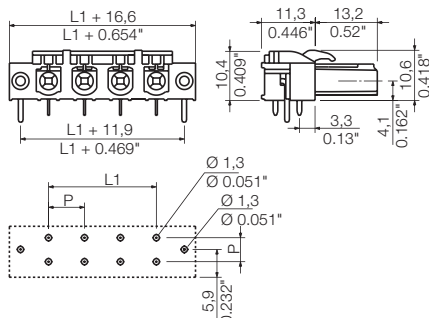

Ordering data

Solder pin length		3.2 mm			
Colour		Black			
Pitch		7.62 mm			
Pol.	L1	(inch)	Qty.	Order No.	
2	7.62	0.300	72	1043270000	
3	15.24	0.600	54	1043280000	
4	22.86	0.900	42	1043290000	
5	30.48	1.200	36	1043300000	

Ordering data

Solder pin length		3.2 mm			
Colour		Black			
Pitch		7.62 mm			
Pol.	L1	(inch)	Qty.	Order No.	
2	7.62	0.300	72	1095640000	
3	15.24	0.600	54	1095650000	
4	22.86	0.900	42	1095660000	
5	30.48	1.200	36	1095670000	

Additional deratings curves

BLL 7.62HP../90 - SLF 7.62HP../180

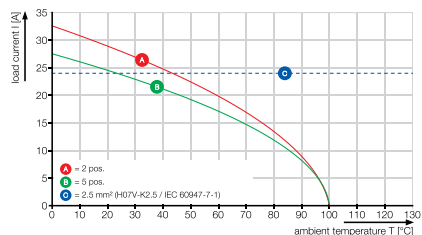

BLL 7.62HP../90 - SLZ 7.62HP../180

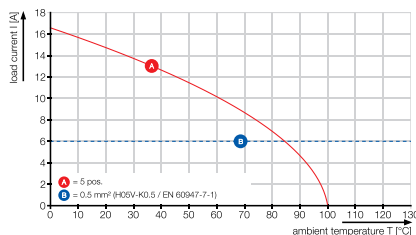

Connectors in 7.62 mm pitch
Series BL/SL 7.62 – connects up to 4 mm²

BLL 7.62HP../180

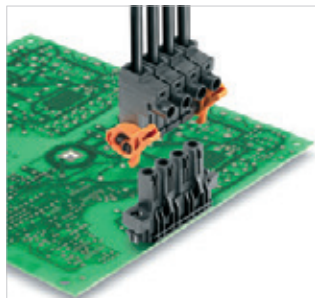

Touch-safe female header in 180° outlet direction. Meets the requirements of IEC 61800-5-1 and allows UL approval in accordance with UL508 / UL840 for 600 V. An ideal touch-safe solution for power output and DC link applications. According to IEC 61800-5-1, the mating profile ensures more than 3 mm of touch safety.

- Available with screw flange (F) and solder flange (LF).

Product data

IEC: 630 V / 24 A
 UL: 300 V / 20 A

For additional articles and information, refer to catalog.weidmueller.com

Note:

- Additional colours on request
- Gold-plated contact surfaces on request
- Spacing between rows: see hole layout
- Rated current related to rated cross-section & min. No. of poles.
- P on drawing = pitch
- Rated data refer only to the component itself. Clearance and creepage distances to other components are to be designed in accordance with the relevant application standards.

BLL 7.62HP../180G



Dimensioned drawing

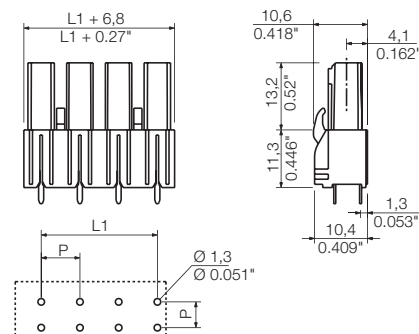

Technical data

In compliance with IEC 60664-1 / IEC 61984			
Clamping range, max.	mm ²		
Solid core H05(07) V-U	mm²		
Stranded H07 V-R			
Flexible H05(07) V-K	mm ²		
Flexible with ferrule	mm ²		
Ferrule with plastic collar	mm ²		
Stripping length	mm		
Screwdriver blade	mm		
According to norm			
Tightening torque range	Nm		
Rated current, max.	A	24	24
At ambient temperature		20°C	40°C
For conductor cross-section	mm ²		
Overtoltage category		III	III II
Pollution severity		3	2 2
Rated voltage	V	400	630 630
Rated impulse voltage	kV	6	6 4
UL / CUL (Use Group)	B C D		
Rated voltage	V	300	150 300
Rated current	A	20	20 10
AWG conductor	AWG		-
CSA (Use Group)	B C D		
Rated voltage	V	300	150 300
Rated current	A	20	20 10
AWG conductor	AWG		-
General data			
Type of insulation material		PA GF	
UL 94 flammability rating		V-0	
Contact base material		Copper alloy	
Material of contact surface		tinned	
Pin dimensions = d	mm	0.4 x 1.00	
Solder eyelet Ø = D	mm	1.3	
Solder eyelet Ø tolerance	mm	+ 0,1	

Accessories

Note: Refer to the Accessories chapter for additional accessories.

Ordering data

Solder pin length		3.2 mm	
Colour		Black	
Pitch		7.62 mm	
Pol.	L1	(inch)	Qty. Order No.
2	7.62	0.300	126 1122070000
3	15.24	0.600	84 1122080000
4	15.24	0.600	60 1122090000
5	30.48	1.200	48 1122100000

Representative deratings curve

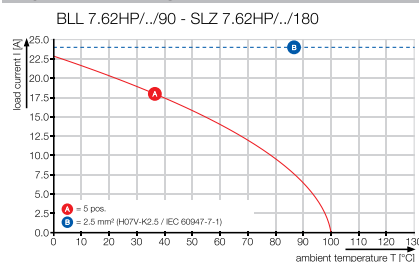

BLL 7.62HP../180F



Dimensioned drawing

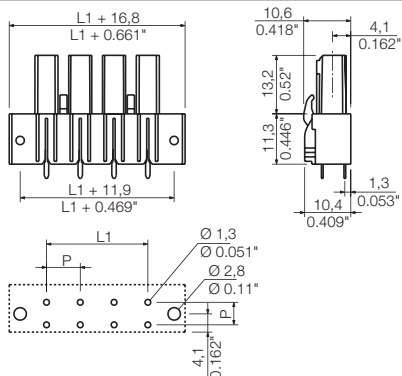

Ordering data

Solder pin length		3.2 mm	
Colour		Black	
Pitch		7.62 mm	
Pol.	L1	(inch)	Qty. Order No.
2	7.62	0.300	72 1122110000
3	15.24	0.600	54 1122120000
4	22.86	0.900	42 1122130000
5	30.48	1.200	36 1122140000

BLL 7.62HP../180LF



Dimensioned drawing

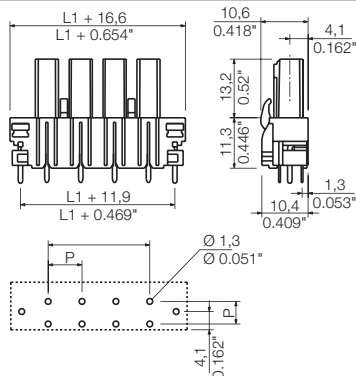

Ordering data

Solder pin length		3.2 mm	
Colour		Black	
Pitch		7.62 mm	
Pol.	L1	(inch)	Qty. Order No.
2	7.62	0.300	72 1134080000
3	15.24	0.600	54 1134090000
4	22.86	0.900	42 1134110000
5	30.48	1.200	36 1134120000

Additional deratings curves

BLL 7.62HP../90 - SLF 7.62HP../180

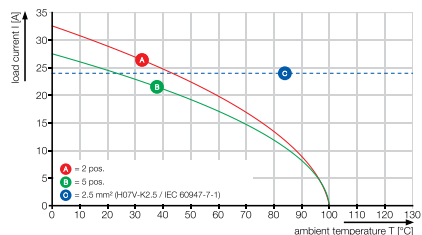

BLL 7.62HP../90 - SLZ 7.62HP../180

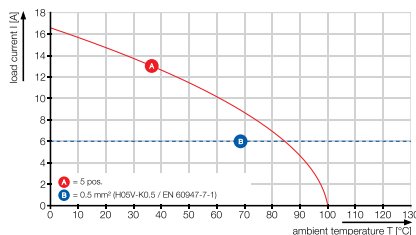

OMNIMATE Power BV / SV 7.62HP – the 28 kVA power class

Custom-fit high-powered solutions

More power reserves for more load capacity: The OMNIMATE Power SV / BV 7.62HP mid-level class of power connection systems is the top performer of the HP series. It features a large clamping range, increased overload capacity and the widest selection of variants and accessories.

HP means High Performance – this performance covers a great deal: the full rated current up to 50 °C without derating, unlimited 600 V approval according to UL, and the additional finger safety for 400 V-TN systems (+ 3.0 mm) in compliance with the application directive IEC 61800-5-1.

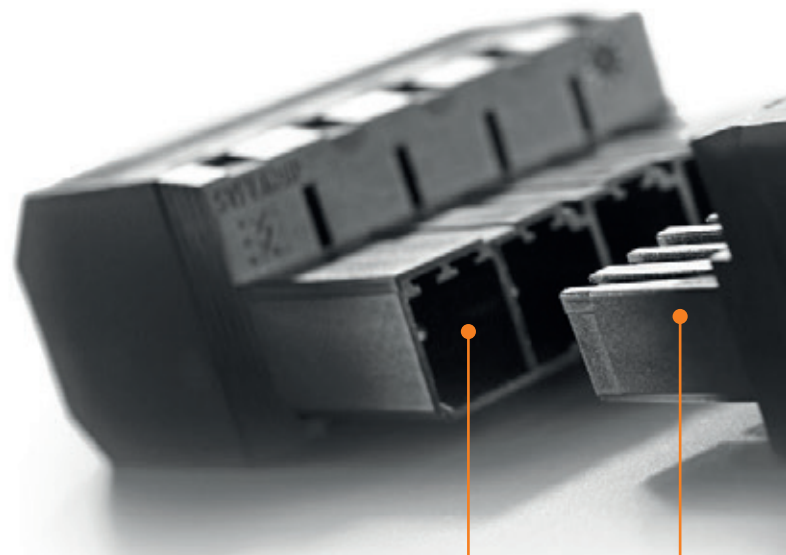

Maximum safety

Safe for both man and machine with bi-directional finger safety: also when not plugged in and covering inverse voltages from power electronics.

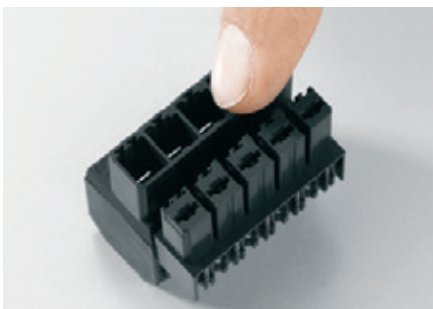

Maximum performance

Full current rating at 40 °C ambient temperature is a mandatory requirement in drive applications. What really makes the difference here is real-world, application-based overload and over-heating capacities.

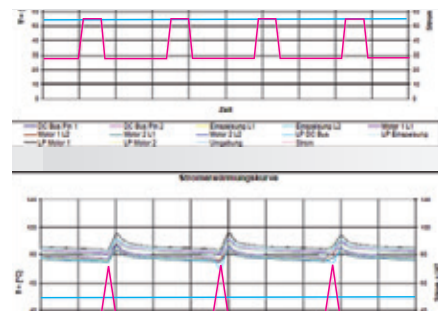

Maximum user-friendliness

Quick, simple plug and release: with the one-handed safety flange – convenient for the user and safe for the application.

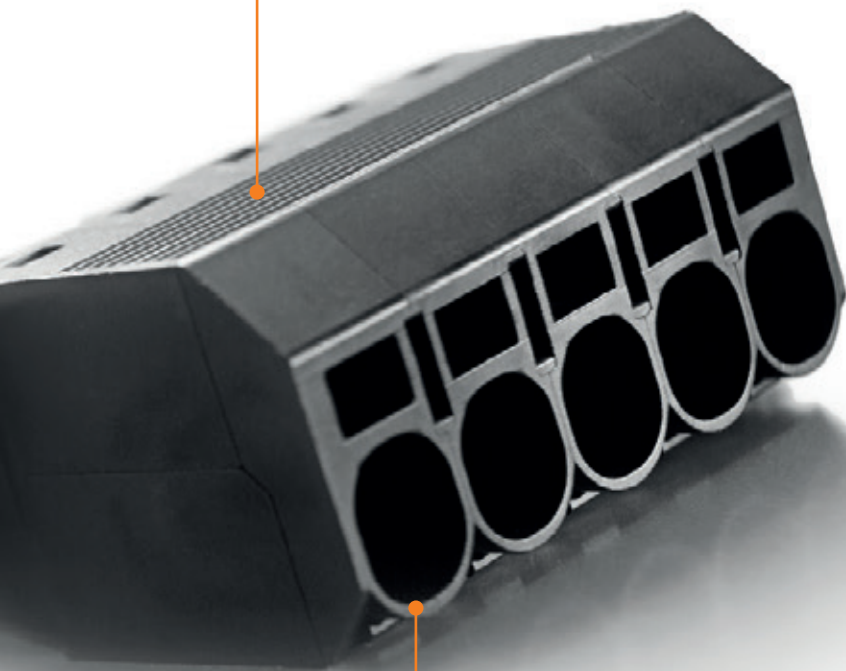
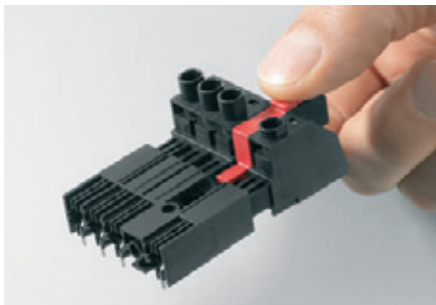

Maximum efficiency

Tool-free simplicity: quick PUSH IN connection mechanism and automatic, convenient snap-in with one-handed safety interlock.

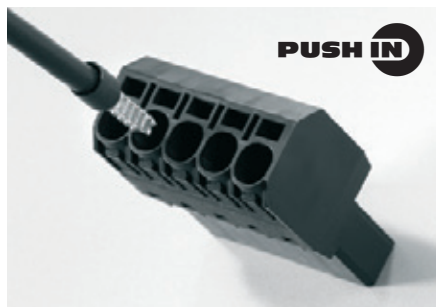

High system performance

An overview of the 28-kVA class of OMNIMATE Power: The HP system has been leading the way with its tool-free rapid interlock, installation-safe creepage and clearance distances, and application-based versioning scheme. This integrated strategy of system expansion includes a one-handed safety flange and wide range of innovative extras.







Individualised configuration

Standard + Services = custom design with simple configuration across the entire range of services: features include colour coding, application-oriented labelling and custom modifications or design. More information can be found in the "Services & Support" brochure (Order number 10777670000).



<http://www.OMNIMATE.net>

-  = Wire-to-Board
-  = Board-to-Board
-  = Wire-to-Wire
-  = Board-to-Wire

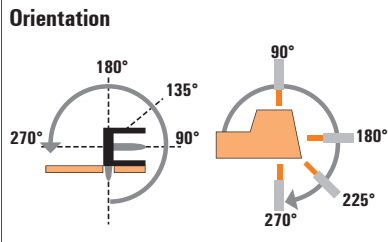

Male header



Solder connection

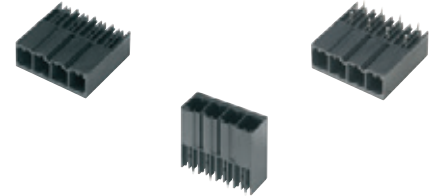

BV/SV 7.62 series



Type	SV	SV	SV
Orientation	90°	180°	270°
Flange options	G/F/SF/MF/ MSF	G/F/SF/MF/ MSF	G/F/SF/MF/ MSF
Product code numbers	IEC: 1.000 V/41 A UL: 300 V/35 A	IEC: 1.000 V/41 A UL: 300 V/35 A	IEC: 1.000 V/41 A UL: 300 V/35 A
Page	F.28	F.30	F.34

		SV	SV	SV		
Female plug						
	 BVZ 180° (G)/F/SF	IEC: 1.000 V/41 A/0.2 - 6 mm ² UL: 600 V/35 A/AWG 24 - 10	F.58			
	 BVZ 180° FC/SFC	IEC: 1.000 V/41 A/0.2 - 6 mm ² UL: 600 V/35 A/AWG 24 - 10	F.59			
	 BVZ 180° SH...	IEC: 1.000 V/41 A/0.2 - 6 mm ² UL: 600 V/35 A/AWG 24 - 10	F.60			
	 BVZ 180° SH... C	IEC: 1.000 V/41 A/0.2 - 6 mm ² UL: 600 V/35 A/AWG 24 - 10	F.62			
Spring PUSH IN						
 BVF 180° (G)/F/SF/MF/MSF	IEC: 1.000 V/41 A/0.2 - 10 mm ² UL: 600 V/35 A/AWG 24 - 10	F.65				
Female header						
	 BVL 90° (G)/FI/SFI	IEC: 1.000 V/41 A UL: 300 V/35 A	F.70			
	 BVL 180° (G)/FI/SFI	IEC: 1.000 V/41 A UL: 300 V/35 A	F.72			
 BVL 270° (G)/FI/SFI	IEC: 1.000 V/41 A UL: 300 V/35 A	F.74				

Female plug and header:

- (G) = Closed (without flange)
- F = Flange with clasp
- SF = Flange with clasp and additional screw
- SFC = Flange with clasp and additional screw
- FI = Inverted flange with clasp
- SFI = Inverted flange with clasp and additional screw

- FC = Flange with clasp
- SH... = Shielded flange with additional nut
- SH... C = Shielded flange with additional screw
- MF = Centre flange for clasp
- MSF = Centre flange for clasp with additional nut

Male plug



Screw Clamping yoke



Spring PUSH IN

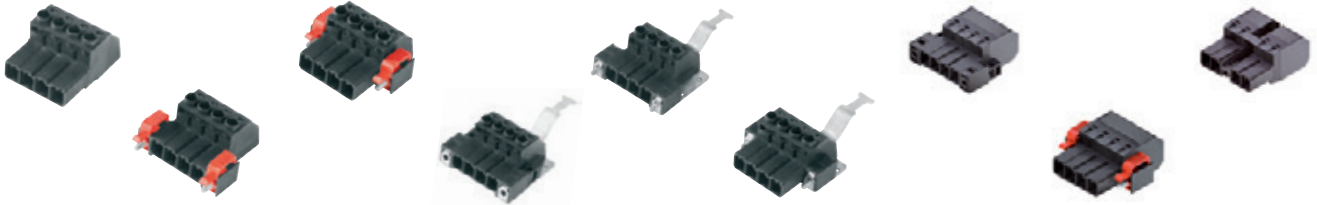

	SVZ	SVZ	SVZ	SVZ	SVZ	SVZ	SVF	SVF	SVF
	180°	180°	180°	180°	180°	180°	180°	180°	180°
	G/F/SF	G/FC/SFC	G/FI/SFI	SH	SH	SH	G/F/SF	G/FI/SFI	MF/MSF
	IEC: 1.000 V/41 A/ 0.2 - 6 mm ² UL: 600 V/35 A/ AWG 24 - 10	IEC: 1.000 V/41 A/ 0.2 - 6 mm ² UL: 600 V/35 A/ AWG 24 - 10	IEC: 1.000 V/41 A/ 0.2 - 6 mm ² UL: 600 V/35 A/ AWG 24 - 10	IEC: 1.000 V/41 A/ 0.2 - 6 mm ² UL: 600 V/35 A/ AWG 24 - 10	IEC: 1.000 V/41 A/ 0.2 - 6 mm ² UL: 600 V/35 A/ AWG 24 - 10	IEC: 1.000 V/41 A/ 0.2 - 6 mm ² UL: 600 V/35 A/ AWG 24 - 10	IEC: 1.000 V/41 A/ 0.5 - 10 mm ² UL: 600 V/35 A/ AWG 24 - 10	IEC: 1.000 V/41 A/ 0.5 - 10 mm ² UL: 600 V/35 A/ AWG 24 - 10	IEC: 1.000 V/41 A/ 0.5 - 10 mm ² UL: 600 V/35 A/ AWG 24 - 10
	F.38	F.41	F.43	F.44	F.46	F.48	F.50	F.53	F.56
	●			●	●		●		
		●			●				
	●			●			●		
		●							
	●			●	●		●		●
	●		●			●		●	
	●		●			●		●	
	●		●			●		●	

F

Male header and plug:

- G = Closed (without flange)
- F = Flange with clasp
- SF = Flange with clasp and additional screw
- FI = Inverted flange with clasp
- SFI = Inverted flange with clasp and additional screw
- FC = Flange with clasp

- SFC = Flange with clasp and additional screw
- SH... = Shielded flange with additional nut
- MF = Centre flange for clasp
- MSF = Centre flange for clasp with additional nut

Connectors in 7.62 mm pitch
Series BV/SV 7.62 – connects up to 6 mm²

SV 7.62HP../90



Male header in 90° outlet direction for 400 V TNC (S) systems. UL approved for 600 V in accordance with UL508 / UL840. The mating profile ensures touch-safety of more than 3 mm according to IEC 61800-5-1.

Maximum operational reliability: with a derating up to 125 °C, a mating profile that can only be plugged in correct, unique coding capability and additional fastening mechanism.

- Available with a flange (F), screw flange (SF) and middle screw flange (MF).

Product data

IEC: 1000 V / 41 A
 UL: 300 V / 35 A

For additional articles and information, refer to catalog.weidmueller.com

Note:

- Additional colours on request
- Rated current related to rated cross-section & min. No. of poles.
- P on drawing = pitch
- Rated data refer only to the component itself. Clearance and creepage distances to other components are to be designed in accordance with the relevant application standards.

SV 7.62HP../90G



Dimensioned drawing

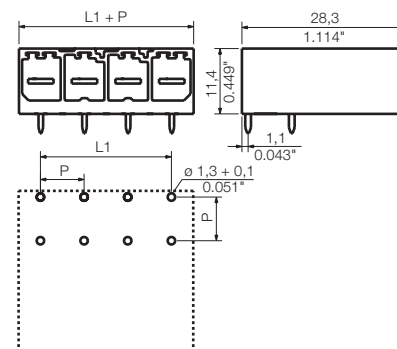

Technical data

In compliance with IEC 60664-1 / IEC 61984			
Clamping range, max.	mm ²		
Solid core H05(07) V-U	mm²		
Stranded H07 V-R			
Flexible H05(07) V-K	mm ²		
Flexible with ferrule	mm ²		
Ferrule with plastic collar	mm ²		
Stripping length	mm		
Screwdriver blade	mm		
According to norm			
Tightening torque range	Nm		
Rated current, max.	A	41	41
At ambient temperature		20°C	40°C
For conductor cross-section	mm ²		
Overvoltage category		III	III II
Pollution severity		3	2 2
Rated voltage	V	630	630 1000
Rated impulse voltage	kV	6	6 6
UL / CUL (Use Group)		B	C D
Rated voltage	V	300	300 600
Rated current	A	35	35 5
AWG conductor	AWG		-
CSA (Use Group)		B	C D
Rated voltage	V	300	300 600
Rated current	A	35	35 5
AWG conductor	AWG		-
General data			
Type of insulation material		PA GF	
UL 94 flammability rating		V-0	
Contact base material		Copper alloy	
Material of contact surface		tinned	
Pin dimensions = d	mm	0.8 x 1.0	
Solder eyelet Ø = D	mm	1.3	
Solder eyelet Ø tolerance	mm	+ 0,1	

Accessories

Note: Refer to the Accessories chapter for additional accessories.

Coding	Order No.
BV/SV 7.62HP K0	1937590000

Ordering data

Solder pin length		3.5 mm		
Colour		Black		
Pitch		7.62 mm		
Pol.	L1	(inch)	Qty.	Order No.
2	7.62	0.300	100	1930270000
3	15.24	0.600	100	1930280000
4	22.86	0.900	100	1930290000
5	30.48	1.200	50	1930300000
6	38.10	1.500	50	1930310000
7	45.72	1.800	50	1930320000

SV 7.62HP../90F



Dimensioned drawing

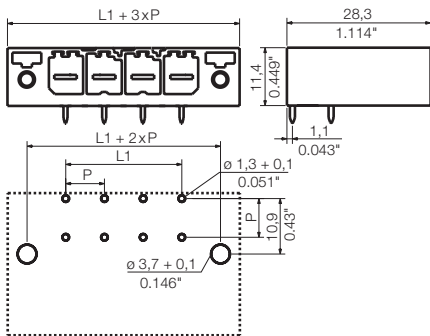

Ordering data

Solder pin length		3.5 mm		
Colour		Black		
Pitch		7.62 mm		
Pol.	L1	(inch)	Qty.	Order No.
2	7.62	0.300	100	1930380000
3	15.24	0.600	100	1930390000
4	22.86	0.900	100	1930400000
5	30.48	1.200	50	1930410000
6	38.10	1.500	50	1930420000
7	45.72	1.800	50	1930430000

SV 7.62HP../90SF



Dimensioned drawing

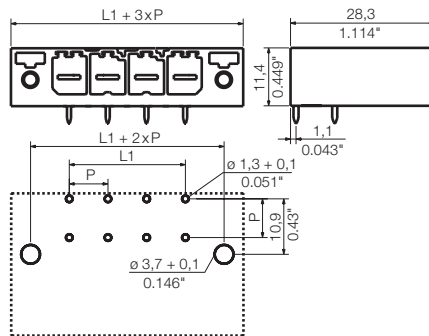

Ordering data

Solder pin length		3.5 mm		
Colour		Black		
Pitch		7.62 mm		
Pol.	L1	(inch)	Qty.	Order No.
2	7.62	0.300	100	1930490000
3	15.24	0.600	100	1930500000
4	22.86	0.900	100	1930510000
5	30.48	1.200	50	1930520000
6	38.10	1.500	50	1930530000
7	45.72	1.800	50	1930540000

SV 7.62HP../90MF



Dimensioned drawing

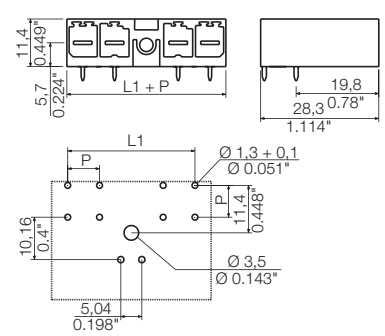

Ordering data

Solder pin length		3.5 mm		
Colour		Black		
Pitch		7.62 mm		
Pol.	L1	(inch)	Qty.	Order No.
2	15.24	0.600	78	1048390000
3	22.86	0.900	60	1048500000
3	22.86	0.900	60	1048490000
4	30.48	1.200	48	1048570000
5	38.10	1.500	36	1048690000
5	38.10	1.500	36	1048680000
6	45.72	1.800	30	1048760000

Connectors in 7.62 mm pitch
Series BV/SV 7.62 – connects up to 6 mm²

SV 7.62HP../180



Male header in 180° outlet direction for 400 V TNC (S) systems. UL approved for 600 V in accordance with UL508 / UL840. The mating profile ensures touch-safety of more than 3 mm according to IEC 61800-5-1.

Maximum operational reliability: with a derating up to 125 °C, a mating profile that can only be plugged in correct, unique coding capability, additional fastening mechanism, and integrated positioning.

- Available with a flange (F), screw flange (SF) and middle screw flange (MF).

Product data

IEC: 1000 V / 41 A
 UL: 300 V / 35 A

For additional articles and information, refer to catalog.weidmueller.com

Note:

- Additional colours on request
- Rated current related to rated cross-section & min. No. of poles.
- P on drawing = pitch
- Rated data refer only to the component itself. Clearance and creepage distances to other components are to be designed in accordance with the relevant application standards.

SV 7.62HP../180G



Dimensioned drawing

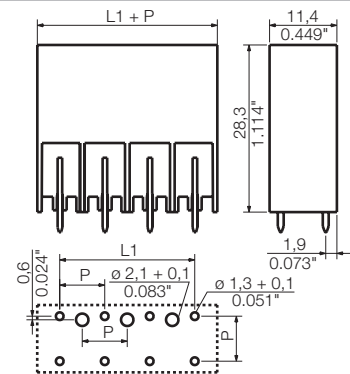

Technical data

In compliance with IEC 60664-1 / IEC 61984			
Clamping range, max.	mm ²		
Solid core H05(07) V-U	mm²		
Stranded H07 V-R			
Flexible H05(07) V-K	mm ²		
Flexible with ferrule	mm ²		
Ferrule with plastic collar	mm ²		
Stripping length	mm		
Screwdriver blade	mm		
According to norm			
Tightening torque range	Nm		
Rated current, max.	A	41	41
At ambient temperature		20°C	40°C
For conductor cross-section	mm ²		
Overvoltage category		III	III II
Pollution severity		3	2 2
Rated voltage	V	630	630 1000
Rated impulse voltage	kV	6	6 6
UL / CUL (Use Group)		B	C D
Rated voltage	V	300	300 600
Rated current	A	35	35 5
AWG conductor	AWG		-
CSA (Use Group)		B	C D
Rated voltage	V	300	300 600
Rated current	A	35	35 5
AWG conductor	AWG		-
General data			
Type of insulation material		PA GF	
UL 94 flammability rating		V-0	
Contact base material		Copper alloy	
Material of contact surface		tinned	
Pin dimensions = d	mm	0.8 x 1.0	
Solder eyelet Ø = D	mm	1.3	
Solder eyelet Ø tolerance	mm	+ 0,1	

Accessories

Note: Refer to the Accessories chapter for additional accessories.

Coding		Order No.
	BV/SV 7.62HP K0	1937590000
Protection against twisting		
	VDS180 SV7.62	1853940000

Ordering data

Solder pin length		3.5 mm		
Colour		Black		
Pitch		7.62 mm		
Pol.	L1	(inch)	Qty.	Order No.
2	7.62	0.300	100	1930600000
3	15.24	0.600	100	1930610000
4	22.86	0.900	100	1930620000
5	30.48	1.200	50	1930630000
6	38.10	1.500	50	1930640000
7	45.72	1.800	50	1930650000

SV 7.62HP../180F



SV 7.62HP../180SF



Dimensioned drawing

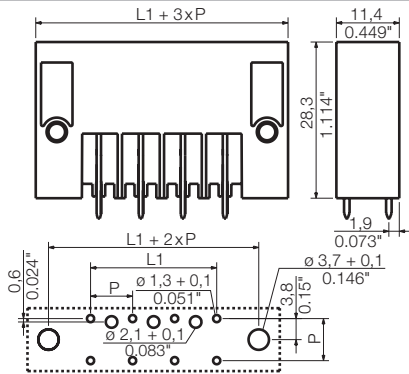

Dimensioned drawing

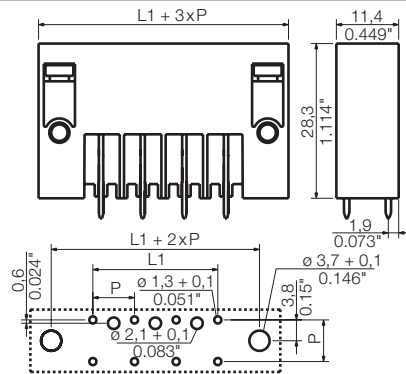

Ordering data

Solder pin length		3.5 mm		
Colour		Black		
Pitch		7.62 mm		
Pol.	L1	(inch)	Qty.	Order No.
2	7.62	0.300	100	1930710000
3	15.24	0.600	100	1930720000
4	22.86	0.900	100	1930730000
5	30.48	1.200	50	1930740000
6	38.10	1.500	50	1930750000
7	45.72	1.800	50	1930760000

Ordering data

Solder pin length		3.5 mm		
Colour		Black		
Pitch		7.62 mm		
Pol.	L1	(inch)	Qty.	Order No.
2	7.62	0.300	100	1930820000
3	15.24	0.600	100	1930830000
4	22.86	0.900	100	1930840000
5	30.48	1.200	50	1930850000
6	38.10	1.500	50	1930860000
7	45.72	1.800	50	1930870000

Connectors in 7.62 mm pitch
Series BV/SV 7.62 – connects up to 6 mm²

SV 7.62HP/./180MF

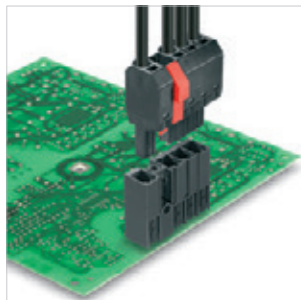

Male header in 180° outlet direction for 400 V TNC (S) systems. UL approved for 600 V in accordance with UL508 / UL840. The mating profile ensures touch-safety of more than 3 mm according to IEC 61800-5-1.

Maximum operational reliability: with a derating up to 125 °C, a mating profile that can only be plugged in correct, unique coding capability, additional fastening mechanism, and integrated positioning.

- Middle flange available in positions 2, 3 and 4.

Product data

IEC: 1000 V / 41 A
 UL: 300 V / 35 A

For additional articles and information, refer to catalog.weidmueller.com

Note:

- Additional colours on request
- Rated current related to rated cross-section & min. No. of poles.
- P on drawing = pitch
- Rated data refer only to the component itself. Clearance and creepage distances to other components are to be designed in accordance with the relevant application standards.

SV 7.62HP/./180MF2



Dimensioned drawing

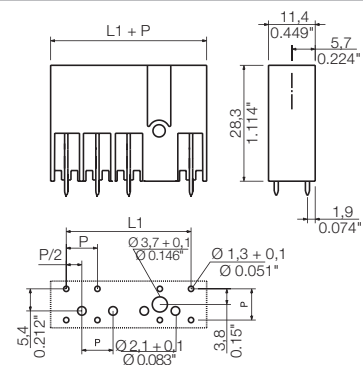



Technical data

In compliance with IEC 60664-1 / IEC 61984			
Clamping range, max.	mm ²		
Solid core H05(07) V-U	mm²		
Stranded H07 V-R			
Flexible H05(07) V-K	mm ²		
Flexible with ferrule	mm ²		
Ferrule with plastic collar	mm ²		
Stripping length	mm		
Screwdriver blade	mm		
According to norm			
Tightening torque range	Nm		
Rated current, max.	A	41	41
At ambient temperature		20°C	40°C
For conductor cross-section	mm ²		
Overvoltage category		III	III II
Pollution severity		3	2 2
Rated voltage	V	630	630 1000
Rated impulse voltage	kV	6	6 6
UL / CUL (Use Group)		B	C D
Rated voltage	V	300	300 600
Rated current	A	35	35 5
AWG conductor	AWG		-
CSA (Use Group)		B	C D
Rated voltage	V	300	300 600
Rated current	A	35	35 5
AWG conductor	AWG		-
General data			
Type of insulation material		PA GF	
UL 94 flammability rating		V-0	
Contact base material		Copper alloy	
Material of contact surface		tinned	
Pin dimensions = d	mm	0.8 x 1.0	
Solder eyelet Ø = D	mm	1.3	
Solder eyelet Ø tolerance	mm	+ 0,1	

Accessories

Note: Refer to the Accessories chapter for additional accessories.

Coding		Order No.
	BV/SV 7.62HP K0	1937590000
	VDS180 SV7.62	1853940000

Ordering data

Solder pin length		3.5 mm	
Colour		Black	
Pitch 7.62 mm			
Pol.	L1	(inch)	Qty. Order No.
2	15.24	0.600	78 1048350000
3	22.86	0.900	60 1048410000

SV 7.62HP/./180MF3



SV 7.62HP/./180MF4



Dimensioned drawing

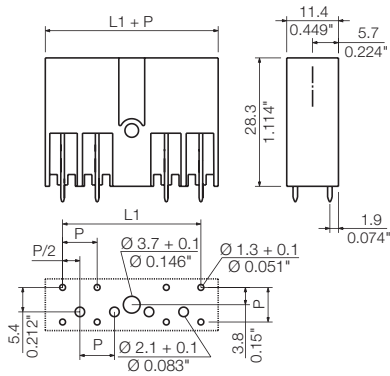

Dimensioned drawing

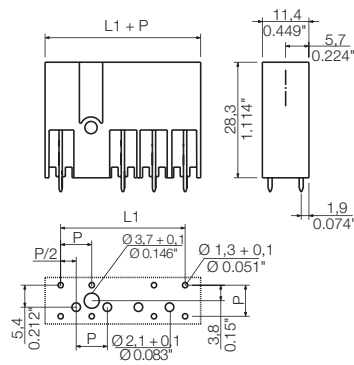

Ordering data

Solder pin length		3.5 mm		
Colour		Black		
Pitch		7.62 mm		
Pol.	L1	(inch)	Qty.	Order No.
3	22.86	0.900	60	1048420000
4	30.48	1.200	48	1048530000
5	38.10	1.500	36	1048590000

Ordering data

Solder pin length		3.5 mm		
Colour		Black		
Pitch		7.62 mm		
Pol.	L1	(inch)	Qty.	Order No.
5	38.10	1.500	36	1048600000
6	45.72	1.800	30	1048720000

Connectors in 7.62 mm pitch
Series BV/SV 7.62 – connects up to 6 mm²

SV 7.62HP../270

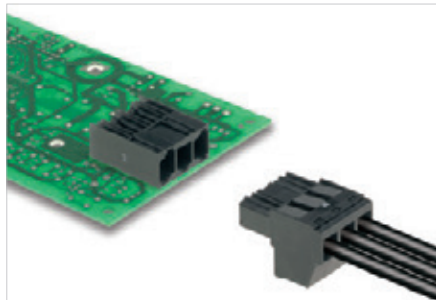

Male header in 270° outlet direction for 400 V TNC (S) systems. UL approved for 600 V in accordance with UL508 / UL840. The mating profile ensures touch-safety of more than 3 mm according to IEC 61800-5-1.

Maximum operational reliability: with a derating up to 125 °C, a mating profile that can only be plugged in correct, unique coding capability and additional fastening mechanism.

- Available with a flange (F), screw flange (SF) and middle screw flange (MF).

Product data

IEC: 1000 V / 41 A
 UL: 300 V / 35 A

For additional articles and information, refer to catalog.weidmueller.com

Note:

- Additional colours on request
- Rated current related to rated cross-section & min. No. of poles.
- P on drawing = pitch
- Rated data refer only to the component itself. Clearance and creepage distances to other components are to be designed in accordance with the relevant application standards.

SV 7.62HP../270G



Dimensioned drawing

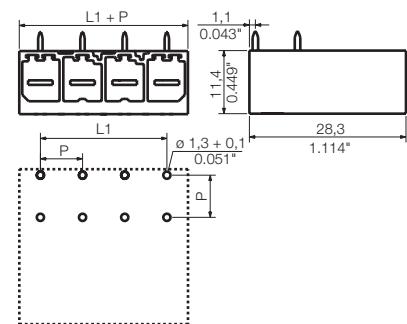

Technical data

In compliance with IEC 60664-1 / IEC 61984			
Clamping range, max.	mm ²		
Solid core H05(07) V-U	mm²		
Stranded H07 V-R			
Flexible H05(07) V-K	mm ²		
Flexible with ferrule	mm ²		
Ferrule with plastic collar	mm ²		
Stripping length	mm		
Screwdriver blade	mm		
According to norm			
Tightening torque range	Nm		
Rated current, max.	A	41	41
At ambient temperature		20°C	40°C
For conductor cross-section	mm ²		
Overvoltage category		III	III II
Pollution severity		3	2 2
Rated voltage	V	630	630 1000
Rated impulse voltage	kV	6	6 6
UL / CUL (Use Group)		B	C D
Rated voltage	V	300	300 600
Rated current	A	35	35 5
AWG conductor	AWG		-
CSA (Use Group)		B	C D
Rated voltage	V	300	300 600
Rated current	A	35	35 5
AWG conductor	AWG		-
General data			
Type of insulation material		PA GF	
UL 94 flammability rating		V-0	
Contact base material		Copper alloy	
Material of contact surface		tinned	
Pin dimensions = d	mm	0.8 x 1.0	
Solder eyelet Ø = D	mm	1.3	
Solder eyelet Ø tolerance	mm	+ 0,1	

Accessories

Note: Refer to the Accessories chapter for additional accessories.

Coding		Order No.
	BV/SV 7.62HP K0	1937590000

Ordering data

Solder pin length		3.5 mm		
Colour		Black		
Pitch		7.62 mm		
Pol.	L1	(inch)	Qty.	Order No.
2	7.62	0.300	100	1931260000
3	15.24	0.600	100	1931270000
4	22.86	0.900	100	1931280000
5	30.48	1.200	50	1931290000
6	38.10	1.500	50	1931300000
7	45.72	1.800	50	1931310000

SV 7.62HP../270F



SV 7.62HP../270SF



Dimensioned drawing

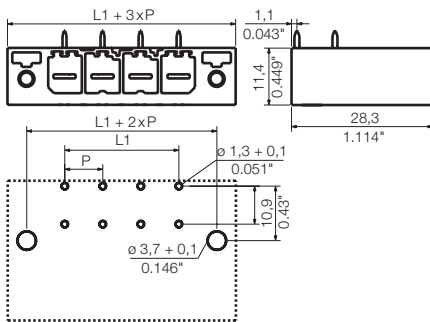

Dimensioned drawing

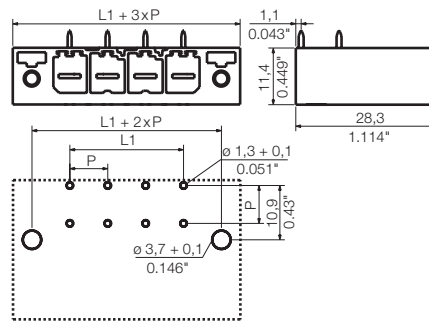

Ordering data

Solder pin length		3.5 mm		
Colour		Black		
Pitch		7.62 mm		
Pol.	L1	(inch)	Qty.	Order No.
2	7.62	0.300	100	1931370000
3	15.24	0.600	100	1931380000
4	22.86	0.900	100	1931390000
5	30.48	1.200	50	1931400000
6	38.10	1.500	50	1931410000
7	45.72	1.800	50	1931420000

Ordering data

Solder pin length		3.5 mm		
Colour		Black		
Pitch		7.62 mm		
Pol.	L1	(inch)	Qty.	Order No.
2	7.62	0.300	100	1931480000
3	15.24	0.600	100	1931490000
4	22.86	0.900	100	1931500000
5	30.48	1.200	50	1931510000
6	38.10	1.500	50	1931520000
7	45.72	1.800	50	1931530000

Connectors in 7.62 mm pitch
Series BV/SV 7.62 – connects up to 6 mm²

SV 7.62HP/./270MF

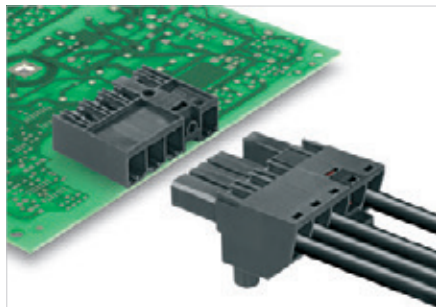

Male header in 180° outlet direction for 400 V TNC (S) systems. UL approved for 600 V in accordance with UL508 / UL840. The mating profile ensures touch-safety of more than 3 mm according to IEC 61800-5-1.

Maximum operational reliability: with a derating up to 125 °C, a mating profile that can only be plugged in correct, unique coding capability and additional fastening mechanism.

- Middle flange available in positions 2, 3 and 4.

Product data

IEC: 1000 V / 41 A
 UL: 300 V / 35 A

For additional articles and information, refer to catalog.weidmueller.com

Note:

- Additional colours on request
- Rated current related to rated cross-section & min. No. of poles.
- P on drawing = pitch
- Rated data refer only to the component itself. Clearance and creepage distances to other components are to be designed in accordance with the relevant application standards.

SV 7.62HP/./270MF2



Dimensioned drawing

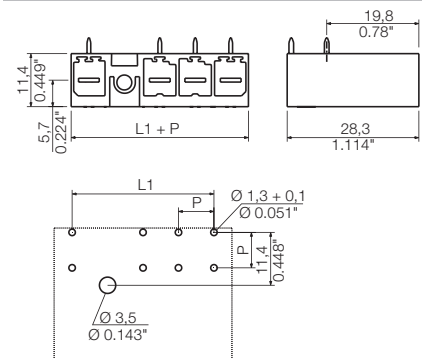

Technical data

In compliance with IEC 60664-1 / IEC 61984			
Clamping range, max.	mm ²		
Solid core H05(07) V-U	mm²		
Stranded H07 V-R			
Flexible H05(07) V-K	mm ²		
Flexible with ferrule	mm ²		
Ferrule with plastic collar	mm ²		
Stripping length	mm		
Screwdriver blade	mm		
According to norm			
Tightening torque range	Nm		
Rated current, max.	A	41	41
At ambient temperature		20°C	40°C
For conductor cross-section	mm ²		
Overvoltage category		III	III II
Pollution severity		3	2 2
Rated voltage	V	630	630 1000
Rated impulse voltage	kV	6	6 6
UL / CUL (Use Group)		B	C D
Rated voltage	V	300	300 600
Rated current	A	35	35 5
AWG conductor	AWG		-
CSA (Use Group)		B	C D
Rated voltage	V	300	300 600
Rated current	A	35	35 5
AWG conductor	AWG		-
General data			
Type of insulation material		PA GF	
UL 94 flammability rating		V-0	
Contact base material		Copper alloy	
Material of contact surface		tinned	
Pin dimensions = d	mm	0.8 x 1.0	
Solder eyelet Ø = D	mm	1.3	
Solder eyelet Ø tolerance	mm	+ 0,1	

Accessories

Note: Refer to the Accessories chapter for additional accessories.

Coding		Order No.
	BV/SV 7.62HP KO	1937590000

Ordering data

Solder pin length		3.5 mm		
Colour		Black		
Pitch		7.62 mm		
Pol.	L1	(inch)	Qty.	Order No.
2	15.24	0.600	78	1048370000
3	22.86	0.900	60	1048450000

SV 7.62HP/./270MF3



SV 7.62HP/./270MF4



Dimensioned drawing

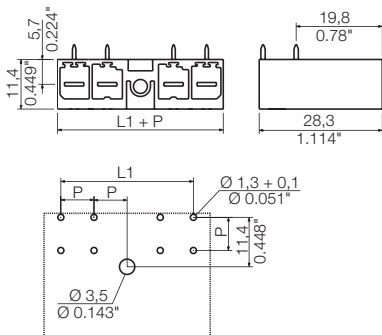

Dimensioned drawing

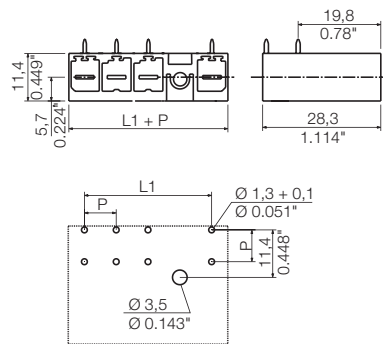

Ordering data

Solder pin length		3.5 mm		
Colour		Black		
Pitch		7.62 mm		
Pol.	L1	(inch)	Qty.	Order No.
3	22.86	0.900	60	1048460000
4	30.48	1.200	48	1048550000
5	38.10	1.500	36	1048640000

Ordering data

Solder pin length		3.5 mm		
Colour		Black		
Pitch		7.62 mm		
Pol.	L1	(inch)	Qty.	Order No.
5	38.10	1.500	36	1048650000
6	45.72	1.800	30	1048740000

Connectors in 7.62 mm pitch
Series BV/SV 7.62 – connects up to 6 mm²

SVZ 7.62HP../180

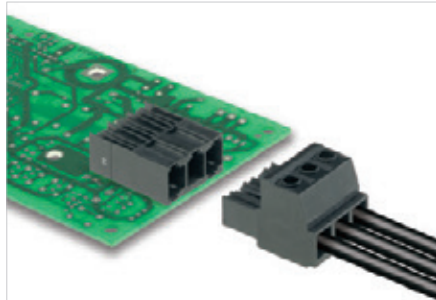

Male plug in 180° outlet direction with clamping yoke screw connection for TNC (S) systems. Also perfect for finger-safe solutions involving inverse voltages. Meets the requirements of UL1059 for 600 V Use Group C. The mating profile ensures touch-safety of > 3 mm in accordance with IEC 61800-5-1.

Maximum operational reliability: with a derating up to 125 °C, a mating profile that can only be plugged in correct, and unique coding capability.

- Available with a flange (F) and screw flange (SF).

Product data

IEC: 1000 V / 41 A / 0.2 - 6 mm²
 UL: 600 V / 35 A / AWG 24 - 10

For additional articles and information, refer to catalog.weidmueller.com

Note:

- Additional colours on request
- Rated current related to rated cross-section & min. No. of poles.
- Wire end ferrule without plastic collar to DIN 46228/1
- Wire end ferrule with plastic collar to DIN 46228/4
- P on drawing = pitch
- Rated data refer only to the component itself. Clearance and creepage distances to other components are to be designed in accordance with the relevant application standards.

SVZ 7.62HP../180



Dimensioned drawing

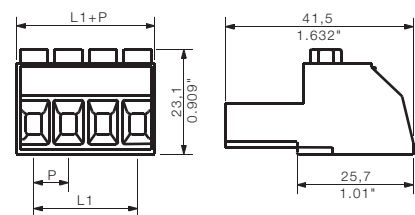

Technical data

In compliance with IEC 60664-1 / IEC 61984			
Clamping range, max.	mm ²	0.2...6	
Solid core H05(07) V-U	mm²	0.2...6	
Stranded H07 V-R			
Flexible H05(07) V-K	mm ²	0.5...6	
Flexible with ferrule	mm ²	0.25...6	
Ferrule with plastic collar	mm ²	0.25...6	
Stripping length	mm	12	
Screwdriver blade	mm	0.8 x 4.5	
According to norm		DIN 5264	
Tightening torque range	Nm	0.5...0.6	
Rated current, max.	A	41	41
At ambient temperature		20°C	40°C
For conductor cross-section	mm ²	6	
Overvoltage category		III	III II
Pollution severity		3	2 2
Rated voltage	V	800	1000 1000
Rated impulse voltage	kV	8	8 6
UL / CUL (Use Group)		B	C D
Rated voltage	V	600	600 600
Rated current	A	35	35 5
AWG conductor	AWG	24-10	
CSA (Use Group)		B	C D
Rated voltage	V	600	600 600
Rated current	A	35	35 5
AWG conductor	AWG	24-10	
General data			
Type of insulation material		PA GF	
UL 94 flammability rating		V-0	
Contact base material		Copper alloy	
Material of contact surface		tinned	
Pin dimensions = d	mm		
Solder eyelet Ø = D	mm		
Solder eyelet Ø tolerance	mm		

Accessories

Note: Refer to the Accessories chapter for additional accessories.

Coding		Order No.
	BV/SV 7.62HP K0	1937590000
Strain relief		
	BV/SV 7.62HP/02 ZE GR	1937550000
	BV/SV 7.62HP/04 ZE GR	1937560000
Screwdriver		
	SDS 0.8x4.0x125	9009020000
Crosshead screwdriver		
	SDK PH1	9008480000

Ordering data

Solder pin length					
Colour					Black
Pitch 7.62 mm					
Pol.	L1	(inch)	Qty.	Order No.	
2	7.62	0.300	100	1931620000	
3	15.24	0.600	100	1931630000	
4	22.86	0.900	100	1931640000	
5	30.48	1.200	50	1931660000	
6	38.10	1.500	50	1931670000	
7	45.72	1.800	50	1931680000	

Representative deratings curve

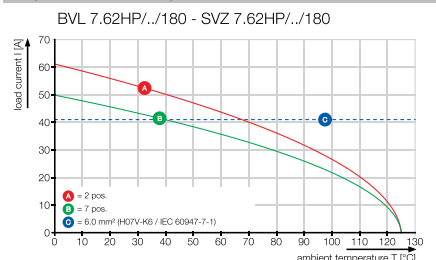

SVZ 7.62HP../180F



SVZ 7.62HP../180SF



Dimensioned drawing

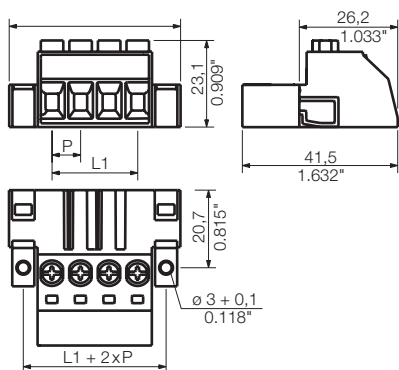

Dimensioned drawing

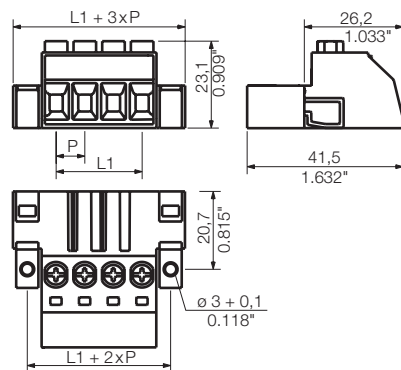

Ordering data

Solder pin length					
Colour					Black
Pitch 7.62 mm					
Pol.	L1	(inch)	Qty.	Order No.	
2	7.62	0.300	100	1931740000	
3	15.24	0.600	100	1931760000	
4	22.86	0.900	100	1931820000	
5	30.48	1.200	50	1931840000	
6	38.10	1.500	50	1931850000	
7	45.72	1.800	50	1931860000	

Ordering data

Solder pin length					
Colour					Black
Pitch 7.62 mm					
Pol.	L1	(inch)	Qty.	Order No.	
2	7.62	0.300	100	1931960000	
3	15.24	0.600	100	1931970000	
4	22.86	0.900	100	1931980000	
5	30.48	1.200	50	1931990000	
6	38.10	1.500	50	1932000000	
7	45.72	1.800	50	1932010000	

Additional deratings curves

BVZ 7.62HP../180 - SVZ 7.62HP../180

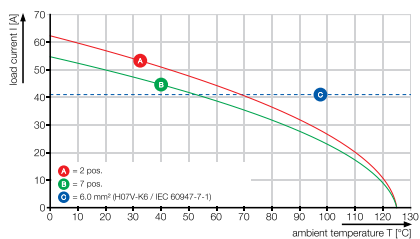

Connectors in 7.62 mm pitch
Series BV/SV 7.62 – connects up to 6 mm²

SVZ 7.62HP../180FC

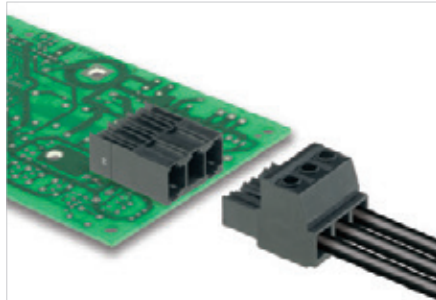

Male plug in 180° outlet direction with clamping yoke screw connection for TNC (S) systems. Also perfect for finger-safe solutions involving inverse voltages. Meets the requirements of UL1059 for 600 V Use Group C. The mating profile ensures touch-safety of > 3 mm in accordance with IEC 61800-5-1.

Maximum operational reliability: with a derating up to 125 °C, a mating profile that can only be plugged in correct, and unique coding capability.

- Available with a flange (FL) and a screw flange (SFC).

Product data

IEC: 1000 V / 41 A / 0.2 - 6 mm²
 UL: 600 V / 35 A / AWG 24 - 10

For additional articles and information, refer to catalog.weidmueller.com

Note:

- Additional colours on request
- Rated current related to rated cross-section & min. No. of poles.
- Wire end ferrule without plastic collar to DIN 46228/1
- Wire end ferrule with plastic collar to DIN 46228/4
- P on drawing = pitch
- Rated data refer only to the component itself. Clearance and creepage distances to other components are to be designed in accordance with the relevant application standards.

SVZ 7.62HP../180FC



Dimensioned drawing

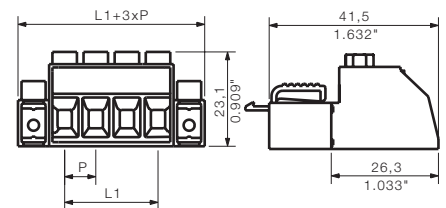

Technical data

In compliance with IEC 60664-1 / IEC 61984			
Clamping range, max.	mm ²	0.2...6	
Solid core H05(07) V-U	mm²	0.2...6	
Stranded H07 V-R			
Flexible H05(07) V-K	mm ²	0.5...6	
Flexible with ferrule	mm ²	0.25...6	
Ferrule with plastic collar	mm ²	0.25...6	
Stripping length	mm	12	
Screwdriver blade	mm	0.8 x 4.5	
According to norm		DIN 5264	
Tightening torque range	Nm	0.5...0.6	
Rated current, max.	A	41	41
At ambient temperature		20°C	40°C
For conductor cross-section	mm ²	6	
Overvoltage category		III	III II
Pollution severity		3	2 2
Rated voltage	V	800	1000 1000
Rated impulse voltage	kV	8	8 6
UL / CUL (Use Group)		B	C D
Rated voltage	V	600	600 600
Rated current	A	35	35 5
AWG conductor	AWG	24-10	
CSA (Use Group)		B	C D
Rated voltage	V	600	600 600
Rated current	A	35	35 5
AWG conductor	AWG	24-10	
General data			
Type of insulation material		PA GF	
UL 94 flammability rating		V-0	
Contact base material		Copper alloy	
Material of contact surface		tinned	
Pin dimensions = d	mm		
Solder eyelet Ø = D	mm		
Solder eyelet Ø tolerance	mm		

Accessories

Note: Refer to the Accessories chapter for additional accessories.

Coding		Order No.
	BV/SV 7.62HP K0	1937590000
Strain relief		
	BV/SV 7.62HP/02 ZE GR	1937550000
	BV/SV 7.62HP/04 ZE GR	1937560000
Screwdriver		
	SDS 0.8x4.0x125	9009020000
Crosshead screwdriver		
	SDK PH1	9008480000

Ordering data

Solder pin length					
Colour	Black				
Pitch	7.62 mm				
Pol.	L1	(inch)	Qty.	Order No.	
2	7.62	0.300	100	1950880000	
3	15.24	0.600	100	1950890000	
4	22.86	0.900	100	1950900000	
5	30.48	1.200	50	1950910000	
6	38.10	1.500	50	1950920000	
7	45.72	1.800	50	1950930000	

Representative deratings curve

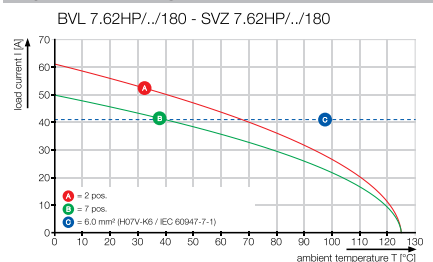

SVZ 7.62HP../180SFC



Dimensioned drawing

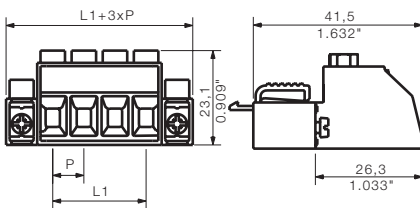

Ordering data

Solder pin length				
Colour				Black
Pitch		7.62 mm		
Pol.	L1	(inch)	Qty.	Order No.
2	7.62	0.300	100	1950990000
3	15.24	0.600	100	1951000000
4	22.86	0.900	100	1951010000
5	30.48	1.200	50	1951020000
6	38.10	1.500	50	1951030000
7	45.72	1.800	50	1951050000

Additional deratings curves

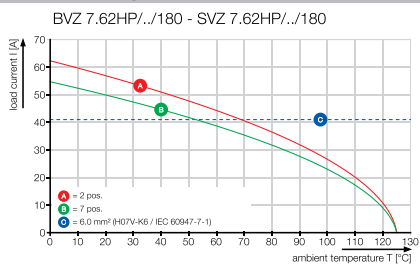

Connectors in 7.62 mm pitch
Series BV/SV 7.62 – connects up to 6 mm²

SVZ 7.62HP../180FI

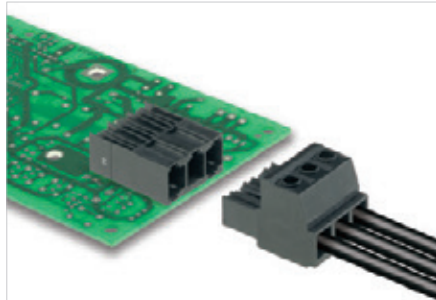

Male plug in 180° outlet direction with clamping yoke screw connection for TNC (S) systems. Also perfect for finger-safe solutions involving inverse voltages for board-to-wire connections. Meets the requirements of UL1059 for 600 V Use Group C. The mating profile ensures touch-safety of > 3 mm in accordance with IEC 61800-5-1.

Maximum operational reliability: with a derating up to 125 °C, a mating profile that can only be plugged in correct, and unique coding capability.

Variants: flange and screw flange mountings.

- Available with a flange (FI) and a screw flange (SFI).

Product data

IEC: 1000 V / 41 A / 0.2 - 6 mm²
 UL: 600 V / 35 A / AWG 24 - 10

For additional articles and information, refer to catalog.weidmueller.com

Note:

- Additional colours on request
- Rated current related to rated cross-section & min. No. of poles.
- Wire end ferrule without plastic collar to DIN 46228/1
- Wire end ferrule with plastic collar to DIN 46228/4
- P on drawing = pitch
- Rated data refer only to the component itself. Clearance and creepage distances to other components are to be designed in accordance with the relevant application standards.

SVZ 7.62HP../180FI



Dimensioned drawing

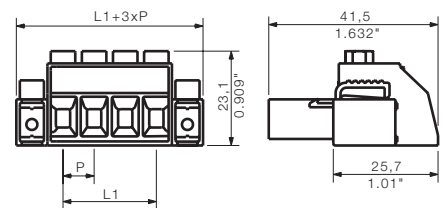

Technical data

In compliance with IEC 60664-1 / IEC 61984			
Clamping range, max.	mm ²	0.2...6	
Solid core H05(07) V-U	mm²	0.2...6	
Stranded H07 V-R			
Flexible H05(07) V-K	mm ²	0.5...6	
Flexible with ferrule	mm ²	0.25...6	
Ferrule with plastic collar	mm ²	0.25...6	
Stripping length	mm	12	
Screwdriver blade	mm	0.8 x 4.5	
According to norm		DIN 5264	
Tightening torque range	Nm	0.5...0.6	
Rated current, max.	A	41	41
At ambient temperature		20°C	40°C
For conductor cross-section	mm ²	6	
Overvoltage category		III	III II
Pollution severity		3	2 2
Rated voltage	V	800	1000 1000
Rated impulse voltage	kV	8	8 6
UL / CUL (Use Group)		B	C D
Rated voltage	V	600	600 600
Rated current	A	35	35 5
AWG conductor	AWG	24-10	
CSA (Use Group)		B	C D
Rated voltage	V	600	600 600
Rated current	A	35	35 5
AWG conductor	AWG	24-10	
General data			
Type of insulation material		PA GF	
UL 94 flammability rating		V-0	
Contact base material		Copper alloy	
Material of contact surface		tinned	
Pin dimensions = d	mm		
Solder eyelet Ø = D	mm		
Solder eyelet Ø tolerance	mm		

Accessories

Note: Refer to the Accessories chapter for additional accessories.

Coding		Order No.
	BV/SV 7.62HP K0	1937590000
Strain relief		
	BV/SV 7.62HP/02 ZE GR	1937560000
	BV/SV 7.62HP/04 ZE GR	1937560000
Screwdriver		
	SDS 0.8x4.0x125	9009020000
Crosshead screwdriver		
	SDK PH1	9008480000

Ordering data

Solder pin length					
Colour					Black
Pitch 7.62 mm					
Pol.	L1	(inch)	Qty.	Order No.	
2	7.62	0.300	100	1932070000	
3	15.24	0.600	100	1932080000	
4	22.86	0.900	100	1932090000	
5	30.48	1.200	50	1932100000	
6	38.10	1.500	50	1932110000	
7	45.72	1.800	50	1932120000	

Representative deratings curve

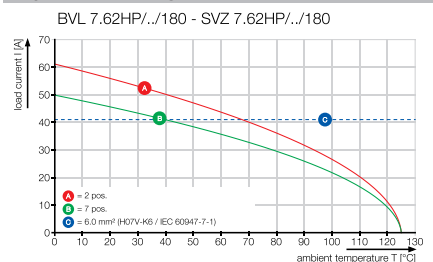

SVZ 7.62HP../180SFI



Dimensioned drawing

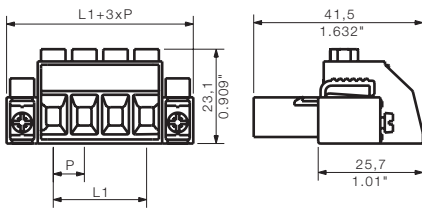

Ordering data

Solder pin length				
Colour				Black
Pitch		7.62 mm		
Pol.	L1	(inch)	Qty.	Order No.
2	7.62	0.300	100	1932180000
3	15.24	0.600	100	1932190000
4	22.86	0.900	100	1932200000
5	30.48	1.200	50	1932210000
6	38.10	1.500	50	1932220000
7	45.72	1.800	50	1932230000

Additional deratings curves

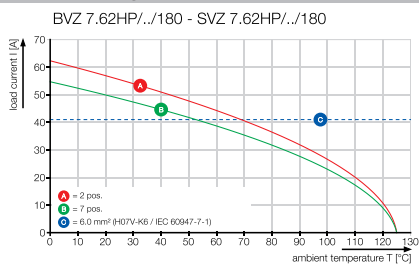

Connectors in 7.62 mm pitch
Series BV/SV 7.62 – connects up to 6 mm²

SVZ 7.62HP../180SH

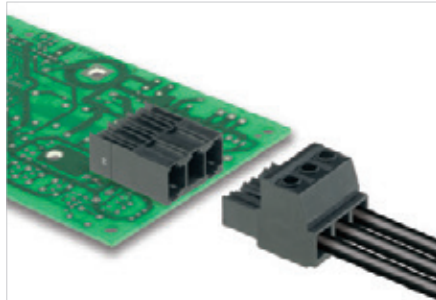

Male plug in 180° outlet direction with clamping yoke screw connection and additional shield connection for TNC (S) systems. Also perfect for finger-safe solutions involving inverse voltages. Meets the requirements of UL1059 for 600 V Use Group C. The mating profile ensures touch-safety of > 3 mm in accordance with IEC 61800-5-1.

Maximum operational reliability with a derating up to 125 °C, a mating profile that can only be plugged in correct, and unique coding capability.

- Available with shield in three different orientations.

Product data

IEC: 1000 V / 41 A / 0.2 - 6 mm²
 UL: 600 V / 35 A / AWG 24 - 10

For additional articles and information, refer to catalog.weidmueller.com

Note:

- Additional colours on request
- Rated current related to rated cross-section & min. No. of poles.
- Wire end ferrule without plastic collar to DIN 46228/1
- Wire end ferrule with plastic collar to DIN 46228/4
- P on drawing = pitch
- Rated data refer only to the component itself. Clearance and creepage distances to other components are to be designed in accordance with the relevant application standards.

SVZ 7.62HP../180SH180



Dimensioned drawing

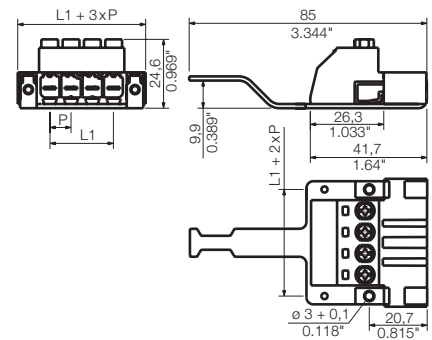

Technical data

In compliance with IEC 60664-1 / IEC 61984			
Clamping range, max.	mm ²	0.2...6	
Solid core H05(07) V-U	mm²	0.2...6	
Stranded H07 V-R			
Flexible H05(07) V-K	mm ²	0.5...6	
Flexible with ferrule	mm ²	0.25...6	
Ferrule with plastic collar	mm ²	0.25...6	
Stripping length	mm	12	
Screwdriver blade	mm	0.8 x 4.5	
According to norm		DIN 5264	
Tightening torque range	Nm	0.5...0.6	
Rated current, max.	A	41	41
At ambient temperature		20°C	40°C
For conductor cross-section	mm ²	6	
Overvoltage category		III	III II
Pollution severity		3	2 2
Rated voltage	V	800	1000 1000
Rated impulse voltage	kV	8	8 6
UL / CUL (Use Group)		B	C D
Rated voltage	V	600	600 600
Rated current	A	35	35 5
AWG conductor	AWG	24-10	
CSA (Use Group)		B	C D
Rated voltage	V	600	600 600
Rated current	A	35	35 5
AWG conductor	AWG	24-10	
General data			
Type of insulation material		PA GF	
UL 94 flammability rating		V-0	
Contact base material		Copper alloy	
Material of contact surface		tinned	
Pin dimensions = d	mm		
Solder eyelet Ø = D	mm		
Solder eyelet Ø tolerance	mm		

Accessories

Note: Refer to the Accessories chapter for additional accessories.

Coding		Order No.
	BV/SV 7.62HP K0	1937590000
Screwdriver		
	SDS 0.8x4.0x125	9009020000
Crosshead screwdriver		
	SDK PH1	9008480000

Ordering data

Solder pin length				
Colour	Black			
Pitch	7.62 mm			
Pol.	L1	(inch)	Qty.	Order No.
3	15.24	0.600	50	1932460000
4	22.86	0.900	25	1932470000
5	30.48	1.200	25	1932480000
6	38.10	1.500	25	1932490000

Representative deratings curve

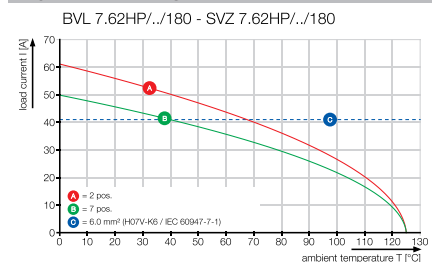

Connectors in 7.62 mm pitch
Series BV/SV 7.62 – connects up to 6 mm²

SVZ 7.62HP../180SH C

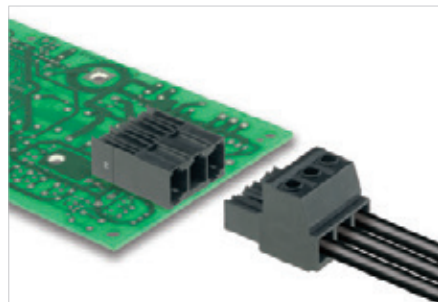

Female plug in 180° outlet direction with clamping yoke screw connection and additional shield connection for TNC (S) systems. Also perfect for finger-safe solutions involving inverse voltages. Meets the requirements of UL1059 for 600 V Use Group C. The mating profile ensures touch-safety of > 3 mm in accordance with IEC 61800-5-1.

Maximum operational reliability with a derating up to 125 °C, a mating profile that can only be plugged in correct, and unique coding capability.

- Available with shield in three different orientations.

Product data

IEC: 1000 V / 41 A / 0.2 - 6 mm²
 UL: 600 V / 35 A / AWG 24 - 10

For additional articles and information, refer to catalog.weidmueller.com

Note:

- Additional colours on request
- Rated current related to rated cross-section & min. No. of poles.
- Wire end ferrule without plastic collar to DIN 46228/1
- Wire end ferrule with plastic collar to DIN 46228/4
- P on drawing = pitch
- Rated data refer only to the component itself. Clearance and creepage distances to other components are to be designed in accordance with the relevant application standards.

SVZ 7.62HP../180SH180C



Dimensioned drawing

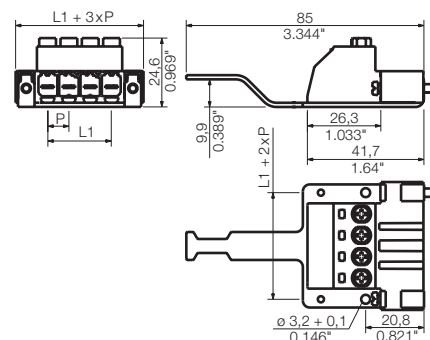

Technical data

In compliance with IEC 60664-1 / IEC 61984			
Clamping range, max.	mm ²	0.2...6	
Solid core H05(07) V-U	mm²	0.2...6	
Stranded H07 V-R			
Flexible H05(07) V-K	mm ²	0.5...6	
Flexible with ferrule	mm ²	0.25...6	
Ferrule with plastic collar	mm ²	0.25...6	
Stripping length	mm	12	
Screwdriver blade	mm	0.8 x 4.5	
According to norm		DIN 5264	
Tightening torque range	Nm	0.5...0.6	
Rated current, max.	A	41	41
At ambient temperature		20°C	40°C
For conductor cross-section	mm ²	6	
Overvoltage category		III	III II
Pollution severity		3	2 2
Rated voltage	V	800	1000 1000
Rated impulse voltage	kV	8	8 6
UL / CUL (Use Group)		B	C D
Rated voltage	V	600	600 600
Rated current	A	35	35 5
AWG conductor	AWG	24-10	
CSA (Use Group)		B	C D
Rated voltage	V	600	600 600
Rated current	A	35	35 5
AWG conductor	AWG	24-10	
General data			
Type of insulation material		PA GF	
UL 94 flammability rating		V-0	
Contact base material		Copper alloy	
Material of contact surface		tinned	
Pin dimensions = d	mm		
Solder eyelet Ø = D	mm		
Solder eyelet Ø tolerance	mm		

Accessories

Note: Refer to the Accessories chapter for additional accessories.

Coding		Order No.
	BV/SV 7.62HP K0	1937590000
Screwdriver		
	SDS 0.8x4.0x125	9009020000
Crosshead screwdriver		
	SDK PH1	9008480000

Ordering data

Solder pin length				
Colour	Black			
Pitch	7.62 mm			
Pol.	L1	(inch)	Qty.	Order No.
3	15.24	0.600	50	1951150000
4	22.86	0.900	25	1951160000
5	30.48	1.200	25	1951170000
6	38.10	1.500	25	1951180000

Representative deratings curve

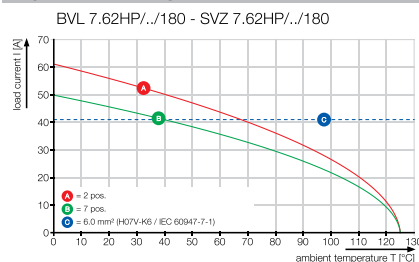

Connectors in 7.62 mm pitch
Series BV/SV 7.62 – connects up to 6 mm²

SVZ 7.62HP../180SH I

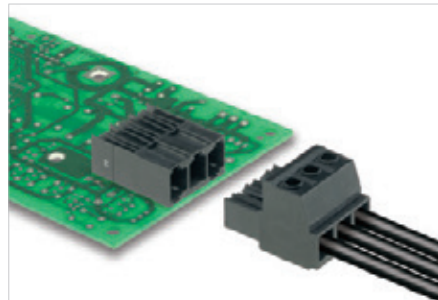

Male plug in 180° outlet direction with clamping yoke screw connection and additional shield connection for TNC (S) systems. Also perfect for finger-safe solutions involving inverse voltages for board-to-wire connections. Meets the requirements of UL1059 for 600 V Use Group C. The mating profile ensures touch-safety of > 3 mm in accordance with IEC 61800-5-1.

Maximum operational reliability with a derating up to 125 °C, a mating profile that can only be plugged in correct, and unique coding capability.

- Available with shield in three different orientations.

Product data

IEC: 1000 V / 41 A / 0.2 - 6 mm²
 UL: 600 V / 35 A / AWG 24 - 10

For additional articles and information, refer to catalog.weidmueller.com

Note:

- Additional colours on request
- Rated current related to rated cross-section & min. No. of poles.
- Wire end ferrule without plastic collar to DIN 46228/1
- Wire end ferrule with plastic collar to DIN 46228/4
- P on drawing = pitch
- Rated data refer only to the component itself. Clearance and creepage distances to other components are to be designed in accordance with the relevant application standards.

SVZ 7.62HP../180SH150I



Dimensioned drawing

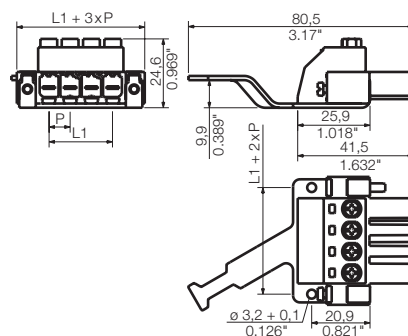

Technical data

In compliance with IEC 60664-1 / IEC 61984			
Clamping range, max.	mm ²	0.2...6	
Solid core H05(07) V-U	mm²	0.2...6	
Stranded H07 V-R			
Flexible H05(07) V-K	mm ²	0.5...6	
Flexible with ferrule	mm ²	0.25...6	
Ferrule with plastic collar	mm ²	0.25...6	
Stripping length	mm	12	
Screwdriver blade	mm	0.8 x 4.5	
According to norm		DIN 5264	
Tightening torque range	Nm	0.5...0.6	
Rated current, max.	A	41	41
At ambient temperature		20°C	40°C
For conductor cross-section	mm ²	6	
Overvoltage category		III	III II
Pollution severity		3	2 2
Rated voltage	V	800	1000 1000
Rated impulse voltage	kV	8	8 6
UL / CUL (Use Group)		B	C D
Rated voltage	V	600	600 600
Rated current	A	35	35 5
AWG conductor	AWG	24-10	
CSA (Use Group)		B	C D
Rated voltage	V	600	600 600
Rated current	A	35	35 5
AWG conductor	AWG	24-10	
General data			
Type of insulation material		PA GF	
UL 94 flammability rating		V-0	
Contact base material		Copper alloy	
Material of contact surface		tinned	
Pin dimensions = d	mm		
Solder eyelet Ø = D	mm		
Solder eyelet Ø tolerance	mm		

Accessories

Note: Refer to the Accessories chapter for additional accessories.

Coding	Order No.
BV/SV 7.62HP K0	1937590000
Screwdriver	
SDS 0.8x4.0x125	9009020000
Crosshead screwdriver	
SDK PH1	9008480000

Ordering data

Solder pin length				
Colour	Black			
Pitch	7.62 mm			
Pol.	L1	(inch)	Qty.	Order No.
3	15.24	0.600	50	1932330000
4	22.86	0.900	25	1932340000
5	30.48	1.200	25	1932350000
6	38.10	1.500	25	1932360000

Representative deratings curve

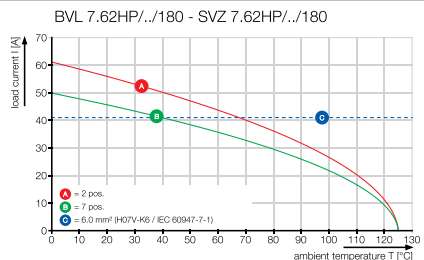

SVZ 7.62HP../180SH180I



SVZ 7.62HP../180SH210I



Dimensioned drawing

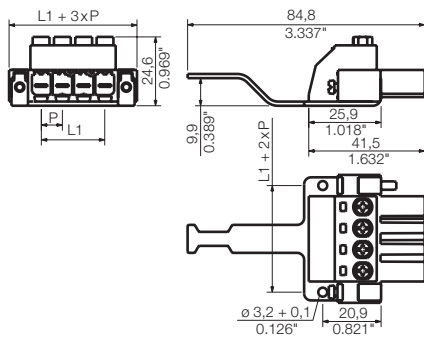

Dimensioned drawing

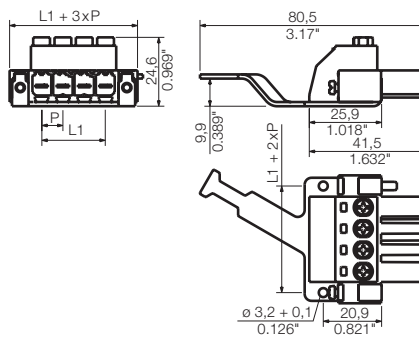

Ordering data

Solder pin length					
Colour					Black
Pitch 7.62 mm					
Pol.	L1	(inch)	Qty.	Order No.	
3	15.24	0.600	50	1932500000	
4	22.86	0.900	25	1932510000	
5	30.48	1.200	25	1932520000	
6	38.10	1.500	25	1932530000	

Ordering data

Solder pin length					
Colour					Black
Pitch 7.62 mm					
Pol.	L1	(inch)	Qty.	Order No.	
3	15.24	0.600	50	1932580000	
4	22.86	0.900	25	1932590000	
5	30.48	1.200	25	1932600000	
6	38.10	1.500	25	1932610000	

Additional deratings curves

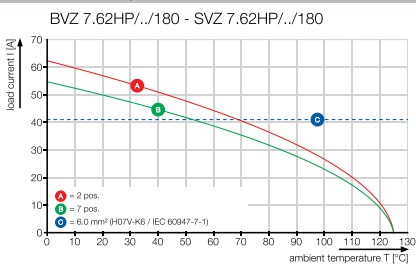

Connectors in 7.62 mm pitch
Series BV/SV 7.62 – connects up to 6 mm²

SVF 7.62HP../180

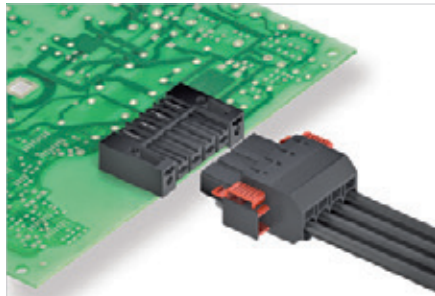

Male plug in 180° outlet direction and PUSH IN spring connection for TNC(S) networks. Also perfect for finger-safe solutions involving inverse voltages. Meets the requirements of UL1059 for 600 V Use Group C. The mating profile ensures touch-safety of > 3 mm in accordance with IEC 61800-5-1.

Maximum operational reliability: with a derating up to 125 °C, a mating profile that can only be plugged in correct, and unique coding capability.

- Available with a flange (F) and a screw flange (SF).

Product data

IEC: 1000 V / 41 A / 0.5 - 10 mm²
 UL: 600 V / 35 A / AWG 24 - 10

For additional articles and information, refer to catalog.weidmueller.com

Note:

- Additional colours on request
- Rated current related to rated cross-section & min. No. of poles.
- Wire end ferrule without plastic collar to DIN 46228/1
- Wire end ferrule with plastic collar to DIN 46228/4
- P on drawing = pitch
- Rated data refer only to the component itself. Clearance and creepage distances to other components are to be designed in accordance with the relevant application standards.

SVF 7.62HP../180G



Dimensioned drawing

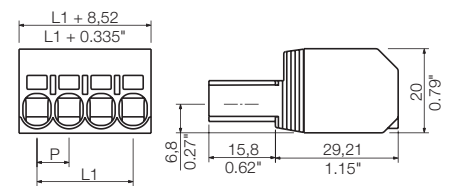

Technical data

In compliance with IEC 60664-1 / IEC 61984			
Clamping range, max.	mm ²	0.5...10	
Solid core H05(07) V-U	mm²	0.5...10	
Stranded H07 V-R		...10	
Flexible H05(07) V-K	mm ²	0.5...	
Flexible with ferrule	mm ²	1.5...4	
Ferrule with plastic collar	mm ²	1.5...6	
Stripping length	mm	12	
Screwdriver blade	mm	0.8 x 4.5	
According to norm		DIN 5264	
Tightening torque range	Nm		
Rated current, max.	A	41	41
At ambient temperature		20°C	40°C
For conductor cross-section	mm ²	6	
Overvoltage category		III	III II
Pollution severity		3	2 2
Rated voltage	V	800	1000 1000
Rated impulse voltage	kV	8	8 6
UL / CUL (Use Group)		B	C D
Rated voltage	V	600	600 600
Rated current	A	35	35 5
AWG conductor	AWG	24-10	
CSA (Use Group)		B	C D
Rated voltage	V	600	600 600
Rated current	A	35	35 5
AWG conductor	AWG	24-10	
General data			
Type of insulation material		PA GF	
UL 94 flammability rating		V-0	
Contact base material		Copper alloy	
Material of contact surface		tinned	
Pin dimensions = d	mm		
Solder eyelet Ø = D	mm		
Solder eyelet Ø tolerance	mm		

Accessories

Note: Refer to the Accessories chapter for additional accessories.

Coding		Order No.
	BV/SV 7.62HP K0	1937590000
Screwdriver		
	SDS 0.8x4.0x125	9009020000
Crimping tool		
	PZ 6/5	9011460000

Ordering data

Solder pin length					
Colour					Black
Pitch 7.62 mm					
Pol.	L1	(inch)	Qty.	Order No.	
2	7.62	0.300	95	1060830000	
3	15.24	0.600	65	1060840000	
4	22.86	0.900	45	1060850000	
5	30.48	1.200	40	1060870000	
6	38.10	1.500	30	1060880000	

Representative deratings curve

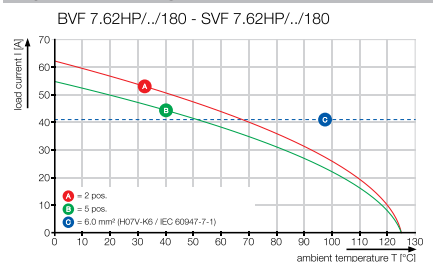

SVF 7.62HP../180F



SVF 7.62HP../180SF



Dimensioned drawing

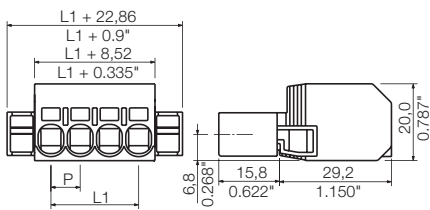

Dimensioned drawing

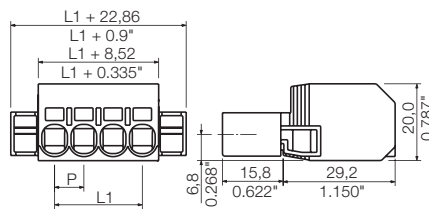

Ordering data

Solder pin length					
Colour					Black
Pitch 7.62 mm					
Pol.	L1	(inch)	Qty.	Order No.	
2	7.62	0.300	50	1060900000	
3	15.24	0.600	40	1060910000	
4	22.86	0.900	30	1060920000	
5	30.48	1.200	25	1060930000	

Ordering data

Solder pin length					
Colour					Black
Pitch 7.62 mm					
Pol.	L1	(inch)	Qty.	Order No.	
2	7.62	0.300	50	1060950000	
3	15.24	0.600	40	1060970000	
4	22.86	0.900	30	1060980000	
5	30.48	1.200	25	1061000000	

Connectors in 7.62 mm pitch
Series BV/SV 7.62 – connects up to 6 mm²

SVF 7.62HP../180 I

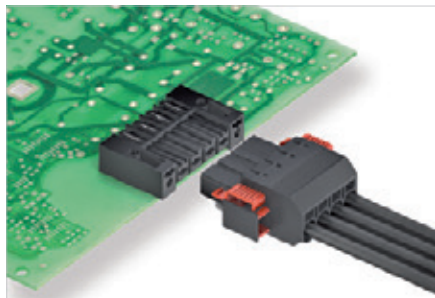

Male plug in 180° outlet direction and PUSH IN spring connection for TNC(S) networks. Also perfect for finger-safe solutions involving inverse voltages for board-to-board connections. Meets the requirements of UL1059 for 600 V Use Group C. The mating profile ensures touch-safety of > 3 mm in accordance with IEC 61800-5-1.

Maximum operational reliability with a derating up to 125 °C, a mating profile that can only be plugged in correct, and unique coding capability.

- Available with a flange (F) and a screw flange (SFI).

Product data

IEC: 1000 V / 41 A / 0.5 - 10 mm²
 UL: 600 V / 35 A / AWG 24 - 10

For additional articles and information, refer to catalog.weidmueller.com

Note:

- Additional colours on request
- Rated current related to rated cross-section & min. No. of poles.
- Wire end ferrule without plastic collar to DIN 46228/1
- Wire end ferrule with plastic collar to DIN 46228/4
- P on drawing = pitch
- Rated data refer only to the component itself. Clearance and creepage distances to other components are to be designed in accordance with the relevant application standards.

SVF 7.62HP../180FI



Dimensioned drawing

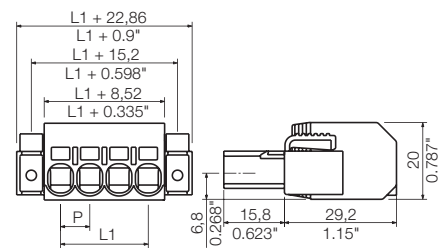

Technical data

In compliance with IEC 60664-1 / IEC 61984			
Clamping range, max.	mm ²	0.5...10	
Solid core H05(07) V-U	mm²	0.5...10	
Stranded H07 V-R		...10	
Flexible H05(07) V-K	mm ²	0.5...	
Flexible with ferrule	mm ²	1.5...4	
Ferrule with plastic collar	mm ²	1.5...6	
Stripping length	mm	12	
Screwdriver blade	mm	0.8 x 4.5	
According to norm		DIN 5264	
Tightening torque range	Nm		
Rated current, max.	A	41	41
At ambient temperature		20°C	40°C
For conductor cross-section	mm ²	6	
Overvoltage category		III	III II
Pollution severity		3	2 2
Rated voltage	V	800	1000 1000
Rated impulse voltage	kV	8	8 6
UL / CUL (Use Group)		B	C D
Rated voltage	V	600	600 600
Rated current	A	35	35 5
AWG conductor	AWG	24-10	
CSA (Use Group)		B	C D
Rated voltage	V	600	600 600
Rated current	A	35	35 5
AWG conductor	AWG	24-10	
General data			
Type of insulation material		PA GF	
UL 94 flammability rating		V-0	
Contact base material		Copper alloy	
Material of contact surface		tinned	
Pin dimensions = d	mm		
Solder eyelet Ø = D	mm		
Solder eyelet Ø tolerance	mm		

Accessories

Note: Refer to the Accessories chapter for additional accessories.

Coding		Order No.
	BV/SV 7.62HP K0	1937590000
Screwdriver		
	SDS 0.8x4.0x125	9009020000
Crimping tool		
	PZ 6/5	9011460000

Ordering data

Solder pin length				
Colour	Black			
Pitch	7.62 mm			
Pol.	L1	(inch)	Qty.	Order No.
2	7.62	0.300	50	1124750000
3	15.24	0.600	40	1124760000
4	22.86	0.900	30	1124770000
5	30.48	1.200	25	1124780000

Representative deratings curve

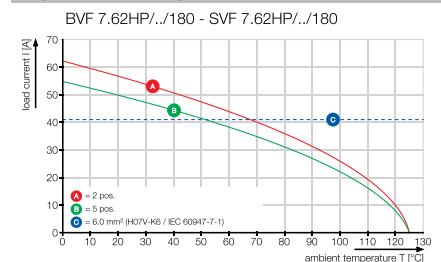

SVF 7.62HP/./180SFI



Dimensioned drawing

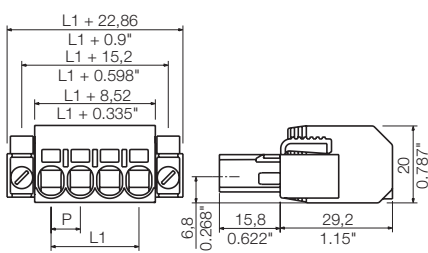

Ordering data

Solder pin length				
Colour				Black
Pitch		7.62 mm		
Pol.	L1	(inch)	Qty.	Order No.
2	7.62	0.300	50	1124810000
3	15.24	0.600	40	1124820000
4	22.86	0.900	30	1124830000
5	30.48	1.200	25	1124840000

Connectors in 7.62 mm pitch
Series BV/SV 7.62 – connects up to 6 mm²

SVF 7.62HP../180MF

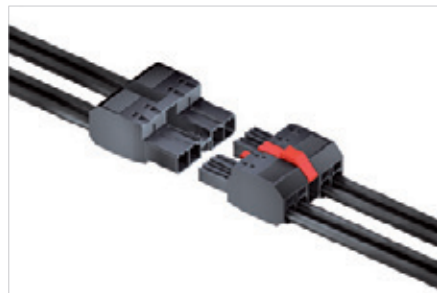

Male plug in 180° outlet direction with PUSH IN spring connection for TNC(S) networks. Also perfect for finger-safe solutions involving inverse voltages. Meets the requirements of UL1059 for 600 V Use Group C. The mating profile ensures touch-safety of > 3 mm in accordance with IEC 61800-5-1.

Maximum operational reliability with a derating up to 125 °C, a mating profile that can only be plugged in correct, and unique coding capability.

- Middle flange is available in positions 2, 3 and 4.

Product data

IEC: 1000 V / 41 A / 0.5 - 10 mm²
 UL: 600 V / 35 A / AWG 24 - 10

For additional articles and information, refer to catalog.weidmueller.com

Note:

- Additional colours on request
- Rated current related to rated cross-section & min. No. of poles.
- Wire end ferrule without plastic collar to DIN 46228/1
- Wire end ferrule with plastic collar to DIN 46228/4
- P on drawing = pitch
- Rated data refer only to the component itself. Clearance and creepage distances to other components are to be designed in accordance with the relevant application standards.

SVF 7.62HP../180MF2

Dimensioned drawing

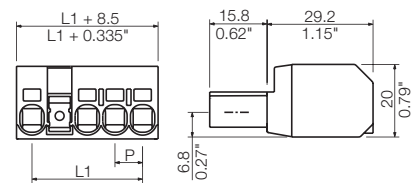

Technical data

In compliance with IEC 60664-1 / IEC 61984

Clamping range, max.	mm ²	0.5...10
Solid core H05(07) V-U	mm²	0.5...10
Stranded H07 V-R		...10
Flexible H05(07) V-K	mm ²	0.5...
Flexible with ferrule	mm ²	1.5...4
Ferrule with plastic collar	mm ²	1.5...6
Stripping length	mm	12
Screwdriver blade	mm	0.8 x 4.5
According to norm		DIN 5264

Tightening torque range	Nm	
Rated current, max.	A	41
At ambient temperature		20°C 40°C
For conductor cross-section	mm ²	6
Overvoltage category		III III II
Pollution severity		3 2 2

Rated voltage	V	800	1000	1000
Rated impulse voltage	kV	8	8	6

UL / CUL (Use Group)

Rated voltage	V	600	600	600
Rated current	A	35	35	5
AWG conductor	AWG	24-10		

CSA (Use Group)

Rated voltage	V	600	600	600
Rated current	A	35	35	5
AWG conductor	AWG	24-10		

General data

Type of insulation material		PA GF
UL 94 flammability rating		V-0
Contact base material		Copper alloy
Material of contact surface		tinned
Pin dimensions = d	mm	
Solder eyelet Ø = D	mm	
Solder eyelet Ø tolerance	mm	

Accessories

Note: Refer to the Accessories chapter for additional accessories.

Coding		Order No.
	BV/SV 7.62HP K0	1937590000
Screwdriver		
	SDS 0.8x4.0x125	9009020000
Crimping tool		
	PZ 6/5	9011460000

Ordering data

Solder pin length				
Colour	Black			
Pitch	7.62 mm			
Pol.	L1	(inch)	Qty.	Order No.
2	7.62	0.300	65	1061020000
3	15.24	0.600	50	1061030000

Representative deratings curve

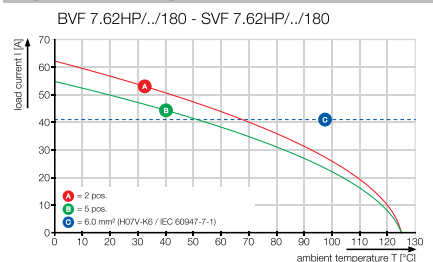

SVF 7.62HP../180MF3



Dimensioned drawing

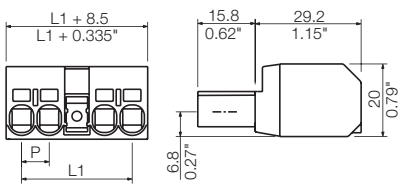

SVF 7.62HP../180MF4

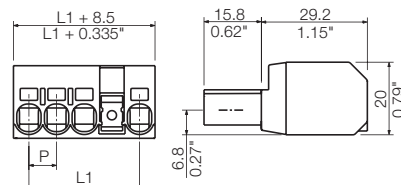

Dimensioned drawing

Ordering data

Solder pin length					
Colour					Black
Pitch 7.62 mm					
Pol.	L1	(inch)	Qty.	Order No.	
3	15.24	0.600	50	1061040000	
4	22.86	0.900	40	1061050000	
5	30.48	1.200	30	1061070000	

Ordering data

Solder pin length					
Colour					Black
Pitch 7.62 mm					
Pol.	L1	(inch)	Qty.	Order No.	
5	30.48	1.200	30	1061080000	

Connectors in 7.62 mm pitch
Series BV/SV 7.62 – connects up to 6 mm²

SVF 7.62HP../180MSF



Male plug in 180° outlet direction with PUSH IN spring connection for TNC(S) networks. Also perfect for finger-safe solutions involving inverse voltages. Meets the requirements of UL1059 for 600 V Use Group C. The mating profile ensures touch-safety of > 3 mm in accordance with IEC 61800-5-1.

Maximum operational reliability: with a derating up to 125 °C, a mating profile that can only be plugged in correct, and unique coding capability.

- Middle flange is available in positions 2, 3 and 4.

Product data

IEC: 1000 V / 41 A / 0.5 - 10 mm²
 UL: 600 V / 35 A / AWG 24 - 10

For additional articles and information, refer to catalog.weidmueller.com

Note:

- Additional colours on request
- Rated current related to rated cross-section & min. No. of poles.
- Wire end ferrule without plastic collar to DIN 46228/1
- Wire end ferrule with plastic collar to DIN 46228/4
- P on drawing = pitch
- Rated data refer only to the component itself. Clearance and creepage distances to other components are to be designed in accordance with the relevant application standards.

SVF 7.62HP../180MSF2

Dimensioned drawing

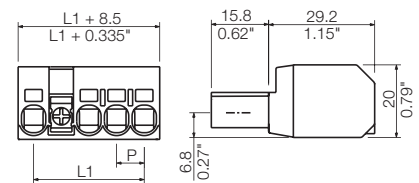

Technical data

In compliance with IEC 60664-1 / IEC 61984

Clamping range, max.	mm ²	0.5...10
Solid core H05(07) V-U	mm²	0.5...10
Stranded H07 V-R		...10
Flexible H05(07) V-K	mm ²	0.5...
Flexible with ferrule	mm ²	1.5...4
Ferrule with plastic collar	mm ²	1.5...6
Stripping length	mm	12
Screwdriver blade	mm	0.8 x 4.5
According to norm		DIN 5264

Tightening torque range	Nm	
Rated current, max.	A	41
At ambient temperature		20°C 40°C
For conductor cross-section	mm ²	6
Overvoltage category		III III II
Pollution severity		3 2 2

Rated voltage	V	800	1000	1000
Rated impulse voltage	kV	8	8	6
UL / CUL (Use Group)	B	C	D	

Rated voltage	V	600	600	600
Rated current	A	35	35	5
AWG conductor	AWG	24-10		
CSA (Use Group)	B	C	D	
Rated voltage	V	600	600	600
Rated current	A	35	35	5
AWG conductor	AWG	24-10		

General data

Type of insulation material		PA GF
UL 94 flammability rating		V-0
Contact base material		Copper alloy
Material of contact surface		tinned
Pin dimensions = d	mm	
Solder eyelet Ø = D	mm	
Solder eyelet Ø tolerance	mm	

Accessories

Note: Refer to the Accessories chapter for additional accessories.

Coding		Order No.
	BV/SV 7.62HP K0	1937590000
Screwdriver		
	SDIS 0.6X3.5X100	9008390000
	SDS 0.6X3.5X100	9008330000
Crimping tool		
	PZ 6/5	9011460000

Ordering data

Solder pin length				
Colour	Black			
Pitch	7.62 mm			
Pol.	L1	(inch)	Qty.	Order No.
2	7.62	0.300	65	1061110000
3	15.24	0.600	50	1061120000

Representative deratings curve

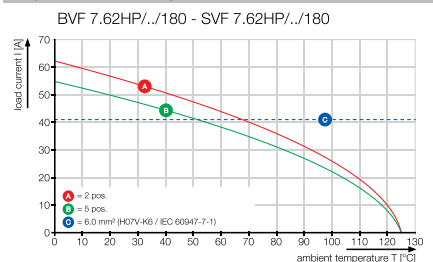

SVF 7.62HP../180MSF3



Dimensioned drawing

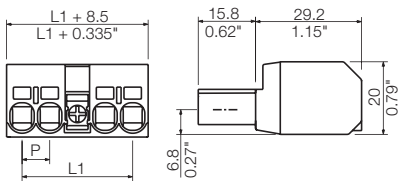

Ordering data

Solder pin length				
Colour				Black
Pitch 7.62 mm				
Pol.	L1	(inch)	Qty.	Order No.
3	15.24	0.600	50	1061130000
4	22.86	0.900	40	1061140000
5	30.48	1.200	30	1061150000

SVF 7.62HP../180MSF4

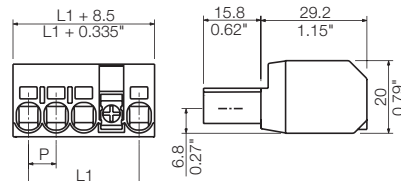

Ordering data

Solder pin length				
Colour				Black
Pitch 7.62 mm				
Pol.	L1	(inch)	Qty.	Order No.
5	30.48	1.200	30	1061170000

Connectors in 7.62 mm pitch
Series BV/SV 7.62 – connects up to 6 mm²

BVZ 7.62HP../180

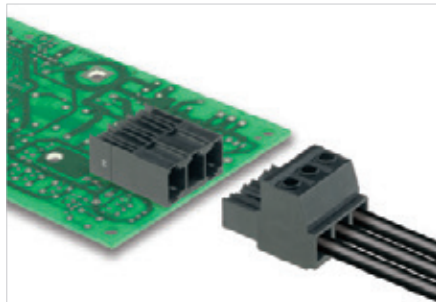

Female plug in 180° outlet direction with clamping yoke screw connection for TNC (S) systems. Meets the requirements of UL1059 for 600 V Use Group C. The mating profile ensures touch-safety of > 3 mm in accordance with IEC 61800-5-1.

Maximum operational reliability: with a derating up to 125 °C, a mating profile that can only be plugged in correct, and unique coding capability.

- Available with a flange (F), screw flange (SF) and clip on screw flange (SFC)

Product data

IEC: 1000 V / 41 A / 0.2 - 6 mm²
 UL: 600 V / 35 A / AWG 24 - 10

For additional articles and information, refer to catalog.weidmueller.com

Note:

- Additional colours on request
- Rated current related to rated cross-section & min. No. of poles.
- Wire end ferrule without plastic collar to DIN 46228/1
- Wire end ferrule with plastic collar to DIN 46228/4
- P on drawing = pitch
- Rated data refer only to the component itself. Clearance and creepage distances to other components are to be designed in accordance with the relevant application standards.

BVZ 7.62HP../180



Dimensioned drawing

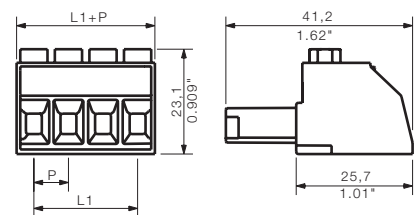

Technical data

In compliance with IEC 60664-1 / IEC 61984			
Clamping range, max.	mm ²	0.2...6	
Solid core H05(07) V-U	mm²	0.2...6	
Stranded H07 V-R			
Flexible H05(07) V-K	mm ²	0.5...6	
Flexible with ferrule	mm ²	0.25...6	
Ferrule with plastic collar	mm ²	0.25...6	
Stripping length	mm	12	
Screwdriver blade	mm	0.8 x 4.5	
According to norm		DIN 5264	
Tightening torque range	Nm	0.5...0.6	
Rated current, max.	A	41	41
At ambient temperature		20°C	40°C
For conductor cross-section	mm ²	6	
Overvoltage category		III	III II
Pollution severity		3	2 2
Rated voltage	V	800	1000 1000
Rated impulse voltage	kV	8	8 6
UL / CUL (Use Group)		B	C D
Rated voltage	V	600	600 600
Rated current	A	35	35 5
AWG conductor	AWG	24-10	
CSA (Use Group)		B	C D
Rated voltage	V	600	600 600
Rated current	A	35	35 5
AWG conductor	AWG	24-10	
General data			
Type of insulation material		PA GF	
UL 94 flammability rating		V-0	
Contact base material		Copper alloy	
Material of contact surface		tinned	
Pin dimensions = d	mm		
Solder eyelet Ø = D	mm		
Solder eyelet Ø tolerance	mm		

Accessories

Note: Refer to the Accessories chapter for additional accessories.

Coding		Order No.
	BV/SV 7.62HP K0	1937590000
Strain relief		
	BV/SV 7.62HP/02 ZE GR	1937550000
	BV/SV 7.62HP/04 ZE GR	1937560000
Screwdriver		
	SDS 0.8X4.0X125	9009020000
Crosshead screwdriver		
	SDK PH1	9008480000

Ordering data

Solder pin length					
Colour	Black				
Pitch	7.62 mm				
Pol.	L1	(inch)	Qty.	Order No.	
2	7.62	0.300	100	1929930000	
3	15.24	0.600	100	1929940000	
4	22.86	0.900	100	1929950000	
5	30.48	1.200	50	1929960000	
6	38.10	1.500	50	1929970000	
7	45.72	1.800	50	1929980000	

Representative deratings curve

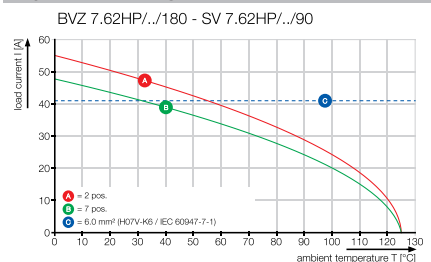

BVZ 7.62HP../180F



Dimensioned drawing

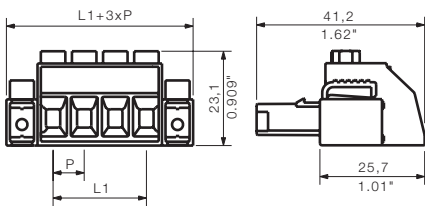

Ordering data

Solder pin length				
Colour		Black		
Pitch 7.62 mm				
Pol.	L1	(inch)	Qty.	Order No.
2	7.62	0.300	100	1930050000
3	15.24	0.600	100	1930060000
4	22.86	0.900	100	1930070000
5	30.48	1.200	50	1930080000
6	38.10	1.500	50	1930090000
7	45.72	1.800	50	1930100000

BVZ 7.62HP../180SF



Dimensioned drawing

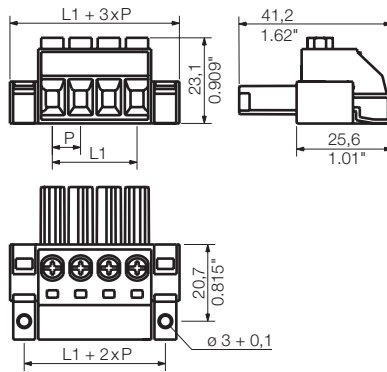

Ordering data

Solder pin length				
Colour		Black		
Pitch 7.62 mm				
Pol.	L1	(inch)	Qty.	Order No.
2	7.62	0.300	100	1930160000
3	15.24	0.600	100	1930170000
4	22.86	0.900	100	1930180000
5	30.48	1.200	50	1930190000
6	38.10	1.500	50	1930200000
7	45.72	1.800	50	1930210000

BVZ 7.62HP../180SFC



Dimensioned drawing

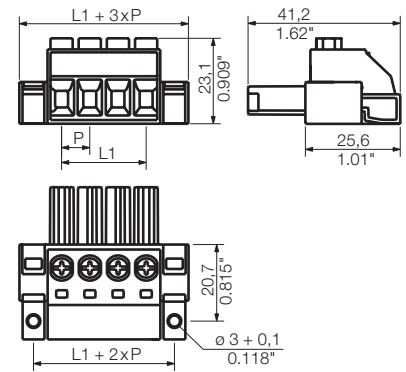

Ordering data

Solder pin length				
Colour		Black		
Pitch 7.62 mm				
Pol.	L1	(inch)	Qty.	Order No.
2	7.62	0.300	100	1929740000
3	15.24	0.600	100	1929750000
4	22.86	0.900	100	1929760000
5	30.48	1.200	50	1929770000
6	38.10	1.500	50	1929780000
7	45.72	1.800	50	1929790000

Also available with a clip-on flange (...180FC).

Additional deratings curves

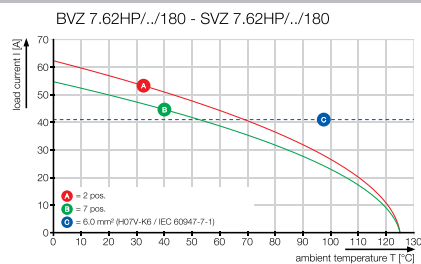
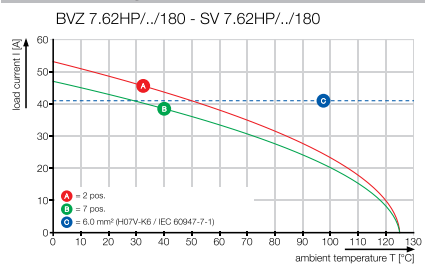

Connectors in 7.62 mm pitch
Series BV/SV 7.62 – connects up to 6 mm²

BVZ 7.62HP../180SH

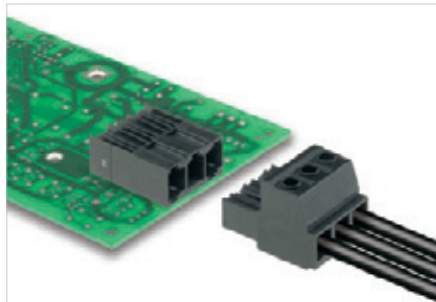

Female plug in 180° outlet direction with clamping yoke screw connection and additional shield connection for TNC (S) systems. Meets the requirements of UL1059 for 600 V Use Group C. The mating profile ensures touch-safety of > 3 mm in accordance with IEC 61800-5-1.

Maximum operational reliability with a derating up to 125 °C, a mating profile that can only be plugged in correct, and unique coding capability.

- Available with shield in three different orientations.

Product data

IEC: 1000 V / 41 A / 0.2 - 6 mm²
 UL: 600 V / 35 A / AWG 24 - 10

For additional articles and information, refer to catalog.weidmueller.com

Note:

- Additional colours on request
- Rated current related to rated cross-section & min. No. of poles.
- Wire end ferrule without plastic collar to DIN 46228/1
- Wire end ferrule with plastic collar to DIN 46228/4
- P on drawing = pitch
- Rated data refer only to the component itself. Clearance and creepage distances to other components are to be designed in accordance with the relevant application standards.

BVZ 7.62HP../180SH150



Dimensioned drawing

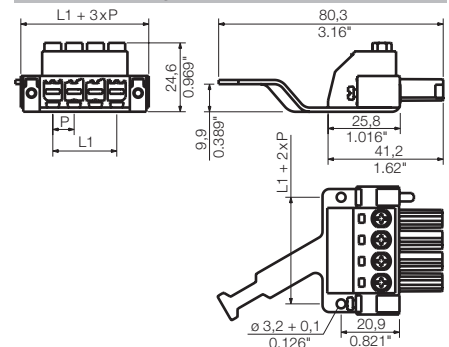

Technical data

In compliance with IEC 60664-1 / IEC 61984			
Clamping range, max.	mm ²	0.2...6	
Solid core H05(07) V-U	mm²	0.2...6	
Stranded H07 V-R			
Flexible H05(07) V-K	mm ²	0.5...6	
Flexible with ferrule	mm ²	0.25...6	
Ferrule with plastic collar	mm ²	0.25...6	
Stripping length	mm	12	
Screwdriver blade	mm	0.8 x 4.5	
According to norm		DIN 5264	
Tightening torque range	Nm	0.5...0.6	
Rated current, max.	A	41	41
At ambient temperature		20°C	40°C
For conductor cross-section	mm ²	6	
Overvoltage category		III	III II
Pollution severity		3	2 2
Rated voltage	V	800	1000 1000
Rated impulse voltage	kV	8	8 6
UL / CUL (Use Group)		B	C D
Rated voltage	V	600	600 600
Rated current	A	35	35 5
AWG conductor	AWG	24-10	
CSA (Use Group)		B	C D
Rated voltage	V	600	600 600
Rated current	A	35	35 5
AWG conductor	AWG	24-10	
General data			
Type of insulation material		PA GF	
UL 94 flammability rating		V-0	
Contact base material		Copper alloy	
Material of contact surface		tinned	
Pin dimensions = d	mm		
Solder eyelet Ø = D	mm		
Solder eyelet Ø tolerance	mm		

Accessories

Note: Refer to the Accessories chapter for additional accessories.

Coding		Order No.
	BV/SV 7.62HP K0	1937590000
Strain relief		
	BV/SV 7.62HP/02 ZE GR	1937550000
	BV/SV 7.62HP/04 ZE GR	1937560000
Screwdriver		
	SDS 0.8x4.0x125	9009020000
Crosshead screwdriver		
	SDK PH1	9008480000

Ordering data

Solder pin length				
Colour	Black			
Pitch	7.62 mm			
Pol.	L1	(inch)	Qty.	Order No.
3	15.24	0.600	50	1929850000
4	22.86	0.900	25	1929860000
5	30.48	1.200	25	1929870000
6	38.10	1.500	25	1929880000

Representative deratings curve

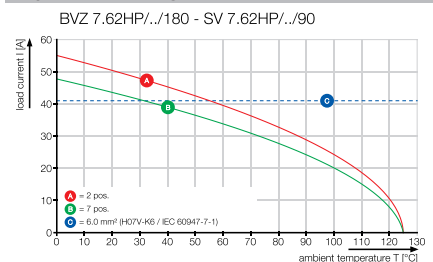

BVZ 7.62HP/./180SH180



BVZ 7.62HP/./180SH210



Dimensioned drawing

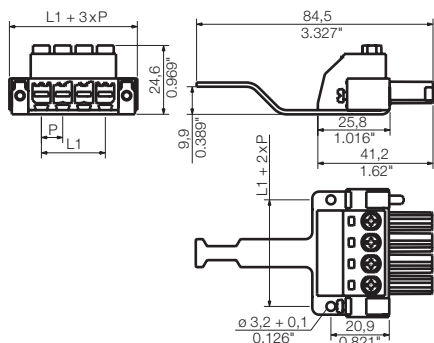

Dimensioned drawing

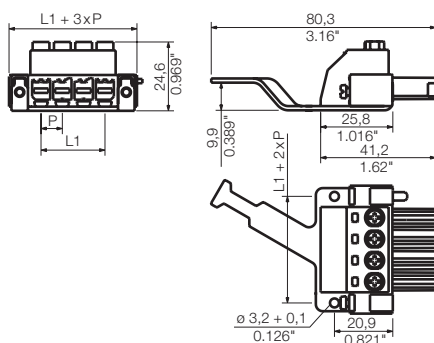

Ordering data

Solder pin length					
Colour					Black
Pitch 7.62 mm					
Pol.	L1	(inch)	Qty.	Order No.	
3	15.24	0.600	50	1933340000	
4	22.86	0.900	25	1933350000	
5	30.48	1.200	25	1933360000	
6	38.10	1.500	25	1933370000	

Ordering data

Solder pin length					
Colour					Black
Pitch 7.62 mm					
Pol.	L1	(inch)	Qty.	Order No.	
3	15.24	0.600	50	1933430000	
4	22.86	0.900	25	1933440000	
5	30.48	1.200	25	1933450000	
6	38.10	1.500	25	1933460000	

Additional deratings curves

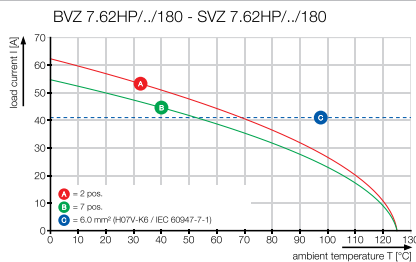
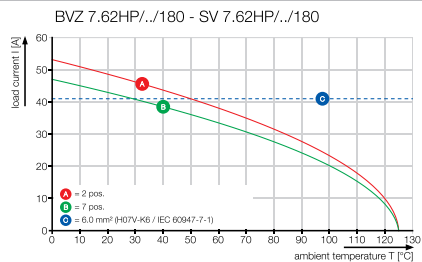

Connectors in 7.62 mm pitch
Series BV/SV 7.62 – connects up to 6 mm²

BVZ 7.62HP../180SH C

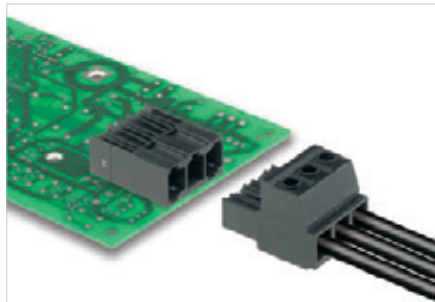

Female plug in 180° outlet direction with clamping yoke screw connection and additional shield connection for TNC (S) systems. Meets the requirements of UL1059 for 600 V Use Group C. The mating profile ensures touch-safety of > 3 mm in accordance with IEC 61800-5-1.

Maximum operational reliability with a derating up to 125 °C, a mating profile that can only be plugged in correct, and unique coding capability.

- Available with shield in three different orientations.

Product data

IEC: 1000 V / 41 A / 0.2 - 6 mm²
 UL: 600 V / 35 A / AWG 24 - 10

For additional articles and information, refer to catalog.weidmueller.com

Note:

- Additional colours on request
- Rated current related to rated cross-section & min. No. of poles.
- Wire end ferrule without plastic collar to DIN 46228/1
- Wire end ferrule with plastic collar to DIN 46228/4
- P on drawing = pitch
- Rated data refer only to the component itself. Clearance and creepage distances to other components are to be designed in accordance with the relevant application standards.

BVZ 7.62HP../180SH150C



Dimensioned drawing

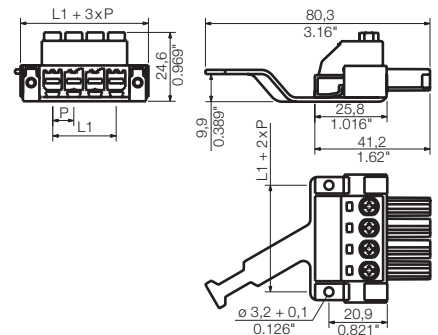

Technical data

In compliance with IEC 60664-1 / IEC 61984			
Clamping range, max.	mm ²	0.2...6	
Solid core H05(07) V-U	mm²	0.2...6	
Stranded H07 V-R			
Flexible H05(07) V-K	mm ²	0.5...6	
Flexible with ferrule	mm ²	0.25...6	
Ferrule with plastic collar	mm ²	0.25...6	
Stripping length	mm	12	
Screwdriver blade	mm	0.8 x 4.5	
According to norm		DIN 5264	
Tightening torque range	Nm	0.5...0.6	
Rated current, max.	A	41	41
At ambient temperature		20°C	40°C
For conductor cross-section	mm ²	6	
Overvoltage category		III	III II
Pollution severity		3	2 2
Rated voltage	V	800	1000 1000
Rated impulse voltage	kV	8	8 6
UL / CUL (Use Group)		B	C D
Rated voltage	V	600	600 600
Rated current	A	35	35 5
AWG conductor	AWG	24-10	
CSA (Use Group)		B	C D
Rated voltage	V	600	600 600
Rated current	A	35	35 5
AWG conductor	AWG	24-10	
General data			
Type of insulation material		PA GF	
UL 94 flammability rating		V-0	
Contact base material		Copper alloy	
Material of contact surface		tinned	
Pin dimensions = d	mm		
Solder eyelet Ø = D	mm		
Solder eyelet Ø tolerance	mm		

Accessories

Note: Refer to the Accessories chapter for additional accessories.

Coding		Order No.
	BV/SV 7.62HP K0	1937590000
Strain relief		
	BV/SV 7.62HP/02 ZE GR	1937550000
	BV/SV 7.62HP/04 ZE GR	1937560000
Screwdriver		
	SDS 0.8x4.0x125	9009020000
Crosshead screwdriver		
	SDK PH1	9008480000

Ordering data

Solder pin length					
Colour	Black				
Pitch	7.62 mm				
Pol.	L1	(inch)	Qty.	Order No.	
3	15.24	0.600	50	1929890000	
4	22.86	0.900	25	1929900000	
5	30.48	1.200	25	1929910000	
6	38.10	1.500	25	1929920000	

Representative deratings curve

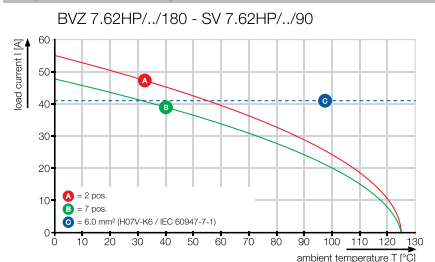

BVZ 7.62HP../180SH180C



BVZ 7.62HP../180SH210C



Dimensioned drawing

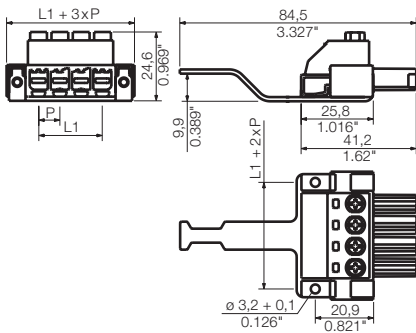

Dimensioned drawing

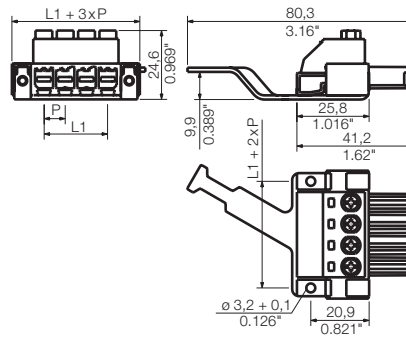

Ordering data

Solder pin length					
Colour					Black
Pitch 7.62 mm					
Pol.	L1	(inch)	Qty.	Order No.	
3	15.24	0.600	50	1933380000	
4	22.86	0.900	25	1933390000	
5	30.48	1.200	25	1933400000	
6	38.10	1.500	25	1933410000	

Ordering data

Solder pin length					
Colour					Black
Pitch 7.62 mm					
Pol.	L1	(inch)	Qty.	Order No.	
3	15.24	0.600	50	1933470000	
4	22.86	0.900	25	1933480000	
5	30.48	1.200	25	1933490000	
6	38.10	1.500	25	1933500000	

Additional deratings curves

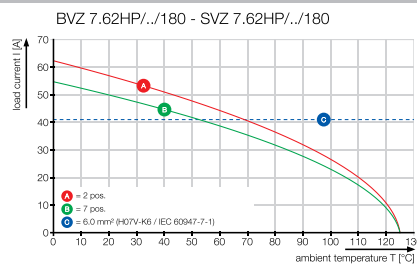
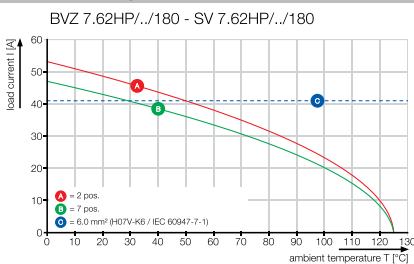

Connectors in 7.62 mm pitch
Series BV/SV 7.62 – connects up to 6 mm²

BVF 7.62HP../180

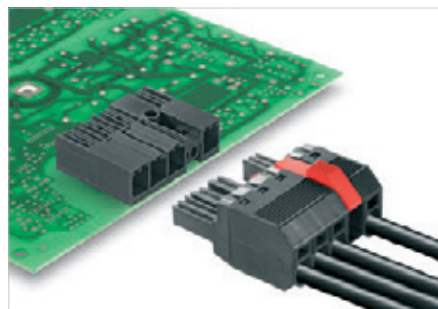

Female plug in 180° outlet direction with PUSH IN spring connection for TNC (S) systems. Meets the requirements of UL1059 for 600 V Use Group C. The mating profile ensures touch-safety of > 3 mm in accordance with IEC 61800-5-1.

Maximum operational reliability with a derating up to 125 °C, a mating profile that can only be plugged in correct, and unique coding capability.

- Available with a flange (F), screw flange (SF) and middle flange (MF).

Product data

IEC: 1000 V / 41 A / 0.5 - 10 mm²
 UL: 600 V / 35 A / AWG 24 - 8

For additional articles and information, refer to catalog.weidmueller.com

Note:

- Additional colours on request
- Rated current related to rated cross-section & min. No. of poles.
- Wire end ferrule without plastic collar to DIN 46228/1
- Wire end ferrule with plastic collar to DIN 46228/4
- P on drawing = pitch
- Rated data refer only to the component itself. Clearance and creepage distances to other components are to be designed in accordance with the relevant application standards.

BVF 7.62HP../180



Dimensioned drawing

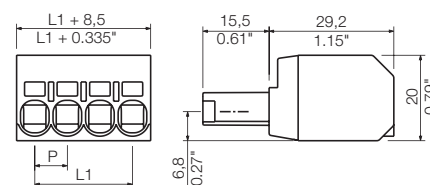

Technical data

In compliance with IEC 60664-1 / IEC 61984			
Clamping range, max.	mm ²	0.5...10	
Solid core H05(07) V-U	mm²	0.5...10	
Stranded H07 V-R			
Flexible H05(07) V-K	mm ²	0.5...10	
Flexible with ferrule	mm ²	1.5...6	
Ferrule with plastic collar	mm ²	1.5...6	
Stripping length	mm	12	
Screwdriver blade	mm	0.8 x 4.5	
According to norm		DIN 5264	
Tightening torque range	Nm		
Rated current, max.	A	41	41
At ambient temperature		20°C	40°C
For conductor cross-section	mm ²	6	
Overvoltage category		III	III II
Pollution severity		3	2 2
Rated voltage	V	800	1000 1000
Rated impulse voltage	kV	8	8 6
UL / CUL (Use Group)		B	C D
Rated voltage	V	600	600 600
Rated current	A	35	35 5
AWG conductor	AWG		24-8
CSA (Use Group)		B	C D
Rated voltage	V	600	600 600
Rated current	A	35	35 5
AWG conductor	AWG	24-8	
General data			
Type of insulation material		PA GF	
UL 94 flammability rating		V-0	
Contact base material		Copper alloy	
Material of contact surface		tinned	
Pin dimensions = d	mm		
Solder eyelet Ø = D	mm		
Solder eyelet Ø tolerance	mm		

Accessories

Note: Refer to the Accessories chapter for additional accessories.

Coding		Order No.
	BV/SV 7.62HP K0	1937590000
Screwdriver		
	SDS 0.8x4.0x125	9009020000
Crimping tool		
	PZ 6/5	9011460000

Ordering data

Solder pin length				
Colour	Black			
Pitch	7.62 mm			
Pol.	L1	(inch)	Qty.	Order No.
2	7.62	0.300	95	1060390000
3	15.24	0.600	65	1060400000
4	22.86	0.900	45	1060410000
5	30.48	1.200	40	1060420000

Representative deratings curve

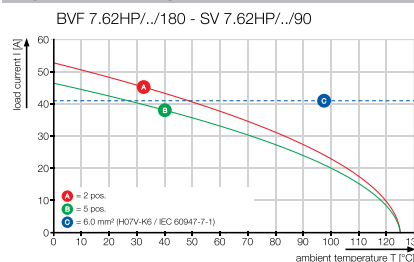

BVF 7.62HP../180F



Dimensioned drawing

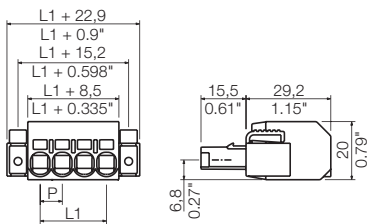

BVF 7.62HP../180SF



Dimensioned drawing

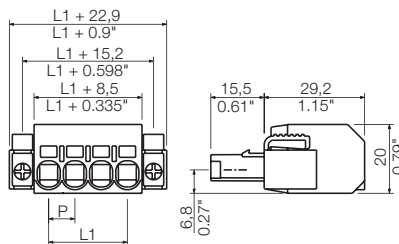

Ordering data

Solder pin length					
Colour					Black
Pitch 7.62 mm					
Pol.	L1	(inch)	Qty.	Order No.	
2	7.62	0.300	50	1060440000	
3	15.24	0.600	40	1060450000	
4	22.86	0.900	30	1060470000	
5	30.48	1.200	25	1060480000	
6	38.10	1.500	25	1060490000	

Ordering data

Solder pin length					
Colour					Black
Pitch 7.62 mm					
Pol.	L1	(inch)	Qty.	Order No.	
2	7.62	0.300	50	1060500000	
3	15.24	0.600	40	1060510000	
4	22.86	0.900	30	1060520000	
5	30.48	1.200	25	1060530000	
6	38.10	1.500	25	1060540000	

Additional deratings curves

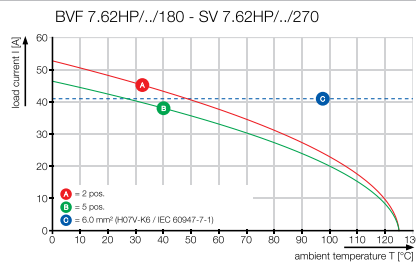
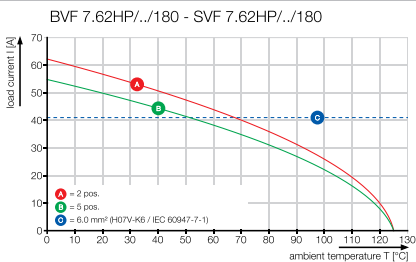

Connectors in 7.62 mm pitch
Series BV/SV 7.62 – connects up to 6 mm²

BVF 7.62HP../180MF

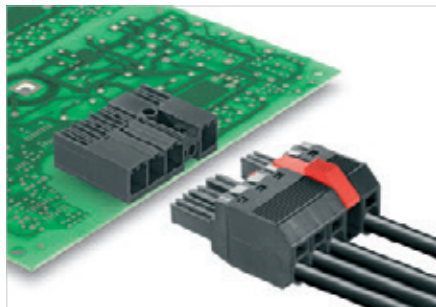

Female plug in 180° outlet direction with PUSH IN spring connection for TNC (S) systems. Meets the requirements of UL1059 for 600 V Use Group C. The mating profile ensures touch-safety of > 3 mm in accordance with IEC 61800-5-1.

Maximum operational reliability with a derating up to 125 °C, a mating profile that can only be plugged in correct, and unique coding capability.

- Middle flange available in positions 2, 3 and 4.

Product data

IEC: 1000 V / 41 A / 0.5 - 10 mm²
 UL: 600 V / 35 A / AWG 24 - 8

For additional articles and information, refer to catalog.weidmueller.com

Note:

- Additional colours on request
- Rated current related to rated cross-section & min. No. of poles.
- Wire end ferrule without plastic collar to DIN 46228/1
- Wire end ferrule with plastic collar to DIN 46228/4
- P on drawing = pitch
- Rated data refer only to the component itself. Clearance and creepage distances to other components are to be designed in accordance with the relevant application standards.

BVF 7.62HP../180MF2

Dimensioned drawing

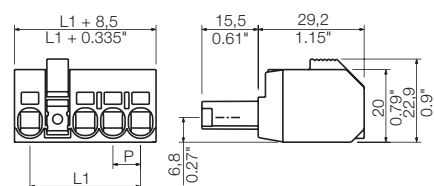

Technical data

In compliance with IEC 60664-1 / IEC 61984			
Clamping range, max.	mm ²	0.5...10	
Solid core H05(07) V-U	mm²	0.5...10	
Stranded H07 V-R			
Flexible H05(07) V-K	mm ²	0.5...10	
Flexible with ferrule	mm ²	1.5...6	
Ferrule with plastic collar	mm ²	1.5...6	
Stripping length	mm	12	
Screwdriver blade	mm	0.8 x 4.5	
According to norm		DIN 5264	
Tightening torque range	Nm		
Rated current, max.	A	41	41
At ambient temperature		20°C	40°C
For conductor cross-section	mm ²	6	
Overvoltage category		III	III II
Pollution severity		3	2 2
Rated voltage	V	800	1000 1000
Rated impulse voltage	kV	8	8 6
UL / CUL (Use Group)		B	C D
Rated voltage	V	600	600 600
Rated current	A	35	35 5
AWG conductor	AWG	24-8	
CSA (Use Group)		B	C D
Rated voltage	V	600	600 600
Rated current	A	35	35 5
AWG conductor	AWG	24-8	
General data			
Type of insulation material		PA GF	
UL 94 flammability rating		V-0	
Contact base material		Copper alloy	
Material of contact surface		tinned	
Pin dimensions = d	mm		
Solder eyelet Ø = D	mm		
Solder eyelet Ø tolerance	mm		

Accessories

Note: Refer to the Accessories chapter for additional accessories.

Coding	Order No.
BV/SV 7.62HP K0	1937590000
Strain relief	
BV/SV 7.62HP/02 ZE GR	1937560000
BV/SV 7.62HP/04 ZE GR	1937560000
Screwdriver	
SDS 0.8X4.0X125	9009020000
Crimping tool	
PZ 6/5	9011460000

Ordering data

Solder pin length				
Colour	Black			
Pitch	7.62 mm			
Pol.	L1	(inch)	Qty.	Order No.
2	7.62	0.300	65	1060550000
3	15.24	0.600	50	1060570000

Representative deratings curve

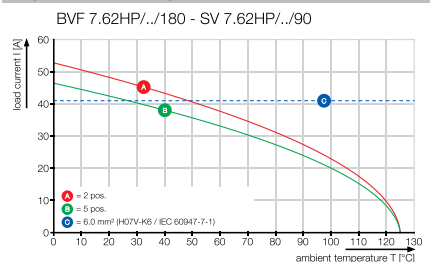

BVF 7.62HP../180MF3



Dimensioned drawing

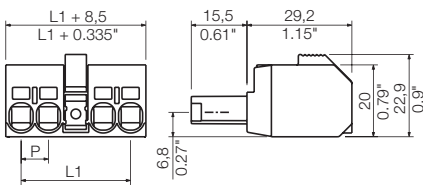

Ordering data

Solder pin length				
Colour	Black			
Pitch	7.62 mm			
Pol.	L1	(inch)	Qty.	Order No.
3	15.24	0.600	50	1060580000
4	22.86	0.900	40	1060590000
5	30.48	1.200	30	1060600000

BVF 7.62HP../180MF4

Dimensioned drawing

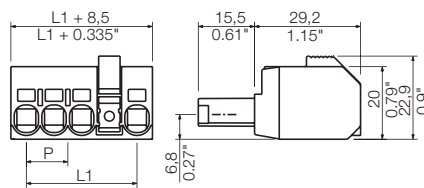

Ordering data

Solder pin length				
Colour	Black			
Pitch	7.62 mm			
Pol.	L1	(inch)	Qty.	Order No.
5	30.48	1.200	30	1060610000

Additional deratings curves

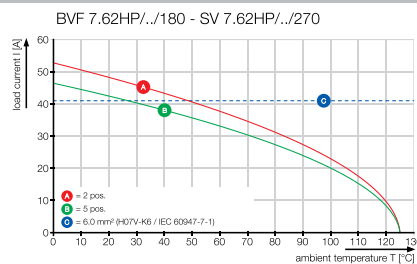
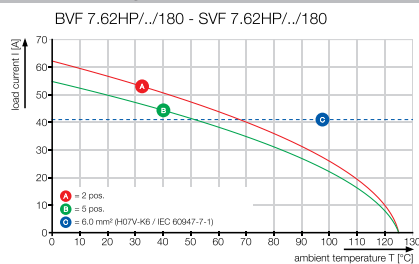

Connectors in 7.62 mm pitch
Series BV/SV 7.62 – connects up to 6 mm²

BVF 7.62HP../180MSF

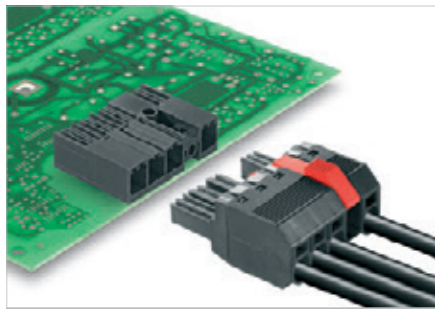

Female plug in 180° outlet direction with PUSH IN spring connection for TNC (S) systems. Meets the requirements of UL1059 for 600 V Use Group C. The mating profile ensures touch-safety of > 3 mm in accordance with IEC 61800-5-1.

Maximum operational reliability with a derating up to 125 °C, a mating profile that can only be plugged in correct, and unique coding capability.

- Middle flange available in positions 2, 3 and 4.

Product data

IEC: 1000 V / 41 A / 0.5 - 10 mm²
 UL: 600 V / 35 A / AWG 24 - 8

For additional articles and information, refer to catalog.weidmueller.com

Note:

- Additional colours on request
- Rated current related to rated cross-section & min. No. of poles.
- Wire end ferrule without plastic collar to DIN 46228/1
- Wire end ferrule with plastic collar to DIN 46228/4
- P on drawing = pitch
- Rated data refer only to the component itself. Clearance and creepage distances to other components are to be designed in accordance with the relevant application standards.

BVF 7.62HP../180MSF2

Dimensioned drawing

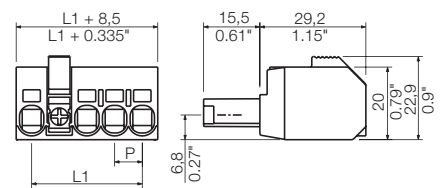

Technical data

In compliance with IEC 60664-1 / IEC 61984			
Clamping range, max.	mm ²	0.5...10	
Solid core H05(07) V-U	mm²	0.5...10	
Stranded H07 V-R			
Flexible H05(07) V-K	mm ²	0.5...10	
Flexible with ferrule	mm ²	1.5...6	
Ferrule with plastic collar	mm ²	1.5...6	
Stripping length	mm	12	
Screwdriver blade	mm	0.8 x 4.5	
According to norm		DIN 5264	
Tightening torque range	Nm		
Rated current, max.	A	41	41
At ambient temperature		20°C	40°C
For conductor cross-section	mm ²	6	
Overvoltage category		III	III II
Pollution severity		3	2 2
Rated voltage	V	800	1000 1000
Rated impulse voltage	kV	8	8 6
UL / CUL (Use Group)		B	C D
Rated voltage	V	600	600 600
Rated current	A	35	35 5
AWG conductor	AWG		24-8
CSA (Use Group)		B	C D
Rated voltage	V	600	600 600
Rated current	A	35	35 5
AWG conductor	AWG	24-8	
General data			
Type of insulation material		PA GF	
UL 94 flammability rating		V-0	
Contact base material		Copper alloy	
Material of contact surface		tinned	
Pin dimensions = d	mm		
Solder eyelet Ø = D	mm		
Solder eyelet Ø tolerance	mm		

Accessories

Note: Refer to the Accessories chapter for additional accessories.

Coding	Order No.
BV/SV 7.62HP K0	1937590000
Screwdriver	
SDS 0.8x4.0x125	9009020000
Crimping tool	
PZ 6/5	9011460000

Ordering data

Solder pin length				
Colour	Black			
Pitch	7.62 mm			
Pol.	L1	(inch)	Qty.	Order No.
2	7.62	0.300	65	1060630000
3	15.24	0.600	50	1060640000

Representative deratings curve

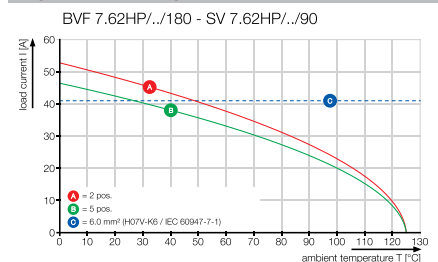

BVF 7.62HP../180MSF3



Dimensioned drawing

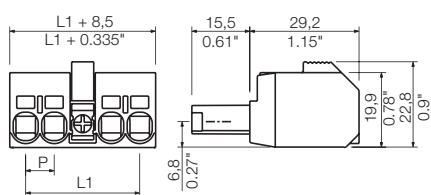

Ordering data

Solder pin length					
Colour					Black
Pitch 7.62 mm					
Pol.	L1	(inch)	Qty.	Order No.	
3	15.24	0.600	50	1060650000	
4	22.86	0.900	40	1060670000	
5	30.48	1.200	30	1060680000	

BVF 7.62HP../180MSF4

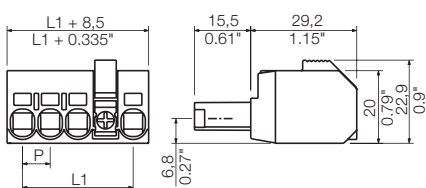

Ordering data

Solder pin length					
Colour					Black
Pitch 7.62 mm					
Pol.	L1	(inch)	Qty.	Order No.	
5	30.48	1.200	30	1060690000	

Additional deratings curves

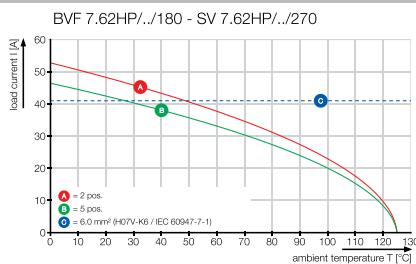
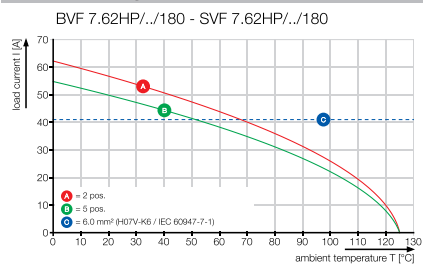

Connectors in 7.62 mm pitch
Series BV/SV 7.62 – connects up to 6 mm²

BVL 7.62HP/./90

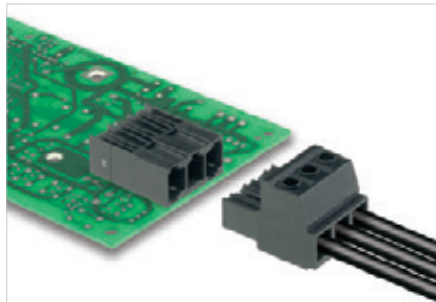

Touch-safe female header in 90° outlet direction. Meets the requirements of IEC 61800-5-1 and allows UL approval in accordance with UL508 / UL840 for 600 V. An ideal touch-safe solution for power output and DC-link applications. According to IEC 61800-5-1, the mating profile ensures more than 3 mm of touch safety.

Maximum operational reliability: with a derating up to 125 °C, a mating profile that can only be plugged in correct, and unique coding capability.

- Available with a flange (F) and screw flange (SFI).

Product data

IEC: 1000 V / 41 A
 UL: 300 V / 35 A

For additional articles and information, refer to catalog.weidmueller.com

Note:

- Additional colours on request
- Rated current related to rated cross-section & min. No. of poles.
- P on drawing = pitch
- Rated data refer only to the component itself. Clearance and creepage distances to other components are to be designed in accordance with the relevant application standards.

BVL 7.62HP/./90



Dimensioned drawing

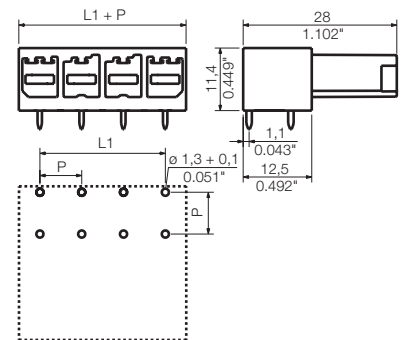

Technical data

In compliance with IEC 60664-1 / IEC 61984			
Clamping range, max.	mm ²		
Solid core H05(07) V-U	mm²		
Stranded H07 V-R			
Flexible H05(07) V-K	mm ²		
Flexible with ferrule	mm ²		
Ferrule with plastic collar	mm ²		
Stripping length	mm		
Screwdriver blade	mm		
According to norm			
Tightening torque range	Nm		
Rated current, max.	A	41	41
At ambient temperature		20°C	40°C
For conductor cross-section	mm ²		
Overtoltage category		III	III II
Pollution severity		3	2 2
Rated voltage	V	630	630 1000
Rated impulse voltage	kV	6	6 6
UL / CUL (Use Group)		B	C D
Rated voltage	V	300	300 600
Rated current	A	35	35 5
AWG conductor	AWG		-
CSA (Use Group)		B	C D
Rated voltage	V	300	300 600
Rated current	A	35	35 5
AWG conductor	AWG		-
General data			
Type of insulation material		PA GF	
UL 94 flammability rating		V-0	
Contact base material		Copper alloy	
Material of contact surface		tinned	
Pin dimensions = d	mm	0.8 x 1.0	
Solder eyelet Ø = D	mm	1.3	
Solder eyelet Ø tolerance	mm	+ 0,1	

Accessories

Note: Refer to the Accessories chapter for additional accessories.

Coding		Order No.
	BV/SV 7.62HP KO	1937590000

Ordering data

Solder pin length		3.5 mm		
Colour		Black		
Pitch		7.62 mm		
Pol.	L1	(inch)	Qty.	Order No.
2	7.62	0.300	100	1928280000
3	15.24	0.600	100	1928290000
4	22.86	0.900	100	1928300000
5	30.48	1.200	50	1928310000
6	38.10	1.500	50	1928320000
7	45.72	1.800	50	1928330000

BVL 7.62HP.././90FI



BVL 7.62HP.././90SFI



Dimensioned drawing

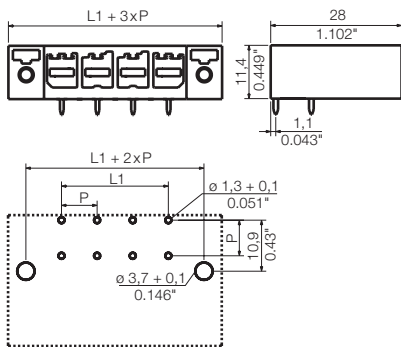

Dimensioned drawing

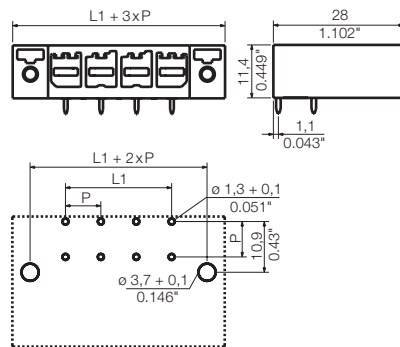

Ordering data

Solder pin length		3.5 mm		
Colour		Black		
Pitch		7.62 mm		
Pol.	L1	(inch)	Qty.	Order No.
2	7.62	0.300	100	1928390000
3	15.24	0.600	100	1928400000
4	22.86	0.900	100	1928410000
5	30.48	1.200	50	1928420000
6	38.10	1.500	50	1928430000
7	45.72	1.800	50	1928440000

Ordering data

Solder pin length		3.5 mm		
Colour		Black		
Pitch		7.62 mm		
Pol.	L1	(inch)	Qty.	Order No.
2	7.62	0.300	100	1928500000
3	15.24	0.600	100	1928510000
4	22.86	0.900	100	1928520000
5	30.48	1.200	50	1928530000
6	38.10	1.500	50	1928540000
7	45.72	1.800	50	1928550000

Connectors in 7.62 mm pitch
Series BV/SV 7.62 – connects up to 6 mm²

BVL 7.62HP/./180

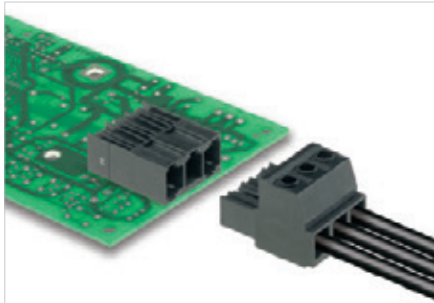

Touch-safe female header in 180° outlet direction. Meets the requirements of IEC 61800-5-1 and allows UL approval in accordance with UL508 / UL840 for 600 V. An ideal touch-safe solution for power output and DC-link applications. According to IEC 61800-5-1, the mating profile ensures more than 3 mm of touch safety.

Maximum operational reliability with a derating up to 125 °C, a mating profile that can only be plugged in correct, and unique coding capability.

- Available with a flange (F) and screw flange (SFI).

Product data

IEC: 1000 V / 41 A
 UL: 300 V / 35 A

For additional articles and information, refer to catalog.weidmueller.com

Note:

- Additional colours on request
- Rated current related to rated cross-section & min. No. of poles.
- P on drawing = pitch
- Rated data refer only to the component itself. Clearance and creepage distances to other components are to be designed in accordance with the relevant application standards.

BVL 7.62HP/./180



Dimensioned drawing

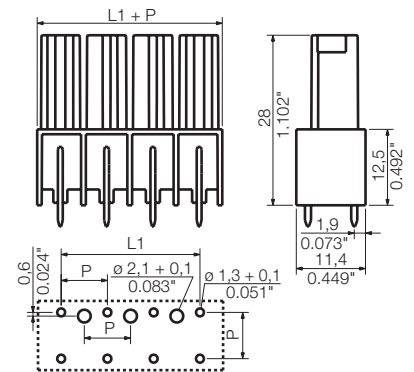

Technical data

In compliance with IEC 60664-1 / IEC 61984

Clamping range, max.	mm ²	
Solid core H05(07) V-U	mm²	
Stranded H07 V-R		
Flexible H05(07) V-K	mm ²	
Flexible with ferrule	mm ²	
Ferrule with plastic collar	mm ²	
Stripping length	mm	
Screwdriver blade	mm	

According to norm

Tightening torque range	Nm			
Rated current, max.	A	41	41	
At ambient temperature		20°C	40°C	
For conductor cross-section	mm ²			
Overtolerance category		III	III	II
Pollution severity		3	2	2
Rated voltage	V	630	630	1000
Rated impulse voltage	kV	6	6	6

UL / CUL (Use Group)	B	C	D	
Rated voltage	V	300	300	600
Rated current	A	35	35	5
AWG conductor	AWG			
CSA (Use Group)	B	C	D	

Rated voltage	V	300	300	600
Rated current	A	35	35	5
AWG conductor	AWG			

General data	
Type of insulation material	PA GF
UL 94 flammability rating	V-0
Contact base material	Copper alloy
Material of contact surface	tinned
Pin dimensions = d	mm 0.8 x 1.0
Solder eyelet Ø = D	mm 1.3
Solder eyelet Ø tolerance	mm + 0,1

Accessories

Note: Refer to the Accessories chapter for additional accessories.

Coding		Order No.
	BV/SV 7.62HP K0	1937590000
Protection against twisting		
	VDS180 SV7.62	1853940000

Ordering data

Solder pin length	3.5 mm			
Colour	Black			
Pitch	7.62 mm			
Pol.	L1	(inch)	Qty.	Order No.
2	7.62	0.300	100	1928610000
3	15.24	0.600	100	1928620000
4	22.86	0.900	100	1928630000
5	30.48	1.200	50	1928650000
6	38.10	1.500	50	1928660000
7	45.72	1.800	50	1928670000

Representative deratings curve

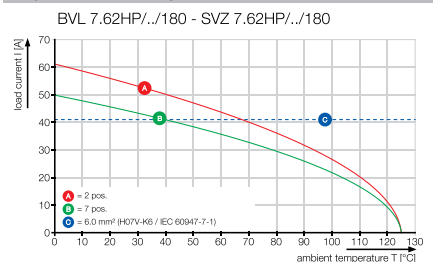

BVL 7.62HP../180FI



BVL 7.62HP../180SFI



Dimensioned drawing

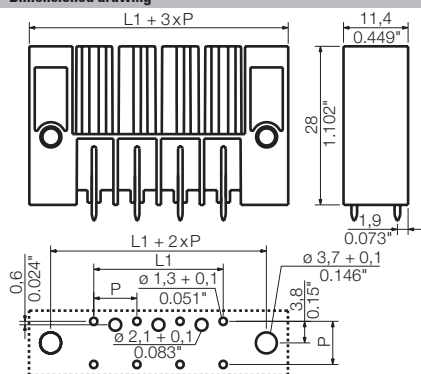

Dimensioned drawing

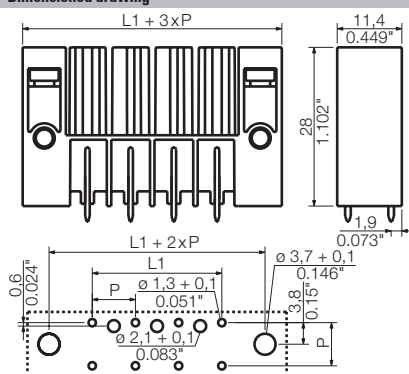

Ordering data

Solder pin length		3.5 mm		
Colour		Black		
Pitch		7.62 mm		
Pol.	L1	(inch)	Qty.	Order No.
2	7.62	0.300	100	1928730000
3	15.24	0.600	100	1928740000
4	22.86	0.900	100	1928750000
5	30.48	1.200	50	1928760000
6	38.10	1.500	50	1928770000
7	45.72	1.800	50	1928780000

Ordering data

Solder pin length		3.5 mm		
Colour		Black		
Pitch		7.62 mm		
Pol.	L1	(inch)	Qty.	Order No.
2	7.62	0.300	100	1928840000
3	15.24	0.600	100	1928850000
4	22.86	0.900	100	1928860000
5	30.48	1.200	50	1928870000
6	38.10	1.500	50	1928900000
7	45.72	1.800	50	1928910000

Additional deratings curves

BVL 7.62HP../180 - SV 7.62HP../180

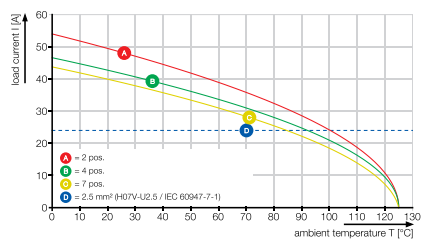

BVL 7.62HP../180 - SV 7.62HP../90

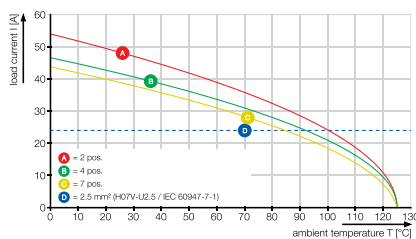

Connectors in 7.62 mm pitch
Series BV/SV 7.62 – connects up to 6 mm²

BVL 7.62HP/./270

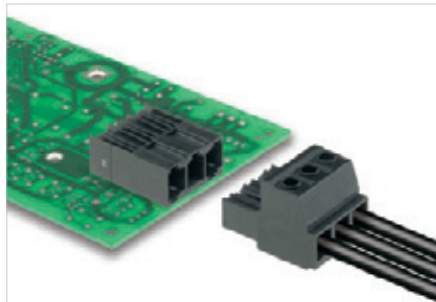

Touch-safe female header in 270° outlet direction. Meets the requirements of IEC 61800-5-1 and allows UL approval in accordance with UL508 / UL840 for 600 V. An ideal touch-safe solution for power output and DC-link applications. According to IEC 61800-5-1, the mating profile ensures more than 3 mm of touch safety.

Maximum operational reliability: with a derating up to 125 °C, a mating profile that can only be plugged in correct, and unique coding capability.

- Available with a flange (FI) and screw flange (SFI).

Product data

IEC: 1000 V / 41 A
 UL: 300 V / 35 A

For additional articles and information, refer to catalog.weidmueller.com

Note:

- Additional colours on request
- Rated current related to rated cross-section & min. No. of poles.
- P on drawing = pitch
- Rated data refer only to the component itself. Clearance and creepage distances to other components are to be designed in accordance with the relevant application standards.

BVL 7.62HP/./270

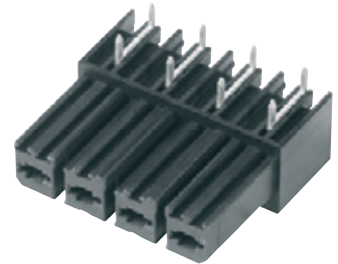

Dimensioned drawing

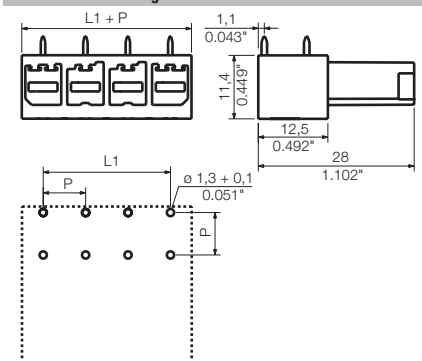

Technical data

In compliance with IEC 60664-1 / IEC 61984

Clamping range, max.	mm ²		
Solid core H05(07) V-U	mm²		
Stranded H07 V-R			
Flexible H05(07) V-K	mm ²		
Flexible with ferrule	mm ²		
Ferrule with plastic collar	mm ²		
Stripping length	mm		
Screwdriver blade	mm		
According to norm			
Tightening torque range	Nm		
Rated current, max.	A	41	41
At ambient temperature		20°C	40°C
For conductor cross-section	mm ²		
Overvoltage category		III	III II
Pollution severity		3	2 2
Rated voltage	V	630	630 1000
Rated impulse voltage	kV	6	6 6
UL / CUL (Use Group)		B	C D
Rated voltage	V	300	300 600
Rated current	A	35	35 5
AWG conductor	AWG		-
CSA (Use Group)		B	C D
Rated voltage	V	300	300 600
Rated current	A	35	35 5
AWG conductor	AWG		-
General data			
Type of insulation material		PA GF	
UL 94 flammability rating		V-0	
Contact base material		Copper alloy	
Material of contact surface		tinned	
Pin dimensions = d	mm	0.8 x 1.0	
Solder eyelet Ø = D	mm	1.3	
Solder eyelet Ø tolerance	mm	+ 0,1	

Accessories

Note: Refer to the Accessories chapter for additional accessories.

Coding	Order No.
BV/SV 7.62HP K0	1937590000



Ordering data

Solder pin length		3.5 mm		
Colour		Black		
Pitch		7.62 mm		
Pol.	L1	(inch)	Qty.	Order No.
2	7.62	0.300	100	1929300000
3	15.24	0.600	100	1929310000
4	22.86	0.900	100	1929320000
5	30.48	1.200	50	1929330000
6	38.10	1.500	50	1929340000
7	45.72	1.800	50	1929350000

BVL 7.62HP../270FI

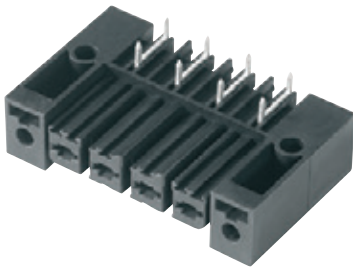

BVL 7.62HP../270SFI

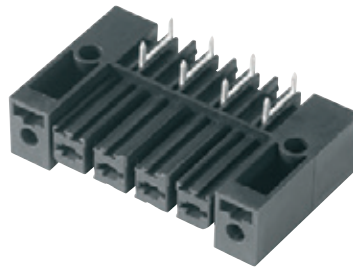

Dimensioned drawing

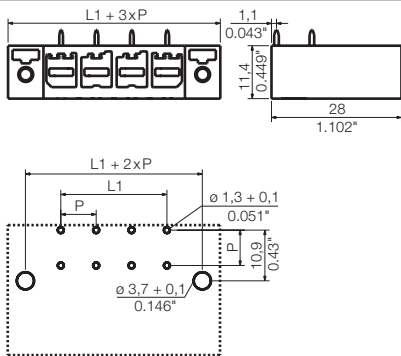

Dimensioned drawing

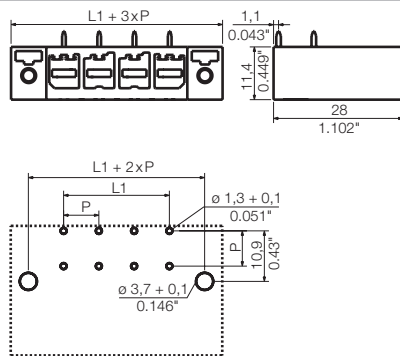

Ordering data

Solder pin length		3.5 mm			
Colour		Black			
Pitch		7.62 mm			
Pol.	L1	(inch)	Qty.	Order No.	
2	7.62	0.300	100	1929410000	
3	15.24	0.600	100	1929420000	
4	22.86	0.900	100	1929430000	
5	30.48	1.200	50	1929440000	
6	38.10	1.500	50	1929450000	
7	45.72	1.800	50	1929460000	

Ordering data

Solder pin length		3.5 mm			
Colour		Black			
Pitch		7.62 mm			
Pol.	L1	(inch)	Qty.	Order No.	
2	7.62	0.300	100	1929520000	
3	15.24	0.600	100	1929530000	
4	22.86	0.900	100	1929540000	
5	30.48	1.200	50	1929550000	
6	38.10	1.500	50	1929560000	
7	45.72	1.800	50	1929570000	

Increased current for better performance

The top class in the OMNIMATE Power SU / BUZ 10.16HP connector system features a very durable contact system which makes it a pluggable power transmission solution with maximum load reserves.

HP stands for High Performance – performance exemplified by a long-term usage temperature of 120 °C. This custom, pluggable solution is suitable for all applications that must meet 600 V UL or 1,000 V (IEC) with up to 76 A (IEC) and 54 A (UL).

F

Compact reliability

Silver-plated contacts with stainless-steel top springs can tolerate short-circuit currents of 1,000 A for one second. Weidmüller's classic clamping yoke features a plus-minus screw and is protected against under insertion. It ensures a long-term, reliable connection.

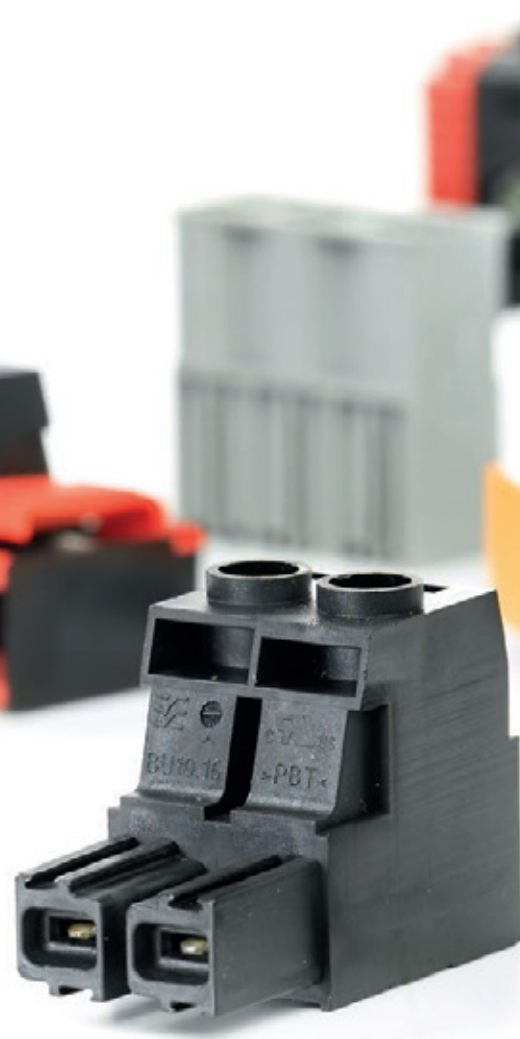



High system performance

The OMNIMATE Power System up to 16 mm² can be individually combined with plugging mates that have an interlocking flange. It is also possible for the plugging mate to be screwed on.

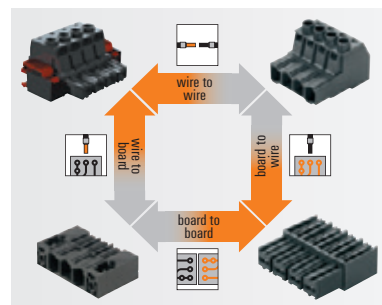

Individualised configuration

Clear printed labelling and customised coding are used to prevent damage that could be caused by installation mistakes.

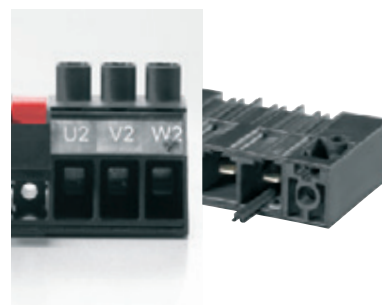

Compact integration

No compromises during design and approval: compact and standard-compliant with additional + 3.0 mm finger safety, according to IEC 61800-5-1, and increased creepage and clearance distances according to UL.

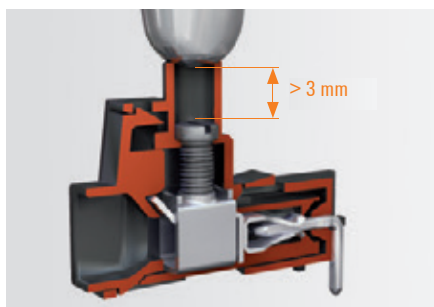

<http://www.OMNIMATE.net>

○ = Wire-to-Board
 ● = Board-to-Board
 ● = Wire-to-Wire
 ● = Board-to-Wire

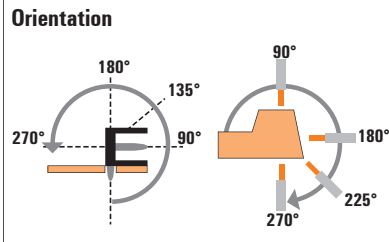

BU/SU 10.16 series



Type	Orientation	Flange options	Product code numbers
			Page

Female plug	 Screw Clamping yoke		BUZ	180°	(G)/F/SF	IEC: 1.000 V/78 A/0.2 - 16 mm ² UL: 600 V/54 A/AWG 22 - 6	F.88
			Female header	 Solder connection		BUL	180°

Female:
 (G) = without flange
 F = Interlock flange
 SF = Interlock flange with screw

Pin:
 G = Closed (without flange)
 F = Interlock flange
 SF = Interlock flange with nut

Male header	Male plug
 Solder connection	 Screw Clamping yoke



SU	SU	SU	SUZ
90°	180°	270°	180°
G/F	G/F/SF	G/F/SF	G
IEC: 1.000 V/76 A/ UL: 300 V/54 A	IEC: 1.000 V/76 A/ UL: 300 V/54 A	IEC: 1.000 V/76 A/ UL: 300 V/54 A	IEC: 1.000 V/78 A/ 0.2 - 16 mm ² UL: 600 V/54 A/ AWG 24 - 6
F.80	F.82	F.84	F.86
○	○	○	●
●	●	●	●

Connectors in 10.16 mm pitch
Series BU/SU 10.16 – connects up to 16 mm²

SU 10.16HP/./90

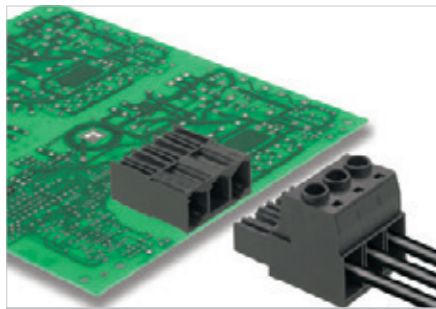

Male header in 90° outlet direction for TNC (S) systems. UL approved for 600 V in accordance with UL508 / UL840. The mating profile ensures touch-safety of more than 3 mm according to IEC 61800-5-1. Maximum operational reliability with a derating up to 125 °C, a mating profile that can only be plugged in correct and unique coding capability.

- Available with a flange (F) and screw flange (SF).

Product data

IEC: 1000 V / 76 A
 UL: 300 V / 54 A

For additional articles and information, refer to catalog.weidmueller.com

Note:

- Additional colours on request
- Rated current related to rated cross-section & min. No. of poles.
- The data given under CSA relates to a cUL approval - E60693
- P on drawing = pitch
- Rated data refer only to the component itself. Clearance and creepage distances to other components are to be designed in accordance with the relevant application standards.

SU 10.16HP/./90G

without flanges



Dimensioned drawing

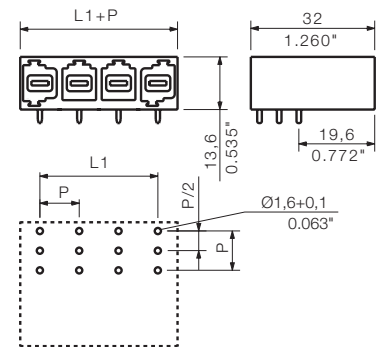

Technical data

In compliance with IEC 60664-1 / IEC 61984			
Clamping range, max.	mm ²		
Solid core H05(07) V-U	mm²		
Stranded H07 V-R			
Flexible H05(07) V-K	mm ²		
Flexible with ferrule	mm ²		
Ferrule with plastic collar	mm ²		
Stripping length	mm		
Screwdriver blade	mm		
According to norm			
Tightening torque range	Nm		
Rated current, max.	A	76	72
At ambient temperature		20°C	40°C
For conductor cross-section	mm ²		
Overvoltage category		III	III II
Pollution severity		3	2 2
Rated voltage	V	690	1000 1000
Rated impulse voltage	kV	8	8 6
UL / CUL (Use Group)		B	C D
Rated voltage	V	300	300 600
Rated current	A	54	54 5
AWG conductor	AWG		-
CSA (Use Group)		B	C D
Rated voltage	V	300	300 600
Rated current	A	54	54 5
AWG conductor	AWG		-
General data			
Type of insulation material		PBT GF	
UL 94 flammability rating		V-0	
Contact base material		Copper alloy	
Material of contact surface		silver-plated	
Pin dimensions = d	mm	1.2 x 1.1	
Solder eyelet Ø = D	mm	1.6	
Solder eyelet Ø tolerance	mm	+ 0,1	

Accessories

Note: Refer to the Accessories chapter for additional accessories.

Coding	Order No.
KO BV/SV.7.62	1824410000

Ordering data

Solder pin length		3.5 mm		
Colour		Black		
Pitch		10.16 mm		
Pol.	L1	(inch)	Qty.	Order No.
2	10.16	0.400	50	1813330000
3	20.32	0.800	50	1813340000
4	30.48	1.200	50	1813350000
5	40.64	1.600	20	1813360000
6	50.80	2.000	20	1813370000
7	60.96	2.400	20	1813380000
8	71.12	2.800	20	1813390000
9	81.28	3.200	20	1813400000

SU 10.16HP/./90F

Interlock flanges



SU 10.16HP/./90SF

Interlock flanges with nuts



Dimensioned drawing

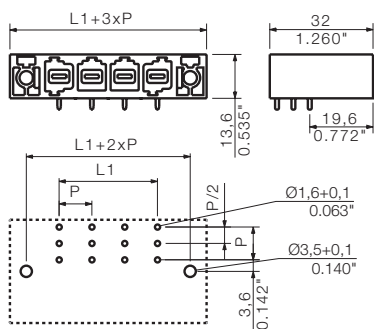

Dimensioned drawing

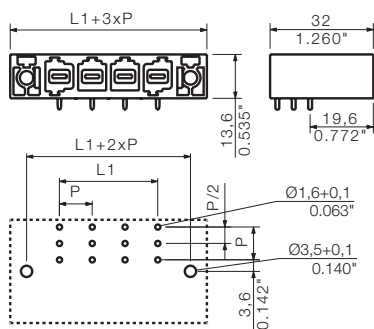

Ordering data

Solder pin length		3.5 mm			
Colour		Black			
Pitch		10.16 mm			
Pol.	L1	(inch)	Qty.	Order No.	
2	10.16	0.400	50	1813570000	
3	20.32	0.800	50	1813580000	
4	30.48	1.200	50	1813590000	
5	40.64	1.600	20	1813600000	
6	50.80	2.000	20	1813610000	
7	60.96	2.400	20	1813620000	
8	71.12	2.800	20	1813630000	
9	81.28	3.200	20	1813640000	

Ordering data

Solder pin length		3.5 mm			
Colour		Black			
Pitch		10.16 mm			
Pol.	L1	(inch)	Qty.	Order No.	
2	10.16	0.400	50	1851040000	
3	20.32	0.800	50	1851050000	
4	30.48	1.200	50	1851060000	
5	40.64	1.600	20	1851070000	
6	50.80	2.000	20	1851080000	
7	60.96	2.400	20	1851090000	
8	71.12	2.800	20	1851100000	
9	81.28	3.200	20	1851110000	

Connectors in 10.16 mm pitch
Series BU/SU 10.16 – connects up to 16 mm²

SU 10.16HP/././180

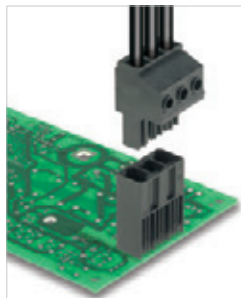

Male header in 180° outlet direction for TNC (S) systems. UL approved for 600 V in accordance with UL508 / UL840. The mating profile ensures touch-safety of more than 3 mm according to IEC 61800-5-1. Maximum operational reliability with a derating up to 125 °C, a mating profile that can only be plugged in correct and unique coding capability.

- Available with a flange (F) and screw flange (SF).

Product data

IEC: 1000 V / 74 A
 UL: 300 V / 54 A

For additional articles and information, refer to catalog.weidmueller.com

Note:

- Additional colours on request
- Rated current related to rated cross-section & min. No. of poles.
- The data given under CSA relates to a cUL approval - E60693
- P on drawing = pitch
- Rated data refer only to the component itself. Clearance and creepage distances to other components are to be designed in accordance with the relevant application standards.

SU 10.16HP/././180G

without flanges



Dimensioned drawing

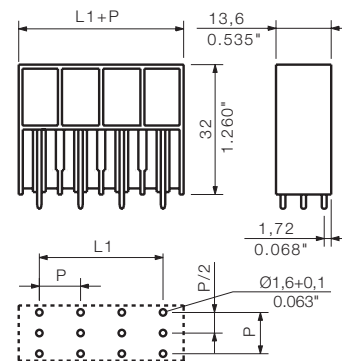



Technical data

In compliance with IEC 60664-1 / IEC 61984			
Clamping range, max.	mm ²		
Solid core H05(07) V-U	mm²		
Stranded H07 V-R			
Flexible H05(07) V-K	mm ²		
Flexible with ferrule	mm ²		
Ferrule with plastic collar	mm ²		
Stripping length	mm		
Screwdriver blade	mm		
According to norm			
Tightening torque range	Nm		
Rated current, max.	A	74	68
At ambient temperature		20°C	40°C
For conductor cross-section	mm ²		
Overvoltage category		III	III II
Pollution severity		3	2 2
Rated voltage	V	690	1000 1000
Rated impulse voltage	kV	8	8 6
UL / CUL (Use Group)		B	C D
Rated voltage	V	300	300 600
Rated current	A	54	54 5
AWG conductor	AWG		-
CSA (Use Group)		B	C D
Rated voltage	V	300	300 600
Rated current	A	54	54 5
AWG conductor	AWG		-
General data			
Type of insulation material		PBT GF	
UL 94 flammability rating		V-0	
Contact base material		Copper alloy	
Material of contact surface		silver-plated	
Pin dimensions = d	mm	1.2 x 1.1	
Solder eyelet Ø = D	mm	1.6	
Solder eyelet Ø tolerance	mm	+ 0,1	

Accessories

Note: Refer to the Accessories chapter for additional accessories.

Protection against twisting		Order No.
	VDS180 SV7.62	1853940000
Coding		
	KO BV/SV7.62	1824410000

Ordering data

Solder pin length		3.5 mm		
Colour		Black		
Pitch 10.16 mm				
Pol.	L1	(inch)	Qty.	Order No.
2	10.16	0.400	50	1813410000
3	20.32	0.800	50	1813420000
4	30.48	1.200	50	1813430000
5	40.64	1.600	20	1813440000
6	50.80	2.000	20	1813450000
7	60.96	2.400	20	1813460000
8	71.12	2.800	20	1813470000
9	81.28	3.200	20	1813480000

SU 10.16HP../180F

Interlock flanges



SU 10.16HP../180SF

Interlock flanges with nuts



Dimensioned drawing

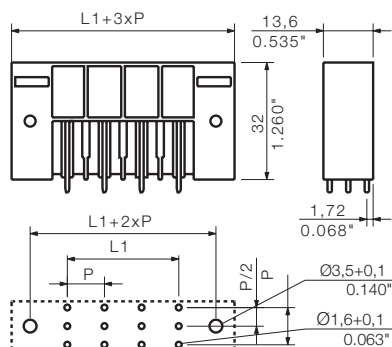

Dimensioned drawing

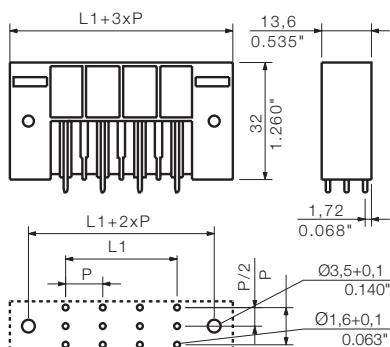

Ordering data

Solder pin length		3.5 mm			
Colour		Black			
Pitch		10.16 mm			
Pol.	L1	(inch)	Qty.	Order No.	
2	10.16	0.400	50	1813650000	
3	20.32	0.800	50	1813660000	
4	30.48	1.200	50	1813670000	
5	40.64	1.600	20	1813680000	
6	50.80	2.000	20	1813690000	
7	60.96	2.400	20	1813700000	
8	71.12	2.800	20	1813710000	
9	81.28	3.200	20	1813720000	

Ordering data

Solder pin length		3.5 mm			
Colour		Black			
Pitch		10.16 mm			
Pol.	L1	(inch)	Qty.	Order No.	
2	10.16	0.400	50	1850880000	
3	20.32	0.800	50	1850890000	
4	30.48	1.200	50	1850900000	
5	40.64	1.600	20	1850910000	
6	50.80	2.000	20	1850920000	
7	60.96	2.400	20	1850930000	
8	71.12	2.800	20	1850940000	
9	81.28	3.200	20	1850950000	

Connectors in 10.16 mm pitch
Series BU/SU 10.16 – connects up to 16 mm²

SU 10.16HP/./270

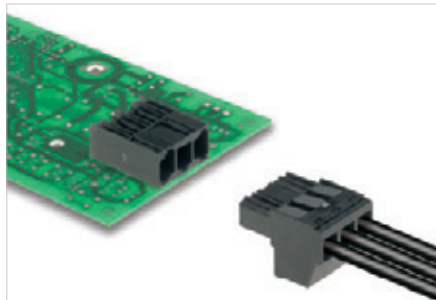

Male header in 270° outlet direction for TNC (S) systems. UL approved for 600 V in accordance with UL508 / UL840. The mating profile ensures touch-safety of more than 3 mm according to IEC 61800-5-1. Maximum operational reliability with a derating up to 125 °C, a mating profile that can only be plugged in correct and unique coding capability.

- Available with a flange (F) and screw flange (SF).

Product data

IEC: 1000 V / 76 A
 UL: 300 V / 54 A

For additional articles and information, refer to catalog.weidmueller.com

Note:

- Additional colours on request
- Rated current related to rated cross-section & min. No. of poles.
- The data given under CSA relates to a cUL approval - E60693
- P on drawing = pitch
- Rated data refer only to the component itself. Clearance and creepage distances to other components are to be designed in accordance with the relevant application standards.

SU 10.16HP/./270G

without flanges



Dimensioned drawing

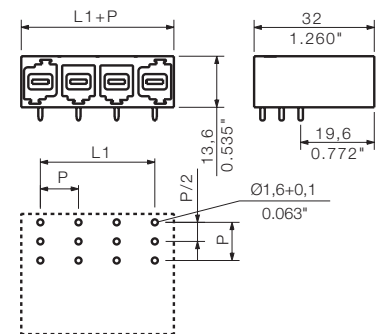

Technical data

In compliance with IEC 60664-1 / IEC 61984			
Clamping range, max.	mm ²		
Solid core H05(07) V-U	mm²		
Stranded H07 V-R			
Flexible H05(07) V-K	mm ²		
Flexible with ferrule	mm ²		
Ferrule with plastic collar	mm ²		
Stripping length	mm		
Screwdriver blade	mm		
According to norm			
Tightening torque range	Nm		
Rated current, max.	A	76	72
At ambient temperature		20°C	40°C
For conductor cross-section	mm ²		
Overvoltage category		III	III II
Pollution severity		3	2 2
Rated voltage	V	690	1000 1000
Rated impulse voltage	kV	8	8 6
UL / CUL (Use Group)	B C D		
Rated voltage	V	300	300 600
Rated current	A	54	54 5
AWG conductor	AWG		-
CSA (Use Group)	B C D		
Rated voltage	V	300	300 600
Rated current	A	54	54 5
AWG conductor	AWG		-
General data			
Type of insulation material		PBT GF	
UL 94 flammability rating		V-0	
Contact base material		Copper alloy	
Material of contact surface		silver-plated	
Pin dimensions = d	mm	1.2 x 1.1	
Solder eyelet Ø = D	mm	1.6	
Solder eyelet Ø tolerance	mm	+ 0,1	

Accessories

Note: Refer to the Accessories chapter for additional accessories.

Coding	Order No.
 KO BV/SV.7.62	1824410000

Ordering data

Solder pin length		3.5 mm		
Colour		Black		
Pitch 10.16 mm				
Pol.	L1	(inch)	Qty.	Order No.
2	10.16	0.400	50	1813490000
3	20.32	0.800	50	1813500000
4	30.48	1.200	50	1813510000
5	40.64	1.600	20	1813520000
6	50.80	2.000	20	1813530000
7	60.96	2.400	20	1813540000
8	71.12	2.800	20	1813550000
9	81.28	3.200	20	1813560000

SU 10.16HP../270F

Interlock flanges



SU 10.16HP../270SF

Interlock flanges with nuts



Dimensioned drawing

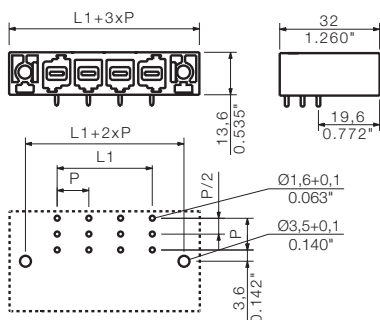

Dimensioned drawing

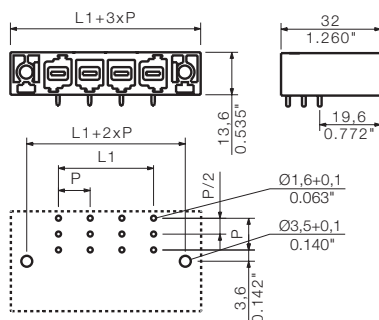

Ordering data

Solder pin length		3.5 mm			
Colour		Black			
Pitch		10.16 mm			
Pol.	L1	(inch)	Qty.	Order No.	
2	10.16	0.400	50	1813730000	
3	20.32	0.800	50	1813740000	
4	30.48	1.200	50	1813750000	
5	40.64	1.600	20	1813760000	
6	50.80	2.000	20	1813770000	
7	60.96	2.400	20	1813780000	
8	71.12	2.800	20	1813790000	
9	81.28	3.200	20	1813800000	

Ordering data

Solder pin length		3.5 mm			
Colour		Black			
Pitch		10.16 mm			
Pol.	L1	(inch)	Qty.	Order No.	
2	10.16	0.400	50	1851120000	
3	20.32	0.800	50	1851130000	
4	30.48	1.200	50	1851140000	
5	40.64	1.600	20	1851150000	
6	50.80	2.000	20	1851160000	
7	60.96	2.400	20	1851170000	
8	71.12	2.800	20	1851180000	
9	81.28	3.200	20	1851190000	

SUZ 10.16HP../180



Male plug in 180° outlet direction with clamping yoke screw connection for TNC (S) systems. Meets the requirements of UL1059 for 600 V Use Group C. The mating profile ensures touch safety of more than 3 mm according to IEC 61800-5-1 when connected.

Maximum operational reliability with a derating up to 125 °C, a mating profile that can only be plugged in correct and unique coding capability.

- Available with a flange (F) and screw flange on request.

Product data

IEC: 1000 V / 78 A / 0.2 - 16 mm²
UL: 600 V / 54 A / AWG 24 - 6

For additional articles and information, refer to catalog.weidmueller.com

Note:

- Additional colours on request
- Rated current related to rated cross-section & min. No. of poles.
- Wire end ferrule without plastic collar to DIN 46228/1
- Wire end ferrule with plastic collar to DIN 46228/4
- P on drawing = pitch
- Rated data refer only to the component itself. Clearance and creepage distances to other components are to be designed in accordance with the relevant application standards.

SUZ 10.16HP../180G



Dimensioned drawing

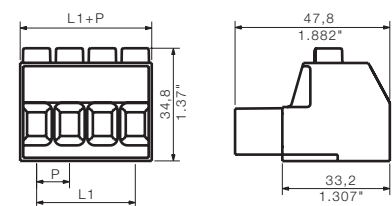

Technical data

In compliance with IEC 60664-1 / IEC 61984			
Clamping range, max.	mm ²	0.2...16	
Solid core H05(07) V-U	mm²	0.2...16	
Stranded H07 V-R		6...16	
Flexible H05(07) V-K	mm ²	0.5...16	
Flexible with ferrule	mm ²	0.25...16	
Ferrule with plastic collar	mm ²	0.25...10	
Stripping length	mm	12	
Screwdriver blade	mm	1.0 x 5.5	
According to norm		DIN 5264	
Tightening torque range	Nm	1.2...1.5	
Rated current, max.	A	78	72
At ambient temperature		20°C	40°C
For conductor cross-section	mm ²	16	
Overvoltage category		III	III II
Pollution severity		3	2 2
Rated voltage	V	1000	1000 1000
Rated impulse voltage	kV	8	8 6
UL / CUL (Use Group)	B C D		
Rated voltage	V	600	600 600
Rated current	A	54	54 5
AWG conductor	AWG		24-6
CSA (Use Group)	B C D		
Rated voltage	V	600	600 600
Rated current	A	54	54 5
AWG conductor	AWG	24-6	
General data			
Type of insulation material		PA GF	
UL 94 flammability rating		V-0	
Contact base material		Copper alloy	
Material of contact surface		silver-plated	
Pin dimensions = d	mm		
Solder eyelet Ø = D	mm		
Solder eyelet Ø tolerance	mm		

Accessories

Note: Refer to the Accessories chapter for additional accessories.

Coding		Order No.
	KO BV/SV7.62	1824410000
Screwdriver		
	SDIS 1.0X5.5X125	9008410000
Crosshead screwdriver		
	SDIK PZZ	9008890000
	SDK PZZ	9008540000

Ordering data

Solder pin length					
Colour	Black				
Pitch	10.16 mm				
Pol.	L1	(inch)	Qty.	Order No.	
2	10.16	0.400	50	1947480000	
3	20.32	0.800	50	1947490000	
4	30.48	1.200	50	1947500000	
5	40.64	1.600	20	1947510000	
6	50.80	2.000	20	1966920000	
7	60.96	2.400	20	1966930000	
8	71.12	2.800	20	1962400000	
9	81.28	3.200	20	1966910000	

Representative deratings curve

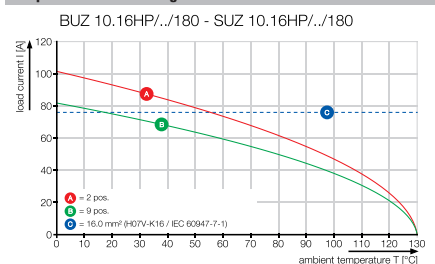

Connectors in 10.16 mm pitch
Series BU/SU 10.16 – connects up to 16 mm²

BUZ 10.16HP/./180

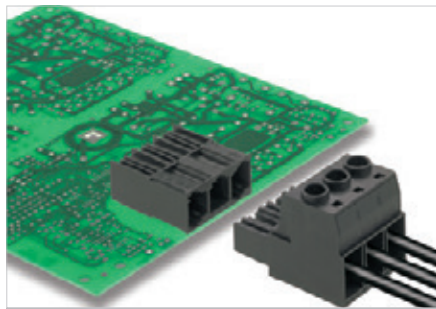

Female plug in 180° outlet direction with clamping yoke screw connection for TNC (S) systems. Meets the requirements of UL1059 for 600 V Use Group C. Ensures touch-safety of > 3 mm in accordance with IEC 61800-5-1.

Maximum operational reliability with a derating up to 125 °C, a mating profile that can only be plugged in correct and unique coding capability.

- Available with a flange (F) and screw flange (SF).

Product data

IEC: 1000 V / 78 A / 0.2 - 16 mm²
 UL: 600 V / 54 A / AWG 22 - 6

For additional articles and information, refer to catalog.weidmueller.com

Note:

- Additional colours on request
- Rated current related to rated cross-section & min. No. of poles.
- Wire end ferrule without plastic collar to DIN 46228/1
- Wire end ferrule with plastic collar to DIN 46228/4
- P on drawing = pitch
- Rated data refer only to the component itself. Clearance and creepage distances to other components are to be designed in accordance with the relevant application standards.

BUZ 10.16HP/./180



Dimensioned drawing

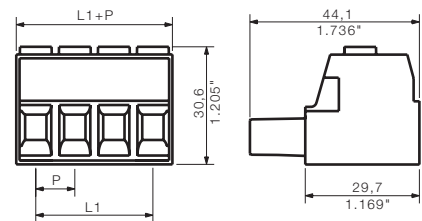

Technical data

In compliance with IEC 60664-1 / IEC 61984			
Clamping range, max.	mm ²	0.2...16	
Solid core H05(07) V-U	mm²	0.2...16	
Stranded H07 V-R		6...16	
Flexible H05(07) V-K	mm ²	0.5...16	
Flexible with ferrule	mm ²	0.25...16	
Ferrule with plastic collar	mm ²	0.25...10	
Stripping length	mm	12	
Screwdriver blade	mm	1.0 x 5.5	
According to norm		DIN 5264	
Tightening torque range	Nm	1.2...1.5	
Rated current, max.	A	78	72
At ambient temperature		20°C	40°C
For conductor cross-section	mm ²	16	
Overvoltage category		III	III II
Pollution severity		3	2 2
Rated voltage	V	1000	1000 1000
Rated impulse voltage	kV	8	8 6
UL / CUL (Use Group)	B C D		
Rated voltage	V	600	600 600
Rated current	A	54	54 5
AWG conductor	AWG	22-6	
CSA (Use Group)	B C D		
Rated voltage	V	600	600 600
Rated current	A	54	54 5
AWG conductor	AWG	22-6	
General data			
Type of insulation material		PA GF	
UL 94 flammability rating		V-0	
Contact base material		Copper alloy	
Material of contact surface		silver-plated	
Pin dimensions = d	mm		
Solder eyelet Ø = D	mm		
Solder eyelet Ø tolerance	mm		

Accessories

Note: Refer to the Accessories chapter for additional accessories.

Coding		Order No.
	KO BV/SV7.62	1824410000
Screwdriver		
	SDIS 1.0X5.5X125	9008410000
Crosshead screwdriver		
	SDIK PZ2	9008890000
	SDK PZ2	9008540000

Ordering data

Solder pin length					
Colour	Black				
Pitch	10.16 mm				
Pol.	L1	(inch)	Qty.	Order No.	
2	10.16	0.400	50	1924540000	
3	20.32	0.800	50	1924550000	
4	30.48	1.200	50	1924560000	
5	40.64	1.600	20	1924570000	
6	50.80	2.000	20	1924580000	
7	60.96	2.400	20	1924590000	
8	71.12	2.800	20	1924600000	
9	81.28	3.200	20	1924610000	

Representative deratings curve

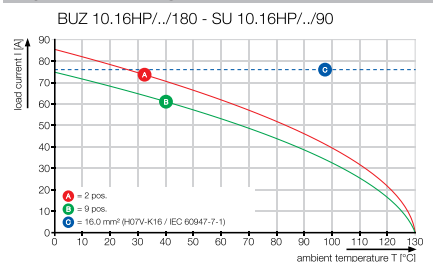

BUZ 10.16HP../180F



BUZ 10.16HP../180SF



Dimensioned drawing

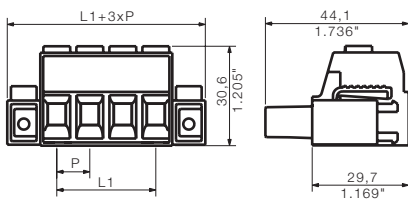

Dimensioned drawing

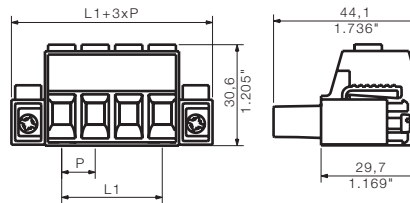

Ordering data

Solder pin length					
Colour					Black
Pitch 10.16 mm					
Pol.	L1	(inch)	Qty.	Order No.	
2	10.16	0.400	50	1924620000	
3	20.32	0.800	50	1924630000	
4	30.48	1.200	20	1924640000	
5	40.64	1.600	20	1924650000	
6	50.80	2.000	20	1924660000	
7	60.96	2.400	20	1924670000	
8	71.12	2.800	20	1924680000	
9	81.28	3.200	20	1924690000	

Ordering data

Solder pin length					
Colour					Black
Pitch 10.16 mm					
Pol.	L1	(inch)	Qty.	Order No.	
2	10.16	0.400	50	1924700000	
3	20.32	0.800	50	1924710000	
4	30.48	1.200	20	1924720000	
5	40.64	1.600	20	1924740000	
6	50.80	2.000	20	1924750000	
7	60.96	2.400	20	1924760000	
8	71.12	2.800	20	1924770000	
9	81.28	3.200	20	1924780000	

Additional deratings curves

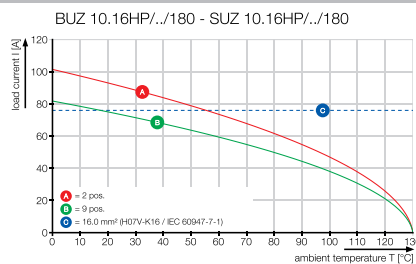
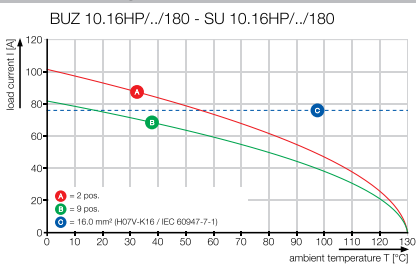

Connectors in 10.16 mm pitch
Series BU/SU 10.16 – connects up to 16 mm²

BUL 10.16HP../180

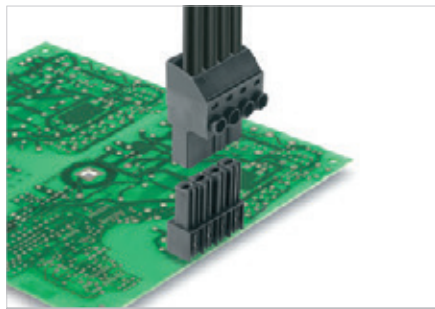

Finger-safe female header with 180° outlet direction for PCBs. Meets the requirements of IEC 61800-5-1 and allows UL approval in accordance with UL508 / UL840 for 600 V. An ideal finger-safe solution for power output and DC-link applications. The pin arrangement is finger-safe. The assembly coding ensures that it cannot be assembled on the PCB turned through 180°.

Features:

- Derating up to 130 °C, 100 %
- Pin arrangement that prevents wrong connections or wrong wiring
- Unique coding diversity and assembly coding

Technical data

In compliance with IEC 60664-1 / IEC 61984			
Clamping range, max.	mm ²		
Solid core H05(07) V-U	mm²		
Stranded H07 V-R			
Flexible H05(07) V-K	mm ²		
Flexible with ferrule	mm ²		
Ferrule with plastic collar	mm ²		
Stripping length	mm		
Screwdriver blade	mm		
According to norm			
Tightening torque range	Nm		
Rated current, max.	A	76	69
At ambient temperature		20°C	40°C
For conductor cross-section	mm ²		
Overtoltage category		III	III II
Pollution severity		3	2 2
Rated voltage	V	630	630 1000
Rated impulse voltage	kV	6	6 6
UL / CUL (Use Group)		B	C D
Rated voltage	V		
Rated current	A		
AWG conductor	AWG		
CSA (Use Group)		B	C D
Rated voltage	V		
Rated current	A		
AWG conductor	AWG		
General data			
Type of insulation material		PA GF	
UL 94 flammability rating		V-0	
Contact base material		Copper alloy	
Material of contact surface		silver-plated	
Pin dimensions = d	mm	0.8 x 1.0	
Solder eyelet Ø = D	mm	1.3	
Solder eyelet Ø tolerance	mm	+ 0,1	

Product data

IEC: 1000 V / 76 A

UL:

For additional articles and information, refer to catalog.weidmueller.com

Note:

- Additional colours on request
- Rated current related to rated cross-section & min. No. of poles.
- P on drawing = pitch
- Rated data refer only to the component itself. Clearance and creepage distances to other components are to be designed in accordance with the relevant application standards.

BUL 10.16HP../180

Without flange



Dimensioned drawing

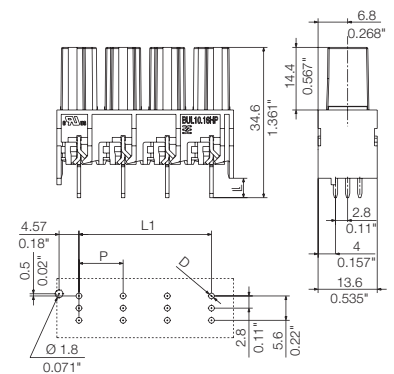

Ordering data

Solder pin length		4.5 mm	
Colour		Black	
Pitch 10.16 mm			
Pol.	L1	(inch)	Qty. Order No.
2	10.16	0.400	50 1289000000
2	10.16	0.400	50 1341270000
4	10.16	0.400	50 1289010000

Accessories

Note: Refer to the Accessories chapter for additional accessories.

Coding		Order No.
	KO BV/SV7.62	1824410000

Representative deratings curve

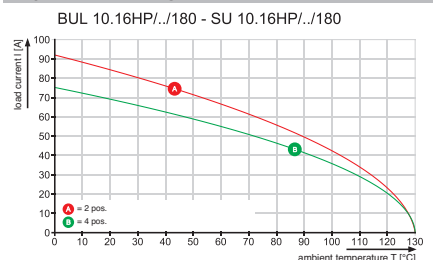

OMNIMATE Power for IT systems – scalable up to 50 kVA

Custom-fit solutions for special requirements

Increased compliance with standards and fewer compromises: OMNIMATE Power for IT systems establishes a new level of excellence with its standard integrated details. These attributes streamline the design-in and approval processes and result in safer operations.

Results for the application and advantages for the user: unlimited use in 400-V IT systems and touch safety according to IEC 61800-5-1 (+ 5 mm). The self-snapping one-handed safety flange enables intuitive and safe usage. Operational reliability is guaranteed by the automatic interlock feature during the plug-in process. The application-oriented design means that no compromises are necessary during the approval process.

F

Uncompromised scalability

As much power as required, as little cost as needed: a device series for every power level and power type: scalable from 25 A/2.5 mm² to 41 A/6 mm² to 76 A/16 mm².



IEC 61800-5-1 approval

No additional measures or compromises in the system suitable, touch-safe certification according to IEC 61800-5-1:
+ 3.0 mm for 400 V TN systems,
+ 5.5 mm for 400 V IT networks.

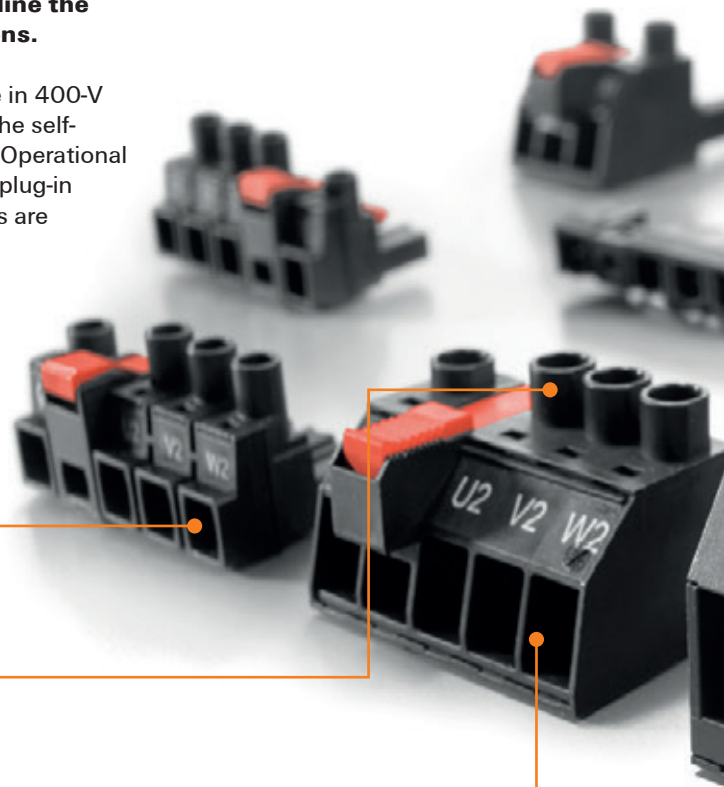
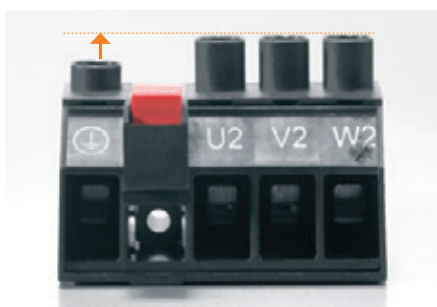

Uncompromised power capabilities

Uncompromised means high power reserves for superior overload capacity even under the high ambient temperatures of real-world applications.

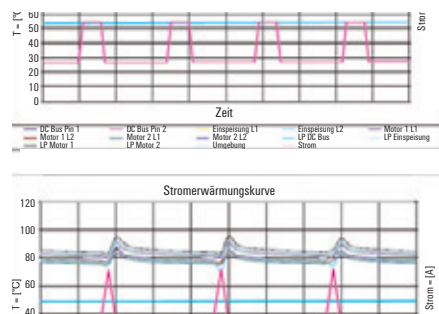

Uncompromised safety

Details such as insulated contact tips that ensure the pin header is touch-safe and automatic snap-in for a secure interlocking connection.

**Finger safety according to DIN EN 61800-5-1**

Since the end of 2007, device approval according to IEC Directive "Adjustable speed electrical power drive systems – Part 5-1: Safety requirements" requires that – regardless of the line-to-earth voltage – an additional finger safety interval exists (for example, + 3 mm for 400 V-TN systems (wire-to-earth voltage = 230 V), or + 5.5 mm for 400-V IT systems (wire-to-earth voltage up to 400 V in event of error)). An additional cover is required if the connection system, as a device section, does not fulfil these requirements. The OMNIMATE Power HP product line already complies with the stricter IEC requirements for additional touch protection.

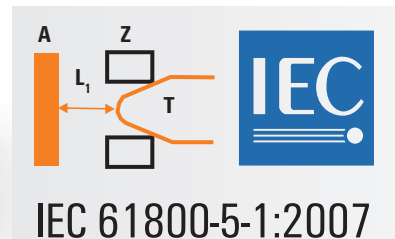
**Clearance and creepage distances, acc. to UL**



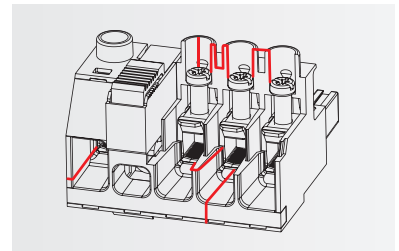

A 600-V connector must have the approval of the UL 1059 component directive – but the potential installation situations must first be taken into consideration. This allows you to avoid making approval compromises – such as UL 508C or incorporating complex additions such as coatings or protective hoods. The OMNIMATE Power HP product line already complies with the UL requirements for 600-V creepage and clearance distances.

**UL approval without compromise**

No limitation for UL approval with 600-V applications: with optimised creepage and clearance distance even under difficult installation situations.

600 V

<http://www.OMNIMATE.net>

-  = Wire-to-Board
-  = Board-to-Board
-  = Wire-to-Wire
-  = Board-to-Wire

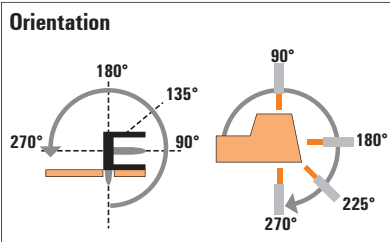
Grids 7.62 mm



For IT networks















Type	SL	SL
Orientation	90°	90°
Flange options	MF2	MF3
Product code numbers	IEC: 800 V/24 A UL: 300 V/20 A	IEC: 800 V/24 A UL: 300 V/20 A
Page	F.96	F.97



Screw Clamping yoke

Female plug

	BLZ	180°	MF2	IEC: 800 V/24 A/0.08 - 4 mm ² UL: 300 V/20 A/AWG 28 - 12	F.98	 	
	BLZ	180°	MF3	IEC: 800 V/24 A/0.08 - 4 mm ² UL: 300 V/20 A/AWG 28 - 12	F.99		 
	BLZ	180°	MF4	IEC: 800 V/24 A/0.08 - 4 mm ² UL: 300 V/20 A/AWG 28 - 12	F.99		
	BVZ	180°	MF2	IEC: 1.000 V/41 A/0.2 - 6 mm ² UL: 300 V/35 A/AWG 24 - 10	F.104		
	BVZ	180°	MF3	IEC: 1.000 V/41 A/0.2 - 6 mm ² UL: 300 V/35 A/AWG 24 - 10	F.105		
	BVZ	180°	MF4	IEC: 1.000 V/41 A/0.2 - 6 mm ² UL: 300 V/35 A/AWG 24 - 10	F.105		
	BUZ	180°	MF2	IEC: 1.000 V/76 A/0.2 - 16 mm ² UL: 300 V/54 A/AWG 22 - 6	F.110		
	BUZ	180°	MF3	IEC: 1.000 V/76 A/0.2 - 16 mm ² UL: 300 V/54 A/AWG 22 - 6	F.111		
	BUZ	180°	MF4	IEC: 1.000 V/76 A/0.2 - 16 mm ² UL: 300 V/54 A/AWG 22 - 6	F.111		

MF2 = Centre snap flange at position 2
MF3 = Centre snap flange at position 3
MF4 = Centre snap flange at position 4

Male header



Solder connection

Grids 7.62 mm

Grids 10.16 mm



	SL	SV	SV	SV	SU	SU	SU
	90°	90° / 270°	90° / 270°	90° / 270°	90° / 270°	90° / 270°	90° / 270°
	MF4	MF2	MF3	MF4	MF2	MF3	MF4
	IEC: 800 V/24 A UL: 300 V/20 A	IEC: 1.000 V/41 A UL: 300 V/35 A	IEC: 1.000 V/41 A UL: 300 V/35 A	IEC: 1.000 V/41 A UL: 300 V/35 A	IEC: 1.000 V/76 A UL: 300 V/54 A	IEC: 1.000 V/76 A UL: 300 V/54 A	IEC: 1.000 V/76 A UL: 300 V/54 A
	F.97	F.100	F.101	F.101	F.106	F.107	F.107
	○ ●						
		○ ●					
			○ ●				
				○ ●			
					○ ●		
						○ ●	
							○ ●

F

Connectors for IT systems in 7.62 mm pitch
Series BL/SL 7.62 IT – connects up to 4 mm²

SL 7.62IT/./90MF

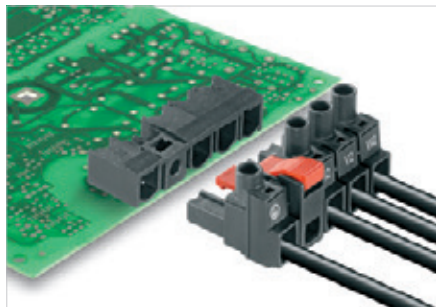

Male header available in 90° outlet direction with a leading PE contact for IT networks. UL approval according to UL840 (600 V). Used together with the BLZ 7.62 IT female plug. It complies with the expanded requirements for 5.5 mm of touch protection (400 V relative to earth), according to IEC 61800-5-1. When no female plug is present, the mating profile ensures at least 1 mm of finger protection with a test finger pressure of 20N.

The middle flange interlock feature decreases the space required by one pole when compared to other solutions.

Available on request with screw flange mounting block or without flange.

Product data

IEC: 630 V / 29 A
 UL: 300 V / 20 A

For additional articles and information, refer to catalog.weidmueller.com

Note:

- Additional colours on request
- Gold-plated contact surfaces on request
- Rated current related to rated cross-section & min. No. of poles.
- P on drawing = pitch
- Rated data refer only to the component itself. Clearance and creepage distances to other components are to be designed in accordance with the relevant application standards.

SL 7.62IT/./90MF2



Dimensioned drawing

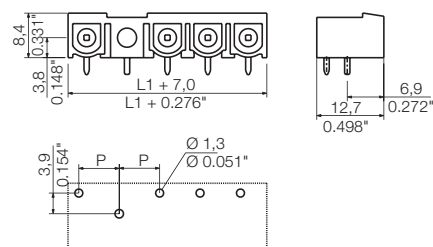

Technical data

In compliance with IEC 60664-1 / IEC 61984			
Clamping range, max.	mm ²		
Solid core H05(07) V-U	mm²		
Stranded H07 V-R			
Flexible H05(07) V-K	mm ²		
Flexible with ferrule	mm ²		
Ferrule with plastic collar	mm ²		
Stripping length	mm		
Screwdriver blade	mm		
According to norm			
Tightening torque range	Nm		
Rated current, max.	A	29	25
At ambient temperature		20°C	40°C
For conductor cross-section	mm ²		
Overtoltage category		III	III II
Pollution severity		3	2 2
Rated voltage	V	400	500 630
Rated impulse voltage	kV	6	6 6
UL / CUL (Use Group)		B	C D
Rated voltage	V	300	300 600
Rated current	A	20	20 5
AWG conductor	AWG		-
CSA (Use Group)		B	C D
Rated voltage	V	300	300 600
Rated current	A	20	20 5
AWG conductor	AWG		-
General data			
Type of insulation material		PBT GF	
UL 94 flammability rating		V-0	
Contact base material		Copper alloy	
Material of contact surface		tinned	
Pin dimensions = d	mm	1.0 x 1.0	
Solder eyelet Ø = D	mm	1.3	
Solder eyelet Ø tolerance	mm	+ 0,1	

Accessories

Note: Refer to the Accessories chapter for additional accessories.

Coding	Order No.
BLZ/SL KO OR	1573010000
BLZ/SL KO SW	1545710000

Ordering data

Solder pin length		3.2 mm		
Colour		Black		
Pitch		7.62 mm		
Pol.	L1	(inch)	Qty.	Order No.
2	15.24	0.600	100	1173610000
3	22.86	0.900	100	1173640000
4	30.48	1.200	100	1173730000

SL 7.62IT../90MF3



Dimensioned drawing

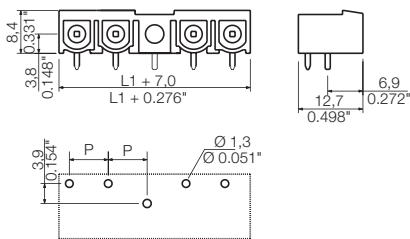

Ordering data

Solder pin length		3.2 mm		
Colour		Black		
Pitch		7.62 mm		
Pol.	L1	(inch)	Qty.	Order No.
3	22.86	0.900	100	1173690000

SL 7.62IT../90MF4



Dimensioned drawing

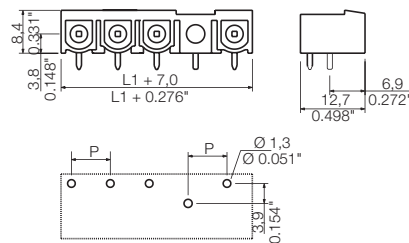

Ordering data

Solder pin length		3.2 mm		
Colour		Black		
Pitch		7.62 mm		
Pol.	L1	(inch)	Qty.	Order No.
4	30.48	1.200	100	1173770000

Connectors for IT systems in 7.62 mm pitch
Series BL/SL 7.62 IT – connects up to 4 mm²

BLZ 7.62IT../180MF

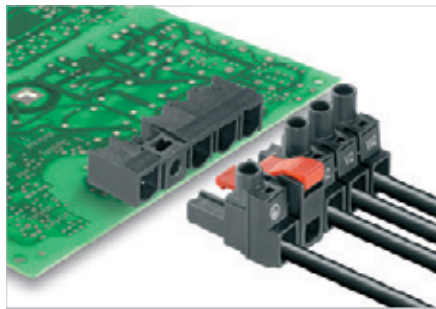

Female plug in 180° outlet direction for IT networks. Fulfills the requirements of UL1059 600 V Class C. With a leading PE contact when used with SL 7.62 IT male header. Fulfills the expanded requirements for 5.5 mm of touch protection (400 V relative to earth), according to IEC 61800-5-1.

The middle flange interlocks automatically and is optionally available with screw connection. It decreases the space required by one pole when compared to other solutions.

Available optionally without middle flange interlock.

Product data

IEC: 630 V / 29 A / 0.08 - 4 mm²
 UL: 600 V / 20 A / AWG 20 - 12

For additional articles and information, refer to catalog.weidmueller.com

Note:

- Additional colours on request
- Gold-plated contact surfaces on request
- Rated current related to rated cross-section & min. No. of poles.
- Wire end ferrule without plastic collar to DIN 46228/1
- Wire end ferrule with plastic collar to DIN 46228/4
- P on drawing = pitch
- Rated data refer only to the component itself. Clearance and creepage distances to other components are to be designed in accordance with the relevant application standards.

BLZ 7.62IT../180MF2



Dimensioned drawing

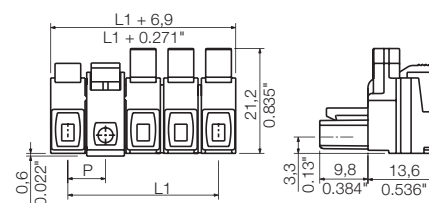



Technical data

In compliance with IEC 60664-1 / IEC 61984		
Clamping range, max.	mm ²	0.08...4
Solid core H05(07) V-U	mm²	0.08...4
Stranded H07 V-R		
Flexible H05(07) V-K	mm ²	0.08...4
Flexible with ferrule	mm ²	0.2...2.5
Ferrule with plastic collar	mm ²	0.2...2.5
Stripping length	mm	7
Screwdriver blade	mm	0.6 x 3.5
According to norm		DIN 5264
Tightening torque range	Nm	0.4...0.5
Rated current, max.	A	29 25
At ambient temperature		20°C 40°C
For conductor cross-section	mm ²	2.5
Overtoltage category		III III II
Pollution severity		3 2 2
Rated voltage	V	400 500 630
Rated impulse voltage	kV	6 6 4
UL / CUL (Use Group)	B C D	
Rated voltage	V	600 600 600
Rated current	A	20 20 5
AWG conductor	AWG	20-12
CSA (Use Group)	B C D	
Rated voltage	V	600 600 600
Rated current	A	20 20 5
AWG conductor	AWG	20-12
General data		
Type of insulation material		PBT
UL 94 flammability rating		V-0
Contact base material		Copper alloy
Material of contact surface		tinned
Pin dimensions = d	mm	
Solder eyelet Ø = D	mm	
Solder eyelet Ø tolerance	mm	

Accessories

Note: Refer to the Accessories chapter for additional accessories.

Coding		Order No.
	BLZ/SL KO OR	1573010000
	BLZ/SL KO SW	1545710000
Screwdriver		
	SDIS 0.6X3.5X100	9008390000
	SDS 0.6X3.5X100	9008330000

Ordering data

Solder pin length					
Colour	Black				
Pitch	7.62 mm				
Pol.	L1	(inch)	Qty.	Order No.	
2	15.24	0.600	65	1173490000	
3	22.86	0.900	50	1173500000	
4	30.48	1.200	40	1173520000	

Representative deratings curve

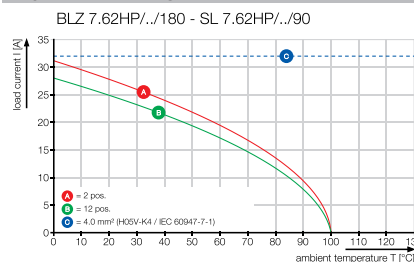

BLZ 7.62IT../180MF3



BLZ 7.62IT../180MF4



Dimensioned drawing

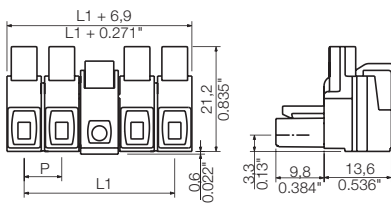

Dimensioned drawing

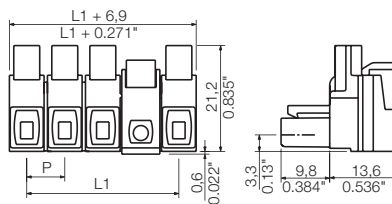

Ordering data

Solder pin length				
Colour	Black			
Pitch	7.62 mm			
Pol.	L1	(inch)	Qty.	Order No.
3	22.86	0.900	50	1173510000

Ordering data

Solder pin length				
Colour	Black			
Pitch	7.62 mm			
Pol.	L1	(inch)	Qty.	Order No.
4	30.48	1.200	40	1173530000

Additional deratings curves

BLZ 7.62HP../180 - SL 7.62HP../90

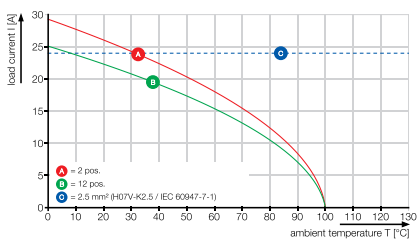

SV 7.62IT/./90MF

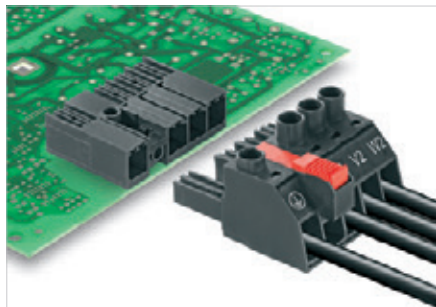

Male header in 90° outlet direction with a leading PE contact for IT networks. UL approval according to UL840 for 600 V. Used together with a BVZ 7.62 IT female plug. It complies with the expanded requirements for 5.5 mm of touch protection (400 V relative to earth), according to IEC 61800-5-1. When no female plug is present, the mating profile ensures at least 1 mm of finger protection with a test finger pressure of 20N.

The middle flange interlock feature decreases the space required by one pole when compared to other solutions.

Available on request with screw flange mounting block or without flange.

Product data

IEC: 1000 V / 41 A
UL: 300 V / 35 A

For additional articles and information, refer to catalog.weidmueller.com

Note:

- Additional colours on request
- Rated current related to rated cross-section & min. No. of poles.
- P on drawing = pitch
- Rated data refer only to the component itself. Clearance and creepage distances to other components are to be designed in accordance with the relevant application standards.

SV 7.62IT/./90MF2



Dimensioned drawing

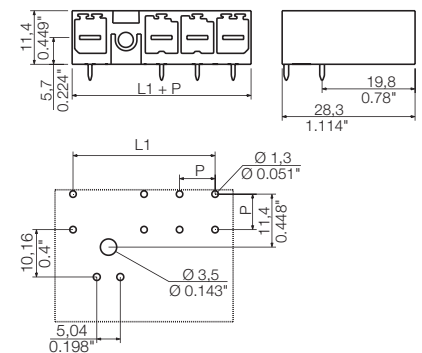

Technical data

In compliance with IEC 60664-1 / IEC 61984

Clamping range, max.	mm ²		
Solid core H05(07) V-U	mm²		
Stranded H07 V-R			
Flexible H05(07) V-K	mm ²		
Flexible with ferrule	mm ²		
Ferrule with plastic collar	mm ²		
Stripping length	mm		
Screwdriver blade	mm		
According to norm			
Tightening torque range	Nm		
Rated current, max.	A	41	41
At ambient temperature		20°C	40°C
For conductor cross-section	mm ²		
Overtoltage category		III	III II
Pollution severity		3	2 2
Rated voltage	V	630	630 1000
Rated impulse voltage	kV	6	6 6
UL / CUL (Use Group)		B	C D
Rated voltage	V	300	300 600
Rated current	A	35	35 5
AWG conductor	AWG		-
CSA (Use Group)		B	C D
Rated voltage	V	300	300 600
Rated current	A	35	35 5
AWG conductor	AWG		-
General data			
Type of insulation material		PA GF	
UL 94 flammability rating		V-0	
Contact base material		Copper alloy	
Material of contact surface		tinned	
Pin dimensions = d	mm	0.8 x 1.0	
Solder eyelet Ø = D	mm	1.3	
Solder eyelet Ø tolerance	mm	+ 0,1	

Accessories

Note: Refer to the Accessories chapter for additional accessories.

Coding	Order No.
 BV/SV 7.62HP K0	1937590000
Mounting foot	
BV/SV7.62HP MOFU GR	1937600000

Ordering data

Solder pin length		3.5 mm		
Colour		Black		
Pitch		7.62 mm		
Pol.	L1	(inch)	Qty.	Order No.
2	15.24	0.600	78	1156540000
3	22.86	0.900	60	1156550000
4	30.48	1.200	48	1156580000

SV 7.62IT../90MF3



SV 7.62IT../90MF4



Dimensioned drawing

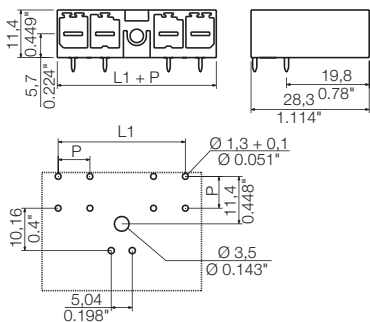

Dimensioned drawing

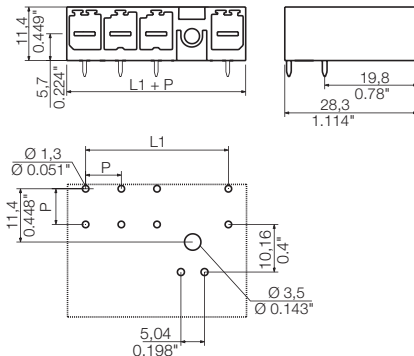

Ordering data

Solder pin length		3.5 mm	
Colour		Black	
Pitch		7.62 mm	
Pol.	L1	(inch)	Order No.
3	22.86	0.900	1156570000

Ordering data

Solder pin length		3.5 mm	
Colour		Black	
Pitch		7.62 mm	
Pol.	L1	(inch)	Order No.
4	30.48	1.200	1156590000



SV 7.62IT../270MF

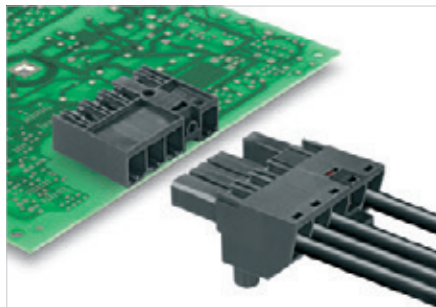

Male header in 270° outlet direction with a leading PE contact for IT networks. UL approval according to UL840 for 600 V. Used together with a BLZ 7.62 IT female plug, it complies with the expanded requirements for 5.5 mm of touch protection (400 V relative to earth), according to IEC 61800-5-1. When no female header is present, the mating profile ensures at least 1 mm of finger protection with a test finger pressure of 20 N.

The middle flange interlock feature decreases the space required by one pole when compared to other solutions.

Available on request with screw flange mounting block or without flange.

Product data

IEC: 1000 V / 41 A
UL: 300 V / 35 A

For additional articles and information, refer to catalog.weidmueller.com

Note:

- Additional colours on request
- Rated current related to rated cross-section & min. No. of poles.
- P on drawing = pitch
- Rated data refer only to the component itself. Clearance and creepage distances to other components are to be designed in accordance with the relevant application standards.

SV 7.62IT../270MF2



Dimensioned drawing

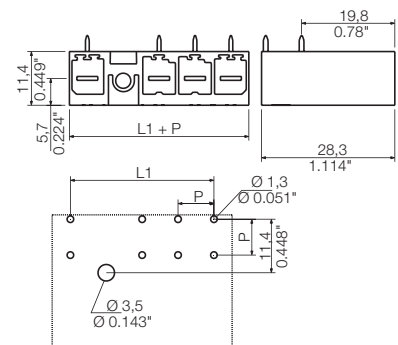

Technical data

In compliance with IEC 60664-1 / IEC 61984

Clamping range, max.	mm ²		
Solid core H05(07) V-U	mm²		
Stranded H07 V-R			
Flexible H05(07) V-K	mm ²		
Flexible with ferrule	mm ²		
Ferrule with plastic collar	mm ²		
Stripping length	mm		
Screwdriver blade	mm		
According to norm			
Tightening torque range	Nm		
Rated current, max.	A	41	41
At ambient temperature		20°C	40°C
For conductor cross-section	mm ²		
Overvoltage category		III	III II
Pollution severity		3	2 2
Rated voltage	V	630	630 1000
Rated impulse voltage	kV	6	6 6
UL / CUL (Use Group)		B	C D
Rated voltage	V	300	300 600
Rated current	A	35	35 5
AWG conductor	AWG		-
CSA (Use Group)		B	C D
Rated voltage	V	300	300 600
Rated current	A	35	35 5
AWG conductor	AWG		-
General data			
Type of insulation material		PA GF	
UL 94 flammability rating		V-0	
Contact base material		Copper alloy	
Material of contact surface		tinned	
Pin dimensions = d	mm	0.8 x 1.0	
Solder eyelet Ø = D	mm	1.3	
Solder eyelet Ø tolerance	mm	+ 0,1	

Accessories

Note: Refer to the Accessories chapter for additional accessories.

Coding	Order No.
 BV/SV 7.62HP KO	1937590000
Mounting foot	
BV/SV7.62HP MOFU GR	1937600000

Ordering data

Solder pin length		3.5 mm	
Colour		Black	
Pitch		7.62 mm	
Pol.	L1 (inch)	Qty.	Order No.
2	15.24	78	1156490000
3	22.86	60	1156500000
4	30.48	48	1156520000

SV 7.62IT/./270MF3



SV 7.62IT/./270MF4



Dimensioned drawing

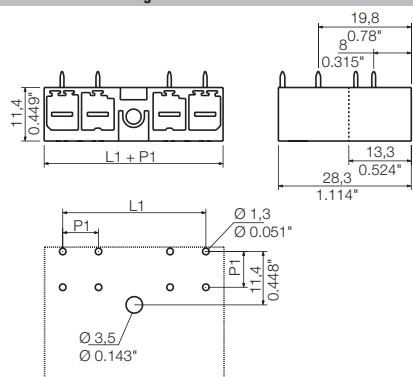

Dimensioned drawing

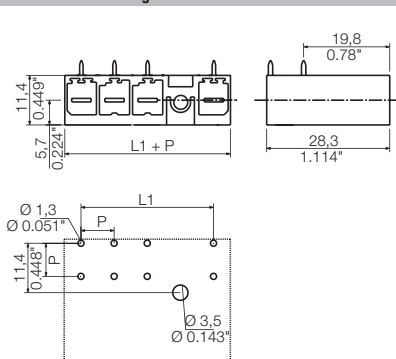

Ordering data

Solder pin length		3.5 mm		
Colour		Black		
Pitch		7.62 mm		
Pol.	L1	(inch)	Qty.	Order No.
3	22.86	0.900	60	1156510000

Ordering data

Solder pin length		3.5 mm		
Colour		Black		
Pitch		7.62 mm		
Pol.	L1	(inch)	Qty.	Order No.
4	30.48	1.200	48	1156530000

BVZ 7.62IT../180MF

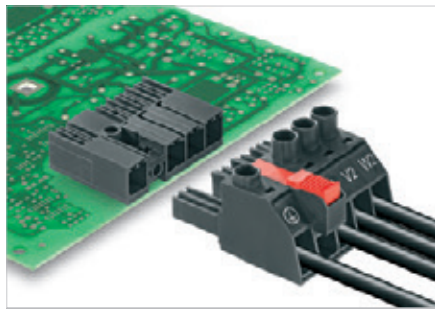

Female plug in 180° outlet direction for IT networks. Fulfils the requirements of UL1059 for 600 V Use Group C. With leading PE contact when used with SV 7.62 IT male header. Fulfils the expanded requirements for 5.5 mm of touch protection (400 V relative to earth), according to IEC 61800-5-1.

The middle flange interlocks automatically and is optionally available with screw connection. It decreases the space required by one pole when compared to other solutions.

Available optionally without middle flange interlock.

Product data

IEC: 1000 V / 41 A / 0.2 - 6 mm²
UL: 600 V / 35 A / AWG 24 - 10

For additional articles and information, refer to catalog.weidmueller.com

Note:

- Additional colours on request
- Rated current related to rated cross-section & min. No. of poles.
- Wire end ferrule without plastic collar to DIN 46228/1
- Wire end ferrule with plastic collar to DIN 46228/4
- P on drawing = pitch
- Rated data refer only to the component itself. Clearance and creepage distances to other components are to be designed in accordance with the relevant application standards.

BVZ 7.62IT../180MF2



Dimensioned drawing

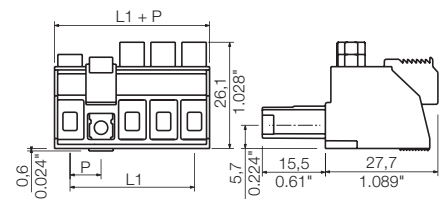

Technical data

In compliance with IEC 60664-1 / IEC 61984

Clamping range, max.	mm ²	0.2...6
Solid core H05(07) V-U	mm²	0.2...6
Stranded H07 V-R		
Flexible H05(07) V-K	mm ²	0.5...6
Flexible with ferrule	mm ²	0.25...6
Ferrule with plastic collar	mm ²	0.25...6
Stripping length	mm	12
Screwdriver blade	mm	0.8 x 4.5
According to norm		DIN 5264
Tightening torque range	Nm	0.5...0.6
Rated current, max.	A	41 41
At ambient temperature		20°C 40°C
For conductor cross-section	mm ²	6
Overvoltage category		III III II
Pollution severity		3 2 2
Rated voltage	V	800 1000 1000
Rated impulse voltage	kV	8 8 6
UL / CUL (Use Group)		B C D

Rated voltage	V	600 600 600
Rated current	A	35 35 5
AWG conductor	AWG	24-10
CSA (Use Group)		B C D
Rated voltage	V	600 600 600
Rated current	A	35 35 5
AWG conductor	AWG	24-10

General data

Type of insulation material		PA GF
UL 94 flammability rating		V-0
Contact base material		Copper alloy
Material of contact surface		tinned
Pin dimensions = d	mm	
Solder eyelet Ø = D	mm	
Solder eyelet Ø tolerance	mm	

Accessories

Note: Refer to the Accessories chapter for additional accessories.

Coding		Order No.
	BV/SV 7.62HP K0	1937590000
Strain relief		
	BV/SV 7.62HP/02 ZE GR	1937560000
	BV/SV 7.62HP/04 ZE GR	1937560000
Screwdriver		
	SDS 0.8x4.0x125	9009020000
Crosshead screwdriver		
	SDK PH1	9008480000

Ordering data

Solder pin length				
Colour	Black			
Pitch	7.62 mm			
Pol.	L1	(inch)	Qty.	Order No.
2	7.62	0.300	52	1156710000
3	15.24	0.600	40	1156720000
4	22.86	0.900	32	1156740000

Representative deratings curve

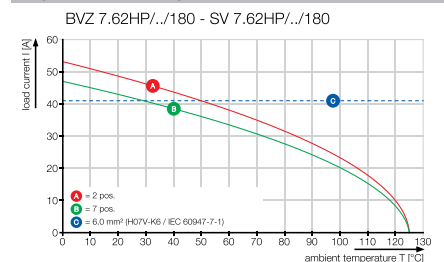

BVZ 7.62IT../180MF3



BVZ 7.62IT../180MF4



Dimensioned drawing

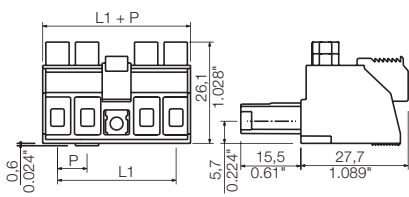

Dimensioned drawing

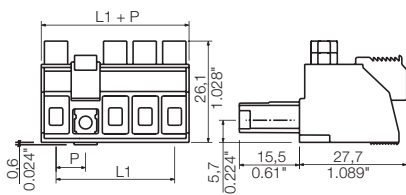

Ordering data

Solder pin length				
Colour				Black
Pitch		7.62 mm		
Pol.	L1	(inch)	Qty.	Order No.
3	15.24	0.600	40	1156730000

Ordering data

Solder pin length				
Colour				Black
Pitch		7.62 mm		
Pol.	L1	(inch)	Qty.	Order No.
4	22.86	0.900	32	1156750000

Additional deratings curves

BVZ 7.62HP../180 - SV 7.62HP../180

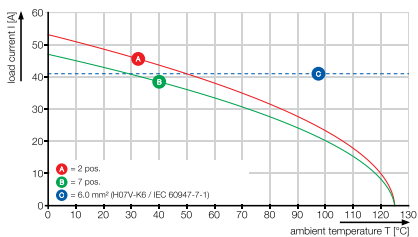

Connectors for IT systems in 10.16 mm pitch
Series BU/SU 10.16 IT – connects up to 16 mm²

SU 10.16IT../90MF

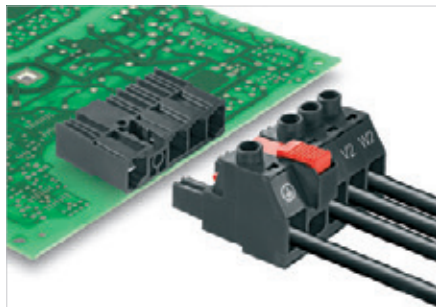

Male header in 90 ° outlet direction with a leading PE contact for IT networks. UL approval according to UL840 for 600 V. Used together with a BUZ 10.16 IT female plug. It complies with the expanded requirements for 5.5 mm of touch protection (400 V relative to earth), according to IEC 61800-5-1. When no female plug is present, the mating profile ensures at least 1 mm of finger protection with a test finger pressure of 20 N.

The middle flange interlock feature decreases the space required by one pole when compared to other solutions.

Available on request with screw flange mounting block or without flange.

Product data

IEC: 1000 V / 76 A
 UL: 300 V / 54 A

For additional articles and information, refer to catalog.weidmueller.com

Note:

- Additional colours on request
- Rated current related to rated cross-section & min. No. of poles.
- P on drawing = pitch
- Rated data refer only to the component itself. Clearance and creepage distances to other components are to be designed in accordance with the relevant application standards.

SU 10.16IT../90MF2



Dimensioned drawing

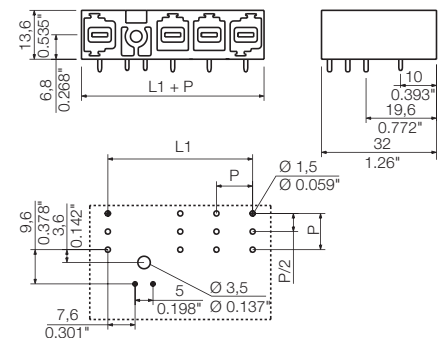

Technical data

In compliance with IEC 60664-1 / IEC 61984

Clamping range, max.	mm ²		
Solid core H05(07) V-U	mm²		
Stranded H07 V-R			
Flexible H05(07) V-K	mm ²		
Flexible with ferrule	mm ²		
Ferrule with plastic collar	mm ²		
Stripping length	mm		
Screwdriver blade	mm		
According to norm			
Tightening torque range	Nm		
Rated current, max.	A	76	72
At ambient temperature		20°C	40°C
For conductor cross-section	mm ²		
Overtoltage category		III	III II
Pollution severity		3	2 2
Rated voltage	V	690	1000 1000
Rated impulse voltage	kV	8	8 6
UL / CUL (Use Group)		B	C D
Rated voltage	V	300	300 600
Rated current	A	54	54 5
AWG conductor	AWG		-
CSA (Use Group)		B	C D
Rated voltage	V	300	300 600
Rated current	A	54	54 5
AWG conductor	AWG		-
General data			
Type of insulation material		PA GF	
UL 94 flammability rating		V-0	
Contact base material		Copper alloy	
Material of contact surface		silver-plated	
Pin dimensions = d	mm	1.2 x 1.1	
Solder eyelet Ø = D	mm	1.6	
Solder eyelet Ø tolerance	mm	+ 0,1	

Accessories

Note: Refer to the Accessories chapter for additional accessories.

Coding	Order No.
KO BV/SV7.62	1824410000



Ordering data

Solder pin length		3.5 mm	
Colour		Black	
Pitch 10.16 mm			
Pol.	L1	(inch)	Qty. Order No.
2	20.32	0.800	60 1156650000
3	30.48	1.200	42 1156670000
4	40.64	1.600	36 1156690000

SU 10.16IT../90MF3



SU 10.16IT../90MF4



Dimensioned drawing

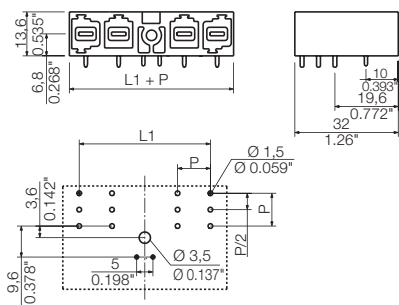

Dimensioned drawing

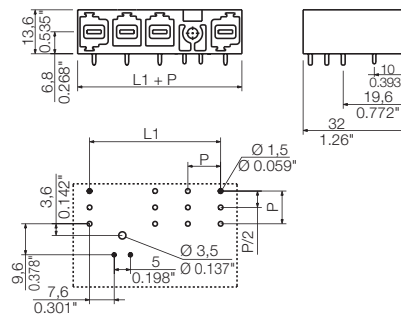

Ordering data

Solder pin length		3.5 mm		
Colour		Black		
Pitch		10.16 mm		
Pol.	L1	(inch)	Qty.	Order No.
3	30.48	1.200	42	1156680000

Ordering data

Solder pin length		3.5 mm		
Colour		Black		
Pitch		10.16 mm		
Pol.	L1	(inch)	Qty.	Order No.
4	40.64	1.600	36	1156700000

Connectors for IT systems in 10.16 mm pitch
Series BU/SU 10.16 IT – connects up to 16 mm²

SU 10.16IT../270MF

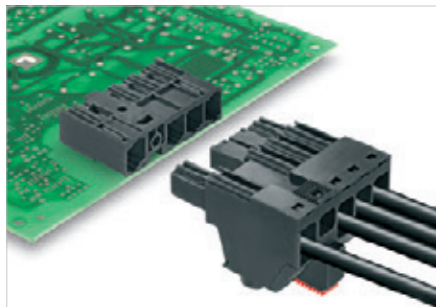

Male header in 270° outlet direction with a leading PE contact for IT networks. UL approval according to UL840 for 600 V. Used together with a BUZ 10.16 IT female plug. It complies with the expanded requirements for 5.5 mm of touch protection (400 V relative to earth), according to IEC 61800-5-1. When no female plug is present, the mating profile ensures at least 1 mm of finger protection with a test finger pressure of 20 N.

The middle flange interlock feature decreases the space required by one pole when compared to other solutions.

Available on request with screw flange mounting block or without flange.

Product data

IEC: 1000 V / 76 A
 UL: 300 V / 54 A

For additional articles and information, refer to catalog.weidmueller.com

Note:

- Additional colours on request
- Rated current related to rated cross-section & min. No. of poles.
- P on drawing = pitch
- Rated data refer only to the component itself. Clearance and creepage distances to other components are to be designed in accordance with the relevant application standards.

SU 10.16IT../270MF2



Dimensioned drawing

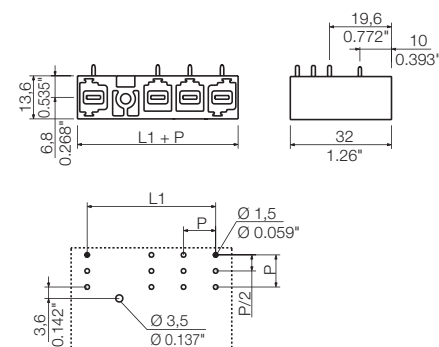

Technical data

In compliance with IEC 60664-1 / IEC 61984			
Clamping range, max.	mm ²		
Solid core H05(07) V-U	mm²		
Stranded H07 V-R			
Flexible H05(07) V-K	mm ²		
Flexible with ferrule	mm ²		
Ferrule with plastic collar	mm ²		
Stripping length	mm		
Screwdriver blade	mm		
According to norm			
Tightening torque range	Nm		
Rated current, max.	A	76	72
At ambient temperature		20°C	40°C
For conductor cross-section	mm ²		
Overvoltage category		III	III II
Pollution severity		3	2 2
Rated voltage	V	690	1000 1000
Rated impulse voltage	kV	8	8 6
UL / CUL (Use Group)		B	C D
Rated voltage	V	300	300 600
Rated current	A	54	54 5
AWG conductor	AWG		-
CSA (Use Group)		B	C D
Rated voltage	V	300	300 600
Rated current	A	54	54 5
AWG conductor	AWG		-
General data			
Type of insulation material		PA GF	
UL 94 flammability rating		V-0	
Contact base material		Copper alloy	
Material of contact surface		silver-plated	
Pin dimensions = d	mm	1.2 x 1.1	
Solder eyelet Ø = D	mm	1.6	
Solder eyelet Ø tolerance	mm	+ 0,1	

Accessories

Note: Refer to the Accessories chapter for additional accessories.

Coding		Order No.
	KO BV/SV.7.62	1824410000

Ordering data

Solder pin length		3.5 mm	
Colour		Black	
Pitch 10.16 mm			
Pol.	L1	(inch)	Qty. Order No.
2	20.32	0.800	60 1157310000
3	30.48	1.200	42 1157320000
4	40.64	1.600	36 1157340000

SU 10.16IT../270MF3



SU 10.16IT../270MF4



Dimensioned drawing

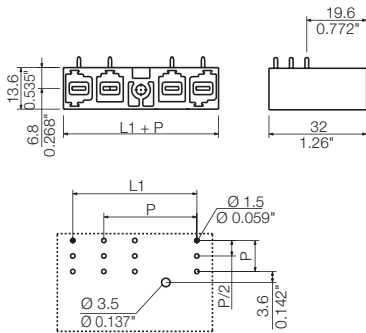

Dimensioned drawing

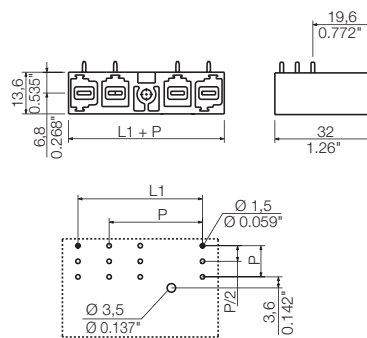

Ordering data

Solder pin length		3.5 mm		
Colour		Black		
Pitch		10.16 mm		
Pol.	L1	(inch)	Qty.	Order No.
3	30.48	1.200	42	1157330000

Ordering data

Solder pin length		3.5 mm		
Colour		Black		
Pitch		10.16 mm		
Pol.	L1	(inch)	Qty.	Order No.
4	40.64	1.600	36	1157350000

BUZ 10.16IT../180MF

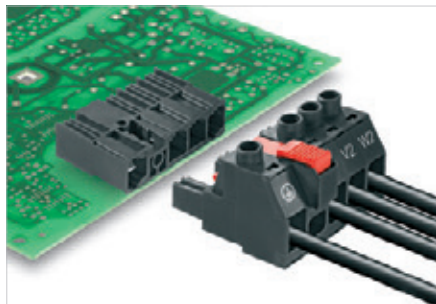

Female plug in 180° outlet direction for IT networks. Fulfils the requirements of UL1059 for 600 V Use Group C with leading PE contact when used with SU 10.16 IT male header. Fulfils the expanded requirements for 5.5 mm of touch protection (400 V relative to earth), according to IEC 61800-5-1.

The middle flange interlocks automatically and is optionally available with screw connection. It decreases the space required by one pole when compared to other solutions.

Available optionally without middle flange interlock.

Product data

IEC: 1000 V / 78 A / 0.2 - 16 mm²
UL: 300 V / 54 A / AWG 22 - 6

For additional articles and information, refer to catalog.weidmueller.com

- Note:**
- Additional colours on request
 - Rated current related to rated cross-section & min. No. of poles.
 - Wire end ferrule without plastic collar to DIN 46228/1
 - Wire end ferrule with plastic collar to DIN 46228/4
 - P on drawing = pitch
 - Rated data refer only to the component itself. Clearance and creepage distances to other components are to be designed in accordance with the relevant application standards.

BUZ 10.16IT../180MF2



Dimensioned drawing

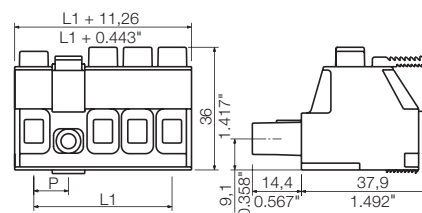

Technical data

In compliance with IEC 60664-1 / IEC 61984			
Clamping range, max.	mm ²	0.2...16	
Solid core H05(07) V-U	mm²	0.2...16	
Stranded H07 V-R	mm ²	6...16	
Flexible H05(07) V-K	mm ²	0.5...16	
Flexible with ferrule	mm ²	0.25...16	
Ferrule with plastic collar	mm ²	0.25...10	
Stripping length	mm	12	
Screwdriver blade	mm	1.0 x 5.5	
According to norm		DIN 5264	
Tightening torque range	Nm	1.2...1.5	
Rated current, max.	A	78	72
At ambient temperature		20°C	40°C
For conductor cross-section	mm ²	16	
Overvoltage category		III	III II
Pollution severity		3	2 2
Rated voltage	V	1000	1000 1000
Rated impulse voltage	kV	8	8 6
UL / CUL (Use Group)	B C D		
Rated voltage	V	300	600 600
Rated current	A	54	54 5
AWG conductor	AWG	22-6	
CSA (Use Group)	B C D		
Rated voltage	V	300	600 600
Rated current	A	54	54 5
AWG conductor	AWG	22-6	
General data			
Type of insulation material		PA GF	
UL 94 flammability rating		V-0	
Contact base material		Copper alloy	
Material of contact surface		silver-plated	
Pin dimensions = d	mm		
Solder eyelet Ø = D	mm		
Solder eyelet Ø tolerance	mm		

Accessories

Note: Refer to the Accessories chapter for additional accessories.

Coding	Order No.
_____	KO BV/SV7.62 1824410000
Screwdriver	
_____	SDIS 1.0X5.5X125 9008410000
Crosshead screwdriver	
_____	SDIK PZZ 900890000
_____	SDK PZZ 9008540000

Ordering data

Solder pin length				
Colour	Black			
Pitch	10.16 mm			
Pol.	L1	(inch)	Qty.	Order No.
2	10.16	0.400	30	1156600000
3	20.32	0.800	21	1156610000
4	30.48	1.200	18	1156630000

Representative deratings curve

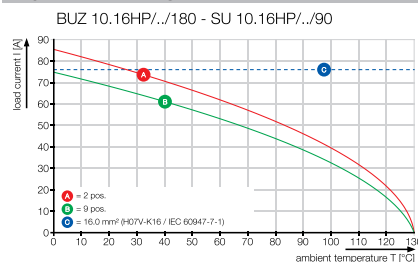

BUZ 10.16IT../180MF3



BUZ 10.16IT../180MF4



Dimensioned drawing

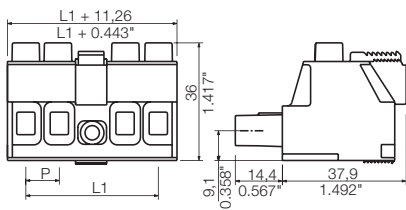

Dimensioned drawing

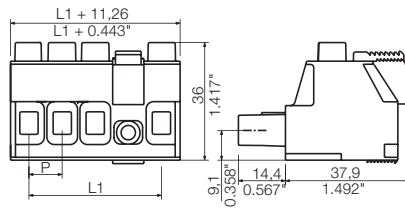

Ordering data

Solder pin length				
Colour	Black			
Pitch	10.16 mm			
Pol.	L1	(inch)	Qty.	Order No.
3	20.32	0.800	21	1156620000

Ordering data

Solder pin length				
Colour	Black			
Pitch	10.16 mm			
Pol.	L1	(inch)	Qty.	Order No.
4	30.48	1.200	18	1156640000

Additional deratings curves

BUZ 10.16HP../180 - SU 10.16HP../180

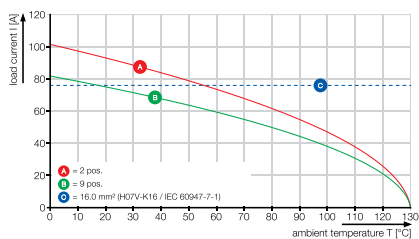



OMNIMATE Power BV / SV 7.62HP Hybrid – for power, signals and EMC

Three functions in one!

The OMNIMATE Power Hybrid connector provides developers and users with the perfect three-in-one solution.

The hybrid motor connector can simultaneously connect power, signals and a pluggable EMC shield. This allows you to save space on the circuit board, on the outside of the housing and in the electrical cabinet. The self-locking one-handed interlock mechanism requires only one plugging step and thus speeds up installation and maintenance procedures. It is easy to handle and interlocks automatically – even in difficult installation positions. The unique shielding shape with 30° cable entry enables a space savings of up to 10 cm between rows.

Unique safety

Safe, EMC-compliant shield connection for any application situation and with no risk of error.



Unique integration

Three-in-one solution: pluggable shield support, integrated signal contacts, and one-handed security flange.

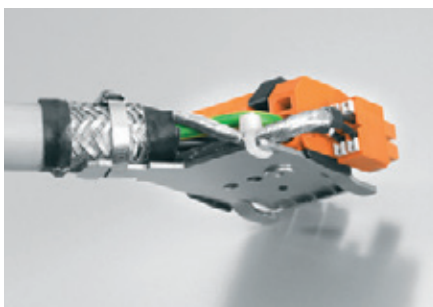

Unique component density

Higher packaging density and more space in the housing wall and on the printed-circuit board due to as much as 38 % space savings in the construction width.

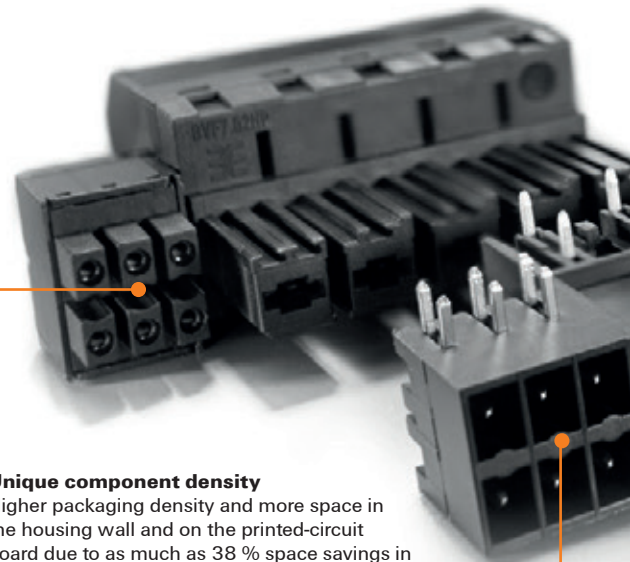

Unique interaction

Plug & Work with intuitive handling: featuring tool-free one-handed operation with automatic snap-in and also “blind” plugging of power, signals and shielding simultaneously.

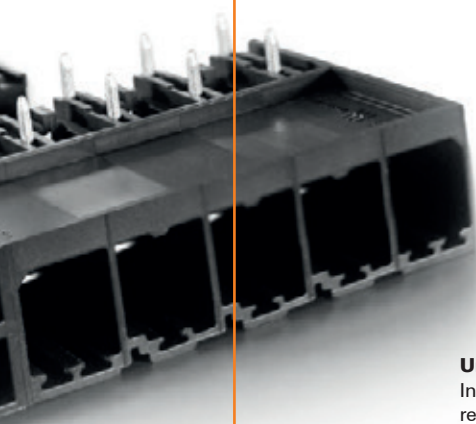
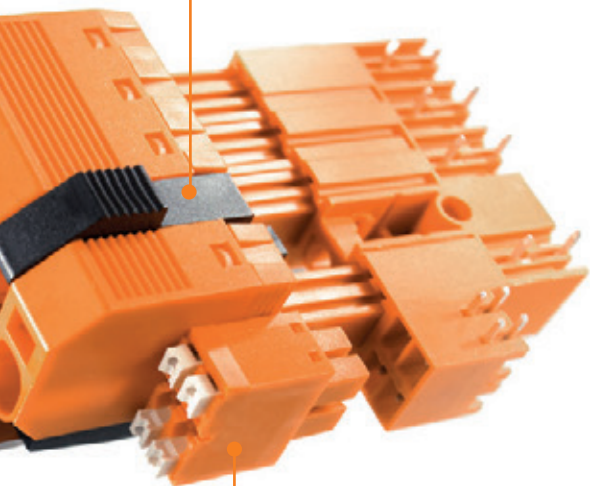

Unique innovation

Integrating functions, optimising processes, and reducing complexity: The conventional 2 outer flanges have simply been replaced by 1 middle flange, 4 signal contacts and 1 pluggable shield support.

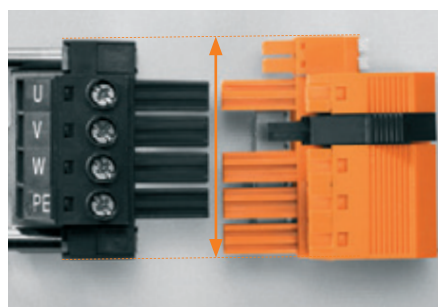

EMC in theory and in the real world

The motor feedback (signal feedback from temperature/encoder) in hybrid, shield-within-shield motor cables is usually made from over-sized power contacts or from disconnected I/O connectors. It also normally requires two separate shield connections. During installation and repairs (replacement), it is possible that the shield terminals could be incorrectly connected, left disconnected or lost. With conventional shielding, it can be quite difficult to tighten the flange screws when the connection is located at a difficult to reach location. So this step is often neglected in the real world.

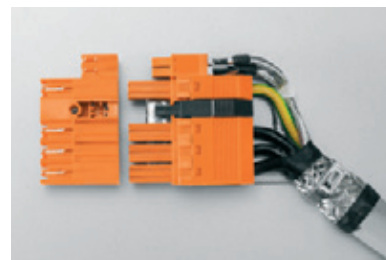

Reliably avoiding interferences

As a result, malfunctions can then be caused by the coupling of electromagnetic fields within the sensitive electronics. The pluggable, hybrid shield support features a special EMC spring-contact strip which ensures that the shield connection to the housing is permanent, vibration-proof and covers a large surface area. It allows the shielding braid from the power and signal wires to be connected separately – and enables this to be done automatically in one step so that it is not dependent on the user.

Topology of parasitic currents

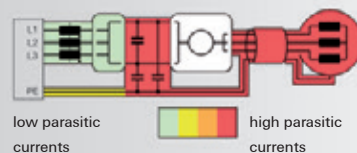

Source: Fraunhofer IZM

<http://www.OMNIMATE.net>

○ = Wire-to-Board
 ● = Board-to-Board
 ● = Wire-to-Wire
 ● = Board-to-Wire

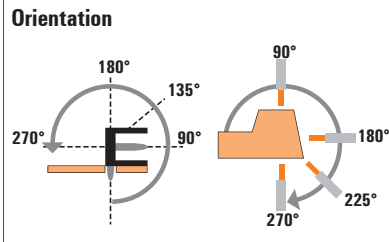

Hybrid pin header



Solder connection



BV/SV 7.62 series



Type	SV & SC 3.81
Orientation	90°/270°
Flange options	G/MF
Product code numbers	IEC: 100 V/38 A/0.5 - 10 mm ² UL: 600 V/35 A/AWG 24 - 10
Page	F.116

Hybrid female connector	Spring PUSH IN		BVF & BC 3.81	180°	(G)/MF	IEC: 1.000 V/41 A/0.2 - 10 mm ² UL: 600 V/35 A/AWG 24 - 10	F.181	○ ●
			BVF & BC 3.81*	180°	(G)/MF	IEC: 1.000 V/41 A/0.2 - 10 mm ² UL: 600 V/35 A/AWG 24 - 10	F.181	○ ●

* shield support as accessories on H.3

Female plug and header:

- (G) = Closed (without flange)
- MF = Centre flange with clasp

Male header and plug:

- G = Closed (without flange)
- MF = Centre flange for clasp

Connectors in 7.62 mm pitch
Series BV/SV 7.62 - connection up to 6 mm²

SV 7.62HP/./90 & SC 3.81

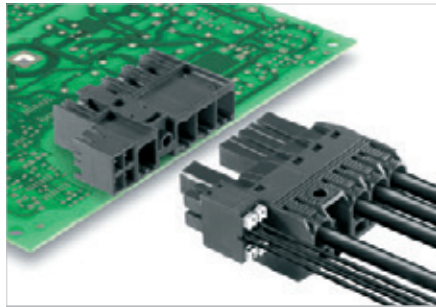

Hybrid-header in 90° outlet direction with power and signal contacts. Meets the enhanced requirements of IEC 61800-5-1 for 3 mm touch safety in 400 V TNC (S) networks and enables UL approval for 600 V in accordance with UL508 / UL840. The middle flange interlocks automatically. It decreases the space required by one pole when compared to other solutions.

- Available with a middle flange (MF).

Product data

IEC: 1000 V / 41 A
 UL: 300 V / 35 A

For additional articles and information, refer to catalog.weidmueller.com

Note:

- Technical specifications refer to the power contacts
- Technical specifications of signal contacts: 50V / 5A
- Rated current related to rated cross-section & min. No. of poles.
- Specifications of diagram: P1=7.62 mm; P2=3.81 mm
- Rated data refer only to the component itself. Clearance and creepage distances to other components are to be designed in accordance with the relevant application standards.

SV 7.62HP/./90 SC/./R



Dimensioned drawing

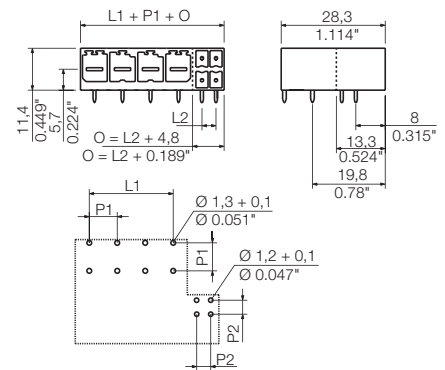

Technical data

In compliance with IEC 60664-1 / IEC 61984			
Clamping range, max.	mm ²		
Solid core H05(07) V-U	mm²		
Stranded H07 V-R			
Flexible H05(07) V-K	mm ²		
Flexible with ferrule	mm ²		
Ferrule with plastic collar	mm ²		
Stripping length	mm		
Screwdriver blade	mm		
According to norm			
Tightening torque range	Nm		
Rated current, max.	A	41	41
At ambient temperature		20°C	40°C
For conductor cross-section	mm ²		
Overvoltage category		III	III II
Pollution severity		3	2 2
Rated voltage	V	630	630 1000
Rated impulse voltage	kV	6	6 6
UL / CUL (Use Group)		B	C D
Rated voltage	V	300	300 600
Rated current	A	35	35 5
AWG conductor	AWG		-
CSA (Use Group)		B	C D
Rated voltage	V	300	300 600
Rated current	A	35	35 5
AWG conductor	AWG		-
General data			
Type of insulation material		PA GF	
UL 94 flammability rating		V-0	
Contact base material		Copper alloy	
Material of contact surface		tinned	
Pin dimensions = d	mm	0.8 x 1.0	
Solder eyelet Ø = D	mm	1.3	
Solder eyelet Ø tolerance	mm	+ 0,1	

Accessories

Note: Refer to the Accessories chapter for additional accessories.

Coding	Order No.
BV/SV 7.62HP K0	1937590000

Ordering data

Solder pin length		3.5 mm	
Colour		Black	
Pitch 7.62 mm			
Pol.	L1 (inch)	L2 (inch)	Qty. Order No.
2 / 4	7.62 0.300	3.81 0.150	78 1089840000
2 / 6	7.62 0.300	7.62 0.300	72 1089920000
2 / 8	7.62 0.300	11.43 0.450	60 1157040000
3 / 4	15.24 0.600	3.81 0.150	60 1090040000
3 / 6	15.24 0.600	7.62 0.300	54 1090120000
3 / 8	15.24 0.600	11.43 0.450	48 1157050000
4 / 4	22.86 0.900	3.81 0.150	48 1090280000
4 / 6	22.86 0.900	7.62 0.300	42 1090360000
4 / 8	22.86 0.900	11.43 0.450	42 1157380000
5 / 4	30.48 1.200	3.81 0.150	36 1090520000
5 / 6	30.48 1.200	7.62 0.300	36 1090590000
5 / 8	30.48 1.200	11.43 0.450	36 1157080000

SV 7.62HP/./90MF. SC/..R



SV 7.62HP/./90MSF. SC/..R



Dimensioned drawing

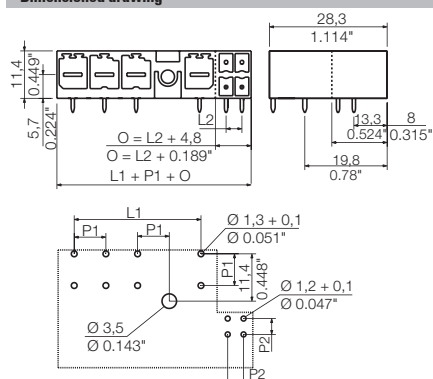

Dimensioned drawing

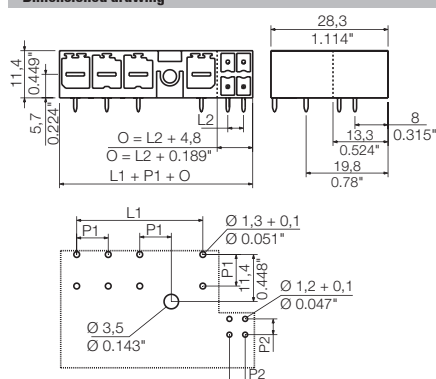

Ordering data

Solder pin length		3.5 mm	
Colour		Black	
Pitch		7.62 mm	
Pol.	L1 (inch)	L2 (inch)	Order No.
2 / 4	15.24	0.600	1089370000
2 / 6	15.24	0.600	1089410000
2 / 8	15.24	0.600	1156820000
3 / 4	22.86	0.900	1156230000
3 / 4	22.86	0.900	1089660000
3 / 6	22.86	0.900	1156240000
3 / 6	22.86	0.900	1089730000
3 / 8	22.86	0.900	1156840000
3 / 8	22.86	0.900	1156850000
4 / 4	30.48	1.200	1090130000
4 / 6	30.48	1.200	1090210000
4 / 8	30.48	1.200	1156890000
5 / 4	38.10	1.500	1156910000
5 / 4	38.10	1.500	1090600000
5 / 6	38.10	1.500	1156930000
5 / 6	38.10	1.500	1090670000
5 / 8	38.10	1.500	1156950000
5 / 8	38.10	1.500	1156980000

Ordering data

Solder pin length		3.5 mm	
Colour		Black	
Pitch		7.62 mm	
Pol.	L1 (inch)	L2 (inch)	Order No.
2 / 4	15.24	0.600	1089510000
2 / 8	15.24	0.600	1156830000
2 / 6	15.24	0.600	1089570000
3 / 4	22.86	0.900	1156250000
3 / 4	22.86	0.900	1089990000
3 / 6	22.86	0.900	1156270000
3 / 6	22.86	0.900	1089970000
3 / 8	22.86	0.900	1156870000
3 / 8	22.86	0.900	1156880000
4 / 4	30.48	1.200	1090370000
4 / 6	30.48	1.200	1090450000
4 / 8	30.48	1.200	1156900000
5 / 4	38.10	1.500	1157000000
5 / 4	38.10	1.500	1090830000
5 / 6	38.10	1.500	1157010000
5 / 6	38.10	1.500	1090900000
5 / 8	38.10	1.500	1157020000
5 / 8	38.10	1.500	1157030000

Connectors in 7.62 mm pitch
Series BV/SV 7.62 - connection up to 6 mm²

SV 7.62HP/./270 & SC 3.81

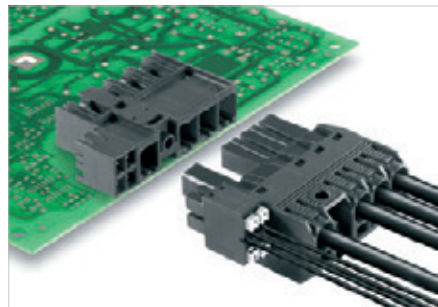

Hybrid male header in 270° outlet direction with power and signal contacts. Meets the enhanced requirements of IEC 61800-5-1 for 3 mm touch safety in 400 V TNC (S) networks and enables UL approval for 600 V in line with UL508 / UL840. The middle flange interlocks automatically. It decreases the space required by one pole when compared to other solutions.

- Available with a middle flange (MF).

Product data

IEC: 1000 V / 41 A
 UL: 300 V / 35 A

For additional articles and information, refer to catalog.weidmueller.com

Note:

- Technical specifications refer to the power contacts
- Technical specifications of signal contacts: 50V / 5A
- Rated current related to rated cross-section & min. No. of poles.
- Specifications of diagram: P1=7.62 mm; P2=3.81 mm
- Rated data refer only to the component itself. Clearance and creepage distances to other components are to be designed in accordance with the relevant application standards.

SV 7.62HP/./270 SC/..R



Dimensioned drawing

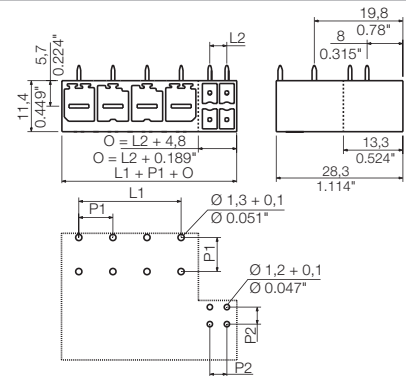

Ordering data

Solder pin length		3.5 mm				
Colour		Black				
Pitch 7.62 mm						
Pol.	L1 (inch)	L2 (inch)	Qty.	Order No.		
2 / 4	7.62	0.300	3.81	0.150	78	1090770000
2 / 6	7.62	0.300	7.62	0.300	72	1090850000
2 / 8	7.62	0.300	11.43	0.450	60	1156920000
3 / 4	15.24	0.600	3.81	0.150	60	1090950000
3 / 6	15.24	0.600	7.62	0.300	54	1091010000
3 / 8	15.24	0.600	11.43	0.450	48	1156940000
4 / 4	22.86	0.900	3.81	0.150	48	1091120000
4 / 6	22.86	0.900	7.62	0.300	42	1091160000
4 / 8	22.86	0.900	11.43	0.450	42	1156970000
5 / 4	30.48	1.200	3.81	0.150	36	1091240000
5 / 6	30.48	1.200	7.62	0.300	36	1091260000
5 / 8	30.48	1.200	11.43	0.450	36	1156990000

Technical data

In compliance with IEC 60664-1 / IEC 61984			
Clamping range, max.	mm ²		
Solid core H05(07) V-U	mm²		
Stranded H07 V-R			
Flexible H05(07) V-K	mm ²		
Flexible with ferrule	mm ²		
Ferrule with plastic collar	mm ²		
Stripping length	mm		
Screwdriver blade	mm		
According to norm			
Tightening torque range	Nm		
Rated current, max.	A	41	41
At ambient temperature		20°C	40°C
For conductor cross-section	mm ²		
Overvoltage category		III	III II
Pollution severity		3	2 2
Rated voltage	V	630	630 1000
Rated impulse voltage	kV	6	6 6
UL / CUL (Use Group)		B	C D
Rated voltage	V	300	300 600
Rated current	A	35	35 5
AWG conductor	AWG		-
CSA (Use Group)		B	C D
Rated voltage	V	300	300 600
Rated current	A	35	35 5
AWG conductor	AWG		-
General data			
Type of insulation material		PA GF	
UL 94 flammability rating		V-0	
Contact base material		Copper alloy	
Material of contact surface		tinned	
Pin dimensions = d	mm	0.8 x 1.0	
Solder eyelet Ø = D	mm	1.3	
Solder eyelet Ø tolerance	mm	+ 0,1	

Accessories

Note: Refer to the Accessories chapter for additional accessories.

Coding		Order No.
	BV/SV 7.62HP K0	1937590000

SV 7.62HP../270MF.SC../R



SV 7.62HP../270MSF.SC../R



Dimensioned drawing

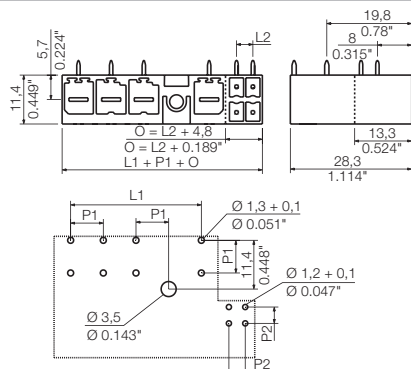

Dimensioned drawing

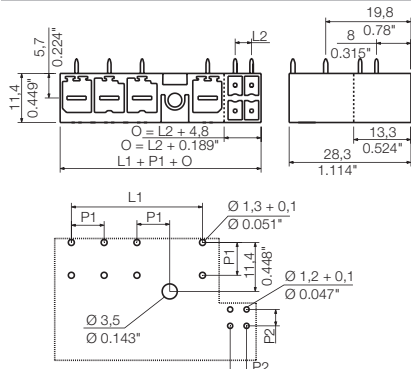

Ordering data

Solder pin length		3.5 mm	
Colour		Black	
Pitch		7.62 mm	
Pol.	L1 (inch)	L2 (inch)	Order No.
2 / 4	15.24	0.600	1089260000
2 / 6	15.24	0.600	1089280000
2 / 8	15.24	0.600	1156120000
3 / 4	22.86	0.900	1156140000
3 / 4	22.86	0.900	1089440000
3 / 6	22.86	0.900	1156150000
3 / 6	22.86	0.900	1089490000
3 / 8	22.86	0.900	1156170000
3 / 8	22.86	0.900	1156180000
4 / 4	30.48	1.200	1089820000
4 / 6	30.48	1.200	1089910000
4 / 8	30.48	1.200	1156280000
5 / 4	38.10	1.500	1156300000
5 / 4	38.10	1.500	1090300000
5 / 6	38.10	1.500	1156310000
5 / 6	38.10	1.500	1090380000
5 / 8	38.10	1.500	1156320000
5 / 8	38.10	1.500	1156340000

Ordering data

Solder pin length		3.5 mm	
Colour		Black	
Pitch		7.62 mm	
Pol.	L1 (inch)	L2 (inch)	Order No.
2 / 4	15.24	0.600	1089340000
2 / 6	15.24	0.600	1089380000
2 / 8	15.24	0.600	1156130000
3 / 4	22.86	0.900	1156190000
3 / 4	22.86	0.900	1089610000
3 / 6	22.86	0.900	1156200000
3 / 6	22.86	0.900	1089670000
3 / 8	22.86	0.900	1156210000
3 / 8	22.86	0.900	1156220000
4 / 4	30.48	1.200	1090060000
4 / 6	30.48	1.200	1090140000
4 / 8	30.48	1.200	1156290000
5 / 4	38.10	1.500	1156370000
5 / 4	38.10	1.500	1090540000
5 / 6	38.10	1.500	1156390000
5 / 6	38.10	1.500	1090610000
5 / 8	38.10	1.500	1156410000
5 / 8	38.10	1.500	1156430000

Connectors in 7.62 mm pitch
Series BV/SV 7.62 - connection up to 6 mm²

BVF 7.62HP../180 & BCF 3.81

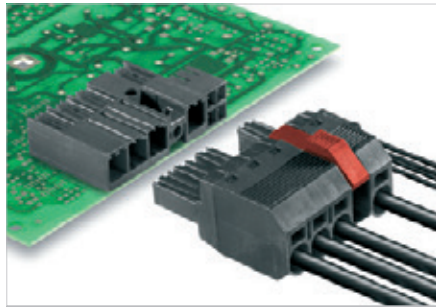

Hybrid female plug with power and signal contacts with PUSH IN connection system. Allows power, signals and shield to be plugged in simultaneously. It is perfect for connecting servo-drives and asynchronous drives. Meets the requirements of UL1059 for 600 V Use Group C. The mating profile ensures touch-safety of > 3 mm in accordance with IEC 61800-5-1. The pluggable shield connection establishes a large contact area on the device housing and does not need to be screwed on separately.

Product data

IEC: 1000 V / 38 A / 0.5 - 10 mm²
 UL: 600 V / 35 A / AWG 24 - 8

For additional articles and information, refer to catalog.weidmueller.com

Note:

- Technical specifications refer to the power contacts
- Technical specifications of signal contacts: 50V / 5A
- Additional colours on request
- Rated current related to rated cross-section & min. No. of poles.
- Wire end ferrule without plastic collar to DIN 46228/1
- Wire end ferrule with plastic collar to DIN 46228/4
- Rated data refer only to the component itself. Clearance and creepage distances to other components are to be designed in accordance with the relevant application standards.

BVF 7.62HP../180 BCF../R



Dimensioned drawing

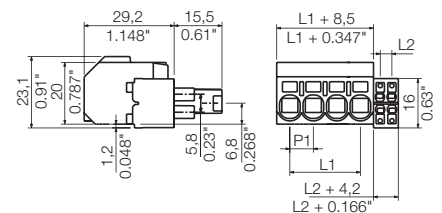

Technical data

In compliance with IEC 60664-1 / IEC 61984		
Clamping range, max.	mm ²	0.5...10
Solid core H05(07) V-U	mm²	0.5...10
Stranded H07 V-R		
Flexible H05(07) V-K	mm ²	0.5...10
Flexible with ferrule	mm ²	1.5...6
Ferrule with plastic collar	mm ²	1.5...6
Stripping length	mm	12
Screwdriver blade	mm	0.8 x 4.5
According to norm		DIN 5264
Tightening torque range	Nm	
Rated current, max.	A	38 34
At ambient temperature		20°C 40°C
For conductor cross-section	mm ²	6
Overvoltage category		III III II
Pollution severity		3 2 2
Rated voltage	V	800 1000 1000
Rated impulse voltage	kV	8 8 6
UL / CUL (Use Group)		B C D
Rated voltage	V	600 600 600
Rated current	A	35 35 5
AWG conductor	AWG	24-8
CSA (Use Group)		B C D
Rated voltage	V	600 600 600
Rated current	A	35 35 5
AWG conductor	AWG	24-8
General data		
Type of insulation material		PA GF
UL 94 flammability rating		V-0
Contact base material		Copper alloy
Material of contact surface		tinned
Pin dimensions = d	mm	
Solder eyelet Ø = D	mm	
Solder eyelet Ø tolerance	mm	

Accessories

Note: Refer to the Accessories chapter for additional accessories.

Coding		Order No.
	BV/SV 7.62HP K0	1937590000
Shielding		
	BVF 7.62HP SH150 4-6 KIT	1118480000
	BVF 7.62HP SH180 4-6 KIT	1118470000
	BVF 7.62HP SH210 4-6 KIT	1118490000
Screwdriver		
	SDS 0.8x4.0x125	9009020000
Crimping tool		
	PZ 6/5	9011460000

Ordering data

Solder pin length						
Colour						Black
Pitch 7.62 mm						
Pol.	L1	(inch)	L2	(inch)	Qty.	Order No.
2 / 4	7.62	0.300	3.81	0.150	65	1080550000
2 / 6	7.62	0.300	7.62	0.300	55	1080320000
2 / 8	7.62	0.300	11.43	0.450	50	1156440000
3 / 4	15.24	0.600	3.81	0.150	50	1080490000
3 / 6	15.24	0.600	7.62	0.300	45	1080570000
3 / 8	15.24	0.600	11.43	0.450	40	1156450000
4 / 4	22.86	0.900	3.81	0.150	40	1080510000
4 / 6	22.86	0.900	7.62	0.300	35	1080440000
4 / 8	22.86	0.900	11.43	0.450	30	1156470000
5 / 8	30.48	1.200	11.43	0.450	25	1156480000

Representative deratings curve

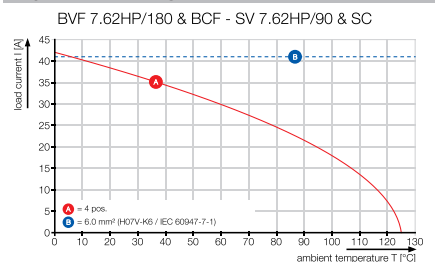

Connectors in 7.62 mm pitch
Series BV/SV 7.62 - connection up to 6 mm²

BVF 7.62HP../180MSF & BCF 3.81

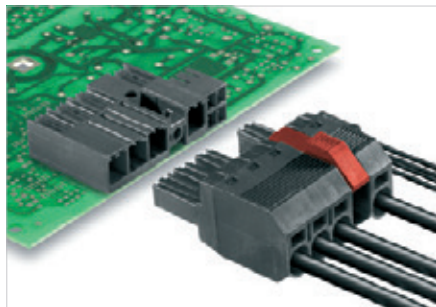

Hybrid female plug with power and signal contacts with PUSH IN connection system. Allows power, signals and shield to be plugged in simultaneously. It is perfect for connecting servo-drives and asynchronous drives. Meets the requirements of UL1059 for 600 V Use Group C. The mating profile ensures touch-safety of > 3 mm in accordance with IEC 61800-5-1. The self-fastening middle flange reduces the space requirements by one pole.

The pluggable shield connection establishes a large contact area on the device housing and does not need to be screwed on separately.

Product data

IEC: 1000 V / 38 A / 0.5 - 10 mm²
 UL: 600 V / 35 A / AWG 24 - 8

For additional articles and information, refer to catalog.weidmueller.com

Note:

- Technical specifications refer to the power contacts
- Technical specifications of signal contacts: 50V / 5A
- Additional colours on request
- Rated current related to rated cross-section & min. No. of poles.
- Wire end ferrule without plastic collar to DIN 46228/1
- Wire end ferrule with plastic collar to DIN 46228/4
- Rated data refer only to the component itself. Clearance and creepage distances to other components are to be designed in accordance with the relevant application standards.

BVF 7.62HP../180MSF, BCF../R



Dimensioned drawing

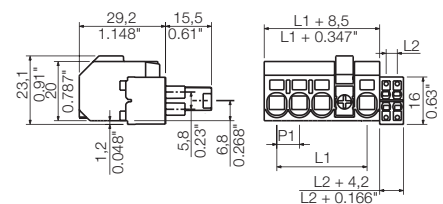

Technical data

In compliance with IEC 60664-1 / IEC 61984			
Clamping range, max.	mm ²	0.5...10	
Solid core H05(07) V-U	mm²	0.5...10	
Stranded H07 V-R			
Flexible H05(07) V-K	mm ²	0.5...10	
Flexible with ferrule	mm ²	1.5...6	
Ferrule with plastic collar	mm ²	1.5...6	
Stripping length	mm	12	
Screwdriver blade	mm	0.8 x 4.5	
According to norm		DIN 5264	
Tightening torque range	Nm		
Rated current, max.	A	38	34
At ambient temperature		20°C	40°C
For conductor cross-section	mm ²	6	
Overvoltage category		III	III II
Pollution severity		3	2 2
Rated voltage	V	800	1000 1000
Rated impulse voltage	kV	8	8 6
UL / CUL (Use Group)		B	C D
Rated voltage	V	600	600 600
Rated current	A	35	35 5
AWG conductor	AWG		24-8
CSA (Use Group)		B	C D
Rated voltage	V	600	600 600
Rated current	A	35	35 5
AWG conductor	AWG	24-8	
General data			
Type of insulation material		PA GF	
UL 94 flammability rating		V-0	
Contact base material		Copper alloy	
Material of contact surface		tinned	
Pin dimensions = d	mm		
Solder eyelet Ø = D	mm		
Solder eyelet Ø tolerance	mm		

Accessories

Note: Refer to the Accessories chapter for additional accessories.

Coding		Order No.
	BV/SV 7.62HP K0	1937590000
Shielding		
	BVF 7.62HP SH150 4-6 KIT	1118480000
	BVF 7.62HP SH180 4-6 KIT	1118470000
	BVF 7.62HP SH210 4-6 KIT	1118490000
Screwdriver		
	SDS 0.8x4.0x125	9009020000
Crimping tool		
	PZ 6/5	9011460000

Ordering data

Solder pin length						
Colour						Black
Pitch 7.62 mm						
Pol.	L1	(inch)	L2	(inch)	Qty.	Order No.
2 / 4	15.24	0.600	3.81	0.150	50	1081930000
2 / 6	15.24	0.600	7.62	0.300	45	1082080000
2 / 8	15.24	0.600	11.43	0.450	40	1157100000
3 / 4	22.86	0.900	3.81	0.150	40	1157440000
3 / 4	22.86	0.900	3.81	0.150	40	1082110000
3 / 6	22.86	0.900	7.62	0.300	35	1157450000
3 / 6	22.86	0.900	7.62	0.300	35	1081730000
3 / 8	22.86	0.900	11.43	0.450	30	1157470000
3 / 8	22.86	0.900	11.43	0.450	30	1157190000
4 / 4	30.48	1.200	3.81	0.150	30	1081660000
4 / 6	30.48	1.200	7.62	0.300	30	1081750000
4 / 8	30.48	1.200	11.43	0.450	25	1157210000
5 / 4	38.10	1.500	3.81	0.150	25	1157270000
5 / 6	38.10	1.500	7.62	0.300	25	1157280000
5 / 8	38.10	1.500	11.43	0.450	25	1157300000
5 / 8	38.10	1.500	11.43	0.450	25	1157290000

Representative deratings curve

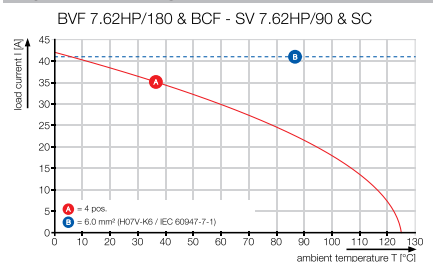

OMNIMATE Power Through-Panel Terminals

OMNIMATE Power Through-Panel Terminals

Through-Panel Terminals for devices series WGK -
connects up to 95 mm²

Explanation	G.2
System overview	G.4
Technical data	G.8

Through-Panel Terminals WGK - OMNIMATE Power

The universal solution to feed power through housing walls. Excellent for applications such as EMC filters, power supplies, frequency converters for drive systems and more encapsulated devices.

Choose from the flexible range:

- Wide performance spectrum for currents up to 232 A and wire cross sections from 4 to 95 mm² (AWG 4/0)
- Various types of connections: castable solder connection, cable-lug-stud connection, and maintenance-free clamping-yoke screw connection
- Shapes for accommodating horizontal or vertical wire outlets

G

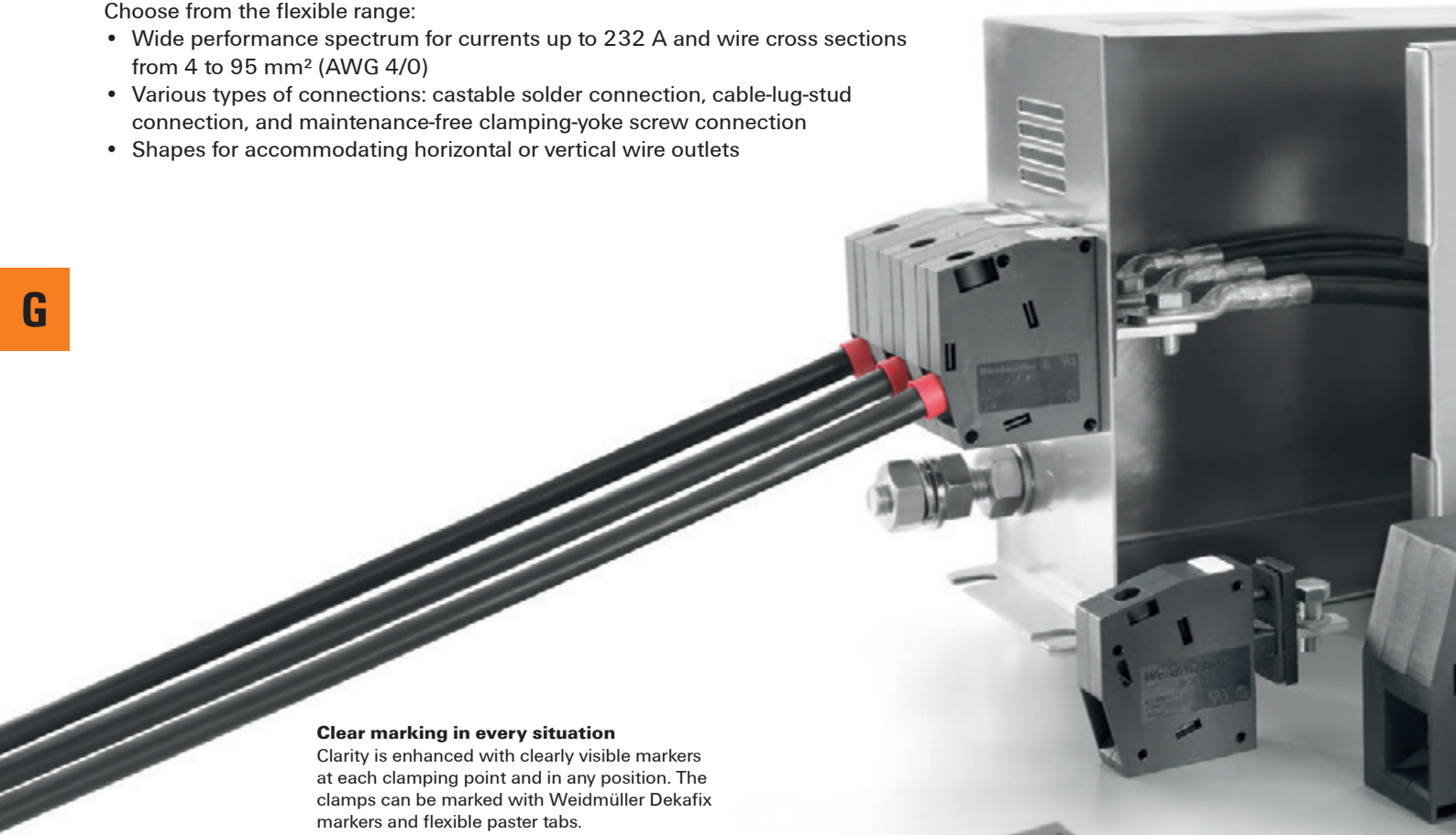

Clear marking in every situation

Clarity is enhanced with clearly visible markers at each clamping point and in any position. The clamps can be marked with Weidmüller Dekafix markers and flexible paster tabs.

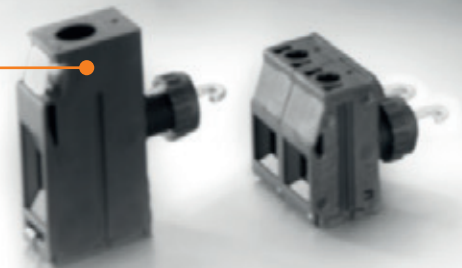

Safety with extra power

The high-performance insulating material WEMID meets maximum system availability requirements: With an RTI (relative temperature index) of 120 °C, the OMNIMATE power Through-Panel Terminals exceed the highest continued use temperature of standard PA (100 °C) at +20° K, thus creating more power reserves and maximum safety with temperature fluctuations and overloads



Easy handling

WGK series lead-through terminals consist of an inside and outside component that are easily locked with one another through the housing wall without any tools.

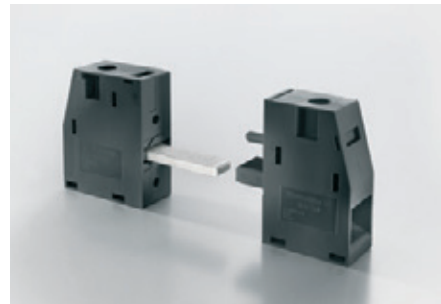

Solid and proven connection

Connections proven a million times. The terminal unit consists of hardened steel, for very high contact force. The current bar is made of copper, which gives a low voltage drop. The tin-plated surface ensures minimum contact resistances.

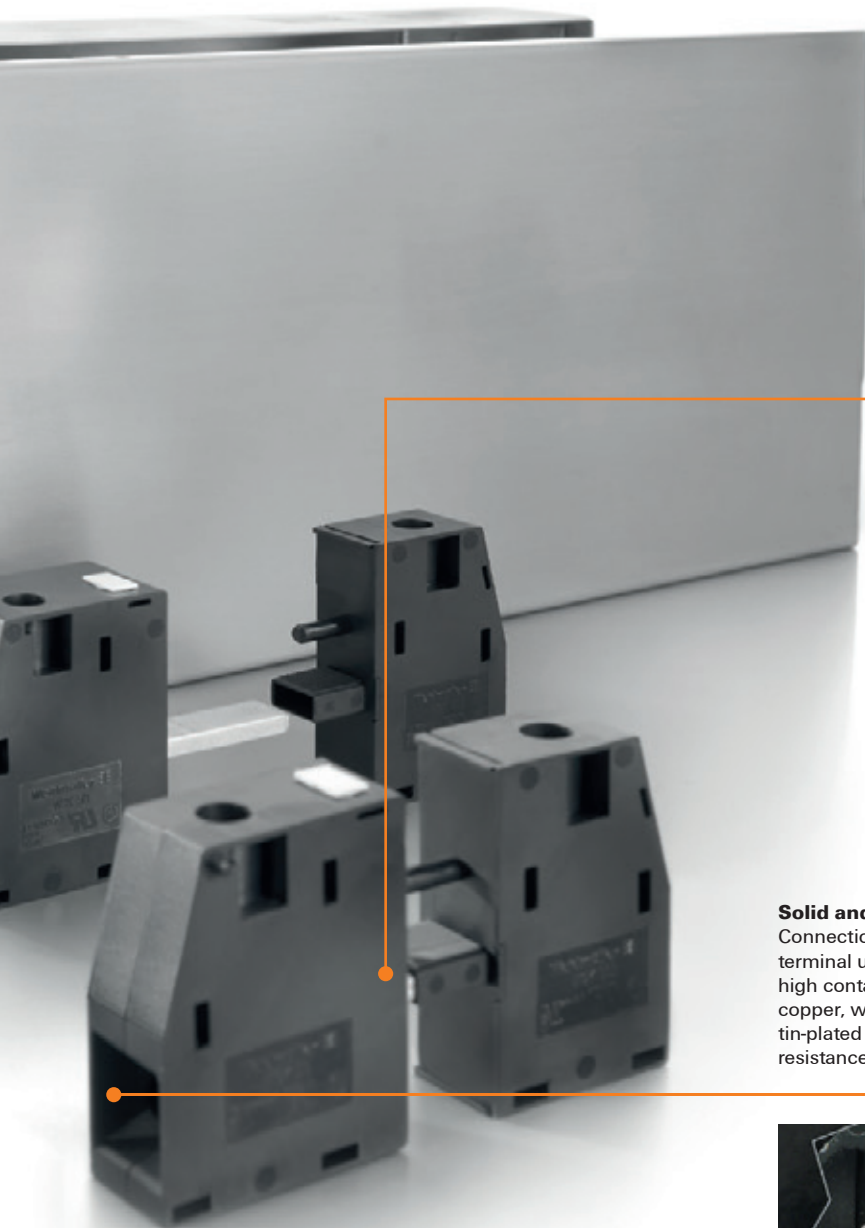
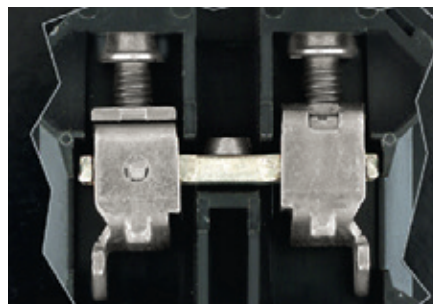

WGK-series system overview

WGK



Easy installation

WGK series feedthrough terminals consist of an inside and outside component that are easily locked with one another through the housing wall without any tools.

VWGK



WGK...VP



WGK...WGKV



Maximum freedom of design

Different types of connection on the inside such as a castable soldering connection (VWGK...), cable lug bolt connection (WGK ...VP) and a no-service clamping yoke-screw connection (WGK...) provide the optimum connection in any installation situation.

Weidmüller offers two models with a horizontal (WGK) and vertical (WGKV) outgoing direction to adapt the conductor guide to the given installation conditions.

The VP and VWGK models of the WGK lead-through terminals with an insulating housing and clamping yoke connection on the outside are enhanced for use in encapsulated and cast equipment (such as EMV filters).

These products are developed for 100 % sealing in completely cast units.

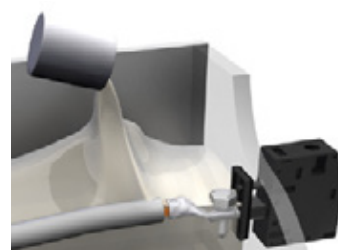

All Through-Panel Terminals terminals are available with pins (WGK.../Z) for easy locking. Multi-pole blocks can be built up quickly and easily.

Clearance and creepage distances to other components must be devised in accordance with the relevant application standard. This can be achieved in the device by full encapsulation or by the use of additional spacer plates.

Distance plates (DP WGK...) can be easily mounted with locking pins.

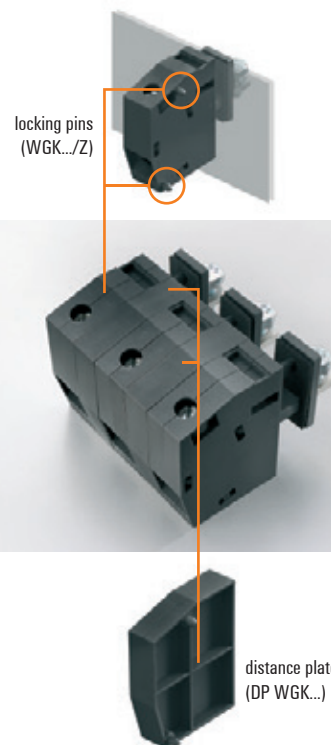

Fast and easy design in online CAD models. The CAD models for OMNIMATE Power WGK lead-through terminals can be found in Weidmüller's online catalogue and in the PART community.

<http://catalog.weidmueller.com/>

<http://weidmueller.partcommunity.com/>

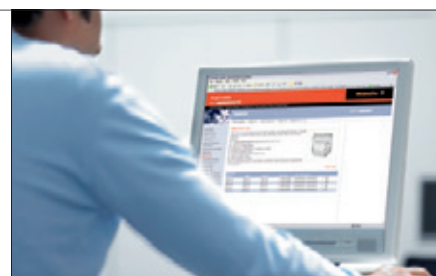

<http://www.OMNIMATE.net>

- = 300 V (UL) / 250 V (IEC)
- = 600 V (UL) / 690 V (IEC)
- = 600 V (UL) / 1.000 V (IEC)
- * = 600 V acc. to UL 508 / UL 840

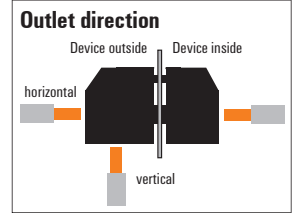

Through-Panel terminals - WGK

Device Outside	Device Inside	Clamping range IEC	Max. rated voltage IEC		
Type of connection	Type of connection	Clamping range UL	Nominal current UL	Tipo	Outlet direction
 Screw Clamping yoke	 Solder connection	0,5 - 6 mm ² 30 - 10 AWG	32 A 30 A		VWGK 4 horizontal
		0,5 - 10 mm ² 22 - 10 AWG	41 A 50 A		VWGK 6 horizontal
 Screw Clamping yoke	 Screw Clamping yoke	0,5 - 6 mm ² 30 - 10 AWG	32 A 30 A		WGK 4 WGKV 4 horizontal vertical
		0,5 - 16 mm ² 24 - 6 AWG	57 A 65 A		WGK 10 WGKV 10 horizontal vertical
 Screw Clamping yoke	 Cable lug	0,5 - 25 mm ² 20 - 4 AWG	76 A 85 A		WGK 16 WGKV 16 horizontal vertical
					WGK 16 VP horizontal
 Screw Clamping yoke	 Cable lug	6 - 34 mm ² 10 - 3 AWG	101 A 100 A		WGK 25 WGKV 25 horizontal vertical
					WGK 25 VP horizontal
 Screw Clamping yoke	 Cable lug	16 - 50 mm ² 6 - 1/0 AWG	150 A 145 A		WGK 50 horizontal
					WGK 50 VP horizontal
 Screw Clamping yoke	 Cable lug	35 - 95 mm ² 4 - 4/0 AWG	232 A 230 A		WGK 95 horizontal
					WGK 95 F VP horizontal

G

Max. rated voltage IEC	400 V	690 V	1.000 V
	Nominal voltage UL	600 V	
	○	*	
	○	*	
	○	*	
	○	*	
		●	
		●	
		●	
		●	
		●	
		●	
			●
			●

Through-Panel Terminals for devices
Series WGK – connects up to 95 mm²

WGK 4

4 mm²

Screw connection



WGKV 4

4 mm²

Screw connection

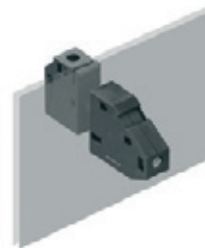

Width/Length/External height	mm
Max. current / Max. wire	A/mm ²
Max. clamping range	mm ²

8.1 x 35.5 x 21.5
41 / 6
0.05...6

8.1 x 40 x 24
41 / 6
0.05...6

Technical data

Rated data	
Rated voltage	V
Rated current	A
For conductor cross-section	mm ²
Rated impulse withstand voltage / Pollution severity	-/-
Gauge to IEC 60947-1 / UL 94 flammability rating	
Approvals	
Clamped conductors (H05V/H07V)	
Solid / Stranded	mm ²
Flexible / Stranded wire with end ferrules	mm ²
Tightening torque (terminal screw)	Nm
Stripping length / Blade size	mm/-

IEC 60947-7-1

IEC	UL / CUL	CSA
250	300	300
32	30	30
4	AWG 30...10	AWG 30...10
6 kV / 3		
A3 / V-0		
CE; CSA; CURUS; GOSTME25; ROHS		

IEC 60947-7-1

IEC	UL / CUL	CSA
250	300	300
32	30	30
4	AWG 30...10	AWG 30...10
6 kV / 3		
A3 / V-0		
CE; CSA; CURUS; GOSTME25; ROHS		

Rated connection	
0.5...6	
0.5...4 / 0.5...4	
0.6...0.8 (M 3)	
8 / 0.6 x 3.5 mm	

Rated connection	
0.5...6	
0.5...4 / 0.5...4	
0.6...0.8 (M 3)	
8 / 0.6 x 3.5 mm	

Note

Metal walls: 1 - 2.5 mm = 400 V; 2.5 - 4 mm = 250 V; plastic walls: 1 - 4 mm = 500 V

Metal walls: 1 - 2.5 mm = 400 V; 2.5 - 4 mm = 250 V; plastic walls: 1 - 4 mm = 500 V

Ordering data

Version	
With locking pins	grey
With locking pins	green/yellow
With locking pins	black
Without locking pins	grey
Without locking pins	green/yellow
Without locking pins	black

Type	Qty.	Order No.
WGK 4/Z	50 ST	1936570000
WGK 4/Z gn/ye	50 ST	1936560000
WGK 4/Z SW	50 ST	1250940000
WGK 4	50 ST	1936550000
WGK 4 GN/YE	50 ST	1936540000
WGK 4 SW	50 ST	1250930000

Type	Qty.	Order No.
WGKV 4/Z	50 ST	1936630000
WGKV 4/Z gn/ye	50 ST	1936620000
WGKV 4/Z SW	50 ST	1250960000
WGKV 4	50 ST	1934050000
WGKV 4 gn/ye	50 ST	1936610000
WGKV 4 SW	50 ST	1250950000

Note

Accessories

Distance plate



Type	Qty.	Order No.
DP WGK 4	50	1936450000
DP WGK 4 SW	50	1297840000

Type	Qty.	Order No.
DP WGKV 4	50	1936470000

Screwdriver



Standard

Type	Qty.	Order No.
SDIS 0.6X3.5X100	1	9008390000

Type	Qty.	Order No.
SDIS 0.6X3.5X100	1	9008390000

Identification systems

(see assortment in catalogue 7)

Marking tags

DEK 5/5 / DEK 5/6 / DEK 5/8

DEK 5/5 / DEK 5/6 / DEK 5/8

For detailed information on other accessories and applications, refer to the „Accessories“ section

Technical drawing

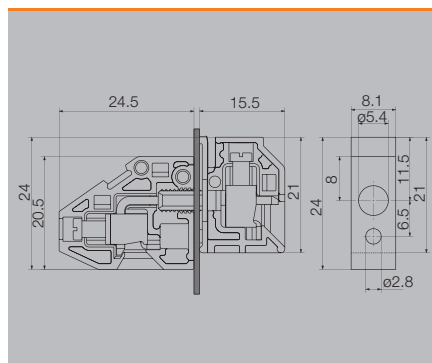
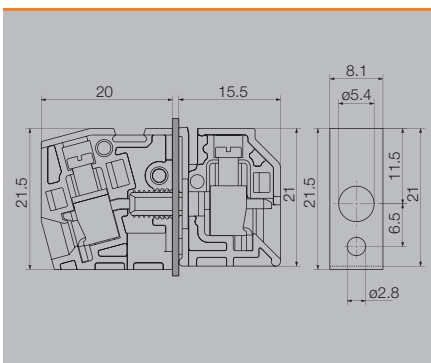

WGK 4 VP

4 mm²

Solder connection



8.1 x 20 x 20.5
41 / 6
0.22...6

IEC 60947-7-1

IEC	UL / CUL	CSA
250	300	300
32	30	30
4	AWG 30...10	AWG 30...10
6 kV / 3 A3 / V-0		
CE; CSA; CURUS; GOSTME25; ROHS		

Rated connection

0.5...6 / 0.5...4
0.5...4 / 0.5...4
0.6...0.8 (M 3)
8 / 0.6 x 3.5 mm

Metal walls: 1 - 4 mm = 500 V Plastic walls: 1 - 4 mm = 500 V

Type	Qty.	Order No.
WGK 4 VP/Z	50	1003910000
WGK 4 VP/Z GN/YE	50	1003900000
WGK 4 VP/Z BK	50	1339810000
WGK 4 VP	50	1981890000
WGK 4 VP GN/YE	50	1003890000
WGK 4 VP BK	50	1339790000

Type	Qty.	Order No.
DP WGK 4	50	1936450000
SDIS 0.6X3.5X100	1	9008390000

DEK 5/5 / DEK 5/6 / DEK 5/8

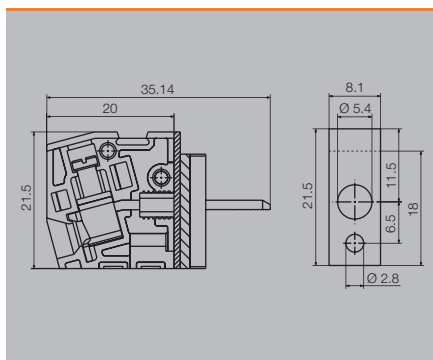

WGK 10

10 mm²

Screw connection



10.1 x 43.3 x 31.4
76 / 16
0.21...16

IEC 60947-7-1

IEC	UL / CUL	CSA
250	300	300
57	65	65
10	AWG 24...6	AWG 24...6
6 kV / 3 B6 / V-0		
CE; CSA; CURUS; GOSTME25; ROHS		

Rated connection

0.5...16 / 0.5...16
0.5...10 / 0.5...10
1.2...1.8 (M 4)
11 / 0.8 x 4.0 mm

Metal walls: 1 - 2.5 mm = 400 V; 2.5 - 4 mm = 250 V; plastic walls: 1 - 4 mm = 500 V

Type	Qty.	Order No.
WGK 10/Z	50 ST	1936530000
WGK 10/Z gn/ye	50 ST	1936520000
WGK 10/Z SW	50 ST	1250890000
WGK 10	50 ST	1936510000
WGK 10 GN/YE	50 ST	1936500000
WGK 10 SW	50 ST	1250880000

Type	Qty.	Order No.
DP WGK 10 SW	50	1250570000
DP WGK 10	50	1936440000
SDIS 0.8X4.0X100	1	9008400000

DEK 5/5 / DEK 5/6 / DEK 5/8

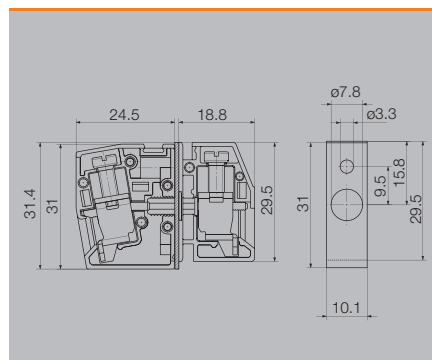

WGKV 10

10 mm²

Screw connection



10.1 x 49.8 x 32.8
76 / 16
0.21...16

IEC 60947-7-1

IEC	UL / CUL	CSA
250	300	300
57	65	65
10	AWG 24...6	AWG 24...6
6 kV / 3 B6 / V-0		
CE; CSA; CURUS; GOSTME25; ROHS		

Rated connection

0.5...16 / 0.5...16
0.5...10 / 0.5...10
1.2...1.8 (M 4)
11 / 0.8 x 4.0 mm

Metal walls: 1 - 2.5 mm = 400 V; 2.5 - 4 mm = 250 V; plastic walls: 1 - 4 mm = 500 V

Type	Qty.	Order No.
WGKV 10/Z	50 ST	1936600000
WGKV 10/Z gn/ye	50 ST	1936590000
WGKV 10/Z SW	50 ST	1250920000
WGKV 10	50 ST	1934060000
WGKV 10 gn/ye	50 ST	1936580000
WGKV 10 SW	50 ST	1250910000

Type	Qty.	Order No.
SDIS 0.8X4.0X100	1	9008400000

DEK 5/5 / DEK 5/6 / DEK 5/8

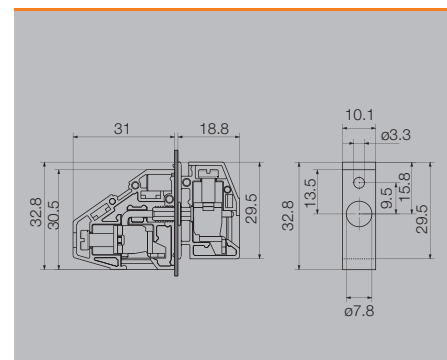

Through-Panel Terminals for devices Series WGK – connects up to 95 mm²

WGK 10 VP

10 mm²

Solder connection



Similar to illustration

Width/Length/External height	mm
Max. current / Max. wire	A/mm ²
Max. clamping range	mm ²

10.1 x 24.5 x
76 / 10
0.22...10

Technical data

Rated data	
Rated voltage	V
Rated current	A
For conductor cross-section	mm ²
Rated impulse withstand voltage / Pollution severity	-/-
Gauge to IEC 60947-1 / UL 94 flammability rating	
Approvals	
Clamped conductors (H05V/H07V)	
Solid / Stranded	mm ²
Flexible / Stranded wire with end ferrules	mm ²
Tightening torque (terminal screw)	Nm
Stripping length / Blade size	mm/-

IEC 60947-7-1

IEC	UL / CUL	CSA
250	300	300
57	65	65
10	AWG 24...6	AWG 24...6
4 kV / 3 B6 / V-0		
CE; CSA; CURUS; GOSTME25; ROHS		

Rated connection	
Solid / Stranded	mm ²
Flexible / Stranded wire with end ferrules	mm ²
Tightening torque (terminal screw)	Nm
Stripping length / Blade size	mm/-

Metal walls: 1 - 4 mm = 500 V Plastic walls: 1 - 4 mm = 500 V

Note

Ordering data

Version	
With locking pins	grey
With locking pins	green/yellow
With locking pins	black
Without locking pins	grey
Without locking pins	green/yellow
Without locking pins	black

Note

Type	Qty.	Order No.
WGK 10 VP/Z	50	1003920000
WGK 10 VP/Z GN/YE	50	1003970000
WGK 10 VP	50	1981880000
WGK 10 VP GN/YE	50	1003960000

Accessories

Distance plate



Screwdriver



Standard

Identification systems (see assortment in catalogue 7)

Marking tags

For detailed information on other accessories and applications, refer to the „Accessories“ section

Type	Qty.	Order No.
DP WGK 10 SW	50	1250570000
DP WGK 10	50	1936440000
SDIS 0.8X4.0X100	1	9008400000

DEK 5/5 / DEK 5/6 / DEK 5/8

Technical drawing

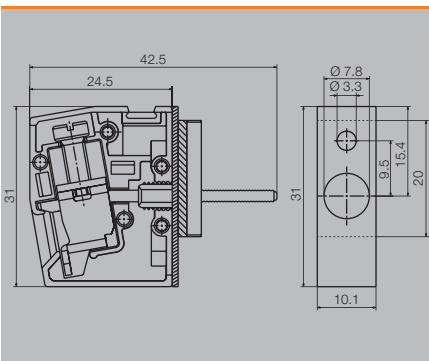

WGK 16

16 mm²

Screw connection

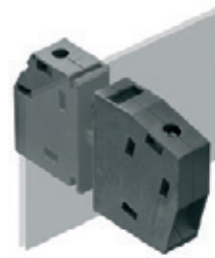

12.1 x 63.5 x 40.4
101 / 25
0.5...25

IEC 60947-7-1

IEC	UL / CUL	CSA
500	600	600
76	85	85
16	AWG 20...4	AWG 20...4
6 kV / 3 B7 / V-0		
CE; CSA; CURUS; GOSTME25; ROHS		

Rated connection	
Solid / Stranded	mm ²
Flexible / Stranded wire with end ferrules	mm ²
Tightening torque (terminal screw)	Nm
Stripping length / Blade size	mm/-

Metal walls: 1 - 2.5 mm = 800 V; 2.5 - 4 mm = 690 V; 4 - 6 mm = 500 V; plastic walls: 1 - 6 mm = 800 V

G

Type	Qty.	Order No.
WGK 16/Z	50 ST	1936830000
WGK 16/Z gn/ye	50 ST	1936820000
WGK 16/Z SW	50 ST	1250870000
WGK 16	50 ST	1936810000
WGK 16 gn/ye	50 ST	1936760000
WGK 16 SW	50 ST	1250860000

Type	Qty.	Order No.
DP WGK 16 SW	50	1250580000
DP WGK 16	50	1936700000
SDIS 1.0X5.5X125	1	9008410000

DEK 5/5 / DEK 5/6 / DEK 5/8

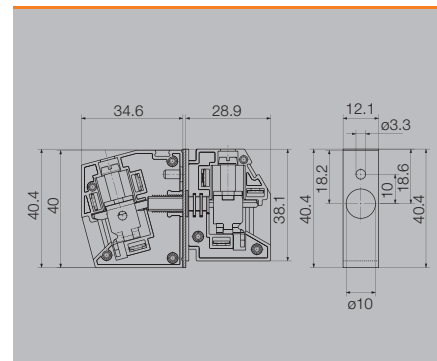

WGK 16 VP

16 mm²

Cable lug connection

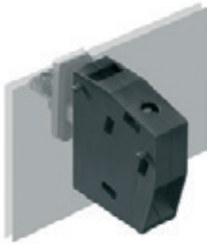

12.1 x 34.6 x 40
101 / 25
0.5...25

IEC 60947-7-1

IEC	UL / CUL	CSA
500	600	600
76	85	85
16	AWG 20...4	AWG 20...4
6 kV / 3 B7 / V-0		
CE; CSA; CURUS; GOSTME25; ROHS		

Rated connection

0.5...16 / 10...25
0.5...16
2...2.3 (M 5)
16 / 1.0 x 5.5 mm

Metal walls: 1 - 2.5 mm = 800 V; 2.5 - 4 mm = 690 V; 4 - 6 mm = 500 V;
plastic walls: 1 - 6 mm = 800 V

Type	Qty.	Order No.
WGK 16 VP/Z	50 ST	1936800000
WGK 16 VP/Z GN/YE	50 ST	1936790000
WGK 16 VP/Z SW	50 ST	1250830000
WGK 16 VP	50 ST	1936780000
WGK 16 VP GN/YE	50 ST	1936770000
WGK 16 VP SW	50 ST	1250820000

Type	Qty.	Order No.
DP WGK 16 SW	50	1250580000
DP WGK 16	50	1936700000
SDIS 1.0X5.5X125	1	9008410000

DEK 5/5 / DEK 5/6 / DEK 5/8

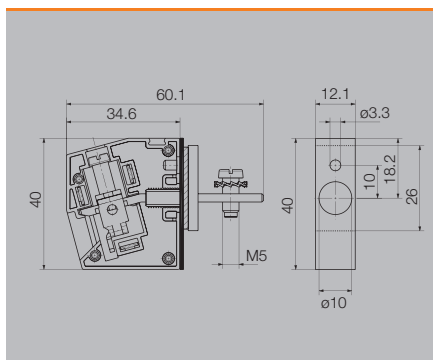

WGKV 16

16 mm²

Screw connection

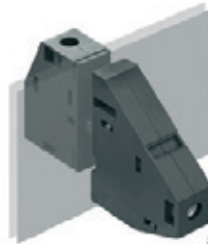

Similar to illustration

12.1 x 63.5 x 39.7
101 / 25
0.5...25

IEC 60947-7-1

IEC	UL / CUL	CSA
500	600	600
76	85	85
16	AWG 20...4	AWG 20...4
6 kV / 3 B7 / V-0		
CE; CSA; CURUS; GOSTME25; ROHS		

Rated connection

0.5...16 / 10...25
0.5...16 / 0.5...16
2...2.3 (M 5)
16 / 1.0 x 5.5 mm

Metal walls: 1 - 2.5 mm = 800 V; 2.5 - 4 mm = 690 V; 4 - 6 mm = 500 V;
plastic walls: 1 - 6 mm = 800 V

Type	Qty.	Order No.
WGKV 16/Z	50 ST	1003940000
WGKV 16/Z GN/YE	50 ST	1003930000
WGKV 16/Z SW	50 ST	1250850000
WGKV 16	50 ST	1003880000
WGKV 16 GN/YE	50 ST	1003950000
WGKV 16 SW	50 ST	1250840000

Type	Qty.	Order No.
SDIS 1.0X5.5X125	1	9008410000

DEK 5/5 / DEK 5/6 / DEK 5/8

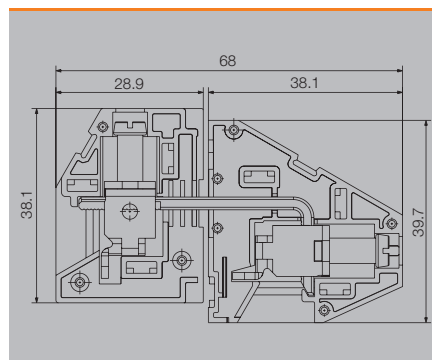

WGK 25

25 mm²

Screw connection



15.1 x 68.5 x 48.5
125 / 35
5.26...35

IEC 60947-7-1

IEC	UL / CUL	CSA
690	600	600
101	100	100
25	AWG 10...3	AWG 10...3
6 kV / 3 B8 / V-0		
CE; CSA; CURUS; GOSTME25; ROHS		

Rated connection

6...16 / 10...35
10...25 / 4...25
4...4.5 (M 6)
18 / 1.2 x 6.5 mm

Metal walls: 1 - 4 mm = 800 V; 4 - 6 mm = 690 V; plastic walls: 1 - 6 mm = 800 V

Type	Qty.	Order No.
WGK 25/Z	50 ST	1936910000
WGK 25/Z GN/YE	50 ST	1936900000
WGK 25/Z SW	50 ST	1250810000
WGK 25	50 ST	1936850000
WGK 25 GN/YE	50 ST	1936840000
WGK 25 SW	50 ST	1250790000

Type	Qty.	Order No.
DP WGK 25 SW	50	1250590000
DP WGK 25	50	1936710000
SDIS 1.2X6.5X150	1	9008420000

DEK 5/5 / DEK 5/6 / DEK 5/8

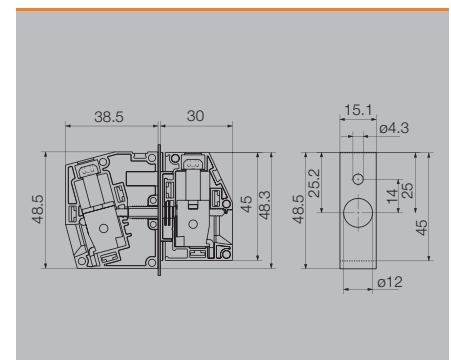

Through-Panel Terminals for devices
Series WGK – connects up to 95 mm²

WGK 25 VP

25 mm²

Cable lug connection

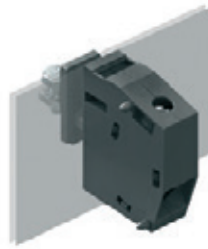

WGKV 25

25 mm²

Screw connection



Similar to illustration

Width/Length/External height	mm
Max. current / Max. wire	A/mm ²
Max. clamping range	mm ²

15.1 x 38.5 x 48.5
125 / 35
5.26...35

15.1 x 75.75 x 54
125 / 35
5.26...35

Technical data

Rated data	
Rated voltage	V
Rated current	A
For conductor cross-section	mm ²
Rated impulse withstand voltage / Pollution severity	-/
Gauge to IEC 60947-1 / UL 94 flammability rating	
Approvals	
Clamped conductors (H05V/H07V)	
Solid / Stranded	mm ²
Flexible / Stranded wire with end ferrules	mm ²
Tightening torque (terminal screw)	Nm
Stripping length / Blade size	mm/-

IEC 60947-7-1

IEC	UL / CUL	CSA
690	600	600
101	100	100
25	AWG 10...3	AWG 10...3
6 kV / 3		
B8 / V-0		
CE; CSA; CURUS; GOSTME25; ROHS		
Rated connection		
6...16 / 10...35		
10...25 / 4...25		
4...4.5 (M 6)		
18 / 1.2 x 6.5 mm		

IEC 60947-7-1

IEC	UL / CUL	CSA
690	600	600
101	100	100
25	AWG 10...3	AWG 10...3
6 kV / 3		
B8 / V-0		
CE; CSA; CURUS; GOSTME25; ROHS		
Rated connection		
6...16 / 10...35		
10...25 / 4...25		
4...4.5 (M 6)		
18 / 1.2 x 6.5 mm		

Note

Metal walls: 1 - 4 mm = 800 V; 4 - 6 mm = 690 V; plastic walls: 1 - 6 mm = 800 V

Metal walls: 1 - 4 mm = 800 V; 4 - 6 mm = 690 V; plastic walls: 1 - 6 mm = 800 V

Ordering data

With assembly peg	
With locking pins	grey
With locking pins	green/yellow
With locking pins	black
Without locking pins	grey
Without locking pins	green/yellow
Without locking pins	black

Type	Qty.	Order No.
WGK 25 VP/Z	50 ST	1936890000
WGK 25 VP/Z GN/YE	50 ST	1936880000
WGK 25 VP/Z SW	50 ST	1250760000
WGK 25 VP	50 ST	1936870000
WGK 25 VP GN/YE	50 ST	1936860000
WGK 25 VP SW	50 ST	1250750000

Type	Qty.	Order No.
WGKV 25/Z	25 ST	1936750000
WGKV 25/Z gn/ye	25 ST	1936740000
WGKV 25/Z SW	25 ST	1250780000
WGKV 25	25 ST	1934070000
WGKV 25 gn/ye	25 ST	1936720000
WGKV 25 SW	25 ST	1250770000

Note

Accessories

Distance plate



Type	Qty.	Order No.
DP WGK 25 SW	50	1250590000
DP WGK 25	50	1936710000

Screwdriver



Standard

Type	Qty.	Order No.
SDIS 1.2X6.5X150	1	9008420000

Type

Type	Qty.	Order No.
SDIS 1.2X6.5X150	1	9008420000

Identification systems

(see assortment in catalogue 7)

Marking tags

DEK 5/5 / DEK 5/6 / DEK 5/8

DEK 5/5 / DEK 5/6 / DEK 5/8

For detailed information on other accessories and applications, refer to the „Accessories“ section

Technical drawing

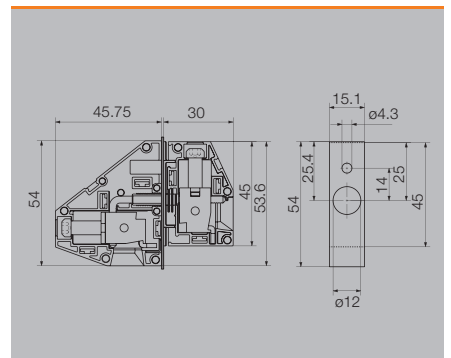
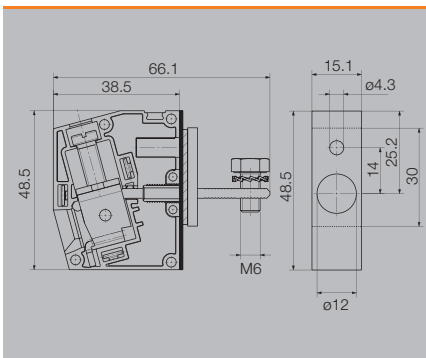

Through-Panel Terminals for devices
Series WGK – connects up to 95 mm²

WGK 95 F VP

95 mm²

Cable lug connection



Width/Length/External height	mm
Max. current / Max. wire	A/mm ²
Max. clamping range	mm ²

25 x 49.5 x 74
232 / 95
35...95

Technical data

Rated data	
Rated voltage	V
Rated current	A
For conductor cross-section	mm ²
Rated impulse withstand voltage / Pollution severity	-/
Gauge to IEC 60947-1 / UL 94 flammability rating	
Approvals	
Clamped conductors (H05V/H07V)	
Solid / Stranded	mm ²
Flexible / Stranded wire with end ferrules	mm ²
Tightening torque (terminal screw)	Nm
Stripping length / Blade size	mm/-

IEC 60947-7-1

IEC	UL / CUL	CSA
690	600	600
232	230	230
95	AWG 4...4	AWG 4...4
8 kV / 3		
B12 / V-0		
CE; CSA; CURUS; GOSTME25; ROHS		

Rated connection	
/ 35...95	
35...95 / 35...95	
15...20 M8/Hexagon	
27 /	

Note

Metal walls: 1 – 2.5 mm = 1000V; 2.5 – 4 mm = 800 V; 4 – 6 mm = 690 V;
 plastic walls: 1 – 6 mm = 1000 V

Ordering data

With assembly peg	
With locking pins	grey
With locking pins	green/yellow
With locking pins	black
Without locking pins	grey
Without locking pins	green/yellow
Without locking pins	black

Type	Qty.	Order No.
WGK 95 F VP/Z	10 ST	1937140000
WGK 95 F VP/Z GN/YE	10 ST	1937360000
WGK 95 F VP/Z SW	10 ST	1250670000
WGK 95 F VP	10 ST	1937130000
WGK 95 F VP GN/YE	10 ST	1937120000
WGK 95 F VP SW	10 ST	1250660000

Note

Accessories

Distance plate



Screwdriver



Standard

Identification systems (see assortment in catalogue 7)

Marking tags

For detailed information on other accessories and applications, refer to the „Accessories“ section

Type	Qty.	Order No.
DP WGK 95 SW	10	1250620000
DP WGK 95	10	1937020000

DEK 5/5 / DEK 5/6 / DEK 5/8

Technical drawing

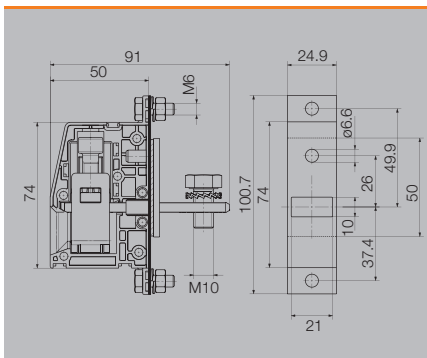

VWGK 4

4 mm²

Solder connection



VWGK 6

6 mm²

Solder connection

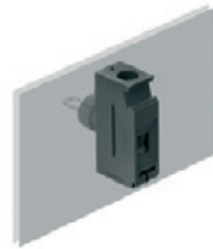

Width/Length/External height	mm
Max. current / Max. wire	A/mm ²
Max. clamping range	mm ²

10 x 11.4 x 20.5
41 / 6
0.22...6

10 x 15.5 x 31.5
57 / 10
0.21...10

Technical data

Rated data	
Rated voltage	V
Rated current	A
For conductor cross-section	mm ²
Rated impulse withstand voltage / Pollution severity	-/
Gauge to IEC 60947-1 / UL 94 flammability rating	
Approvals	
Clamped conductors (H05V/H07V)	
Solid / Stranded	mm ²
Flexible / Stranded wire with end ferrules	mm ²
Tightening torque (terminal screw)	Nm
Stripping length / Blade size	mm/-

IEC 60947-7-1

IEC	UL / CUL	CSA
250	300	300
32	30	30
4	AWG 30...10	...10
6 kV / 3 A3 / V-0		
CE; CSA; CURUS; ROHS		
Rated connection		
0.5...6 / 0.5...4		
0.5...4 / 0.5...4		
0.6...0.8 (M 3)		
8 / 0.6 x 3.5 mm		

IEC 60947-7-1

IEC	UL / CUL	CSA
500	300	300
41	50	50
6	AWG 22...10	...10
6 kV / 3 A5 / V-0		
CE; CSA; CURUS; ROHS		
Rated connection		
0.5...10 / 0.5...6		
0.5...6 / 0.5...6		
0.8...1.8 (M 3.5)		
13 / 0.8 x 4.0 mm		

Note

Metal walls: 1 - 4 mm = 500 V Plastic walls: 1 - 4 mm = 500 V

Metal walls: 1 - 4 mm = 500 V. Plastic walls: 1 - 4 mm = 500 V

Ordering data

With assembly peg	
With locking pins	grey
With locking pins	green/yellow
With locking pins	black
Without locking pins	black
Without locking pins	grey
Without locking pins	black

Type	Qty.	Order No.
VWGK 4	50 ST	1936490000
VWGK 4 GN/YE	50 ST	1936480000
VWGK 4 SW	50 ST	1250650000

Type	Qty.	Order No.
VWGK 6	50 ST	1965740000
VWGK 6 GN/YE	50 ST	1965730000
VWGK 6 SW	50 ST	1250640000

Note

Accessories

Distance plate



Screwdriver



Standard

Identification systems (see assortment in catalogue 7)

Marking tags

For detailed information on other accessories and applications, refer to the „Accessories“ section

Type	Qty.	Order No.
DP VWGK 4 SW	50	1251030000
DP VWGK4	50	1936430000
SDIS 0.6X3.5X100	1	9008390000

Type	Qty.	Order No.
DP VWGK 6 SW	50	1250630000
DP VWGK6	50	1965750000
SDIS 0.8X4.0X100	1	9008400000

KSW 4

DEK 5/5 / DEK 5/6 / DEK 5/8

Technical drawing

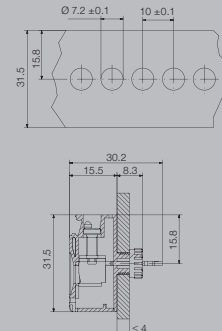
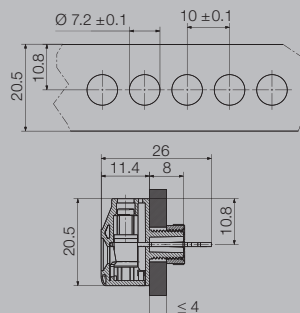

G

OMNIMATE Power Accessories

OMNIMATE Power Accessories

Strain relief	H.2
Shielding	H.3
Coding elements	H.4
Anti-twist mechanism	H.4
Test plug	H.4
Screwdrivers	H.5
Identification systems	H.6

Strain relief

BV/SV 7.62HP/02 ZE GR

Strain relief



BV/SV 7.62HP/04 ZE GR

Strain relief



H

Ordering data

Colour	grey	
Type	Qty.	Order No.
BV/SV 7.62HP/02 ZE GR		1937550000

Ordering data

Colour	grey	
Type	Qty.	Order No.
BV/SV 7.62HP/04 ZE GR		1937560000



BVF 7.62HP SH180 4-6 KIT

Shield support

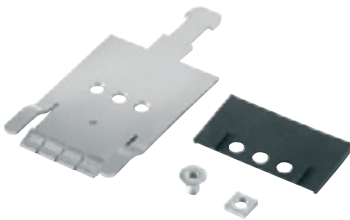

BVF 7.62HP SH150 4-6 KIT

Shield support

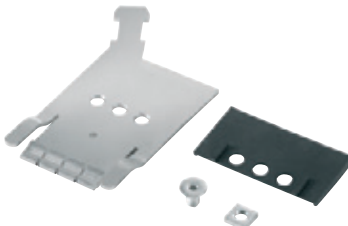

BVF 7.62HP SH150 4-6 KIT

Shield support

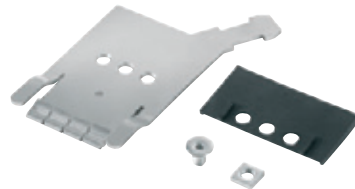

Ordering data

Colour	grey	
Type	Qty.	Order No.
BVF 7.62HP SH180 4-6 KIT		1118470000

Ordering data

Colour	grey	
Type	Qty.	Order No.
BVF 7.62HP SH150 4-6 KIT		1118480000

Ordering data

Colour	grey	
Type	Qty.	Order No.
BVF 7.62HP SH210 4-6 KIT		1118490000

BV/SV 7.62 KO

Coding element



BV/SV 7.62 KO

Anti-twist mechanism



PS 2.0 MC

Test plug

Ø 2.0 mm



- For conductors up to 0.75 mm² (AWG 18).
- Gold-plated lantern-type contact.
- Conductor must be soldered to contact in test plug.

Ordering data

Typ	Qty.	Order No.
BV/SV 7.62HP KO	100	1937590000

Ordering data

Type	Qty.	Order No.
SV 7.62 VDS	1	1853940000

Ordering data

Typ	Wire cross-sections	Qty.	Order No.
PS 2.0 MC	≤ 0,75 mm ²	20	0310000000

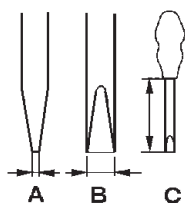

SDI**VDE-insulated slotted screwdriver****VDE-insulated slotted screwdriver, SDI**

- DIN 7437, ISO 2380/2
- Output acc. to DIN 5264, ISO 2380/1
- SoftFinish® handle

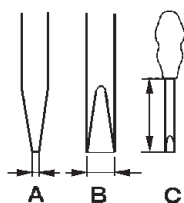
**SD****Slotted screwdriver with round blade****Slotted screwdriver with round blade, SD**

- DIN 5265, ISO 2380/2
- Output acc. to DIN 5264, ISO 2380/1
- ChromTop tip
- SoftFinish® handle

**SDK PH/PZ****Crosshead screwdriver****Crosshead screwdriver PH (Philips)**

- SDK PH DIN 5262, ISO 8764/2-PH
- Output acc. to ISO 8764-PH
- ChromTop tip
- SoftFinish® grip

**Crosshead screwdriver PZ (Pozidrive)**

- SDK PZ DIN 5262, ISO 8764/2-PZ
- Output acc. to ISO 8764-PZ
- ChromTop tip
- SoftFinish® grip

**Ordering data**

Type	Dims. (mm)	A	B	C	Order No.
SDI	0,4	2,5	75		9008370000
SDI	0,5	3,0	100		9008380000
SDI	0,6	3,5	100		9008390000
SDI	0,8	4,0	100		9008400000
SDI	1,0	4,5	125		9008910000
SDI	1,0	5,5	125		9008410000
SDI	1,2	6,5	150		9008420000
SDI	1,6	8,0	175		9008430000

Ordering data

Typ	Dims. (mm)	A	B	C	Order No.
SD	0,4	2,5	75		9009030000
SD	0,5	3,0	80		9008320000
SD	0,6	3,5	100		9008330000
SD	0,8	4,0	100		9008340000
SD	0,8	4,5	125		9009020000
SD	1,0	5,5	150		9008350000
SD	1,2	6,5	150		9009010000

Ordering data PH

Type	Dims. (mm)	A	B	C	Order No.
SDK PH0	0			60	9008470000
SDK PH1	1			80	9008480000
SDK PH2	2			100	9008490000
SDK PH3	3			150	9008500000

Ordering data PZ

Type	Dims. (mm)	A	B	C	Order No.
SDK PZ1	1			80	9008530000
SDK PZ2	2			100	9008540000
SDK PZ3	3			150	9008550000

KSW 4 / KSW 2.5

Marking strips



KSW marking strips are suitable for labelling multi-pole PCB terminals and connectors.

The white, self-adhesive strips are made from a non-PVC, environmentally friendly material. These marking strips provide individual printing, i.e. are suitable for every pitch. Available in two widths: 2.5 and 4.0 mm.

Technical data

Material data	
Material	polyester with white surface
Adhesive	acrylic base
Temperature range	-40 °C to +150 °C
Min. bonding temperature	+4 °C
Flammability	self-extinguishing after 15 s

No. of marking strips per sheet
up to 20 poles = 20 strips per sheet
* more than 20 poles = 15 strips per sheet

Ordering example
Order No. 1630060001

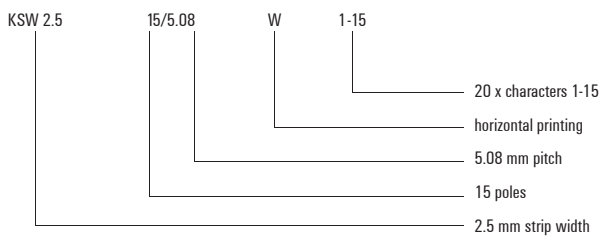

Printed strips

KSW 4		Pitch
Char.	7.62 mm	
1-8	1700680001	
1-12	1652270001	
1-16	-	
1-24*	-	

KSW 2.5		Pitch
Char.	7.62 mm	
1-8	-	
1-12	-	
1-16	-	
1-24*	-	

Blank strips

	Length of strip		
	50 mm	100 mm	150 mm
KSW 4	1629970000	1629990000	1630010000
KSW 2.5	1629960000	1629980000	1630000000

Custom printing to specification

	Length of strip		
	50 mm	100 mm	150 mm
KSW 4	1629910000	1629930000	1629950000
KSW 2.5	1629900000	1629920000	1629940000

Direct printing



We can also print directly on your plug and socket connectors to your specification. Please ask for details.

DEK 5

Dekafix system

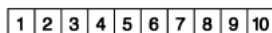

Horizontal printing

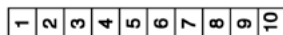

Vertical printing

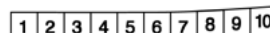

Mounted as strip



Mounted singly

Dekafix is supplied in packs of 10 cards with 50 individual tags per card.

Dekafix tags are white with black printing as standard.

Technical data

Material data	
Material	polyamide
Temperature range	- 40 °C to +100 °C
Flammability rating	UL 94 V-2
Contents	silicone-free, halogens below minimum detectable level self-extinguishing after 15 s
Mounting	as strips or singly depending on type of carrier
Printing	black printing, standard or to customer specification
Smudge resistance	to DIN IEC 50
Custom printing	according to list or data exchange by diskette or modem
Colour	to international colour code
Max. characters DEK 5	3 horizontal/3 vertical up to 2.5 mm font size

Custom printing to specification

Colour	Order No.	Colour	Order No.	Colour	Order No.	Qty. 500
○ white	0490760000	(Note: white has a different order No; otherwise, please state colour when ordering.)				
● black	0490790000	● yellow	0490790000	● violet	0490790000	
● brown	0490790000	● green	0490790000	● grey	0490790000	
● red	0490790000	● blue	0490790000	● orange	0490790000	

Blank

Colour	Order No.	Colour	Order No.	Colour	Order No.	Qty. 500
● black	0473391694	● yellow	0473391687	● violet	0473391689	
● brown	0473391692	● green	0473391688	● grey	0473391691	
● red	0473391686	● blue	0473391693	○ white	0473360000	
● orange	0473391690					

Printed tags

(horizontal only)	Character	Order No.	Character	Horizontal	Vertical										
Tags with individual letters	A	0522761021	50 consecutive numbers	1 ... 50	0473460001										
	B	0522761022	<table border="1"><tr><td>1</td><td>2</td><td>3</td><td>4</td><td>5</td><td>6</td><td>7</td><td>8</td><td>9</td><td>10</td></tr></table>	1	2	3	4	5	6	7	8	9	10	51 ... 100	0473460051
1	2	3	4	5	6	7	8	9	10						
	C	0522761023	<table border="1"><tr><td>11</td><td>12</td><td>13</td><td>14</td><td>15</td><td>16</td><td>17</td><td>18</td><td>19</td><td>20</td></tr></table>	11	12	13	14	15	16	17	18	19	20	to	The last 3 digits of the order No. indicate the first character.
11	12	13	14	15	16	17	18	19	20						
	D	0522761024		951 ... 999	0473460951										
	E	0522761025	10 consecutive numbers	1 ... 10	0523060001										
	F	0522761026	<table border="1"><tr><td>1</td><td>2</td><td>3</td><td>4</td><td>5</td><td>6</td><td>7</td><td>8</td><td>9</td><td>10</td></tr></table>	1	2	3	4	5	6	7	8	9	10	11 ... 20	0523060011
1	2	3	4	5	6	7	8	9	10						
	G	0522761027	<table border="1"><tr><td>11</td><td>12</td><td>13</td><td>14</td><td>15</td><td>16</td><td>17</td><td>18</td><td>19</td><td>20</td></tr></table>	11	12	13	14	15	16	17	18	19	20	to	The last 3 digits of the order No. indicate the first character.
11	12	13	14	15	16	17	18	19	20						
	H	0522761028		91 ... 100	0523060091										
	I	0522761029	Individual numbers	1	0522660001										
	J	0522761030	<table border="1"><tr><td>1</td><td>1</td><td>1</td><td>1</td><td>1</td><td>1</td><td>1</td><td>1</td><td>1</td><td>1</td></tr></table>	1	1	1	1	1	1	1	1	1	1	2	0522660002
1	1	1	1	1	1	1	1	1	1						
	K	0522761031		to	The last 3 digits of the order No. indicate the first character.										
	L	0522761032		200	0522660200										
	M	0522761033	Various symbols	L1, L2, L3, N, PE	0354361187										
	N	0522761034	<table border="1"><tr><td>L1</td><td>L2</td><td>L3</td><td>N</td><td>PE</td><td>L1</td><td>L2</td><td>L3</td><td>N</td><td>PE</td></tr></table>	L1	L2	L3	N	PE	L1	L2	L3	N	PE		
L1	L2	L3	N	PE	L1	L2	L3	N	PE						
	O	0522761035													
	P	0522761036	Single symbols	plus +	0576261198										
	Q	0522761037	<table border="1"><tr><td>+</td><td>+</td><td>+</td><td>+</td><td>+</td><td>+</td><td>+</td><td>+</td><td>+</td><td>+</td></tr></table>	+	+	+	+	+	+	+	+	+	+	minus -	0576261199
+	+	+	+	+	+	+	+	+	+						
	R	0522761038	<table border="1"><tr><td>L1</td><td>L1</td><td>L1</td><td>L1</td><td>L1</td><td>L1</td><td>L1</td><td>L1</td><td>L1</td><td>L1</td></tr></table>	L1	L1	L1	L1	L1	L1	L1	L1	L1	L1	PE	-
L1	L1	L1	L1	L1	L1	L1	L1	L1	L1						
	S	0522761039		L1	0522361075										
	T	0522761040		L2	0522361076										
	U	0522761041		L3	0522361077										
	V	0522761042		earth	0576261202										
	W	0522761043		earth in circle	0576261203										
	X	0522761044		AC ~	0576261215										
	Y	0522761045													
	Z	0522761046													
			Individual card (state characters and orientation when ordering)	0490760000	0490760000										
			Coloured blank Dekafix (state colour when ordering)	0473390000	0473390000										
			Coloured printed Dekafix = custom printing (state colour and characters when ordering)	0490790000	0490790000										

OMNIMATE Housing

Housings for electronics

OMNIMATE Housing Housings for electronics	OMNIMATE Housing		
		Explanation	1.2
		Orientation guide	1.4
<hr/>			
	CH20M		
		Explanation	1.6
		Orientation guide	1.14
		Technical data	1.16
<hr/>			
	MICROBOX / TERMINALBOX		
		Explanation	1.36
		Technical data	1.38
<hr/>			
	Profile housing		
		Explanation	1.40
		Orientation guide	1.42
		Technical data	1.44
<hr/>			

OMNIMATE Housing

Housings for electronics

The perfect platform for form and function – including terminal layouts, bulk products and “tailor-made suits straight off the rack”.

Weidmüller’s electronics provide a state-of-the-art platform for electronics applications: for all design types and usage areas. The application and its requirements are the foundation for the housing design:

Component housings using the standard pitch sizes are particularly well suited for standardised electrical cabinet applications.

Because of their excellent flexibility and variability, profile housings are the perfect solution for custom constructions and small-batch series.

The perfect blend of design, connection technology and functionality result in a design that is well tailored to market and application requirements.

Flexibility

Profile housing – the perfect solution for custom constructions and smallbatch series.

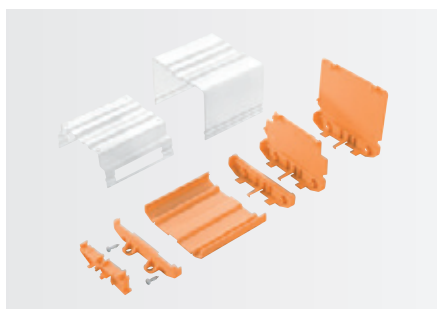

Innovation

Attention to detail: with the integrated, captive “AutoSet” coding function.



Reliability

Weidmüller's legendary quality and well established, proven connection technology guarantee maximum availability for your systems.



Efficiency

Reduce costs and increase productivity: SMT/SMD connectors packed suitably for fully automated production.



Component housing for mounting on rail

Component housing: function, form and processing all contribute to a single cohesive unit that offers safety, manufacturing efficiency and usability.



Assembly housing in profile shape

Assembly housing in profile shape - the flexible modular system of coloured and transparent plastic profiles and support modules provides the optimum balance between flexibility and efficiency.



Accessories

Comprehensive range of system accessories for integrating your assembled electronics "package" into the system environment - from attachment and connection to marking systems.

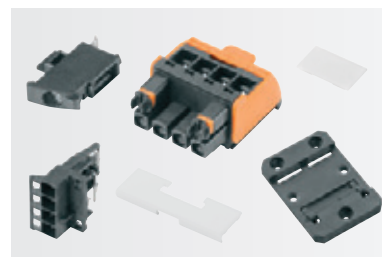

Electronics housings

With 6 housing systems, Weidmüller's electronics housing portfolio offers a platform for electronic applications in any design and for all application areas.

Detailed design information and the most important product-related data is available on the respective product pages. Data sheets and CAD models are available online for download.

CH20M – Modular component housing

Page I.6



System description (key points)

- Scalability
- Widths
- Design
- Production
- Application

Connection system

- Number of conductors that can be connected
- Number of connection levels on each side

Design options

- Housing design

PCB layout

Labelling & marking

Standard housing colours
(Other colours on request)

Additional features

optional (excerpt)

standard (excerpt)

Component housing system IP 20

- 7 housing widths from 6 to 67.5 mm:
- 6,1 / 12,5 / 17,5 / 22,5 / 35¹⁾ / 45 / 67,5
- individually configurable
- 100% reflow soldering compatible (automated)
- networked with mounting rail bus

Connectors (touch-safe both sides)

- 4 - 72
- 1 - 3

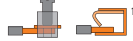

Individually configurable



- asymmetrical port configuration
- individual processing / modification
- large net layout space of up to 9000 mm²
- up to 3 flexibly positioned PCBs
- both sides can be fitted with components (underside: + 5mm)
- Pad & laser printing
- Device markers for female connector
- Device markers for hinged cover



Optional or standard

- Integrated mounting rail bus
- FE mounting rail contact
- Connection areas: lockable slots
- integrated, captive 16-fold "AutoSet" coding
- integrated ejector and plus / minus screws
- "Wire ready" and "wire guard" (protection against mis-inserting)
- transparent hinged cover, sealable

Legend of symbols

-  Clamping yoke screw connection
-  PUSH IN spring connection
-  Tension clamp connection

Note: 1) On request

Housing dimensions (exemplary)

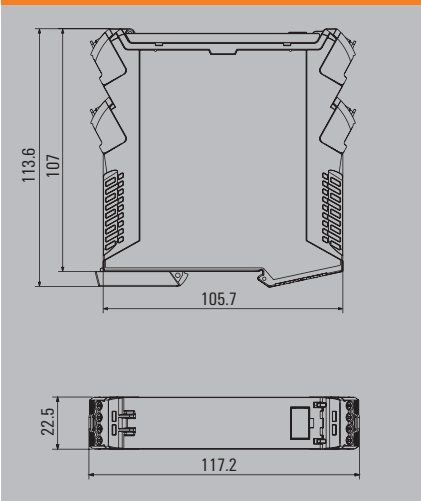

MICROBOX - Small housing
TERMINALBOX - Terminal housing

Page I.36

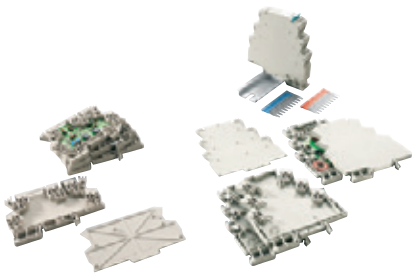

Small housing IP 20

- MICROBOX: 6.1 mm
- TERMINALBOX: 6.0 mm
- Miniature plate housing
- Compact enclosure in terminal format
- e.g. for I/O-plate applications

Connection terminals

- 4 - 6
- 2 - 3

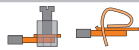

2 versions:

- MICROBOX: closed
- TERMINALBOX optionally with cover plate

- Pad-print printing



Optional:

- Cross-connector 32 A

RS 45-122 Profile housing variable

Page I.42

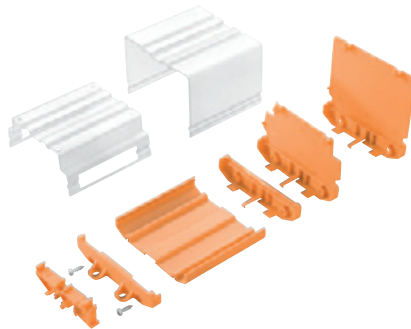

Variable extruded profile case IP 20

- Extruded profile cut to precise length
- Standard length 2m, optionally cut to size
- circuit boards 45 to 122 mm
- precisely cut lengths
- Modules protected with a clear cover

Female connectors or terminals

- as needed
- 1 - 3



Passgenau kombinierbar:

- See-through covers in 2 sizes
- End plates in 3 sizes
- Standard circuit cards (EURO format)
- Up to 2 PCBs stackable
- Double-sided installation
- Pad-print printing
- Standard connector markings
- Marking strips for the cover hood



Optional:

- direct mounting

RS 70 - Profile housing modular

Page I.45



Modular extruded profile case IP 00

- Extruded profile, stackable modular
- Elements of 5 / 10 / 15 / 25 / 30 / 45 mm
- for 68 mm circuit boards
- tool-free installation
- sub-assembly accessible when opened

Female connectors or terminals

- as needed
- 1 - 3



tool-free installation:

- 1 snap-on foot
- 5 different intermediate elements
- Standard circuit boards
- Double-sided installation

- Pad-print printing
- Standard connector markings



Optional:

- direct mounting

Housing dimensions (exemplary)

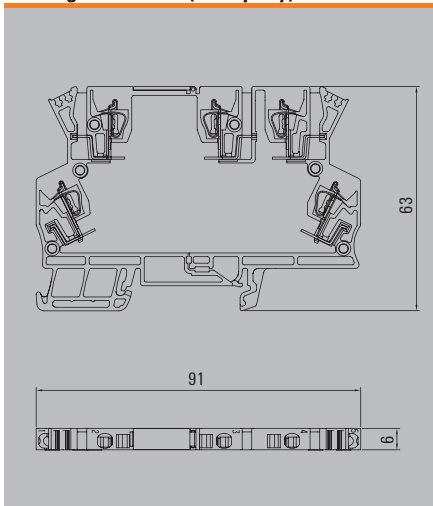

Housing dimensions (exemplary)

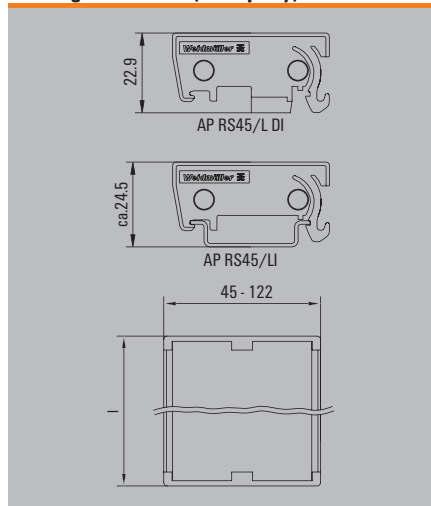

Housing dimensions (exemplary)

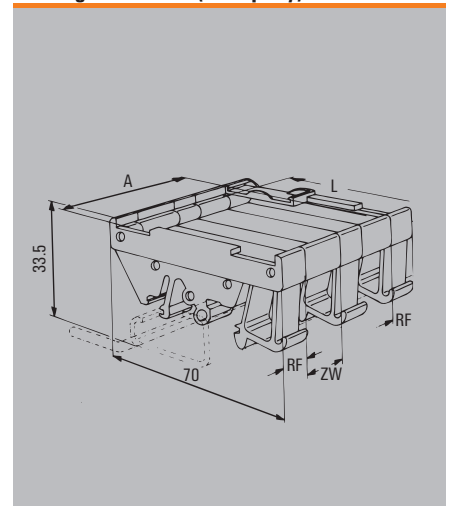

Individual design by combining form, function and appearance

CH20M (Component Housing IP 20 Modular) – Weidmüller’s new housing standard – represents the ideal platform for basing customised electronic applications.

Like a “tailor-made suit straight off the rack”, the ground breaking module concept combines freedom in design with the low cost and planning security of a standard system.

In addition to scalability, a high level of safety and innovative functionality in the application, the system also convinces with superior attention to detail.

The results are quicker installation, user-friendly operation, high operational reliability and resistance to interference. From development to production, the CH20M represents efficiency. It covers all of the requirements for a modern electronics platform built with the future in mind.

Designed configuration

As many connections as you require and as affordable as you need: scalable connection levels, up to 72 wire connections, individually configurable for each side with 1, 2 or 3 connection levels across all housing widths.



Designed basic colours

With a focus on the important elements: the unobtrusive housing colours (black graphite, grey graphite and light grey) make a competent impression without distracting from the key operational and display elements.



Designed printing

Detailed symbols, data, graphics or text can be printed (with either laser or pad printing) on the large surface available on the housing element.



Designed optical appearance

The standard variants, with their modularity and variety, enable you to customise a wide range of designs to fit your application.



Designed functionality

Our comprehensive, standardised configuration variants can be further supplemented with modification and design changes to fit your custom needs.

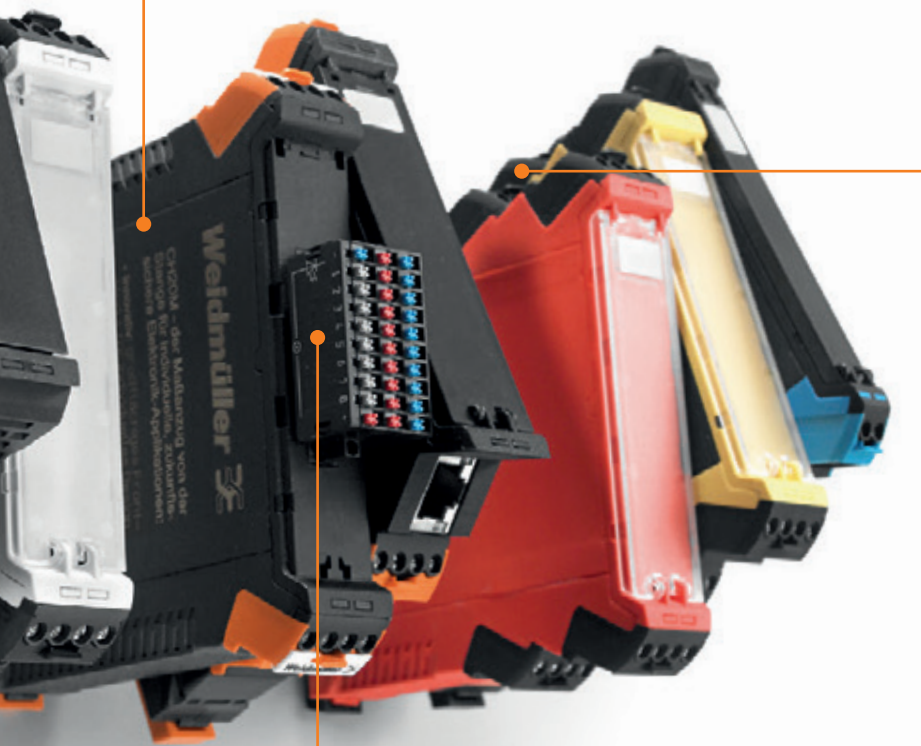

Designed modifications

Modifying after the configuration: for example by integrating the pluggable 30-pole BL-I/O LED digital I/O connection level in the front or with the RJ45 socket on the side.



Designed functional colours

More operational confidence with functionally appropriate colour coding: three functional colours (red, yellow and blue coding) can be assigned to key industrial applications.



Power, signals and data are provided, connected and distributed securely and consistently

This customer-friendly bus solution brings power, signals and data to the rail in a quick and reliable manner. When supplying, connecting or distributing within modular applications, the rail bus can replace the tedious individual wiring process with a flexible and uninterrupted system solution. As a result, the wiring overhead and the error rate are both reduced. Redundant functions within complex applications can be efficiently centralised or intelligently distributed.



The system bus is securely integrated within the 35 mm standard mounting rail. The SMD-bus contact block can be reflow-soldered so that it can be completely automatically processed during the component assembly. The resistant, gold-plated contact surfaces ensure a permanent and reliable contact for all housing widths.

Scalability with no limits

Unique: The integrated connection solution covers all system widths: from the 6 mm slice to the 67 mm large-area housing.



Easy to service during installation:

Quick: It's easy to replace a module, even in existing modules groups - without any influence on the neighbouring modules.



Unlimited configuration

Compatible: The individual modules can be positioned anywhere on any TS-35 standard top-hat rail. Unused areas are safely covered.

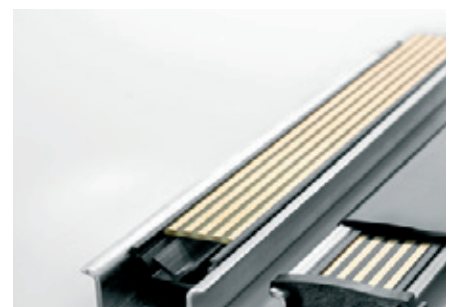

Maximum availability:

Reliable: Five fully-galvanised and partially gold-plated twin-arched contacts are used to establish a permanent contact to the rail bus. THR solder flanges ensure that the connection to the circuit board is stable.

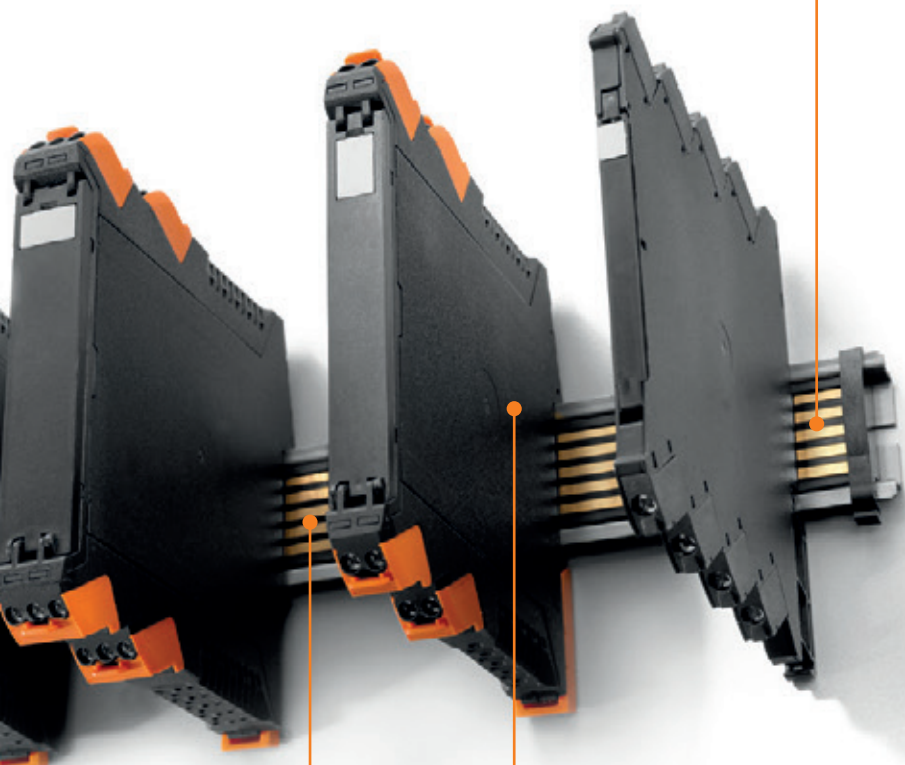
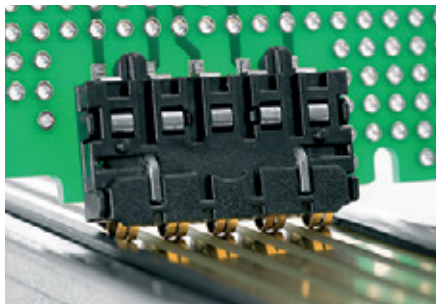

State-of-the-art processing

Efficient: The SMD-compatible bus contact block is made from high-temperature-resistant LCP. It is designed for the SMT reflow process and is delivered in machine-ready packaging.

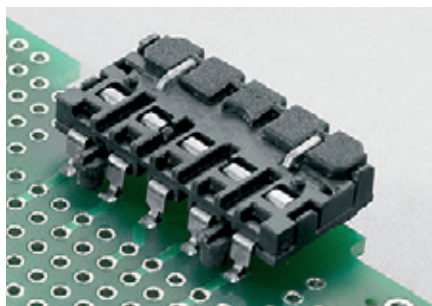

Affordable assembly

Fully automatic: No manual post processing is required for the bus contact block – it is processed with the assembly group in a single SMT assembly process.

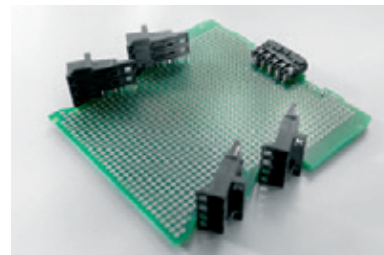

Safe installation

Low loss: You can safely avoid undesired bus interruptions and high contact resistances. Maximum facility availability ensured by the gold-plated contact surfaces on the system bus and contact block, as well as the consistent system design.



More flexibility in design

From design through production to application - CH20M6 sets the market standard with maximal board space with minimal exterior dimensions as well as allowing fully automatic reflow processing or bus connections.

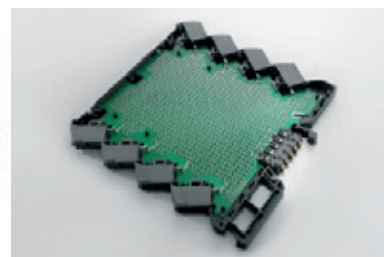

OMNIMATE Housing – CH20M-67

The new housing offers new assembly dimensions in the 67.5 mm equipment class.

The CH20M-67 sets new standards on the market as a large-scale housing in terms of flexibility for integrating intricate electronic subassemblies. You can distribute the electronic functions over as many as three printed-circuit boards. The front surface of the housings also has a unique size that can be used for freely laying out the operator interface.

Like all housings of the CH20M family from Weidmüller, the CH20M-67 also supports the connection to the mounting rail bus. The system bus is reliably integrated into the 35-mm standard mounting rail and replaces painstaking and error-prone individual wiring.

More reliability when connecting the conductors

Series equipment: The built-in conductor wire guard underinsertion protection prevents the hazardous underinsertion of the conductor and protects it from concealed contact faults. Being wire ready ensures that all connecting points are completely open at delivery.



More speed at installation

Series equipment: Screwed connections with wiring, supported by plus-minus screws, with power tools just right for automatic equipment.

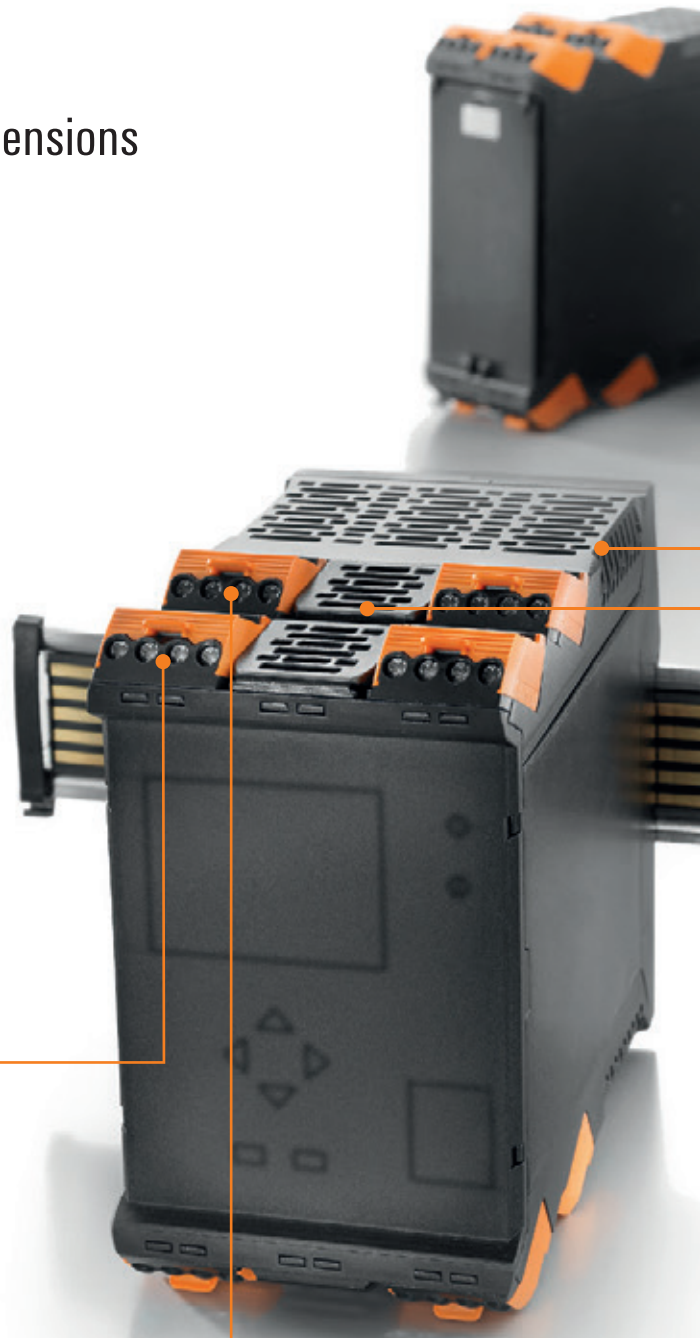

More layout area

The side ventilation openings are standard equipment in the semi-cooling design and provide sufficient convection for demanding electronics with the maximised layout area on the printed-circuit board.



More flexibility for interfaces

Unused plug-in stations or connections that are only accessible from the factory side can be reliably and permanently sealed with the optional AD-SHL-SMT cover.

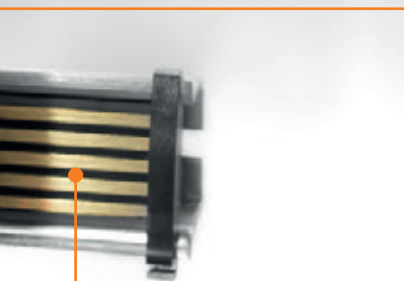

More stability on the mounting rail

The built-in click-in base is premounted at the factory which guarantees easy, reliable and vibration-free fastening on the DIN mounting rail. A guide with four points of support provides a solid base.



More design freedom

There is room for one to three printed-circuit boards placed on both sides CH20M-67. There is maximum design flexibility since each printed-circuit board can take four freely selectable positions in the housing.

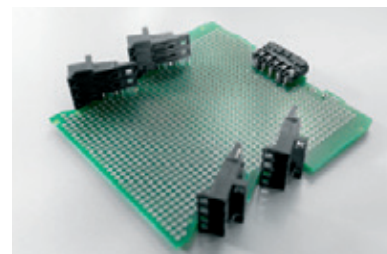

More mounting space

The printed-circuit boards can be positioned at a distance of 2.3 mm (and also 5 mm to the housing wall). This gives you the free choice of single- or double-sided assembly.



OMNIMATE Housing – System CH20M

System overview

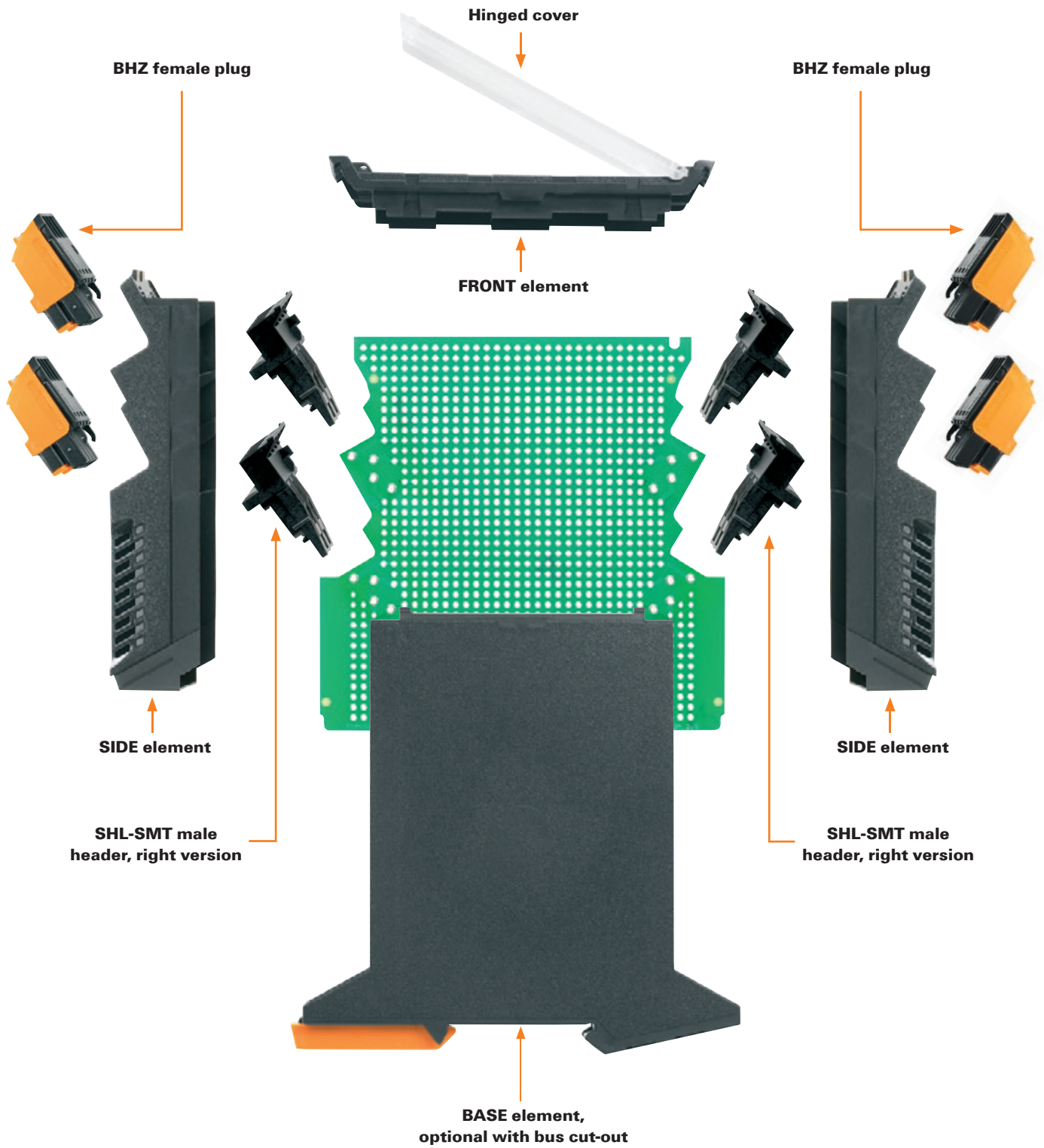



Hinged cover, transparent **CH20M22 C TP**
on FRONT element, black **CH20M22 F BK**



Hinged cover, black **CH20M22 C BK**



FRONT element, black **CH20M22 F BK**



FRONT element, black:
for use without hinged cover
CH20M22 FC BK

Connection area (SIDE) with 1-3 levels

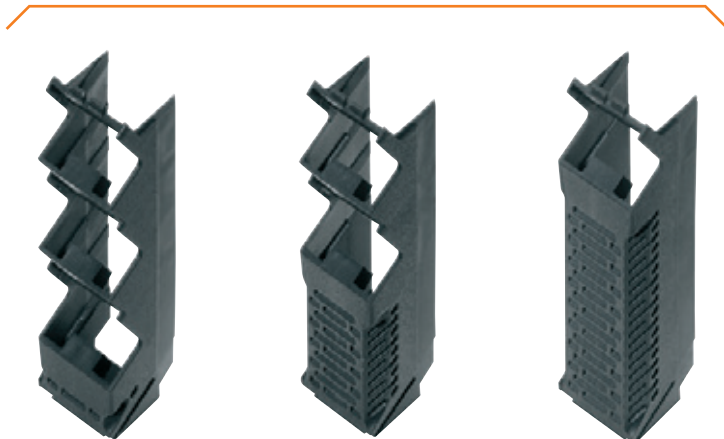

Black SIDE element
3-row 12 connections
CH20M22 S PPP BK

Black SIDE element
2-row 8 connections
CH20M22 S PPSC BK

Black SIDE element
1-row 4 connections
CH20M22 S PSCSC BK

Connection area (SIDE) with 1-3 levels and
varying connection configurations



Black SIDE element
1-row 8 connections-
CH20M45 S P2SC/P2SC BK

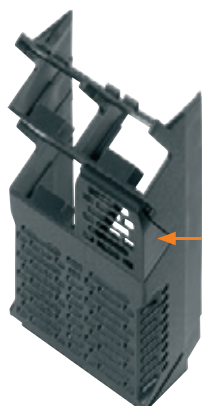

Black SIDE element
2-row 16 connections
CH20M45 S 2PSC/2PSC BK,
incl. Male header
CH20M AD-SHL

AD-SHL



Black SIDE element
2-row 8 connections
CH20M45 S 2PSC/3SC BK

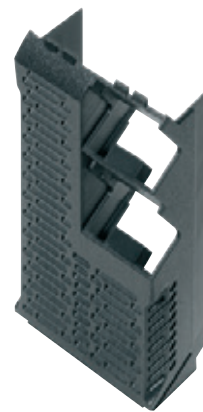

Black SIDE element
2-row 8 connections
CH20M45 S 3SC/2PSC BK

OMNIMATE Housing







Component housing system CH20M

The module electronics housing system – CH20M (**C**omponent **H**ousings **IP20 M**odular) – is designed for seven widths.

Width	Type	Sample kit including wire connection mechanism	Catalogue pages
6.1 mm	CH20M6	1203290000 CH20M6 S-Kit	I.16
12.5 mm	CH20M12	1167190000 CH20M12 S-Kit	I.18
17.5 mm	CH20M17	1255820000 CH20M17 S-Kit	I.20
22.5 mm	CH20M22	1158390000 CH20M22 S-Kit	I.22
35 mm	CH20M35	On request	
45 mm	CH20M45	1203350000 CH20M45 S-Kit	I.24
67 mm	CH20M67	On request	I.26









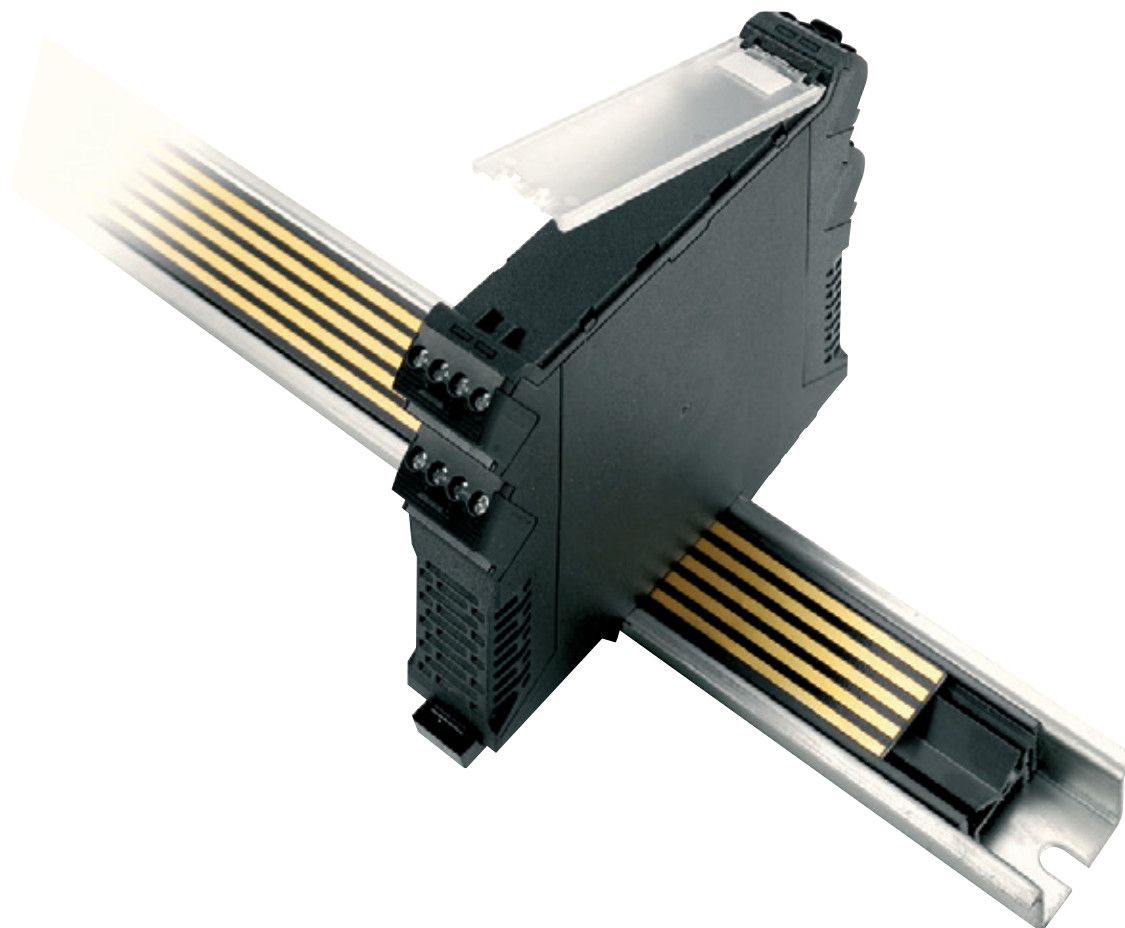









































Note: The sample kit contains all individual parts for setting up a housing, including the circuit board and wire connection mechanism.

Colour scale¹⁾

	Similar to RAL 9011
	Similar to RAL 7024
	Similar to RAL 7035
	Similar to RAL 5012
	Similar to RAL 1003
	Similar to RAL 3000

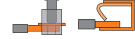
Note 1) Other colours on request

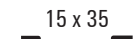

Housing elements	Description / Type	Design options
Hinged cover 	COVER (CH20Mxx C xx) <ul style="list-style-type: none"> Transparent (light or dark) Holds itself in place when opened Sealable 	 Transparent  • pad printing  123 • markable  • machinable
Housing front 	FRONT (CH20Mxx F xx) <ul style="list-style-type: none"> Large usable surface for the operational and display elements Can be customised 	      ¹⁾   • laser marking  123 • With hinges for cover  • Optionally closed (without hinged cover)
Connection area 	SIDE (CH20Mxx S xx) SIDE element: <ul style="list-style-type: none"> 1 - 3 connection levels Can be configured asymmetrically For up to 3 circuit boards Up to 72 wires can be connected 	      ¹⁾   • laser marking  • 1 - 3 plugging levels  • Up to 3 circuit boards, can be populated on both sides up to 5 mm on bottom of board  • with or without bus cut-out
Housing base 	BASE (CH20Mxx B xx) BASE element: <ul style="list-style-type: none"> For TS 35 DIN rails Pre-attached snap-on foot ESD-protected (8kV acc. to EN 61000-4-2) All elements are permanently snapped in 	      ¹⁾   • laser marking  123 • with or without bus cut-out  • Optional FE contact  • Snap-on foot in 2 standard colours (orange + black)
Connection system 	BHZ female plug / SHL male header Female plug / male header: <ul style="list-style-type: none"> Reflow compatible Can be automatically processed Integrated "AutoSet" coding Release clip is standard 	   ¹⁾   • Headers packaged in box or on tape  123 • Clamping yoke screw connection  • PUSH IN spring connection (on request)
Rail bus 	Bus Non-interrupted system bus: <ul style="list-style-type: none"> Integrated in TS 35 DIN rail For power, signals and data 5 conductor paths (max. 5 A / 63 V) SMD-compatible bus contacts (2 A / 63 V) 	 7.5 x 35 • Can be shortened to length  • For 7.5 and 15 mm with finger-safe hood  15 x 35 • Pre-assembled on request

  printable (pad printing / laser marking),
  123 markable,
  machinable,
  variable circuit board position

CH20M6



Modular component housing for electronic components

- 6.1mm wide
- Connection method: PCB terminals, clamping yoke screw connection
- Max. 8 wires

Technical data

Insulating material	PBT
Flammability rating (UL94)	V0
Rated voltage	250 V AC
Rated current	13 A

Demo Kit

Type / Version	Qty.	Order No.
SK DEMO CH20M6	1	1203310000

Dimensional drawing

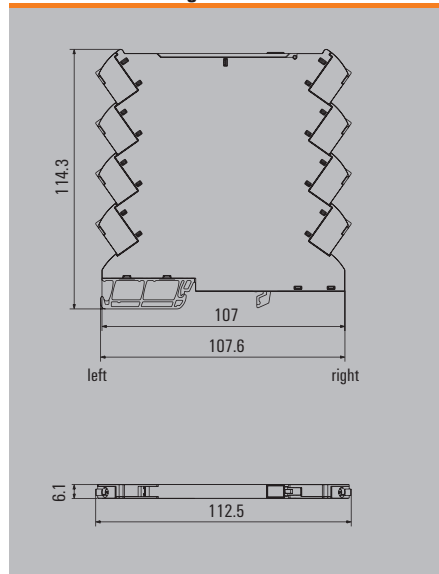

CH20M6 BP

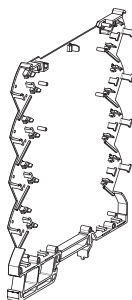

Base shell



Base shell

- For mounting on rail
- Optionally with BUS cut-out

Ordering data

Type / Version	Qty.	Order No.
 Base housing, black CH20M6 BP 4P-4P BK	50	2418600000
 Base housing BUS black CH20M6 BP 4P-4P BUS BK	50	1164630000
 Base housing FE black CH20M6 BP 4P-4P FE BK	50	1164650000

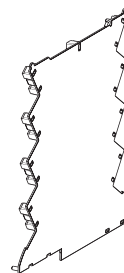

CH20M6 BC

Base lid



Base lid

Ordering data

Type / Version	Qty.	Order No.
 black CH20M6 BC 4P-4P BK	50	2418610000
 black CH20M6 BC 4P-4P BUS BK	50	1164640000



CH20M6 C

Hinged cover



Hinged cover

Ordering data

Type / Version	Qty.	Order No.
 dark transparent CH20M6 C BK	50	2418620000
 transparent CH20M6 C TP	50	1073410000

Connection system

and accessories

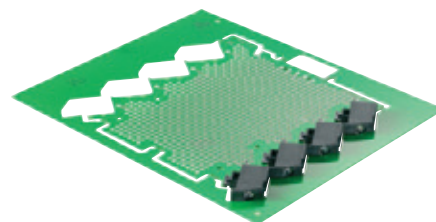

PCB terminal

Type / Version	Qty.	Order No.
Left, box packaging LHZ-SMT L 1.5SN BK BX	50	1137870000
Right, box packaging LHZ-SMT R 1.5SN BK BX	50	1137880000
Left, tape-on-reel LHZ-SMT L 1.5SN BK RL	432	2418580000
Right, tape-on-reel LHZ-SMT R 1.5SN BK RL	432	2418590000

Markers

Type / Version	Qty.	Order No.
Device marker hinged cover MF 5/7,5 MC NEUTRAL	50	1877680000

CH20M12



Modular component housing for electronic components

- 12.5 mm wide
- Pluggable wire connection
- Max. 12 wires

Technical data

Insulating material	PA6.6
Flammability rating (UL94)	V0
Rated voltage	250 V AC
Rated current	10 A

Demo Kit

Type / Version	Qty.	Order No.
SK DEMO CH20M12	1	1111630000

Dimensional drawing

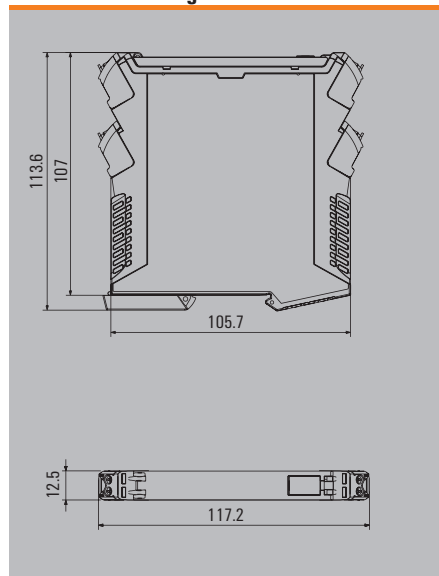

CH20M6 BP

BASE element



BASE



Base element with pre-attached snap-on foot

- Optionally with BUS cut-out
- Optionally with FE cut-out

CH20M12 S

SIDE element



SIDE



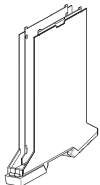
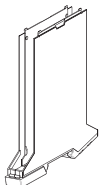
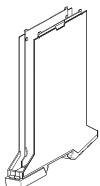
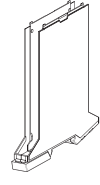

Side element

Ordering data

Type / Version	Qty.	Order No.
 Base element, black, Snap-on foot, black CH20M12 B BK/BK	14	1104170000
 Base element, black, Snap-on foot, orange CH20M12 B BK/OR	14	1104180000
 Base element, black, BUS, Snap-on foot, orange CH20M12 B BUS BK/OR	14	1176980000
 Base element, black, FE (Version for functional earth), Snap-on foot, orange CH20M12 B FE BK/OR	14	1176990000

Ordering data

Type / Version	Qty.	Order No.
 Side element, black, 1-row., for 2 connections* CH20M12 S PSCSC BK	14	1104210000
 Side element, black, 2-row., for 4 connections CH20M12 S PPSC BK	14	1104200000
 Side element, black, 3-row., for 6 connections CH20M12 S PPP BK	14	1174280000

*) The side itself does not have any connections

CH20M12 F

FRONT Element

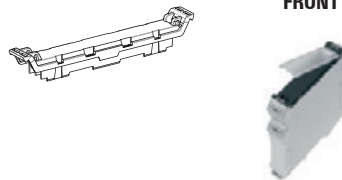

Front element

CH20M12 C

COVER Element

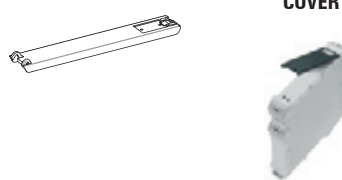

Hinged cover

Connection system

and accessories

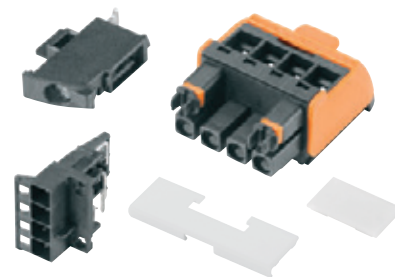

Female plug 2-pole, black,
Male header 2-pole, black,
Left and right versions of header

Ordering data

Type / Version	Qty.	Order No.
 Front element black CH20M12 F BK	70	1104190000

Ordering data

Type / Version	Qty.	Order No.
 Hinged cover, dark transparent CH20M12 C BK	70	1104240000
 Hinged cover, transparent CH20M12 C TP	70	1104250000

Female plug

Type / Version	Qty.	Order No.
Release lever, orange BHZ 5.00/02/90LH BK/DR	150	1063260000
Release lever, black BHZ 5.00/02/90LH BK/BK	150	1069330000
Release lever, blue BHZ 5.00/02/90LH BK/BL	150	1069360000

Male header

Type / Version	Qty.	Order No.
Left version, box packaging SHL-SMT 5.00/02GL 4.2BX	156	1069620000
SHL-SMT 5.00/02GL 5.9BX	156	1069750000
Right version, box packaging SHL-SMT 5.00/02GR 4.2BX	156	1069550000
SHL-SMT 5.00/02GR 5.9BX	156	1069680000
Left version, tape-on-reel SHL-SMT 5.00/02GL 4.2RL	260	1069650000
SHL-SMT 5.00/02GL 5.9RL	260	1069780000
Right version, tape-on-reel SHL-SMT 5.00/02GR 4.2RL	260	1069580000
SHL-SMT 5.00/02GR 5.9RL	260	1069720000

Plug cover

Type / Version	Qty.	Order No.
Cover, black 2-pole CH20M AD SHL 5.00/02 BK		On request

Markers

Type / Version	Qty.	Order No.
Device marker hinged cover ESG 8/13.5/43.3 SAI AU	5	1912130000
Device marker Female plug ESG 6.6/11 BHZ 5.00/02	200	1082490000

CH20M17



Modular component housing for electronic components

- 17.5 mm wide
- Pluggable wire connection
- Max. 18 wires

Technical data

Insulating material	PA6.6
Flammability rating (UL94)	V0
Rated voltage	250 V AC
Rated current	10 A

Demo Kit

Type / Version	Qty.	Order No.
SK DEMO CH20M17	1	On request

Dimensional drawing

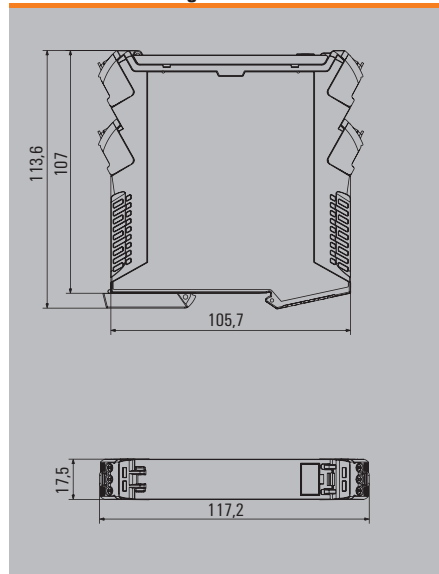

CH20M17 B

BASE element

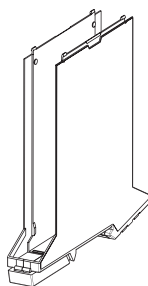

BASE



Base element with pre-attached snap-on foot

- Optionally with BUS cut-out
- Optional with cut-out for functional earth (FE)

CH20M17 S

SIDE element



SIDE



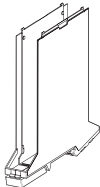
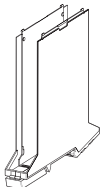
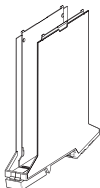
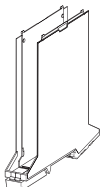

Side element

Ordering data

Type / Version	Qty.	Order No.
 Base element, black, Snap-on foot, black CH20M17 B BK/BK	12	1254120000
 Base element, black, Snap-on foot, orange CH20M17 B BK/OR	12	1254130000
 Base element, black, BUS, Snap-on foot, orange CH20M17 B BUS BK/OR	12	1254180000
 Base element, black, FE, Snap-on foot, orange CH20M17 B FE BK/OR	12	1254190000

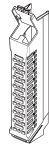
Ordering data

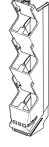
Type / Version	Qty.	Order No.
 Side element, black, 1-row, 3 connections CH20M17 S PSCSC BK		On request
 Side element, black, 2-row, 6 connections CH20M17 S PPSC BK		On request
 Side element, black, 3-row, 9 connections CH20M17 S PPP BK	12	1254170000

CH20M17 F

FRONT element

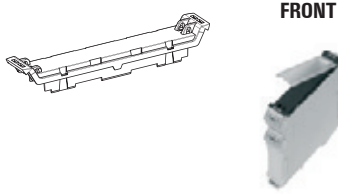

Front element

CH20M17 C

COVER element

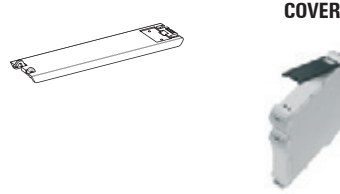

Hinged cover

Connection system

and accessories

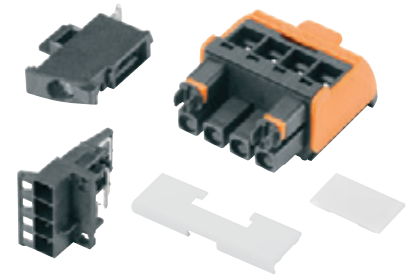

Female plug 3-pole, black
Male header 3-pole, black,
Left and right versions of header

Ordering data

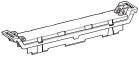
Type / Version	Qty.	Order No.
 Front element, black CH20M17 F BK	50	1254140000

Ordering data

Type / Version	Qty.	Order No.
 Hinged cover, dark transparent CH20M17 C BK	50	1254150000
 Hinged cover, transparent CH20M17 C TP	50	1254160000

Female plug

Type / Version	Qty.	Order No.
Release lever, orange BHZ 5.00/03/90LH BK/DR	108	1063270000
Release lever, black BHZ 5.00/03/90LH BK/BK	108	1069340000
Release lever, blue BHZ 5.00/03/90LH BK/BL	108	1069370000

Male header

Type / Version	Qty.	Order No.
Left version, box packaging SHL-SMT 5.00/03GL 1.5BX	120	1063210000
SHL-SMT 5.00/03GL 4.2BX	120	1069630000
SHL-SMT 5.00/03GL 5.9BX	120	1069760000
Right version, box packaging SHL-SMT 5.00/03GR 1.5BX	120	1063140000
SHL-SMT 5.00/03GR 4.2BX	120	1069560000
SHL-SMT 5.00/03GR 5.9BX	120	1069690000
Left version, tape-on-reel SHL-SMT 5.00/03GL 1.5RL	175	1063240000
SHL-SMT 5.00/03GL 4.2RL	175	1069660000
SHL-SMT 5.00/03GL 5.9RL	175	1069790000
Right version, tape-on-reel SHL-SMT 5.00/03GR 1.5RL	175	1063170000
SHL-SMT 5.00/03GR 4.2RL	175	1069590000
SHL-SMT 5.00/03GR 5.9RL	175	1069730000

Plug cover

Type / Version	Qty.	Order No.
Cover, black 3-pole CH20M AD SHL 5.00/03 BK	50	1254110000

Markers

Type / Version	Qty.	Order No.
Device marker hinged cover ESG 8/13.5/43.3 SAI AU	5	1912130000
Device marker Female plug ESG 6.6/15 BHZ 5.00/03	200	1082520000

CH20M22



- Modular component housing for electronic components
- 22.5 mm wide
 - Pluggable wire connection
 - Max. 24 wires

Technical data

Insulating material	PA6.6
Flammability rating (UL94)	V0
Rated voltage	250 V AC
Rated current	10 A

Demo Kit

Type / Version	Qty.	Order No.
SK DEMO CH20M22	1	1105600000

Dimensional drawing

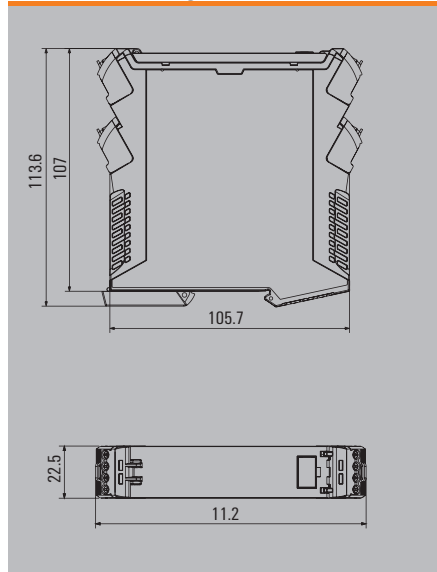

CH20M22 B

BASE element

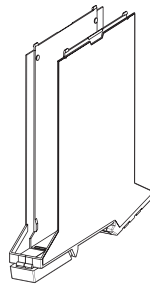

BASE



- Base element with pre-attached snap-on foot
- Optionally with BUS cut-out
 - Optional with cut-out for functional earth (FE)

Ordering data

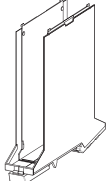
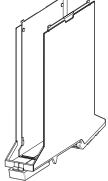
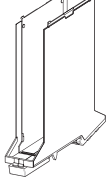
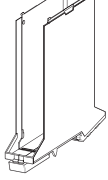
Type / Version	Qty.	Order No.
 Base element, black, Snap-on foot, black CH20M22 B BK/BK	10	2418630000
 Base element, black, Snap-on foot, orange CH20M22 B BK/OR	10	1104450000
 Base element, black, BUS, Snap-on foot, orange CH20M22 B BUS BK/OR	10	1177000000
 Base element, black, FE, Snap-on foot, orange CH20M22 B FE BK/OR	10	1177010000

CH20M22 S

SIDE element





SIDE

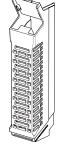

Side element

Ordering data

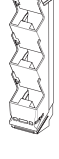
Type / Version	Qty.	Order No.
 Side element, black, 1-row, 4 connections CH20M22 S PSCSC BK	10	1080630000
 Side element, black, 2-row, 8 connections CH20M22 S PPSC BK	10	2418650000
 Side element, black, 3-row, 12 connections CH20M22 S PPP BK	10	1139790000

CH20M22 F

FRONT element

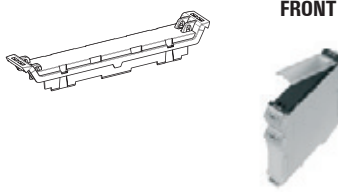

Front element

CH20M22 C

COVER element

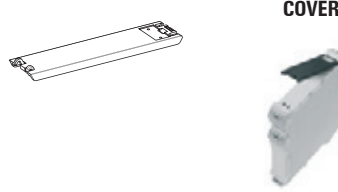

Hinged cover

Connection system

and accessories

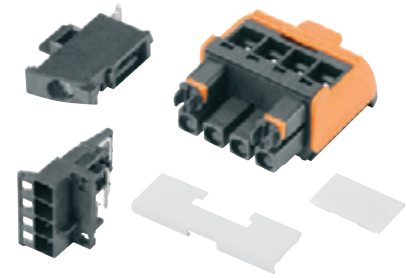

Female plug 4-pole, black
Male header 4-pole, black,
Left and right versions of header

Ordering data

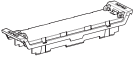
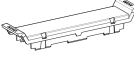
Type / Version	Qty.	Order No.
 Front element, black CH20M22 F BK	50	2418640000
 Front element, closed, black CH20M22 FC BK	50	1209350000

Ordering data

Type / Version	Qty.	Order No.
 Hinged cover, dark transparent CH20M22 C BK	50	2418670000
 Hinged cover, transparent CH20M22 C TP	50	1073420000

Female plug

Type / Version	Qty.	Order No.
Release lever, orange BHZ 5.00/04/90LH BK/DR	150	1063280000
Release lever, black BHZ 5.00/04/90LH BK/BK	150	1069350000
Release lever, blue BHZ 5.00/04/90LH BK/BL	150	1069380000

Male header

Type / Version	Qty.	Order No.
Left version, box packaging SHL-SMT 5.00/04GL 1.5BX	120	1063220000
SHL-SMT 5.00/04GL 4.2BX	120	1069640000
SHL-SMT 5.00/04GL 5.9BX	120	1069770000
Right version, box packaging SHL-SMT 5.00/04GR 1.5BX	120	1063150000
SHL-SMT 5.00/04GR 4.2BX	120	1069570000
SHL-SMT 5.00/04GR 5.9BX	120	1069710000
Left version, tape-on-reel SHL-SMT 5.00/04GL 1.5RL	130	1063250000
SHL-SMT 5.00/04GL 4.2RL	130	1069670000
SHL-SMT 5.00/04GL 5.9RL	130	1069810000
Right version, tape-on-reel SHL-SMT 5.00/04GR 1.5RL	130	1063180000
SHL-SMT 5.00/04GR 4.2RL	130	1069610000
SHL-SMT 5.00/04GR 5.9RL	130	1069740000

Plug cover

Type / Version	Qty.	Order No.
Cover, black 4-pole CH20M AD SHL 5.00/04 BK	50	1221310000

Markers

Type / Version	Qty.	Order No.
Device marker hinged cover ESG 8/13.5/43.3 SAI AU	5	1912130000
Device marker Female plug ESG 6.6/20 BHZ 5.00/04	200	1082540000

CH20M45



Modular component housing for electronic components

- 45 mm wide
- Pluggable wire connection
- Max. 48 wires

CH20M45 B

BASE element

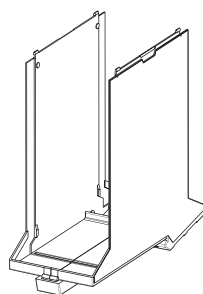

BASE



Base element with pre-attached snap-on foot

- Optionally with BUS cut-out
- Optional with cut-out for functional earth (FE)

CH20M45 S

SIDE element

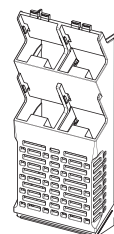

SIDE



Side element

- Symmetrical versions

Technical data

Insulating material	PA6.6
Flammability rating (UL94)	V0
Rated voltage	250 V AC
Rated current	10 A

Ordering data

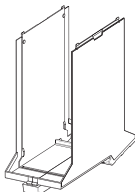
Type / Version	Qty.	Order No.
 Base element, black, Snap-on foot, black CH20M45 B BK/BK	10	1104400000

Ordering data

Type / Version	Qty.	Order No.
 Side element, black, 1-row, 8 connections CH20M45 S P2SC/P2SC BK	6	1166180000

Demo Kit

Type / Version	Qty.	Order No.
SK DEMO CH20M45	1	1111640000

Dimensional drawing

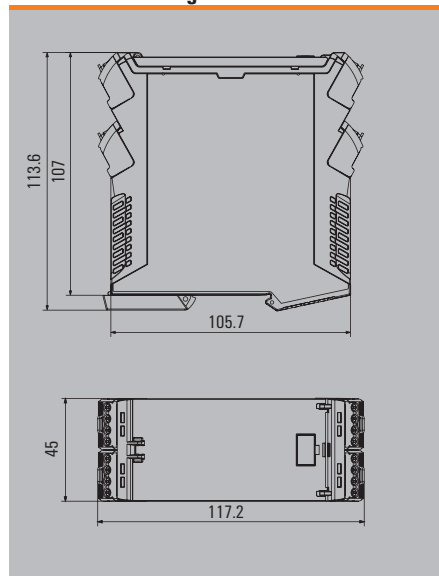

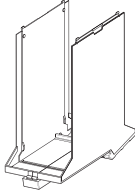
 Base element, black, Snap-on foot, orange CH20M45 B BK/OR	10	1104410000
--	----	------------

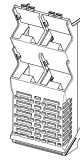
 Side element, black, 2-row, 16 connections CH20M45 S 2PSC/2PSC BK	6	1111720000
--	---	------------

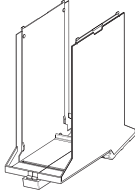
 Base element, black, BUS, Snap-on foot, orange CH20M45 B BUS BK/OR	10	1177020000
---	----	------------

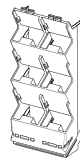
 Side element, black, 3-row, 24 connections CH20M45 S 3P/3P BK	6	1137730000
--	---	------------

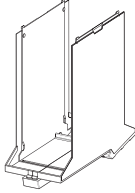
 Base element, black, FE, Snap-on foot, orange CH20M45 B FE BK/OR	10	1177030000
---	----	------------

CH20M45 S

SIDE element

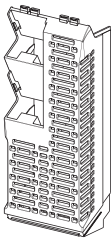

Side element
• Asymmetrical versions

CH20M45 C / CH20M45 F

**COVER element
FRONT element**

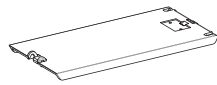

Hinged cover

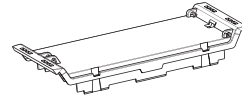

Front element

COVER



FRONT



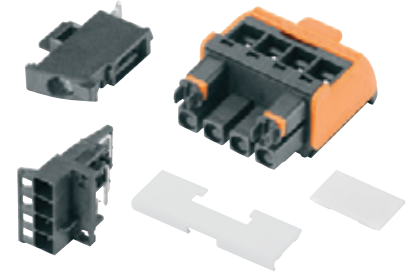

Connection system

and accessories



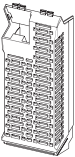

Female plug 4-pole, black,
Male header 4-pole, black,
Left and right versions of header

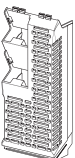
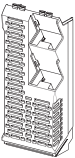
Ordering data

Type / Version	Qty.	Order No.
 Side element, black, 1-row, 4 connections CH20M45 S P2SC/3SC BK	6	On request
 Side element, black, 1-row, 4 connections CH20M45 S 3SC/P2SC BK	6	On request
 Side element, black, 2-row 8 connections CH20M45 S 2PSC/3SC BK	6	1137740000
 Side element, black, 2-row 8 connections CH20M45 S 3SC/2PSC BK	6	1137750000

Ordering data

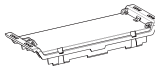
Type / Version	Qty.	Order No.
 Hinged cover, transparent CH20M45 C TP	30	1104440000
 Hinged cover, dark transparent CH20M45 C BK	30	1104430000
 Front element, closed, black CH20M45 FC BK	30	1164800000
 Front element, black CH20M45 F BK	30	1104420000

Female plug

Type / Version	Qty.	Order No.
Release lever, orange BHZ 5.00/04/90LH BK/DR	150	1063280000
Release lever, black BHZ 5.00/04/90LH BK/BK	150	1069350000
Release lever, blue BHZ 5.00/04/90LH BK/BL	150	1069380000

Male header

Type / Version	Qty.	Order No.
Left version, box packaging SHL-SMT 5.00/04GL 1.5BX	120	1063220000
SHL-SMT 5.00/04GL 4.2BX	120	1069640000
SHL-SMT 5.00/04GL 5.9BX	120	1069770000
Right version, box packaging SHL-SMT 5.00/04GR 1.5BX	120	1063150000
SHL-SMT 5.00/04GR 4.2BX	120	1069570000
SHL-SMT 5.00/04GR 5.9BX	120	1069710000
Left version, tape-on-reel SHL-SMT 5.00/04GL 1.5RL	130	1063250000
SHL-SMT 5.00/04GL 4.2RL	130	1069670000
SHL-SMT 5.00/04GL 5.9RL	130	1069810000
Right version, tape-on-reel SHL-SMT 5.00/04GR 1.5RL	130	1063180000
SHL-SMT 5.00/04GR 4.2RL	130	1069610000
SHL-SMT 5.00/04GR 5.9RL	130	1069740000

Plug cover

Type / Version	Qty.	Order No.
Cover, black 4-pole CH20M AD SHL 5.00/04 BK	50	1221310000

Markers

Type / Version	Qty.	Order No.
Device marker hinged cover ESG 8/13.5/43.3 SAI AU	5	1912130000
Device marker Female plug ESG 6.6/20 BHZ 5.00/04	200	1082540000

CH20M67



Modular component housing for electronic components

- 67.5 mm wide
- Pluggable wire connection
- Max. 72 wires

Technical data

Insulating material	PA6.6
Flammability rating (UL94)	V0
Rated voltage	250 V AC
Rated current	10 A

Demo Kit

Type / Version	Qty.	Order No.
SK DEMO CH20M67	1	On request

Dimensional drawing

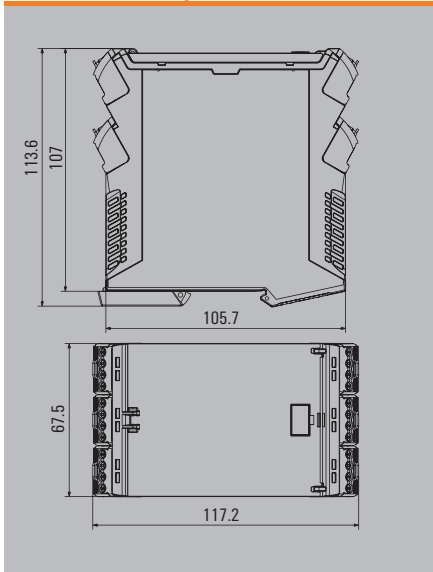

CH20M67 B

BASE element

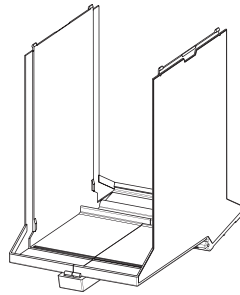

BASE



Base element with pre-attached snap-on foot

- Optionally with BUS cut-out
- Optional with cut-out for functional earth (FE)

Ordering data

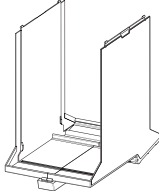
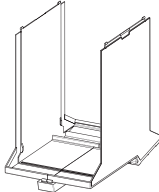
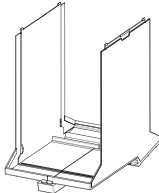
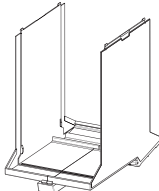
Type / Version	Qty.	Order No.
 Base element, black, Snap-on foot, black CH20M67 B BK/BK	4	1235270000
 Base element, black, Snap-on foot, orange CH20M67 B BK/O	4	1235250000
 Base element, black, BUS, Snap-on foot, orange CH20M67 B BUS BK/OR	4	1247240000
 Base element, black, FE, Snap-on foot, orange CH20M45 B FE BK/OR	4	1247250000

CH20M67 S

SIDE element

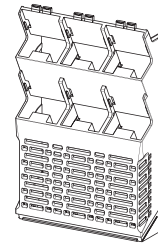

SIDE



Side element

- Symmetrical versions

Ordering data

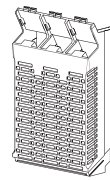
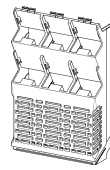
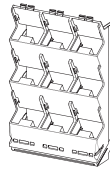
Type / Version	Qty.	Order No.
 Side element, black, 1-row, 12 connections CH20M67 S P2SC/P2SC/P2SC BK	4	On request
 Side element, black, 2-row, 24 connections CH20M67 S 2PSC/2PSC/2PSC BK	4	1235320000
 Side element, black, 3-row, 36 connections CH20M67 S 3P/3P/3P BK	4	On request

CH20M67 F

FRONT element

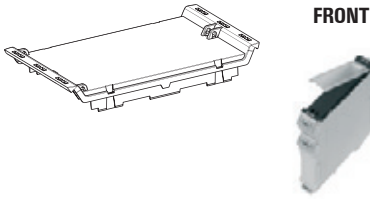

Front element

CH20M67 C

COVER element

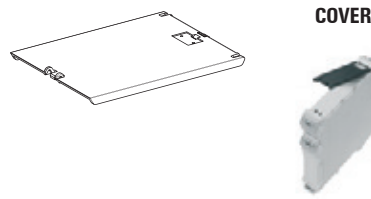

Hinged cover

Connection system

and accessories

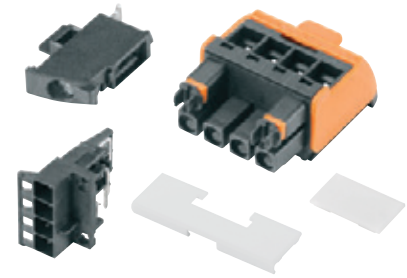

Female plug 4-pole, black
Male header 4-pole, black
Left and right versions of header

Ordering data

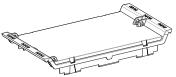
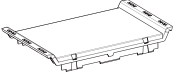
Type / Version	Qty.	Order No.
 Front element, black CH20M67 F BK	30	On request
 Front element, closed, black CH20M67 FC BK	30	1235310000

Ordering data

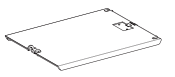
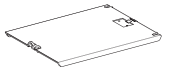
Type / Version	Qty.	Order No.
 Hinged cover, dark transparent CH20M67 C BK	30	On request
 Hinged cover, transparent CH20M67 C TP	30	On request

Female plug

Type / Version	Qty.	Order No.
Release lever, orange BHZ 5.00/04/90LH BK/DR	150	1063280000
Release lever, black BHZ 5.00/04/90LH BK/BK	150	1069350000
Release lever, blue BHZ 5.00/04/90LH BK/BL	150	1069380000

Male header

Type / Version	Qty.	Order No.
Left version, box packaging SHL-SMT 5.00/04GL 1.5BX	120	1063220000
SHL-SMT 5.00/04GL 4.2BX	120	1069640000
SHL-SMT 5.00/04GL 5.9BX	120	1069770000
Right version, box packaging SHL-SMT 5.00/04GR 1.5BX	120	1063150000
SHL-SMT 5.00/04GR 4.2BX	120	1069570000
SHL-SMT 5.00/04GR 5.9BX	120	1069710000
Left version, tape-on-reel SHL-SMT 5.00/04GL 1.5RL	130	1063250000
SHL-SMT 5.00/04GL 4.2RL	130	1069670000
SHL-SMT 5.00/04GL 5.9RL	130	1069810000
Right version, tape-on-reel SHL-SMT 5.00/04GR 1.5RL	130	1063180000
SHL-SMT 5.00/04GR 4.2RL	130	1069610000
SHL-SMT 5.00/04GR 5.9RL	130	1069740000

Plug cover

Type / Version	Qty.	Order No.
Cover, black 4-pole CH20M AD SHL 5.00/04 BK	50	1221310000

Markers

Type / Version	Qty.	Order No.
Device marker hinged cover ESG 8/13.5/43.3 SAI AU	5	1912130000
Device marker Female plug ESG 6.6/20 BHZ 5.00/04	200	1082540000

LHZ

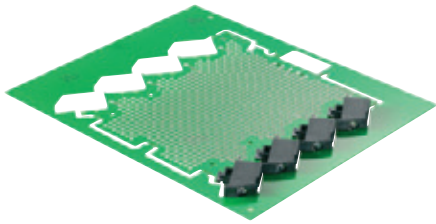

THR PCB terminal for 6 mm housings,
CH20M6 reflow-compatible,
Pole count: 1
solder pin length: 1.5 mm
Orientation: 90°

Technical data

Insulating material	LCP
Flammability rating (UL94)	V0
Rated voltage	250 V
Rated current	13 A

Conductors that can be connected

Clamping range	0.13 mm ² - 2.5 mm ²
Wire cross-section, AWG, min.	AWG 26 - AWG 14
Solid, min. H05(07) V-U	0.2 mm ² - 2.5 mm ²
Flexible, min. H05(07) V-K	0.2 mm ² - 2.5 mm ²
With wire-end ferrule with DIN 46 228/4, min.	0.2 mm ² - 2.5 mm ²

Rated data according to DIN IEC

Rated voltage for surge voltage class / contamination degree III/3	250 V
Rated impulse voltage for surge voltage class / contamination degree III/3	4 kV
Rated voltage for surge voltage class / contamination degree III/2	320 V
Rated impulse voltage for surge voltage class / contamination degree III/2	4 kV
Rated voltage for surge voltage class / contamination degree II/2	500 V
Rated impulse voltage for surge voltage class / contamination degree II/2	4 kV

Dimensional drawing

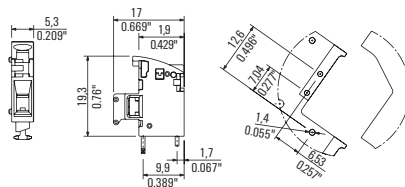

Version left

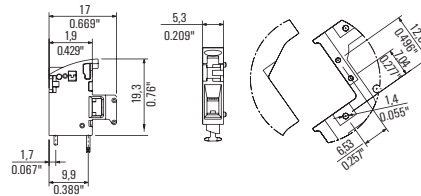

Version right

LHZ



Ordering data

Type / Version	Qty.	Order No.
LHZ-SMT L 1.5SN BK RL Left version, tape-on-reel	432	2418580000
LHZ-SMT R 1.5SN BK RL Right version, tape-on-reel	432	2418590000

Derating curve

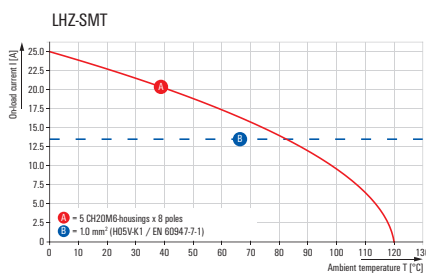

Note: Rated data according to UL - refer to the online data sheet

Circuit board positions in CH20M

Circuit board positions in CH20M				
Housing width (mm)	12.5	22.5	45	67.5
Number of circuit boards	1	1	2	3
Positions per circuit board	1	2	4	4



Dimensional sketch

PCB-Positions are determined through the configuration of the pin-headers (also see SHL-SMT)

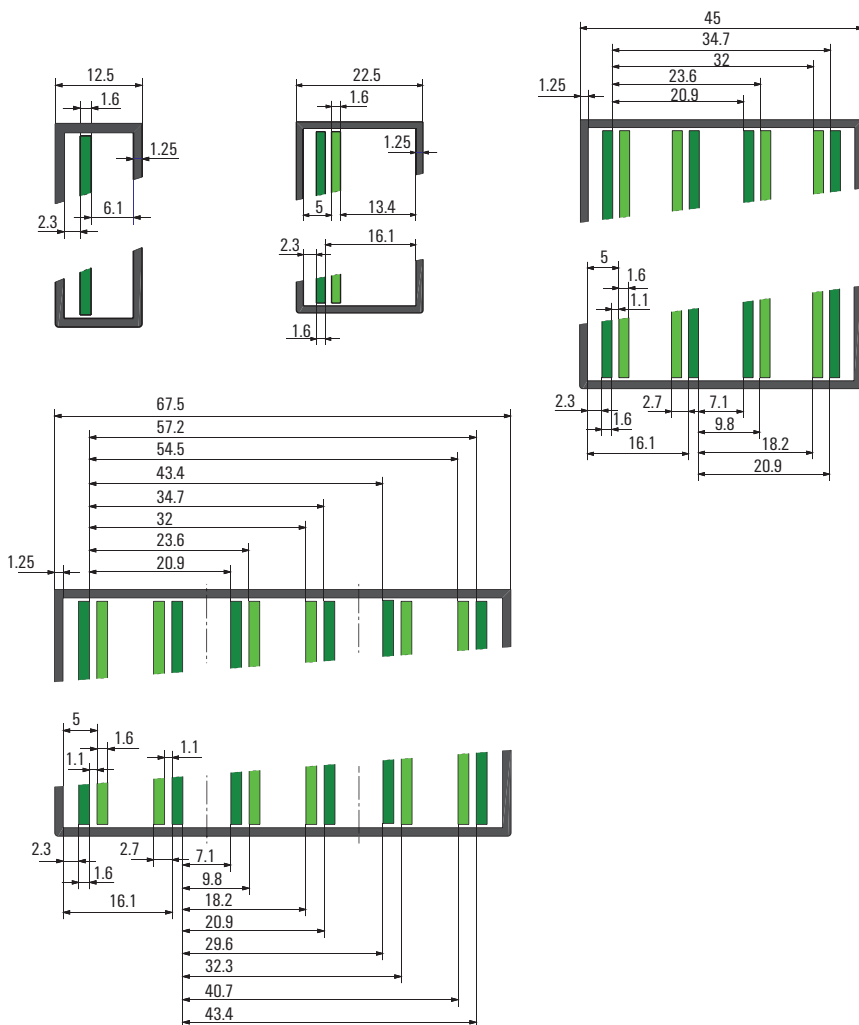

Features of the BHZ/SHL connector system

- Clamping yoke screw connection – with WIRE READY, wire guard protection and plus/minus screw
- Integrated, captive coding (with „AutoSet“ function) protects against accidental mismatch
- Colored ejection lever
- Leading contact on the male headers
- Finger-safety provided for both, male and female connector
- Labeling option with printable marker pads

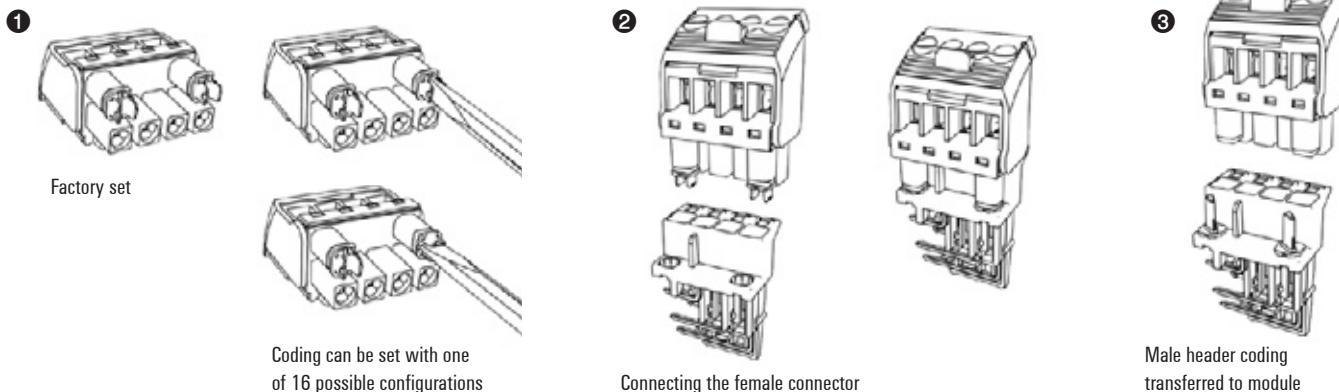

SHL-SMT

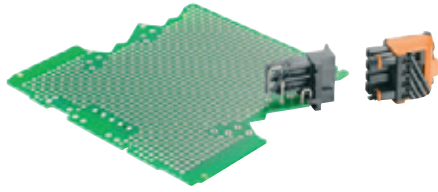

THR male header for modular housing CH20M12-67
 Can be reflow soldered, resistant to high temperatures
 The position of the PCB (see also dimensional sketch) is determined through the configuration of the pin headers
 Suffix 1.5: PCB position 5,0 mm / pin length 1,5 mm (Reflow)
 Suffix 4.2: PCB position 2,3 mm / pin length 1,5 mm (Reflow)
 Suffix 5.9: PCB position 2,3 mm / pin length 3,2 mm (Wave)

Technical data

Insulating material	LCP
Flammability rating (UL94)	VO
Rated voltage	250 V
Rated current	10 A

SHL-SMT 5.00/GL BX



Left-sided pin header
 Box packaging

Ordering data

Type / Version	Poles	Qty.	Order No.
SHL-SMT 5.00/02GL 4.2BX	2	156	1069620000
SHL-SMT 5.00/02GL 5.9BX	2	156	1069750000
SHL-SMT 5.00/03GL 1.5BX	3	120	1063210000
SHL-SMT 5.00/03GL 4.2BX	3	120	1069630000
SHL-SMT 5.00/03GL 5.9BX	3	120	1069760000
SHL-SMT 5.00/04GL 1.5BX	4	120	1063220000
SHL-SMT 5.00/04GL 4.2BX	4	120	1069640000
SHL-SMT 5.00/04GL 5.9BX	4	120	1069770000

Dimensional drawing

Version left
 2-pole

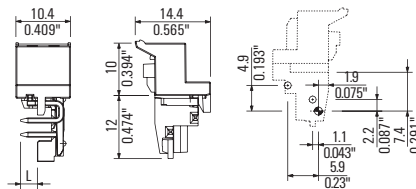

3-pole

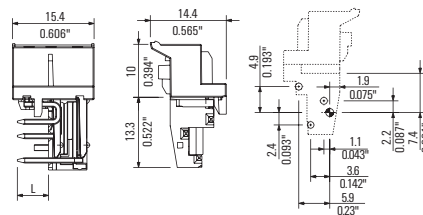

SHL-SMT 5.00GL RL



Left-sided pin header
 Tape-on-reel

Ordering data

Type / Version	Poles	Qty.	Order No.
SHL-SMT 5.00/02GL 4.2RL	2	260	1069650000
SHL-SMT 5.00/02GL 5.9RL	2	260	1069780000
SHL-SMT 5.00/03GL 1.5RL	3	175	1063240000
SHL-SMT 5.00/03GL 4.2RL	3	175	1069660000
SHL-SMT 5.00/03GL 5.9RL	3	175	1069790000
SHL-SMT 5.00/04GL 1.5RL	4	130	1063250000
SHL-SMT 5.00/04GL 4.2RL	4	130	1069670000
SHL-SMT 5.00/04GL 5.9RL	4	130	1069810000

Dimensional drawing

Version right
 2-pole

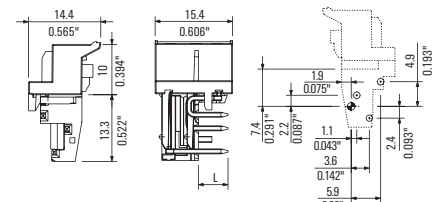

3-pole

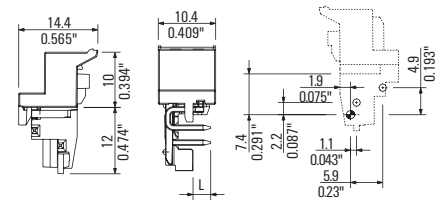

Rated data when used together with BHZxx female plug; refer to page I.32

SHL-SMT 5.00/GR BX



Version right
Box packaging

SHL-SMT 5.00GR RL



Version right
Tape-on-reel

Ordering data

Type / Version	Poles	Qty.	Order No.
SHL-SMT 5.00/02GR 4.2BX	2	156	1069550000
SHL-SMT 5.00/02GR 5.9BX	2	156	1069680000
SHL-SMT 5.00/03GR 1.5BX	3	120	1063140000
SHL-SMT 5.00/03GR 4.2BX	3	120	1069560000
SHL-SMT 5.00/03GR 5.9BX	3	120	1069690000
SHL-SMT 5.00/04GR 1.5BX	4	120	1063150000
SHL-SMT 5.00/04GR 4.2BX	4	120	1069570000
SHL-SMT 5.00/04GR 5.9BX	4	120	1069710000

Dimensional drawing

Version left
4-pole

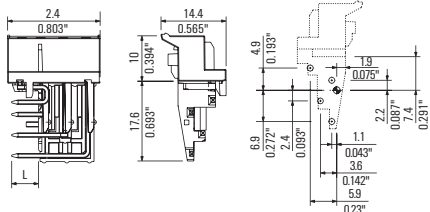

Ordering data

Type / Version	Poles	Qty.	Order No.
SHL-SMT 5.00/02GR 4.2RL	2	260	1069580000
SHL-SMT 5.00/02GR 5.9RL	2	260	1069720000
SHL-SMT 5.00/03GR 1.5RL	3	175	1063170000
SHL-SMT 5.00/03GR 4.2RL	3	175	1069590000
SHL-SMT 5.00/03GR 5.9RL	3	175	1069730000
SHL-SMT 5.00/04GR 1.5RL	4	130	1063180000
SHL-SMT 5.00/04GR 4.2RL	4	130	1069610000
SHL-SMT 5.00/04GR 5.9RL	4	130	1069740000

Dimensional drawing

Version right
4-pole

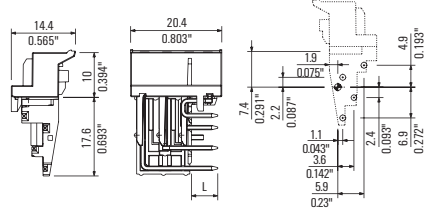

BHZ

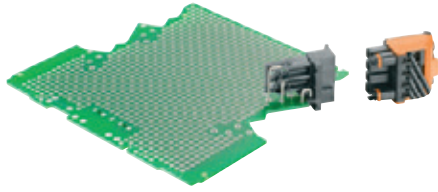

Female plug for modular housing CH20M12-67
5.00 mm, clamping-yoke connection, integrated
coding, release lever can be colour coded

Technical data

Insulating material	PA
Flammability rating (UL94)	V0
Rated voltage	250 V
Rated current	10 A

Conductors that can be connected

Clamping range	0.13 mm ² - 3.31 mm ²
Wire cross-section, AWG, min	AWG 26 - AWG 14
Solid, min. H05(07) V-U	0.2 mm ² - 2.5 mm ²
Flexible, min. H05(07) V-K	0.2 mm ² - 2.5 mm ²
With wire end ferrule, acc. to DIN 46 228/1, max.	0.2 mm ² - 2.5 mm ²
With wire-end ferrule with DIN 46 228/4, min.	0.2 mm ² - 2.5 mm ²

Rated data according to DIN IEC

Rated current, Max. pole count (Tu=20 °C)	10 A
Rated current, Max. pole count (Tu=40 °C)	9 A
Rated voltage for surge voltage class / contamination degree III/3	250 V
Rated impulse voltage for surge voltage class / contamination degree III/3	4 kV
Rated impulse voltage for surge voltage class / contamination degree III/2	4 kV
Rated voltage for surge voltage class / contamination degree III/2	320 V
Rated voltage for surge voltage class / contamination degree II/2	400 V
Rated impulse voltage for surge voltage class / contamination degree II/2	4 kV

Note: Rated data according to UL - refer to the online data sheet

Dimensional drawing

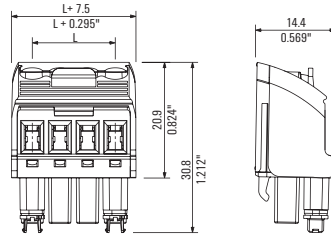

BHZ 5.00/90 BK/OR



Release lever, orange

Ordering data

Type / Version	Poles	Qty.	Order No.
BHZ 5.00/02/90LH BK/OR	2	150	1063260000
BHZ 5.00/03/90LH BK/OR	3	180	1063270000
BHZ 5.00/04/90LH BK/OR	4	78	1063280000

Derating curve

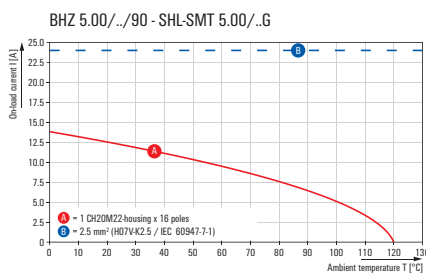
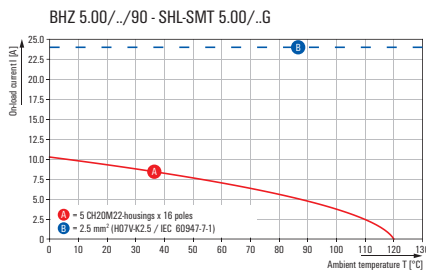

BHZ 5.00/90 BK/BK



Release lever, black

BHZ 5.00/90 BK/BL



Release lever, blue

Accessories

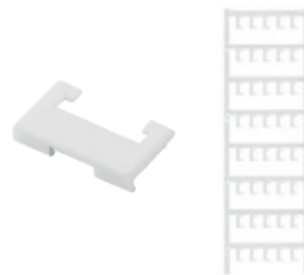

Marker for release lever

Ordering data

Type / Version	Poles	Qty.	Order No.
BHZ 5.00/02/90LH BK/BK	2	150	1069330000
BHZ 5.00/03/90LH BK/BK	3	108	1069340000
BHZ 5.00/04/90LH BK/BK	4	78	1069350000

Ordering data

Type / Version	Poles	Qty.	Order No.
BHZ 5.00/02/90LH BK/BL	2	150	1069360000
BHZ 5.00/03/90LH BK/BL	3	108	1069370000
BHZ 5.00/04/90LH BK/BL	4	78	1069380000

Ordering data

Type / Version	Poles	Qty.	Order No.
ESG 6.6/11 BHZ 5.00/02	2	200	1082490000
ESG 6.6/15 BHZ 5.00/03	3	200	1082520000
ESG 6.6/20 BHZ 5.00/04	4	200	1082540000



SR-SMD

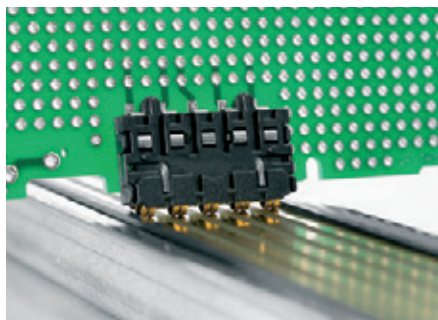

Bus contact block
Reflow-compatible, resistant to high temperatures,
5-pole, for rail bus

Technical data

Insulating material	LCP
Flammability rating (UL94)	V0
Rated voltage	63 V AC
Rated current	2 A

Dimensional drawing

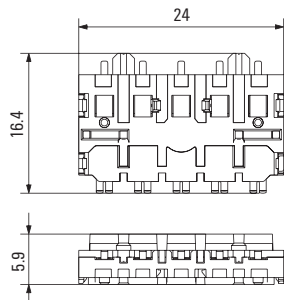

For CH20M6

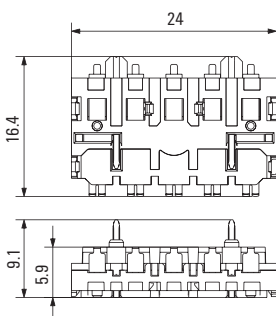

With centre solder flange for CH20M12-67

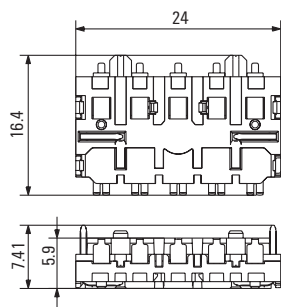

With solder flange for CH20M12-67

SR-SMD

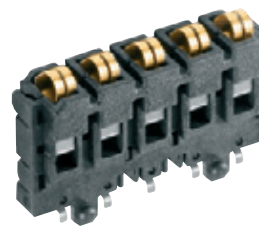

Bus contact for CH20M6

Ordering data

Type / Version	Qty.	Order No.
SR-SMD 4.50/05/90 AU BK BX	72	1155840000

Note: Rated data according to UL - refer to the online data sheet

SR-SMD

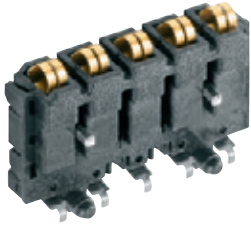

Bus contact with centre solder flange
for CH20M12-67

SR-SMD

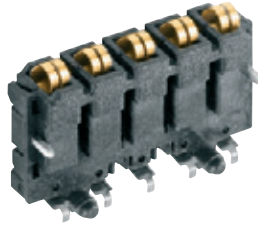

Bus contact with solder flange
for CH20M12-67

Accessories, bus connection



Ordering data

Type / Version	Qty.	Order No.
SR-SMD 4.50/05/90LFM AU BK BX	72	1155870000

Ordering data

Type / Version	Qty.	Order No.
SR-SMD 4.50/05/90LF AU BK BX	72	1155890000

Bus PCB

Type / Version	Qty.	Order No.
CH20M BUS 4.50/05 AU/250	10	1248220000
CH20M BUS 4.50/05 AU/500	10	1248230000
CH20M BUS 4.50/05 AU/750	5	1248240000

Support section, bus circuit board

Type / Version	Qty.	Order No.
CH20M BUS-PROFIL TS 35X15/250	10	1248180000
CH20M BUS-PROFIL TS 35X15/500	10	1248190000
CH20M BUS-PROFIL TS 35X15/750	5	1248210000
CH20M BUS-PROFIL TS 35X7.5/250	5	1248150000
CH20M BUS-PROFIL TS 35X7.5/500	5	1248160000
CH20M BUS-PROFIL TS 35X7.5/750	5	1248170000

Note: length specification /XXX = 250, 500 or 750 mm

Hoods and end plates

Type / Version	Qty.	Order No.
CH20M BUS-ADP TS 35/250	10	1248250000
CH20M BUS-ADP TS 35/500	10	1248260000
CH20M BUS-ADP TS 35/750	5	1248270000
CH20M BUS-AP LI TS 35X7.5 & 15	50	1193160000
CH20M BUS-AP RE TS 35X7.5 & 15	50	1193170000

Mounting rail

Type / Version	Qty.	Order No.
TS 35X7.5/LL 1M/ST/ZN	10	0514510000
TS 35X15/LL 1M/ST/ZN	10	0236510000

Note: ADP = cover profile
AP = end plate

OMNIMATE Housing MICROBOX / TERMINALBOX

The MICROBOX and TERMINALBOX series of small housings are the perfect solution for miniature sliced applications or for the protective circuitry used in connection with terminal blocks.

Up to 6 wires can be connected using the integrated (but high-performance) clamping-yoke screw or tension-clamp wire connection mechanisms.

Because of its closed construction, each individual MICROBOX is finger-safe. The TERMINALBOX can be aligned side-by-side without end or closed off using an end plate.

Pluggable cross-connectors from our terminal block line allow simple, safe power distribution of up to 32 A.

Secure contacts

The TERMINALBOX MCZ 1.5 can optionally be equipped with a contact element that automatically establishes contact with the rail when the housing is snapped on.

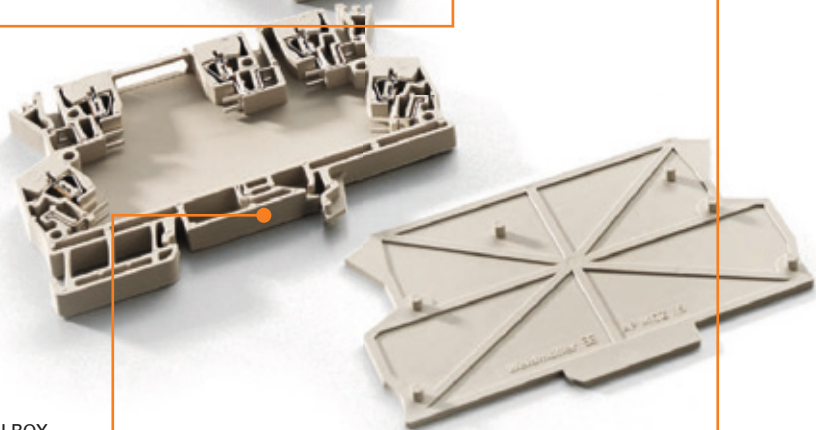
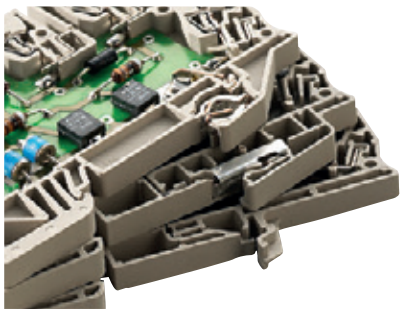
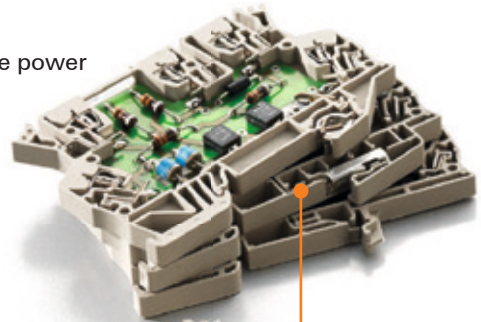

Compact integration

With a width of only 6.00 mm, the TERMINALBOX MCZ 1.5 provides enough space for a miniature circuit board and 5 tension clamp connection for wires up to 1.5 mm².

Seamlessly connected

High-power cross-connectors allow power (up to 32 A) to be easily and quickly distributed on up to three levels.

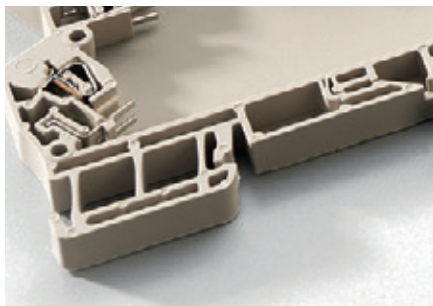

Easy to operate

The transparent hinged covers make adjustments simple (for example, using DIP switches). Labelling is also possible.

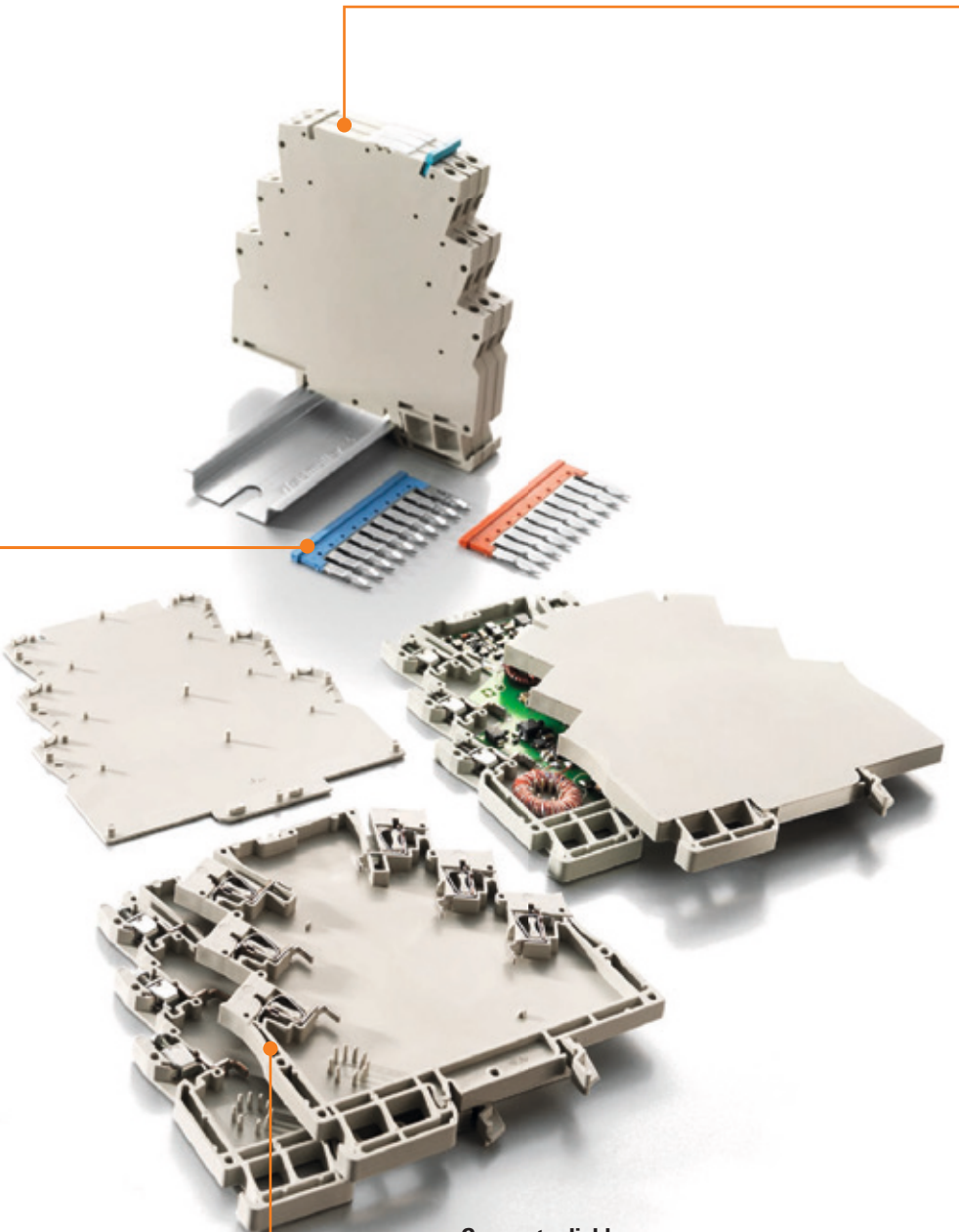

Connect reliably

The MICROBOX provides a permanent, secure clamp connection for 6 wires up to 2.5 mm² (MHS 6 with clamping yoke screw connection) or up to 1.5 mm² (MHZ 6 with tension-clamp spring connection).

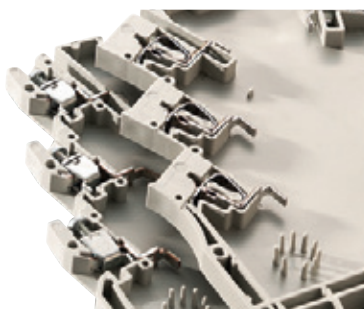

MICROBOX MHS 6

Miniature sliced-section housing in 6.1 mm width A total of 6 clamping yoke screw connections (for 2.5 mm² wires) can be manually or selectively wave soldered.



MICROBOX MHZ 6

Miniature sliced-section housing in 6.1 mm width A total of 6 tension clamp connection (for 1.5 mm² wires) can be manually or selectively wave soldered.



TERMINALBOX MCZ 1.5

Terminal-block-format open housings with tension clamp connection for wires up to 1.5 mm². A total of 5 connection elements can be manually or selectively wave soldered.

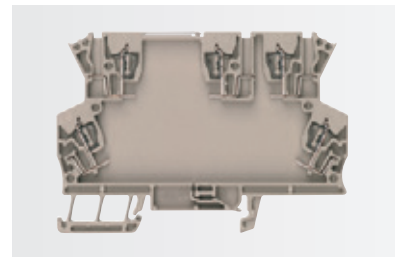

MCZ 1.5

The transparent hinged top plate is used for labelling and calibration. Maximum equipment level requires 2 short and 3 long current bars. The space available and the number of connections can be doubled using the frame. CAD drawings that ease the production of layouts and equipping of boards (details of blocked area, max. component heights, pads, etc.), are available on request. The MCZ housing kit consists of:

- 1 terminal holder
- 1 top plate
- 1-5 current bars with tension clamp
- 1 end plate (if required)

Technical data

General data	
Dimensions W x L x H (w. TS35 x 7.5)	mm
No. of connections	total
Access for calibration	
Shielding	
Contact to the mounting rail	
Number of PCB per module	
PCB-connection	
Thickness of PCB	
Ingress protection class	
Tightening torque range	
Stripping length	
Pollution severity	
Material	
Flammability class UL 94	
Colour of insulating material	
Clampable conductors (H05V/H07V)	
Solid	mm ²
Flexible	mm ²
Max. conductor AWG	
Plug gauge to 60947-1	
Note	

Ordering data

Individual parts	
For mounting rail TS35	with connection element for connection element for mounting rail contact, for connection element
For mounting rail TS32	with connection element
Frame for TS35	
Frame for TS35	for connection element
Frame for TS32	
Top part	open closed
Current bars (w. tension clamp)	short version long version
Current bars	horizontal vertical
Clamp, yoke unit	clamp, yoke + screw
Screw	
Clamping yoke	
Mounting rail contact	
Housing cover	
Note	

Accessories

End plate	
Cross-connection	
Note	

MCZ 1.5

Tension clamp connection

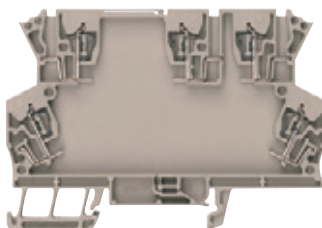

6 / 91.3 / 63.5	
5	
Movable top plate	
not available	
Earthing-contact	
1	
soldered connection, directly	
1.0 (+ 0.2) mm	
IP 20	
6 mm	
3	
PA	
VO	
beige/black	
Screw connection	Tension clamp connection
	0.2...1.5
	0.2...1.5
	AWG 26...AWG 16
Note	

Type	Qty.	Order No.
MCZ 5	10	8857560000
GH MCZ1.5	1	2224220000
GH MCZUE1.5/UE	1	2312290000
RA MCZ1.5	25	2224240000
KOPL MCZ1.5	18	2224040000
SMSE KU FE MCZ 1.5	1	2224390000
SMSE LN FE MCZ 1.5	1	2224380000
SMSE FE MCZ 1.5/PE	100	1003280000
Note		

Type	Qty.	Order No.
AP MCZ1.5	50	8389030000
ZQV 4N/2 RT	60	1793950000
ZQV 4N/2 BL	60	1793960000
ZQV 4N/2 GE	60	1758250000
Note		
Full housing available as set on request.		

OMNIMATE Housing RS

Profile housing

Flexible – more flexible – Profilform

Build housing in profile form – the flexible modular system of coloured and transparent PVC profiles and carrier modules the perfect combination of any mounting utilising standard pitches and precisely cut to length, this creates the perfect balance between flexibility and efficiency: The modular approach is ideal for assemblies with high space requirements and is particularly suited for small quantities or variable widths.

Flexible covers

See-through covers in various heights protect assemblies even with high components safely.

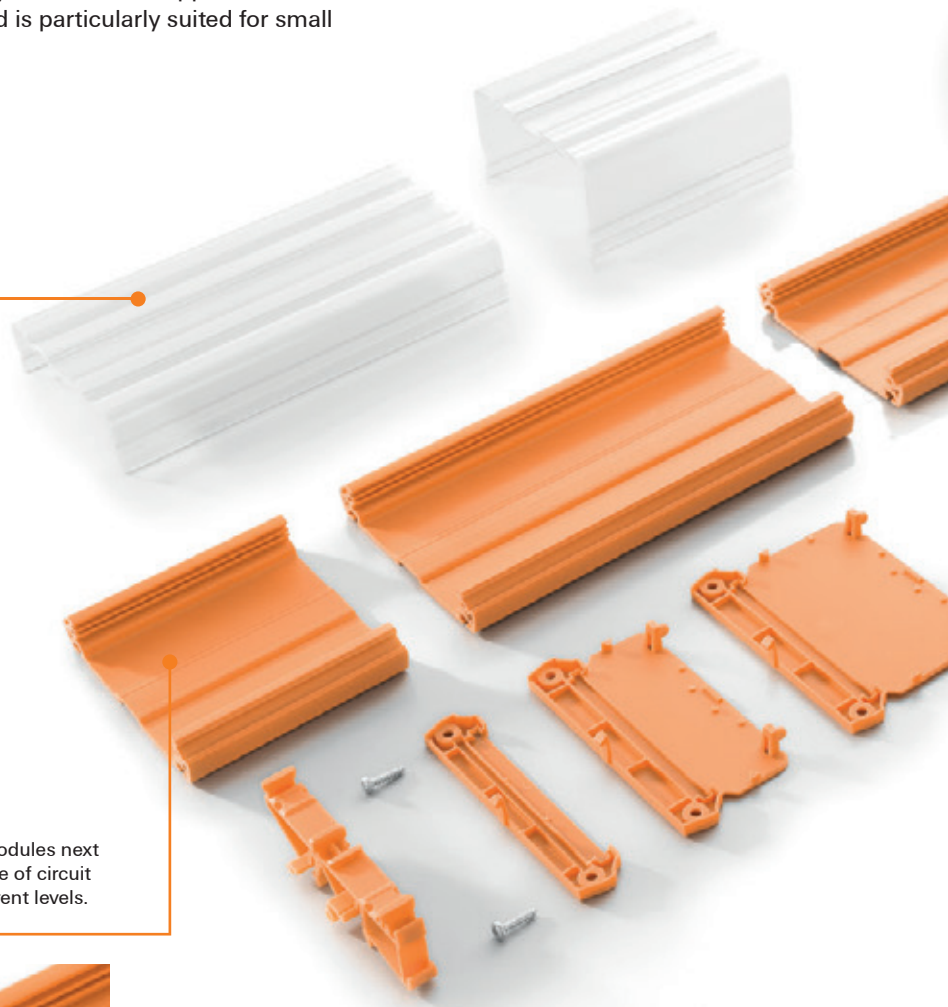

Flexible installation

Extruded profiles can take several modules next to each other. Depending on the type of circuit boards can be installed on two different levels.



Flexible lengths

Cut, or joined together in a row: extruded profiles can be easily adjusted to the space requirements of every application.

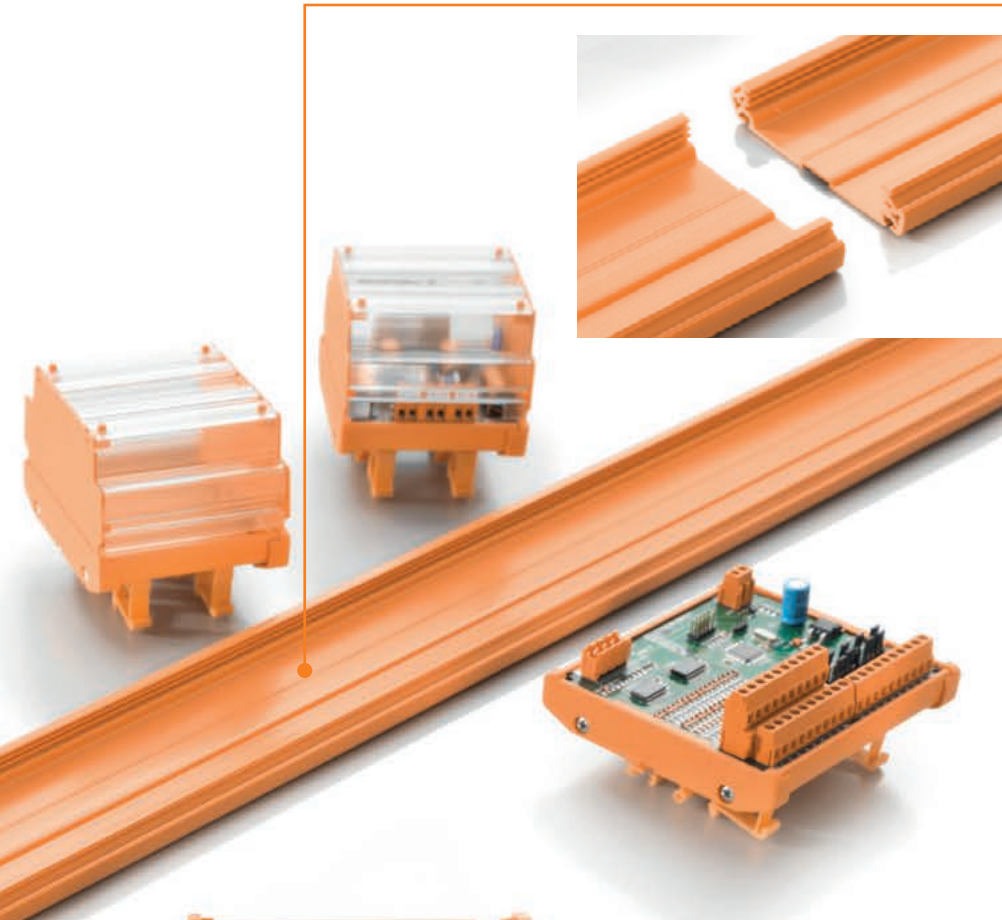

Variable RS-profile housing

Variable, precision cut extruded profile with different height cover hoods allow maximum packing density even for large electronic sub-assemblies.

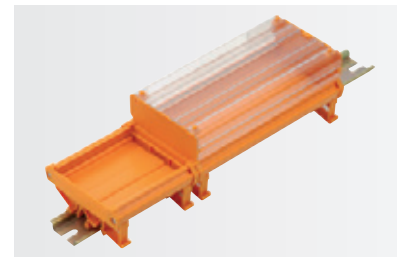

Modular RS-profile housing

Tool-free latching profiles with standard widths from 5 to 45 mm allow rapid assembly of tailor made solutions.



Flexible mounting

Mounting options: snapped onto the mounting rail or directly secured using screws.



OMNIMATE Housing RS

Profile housing







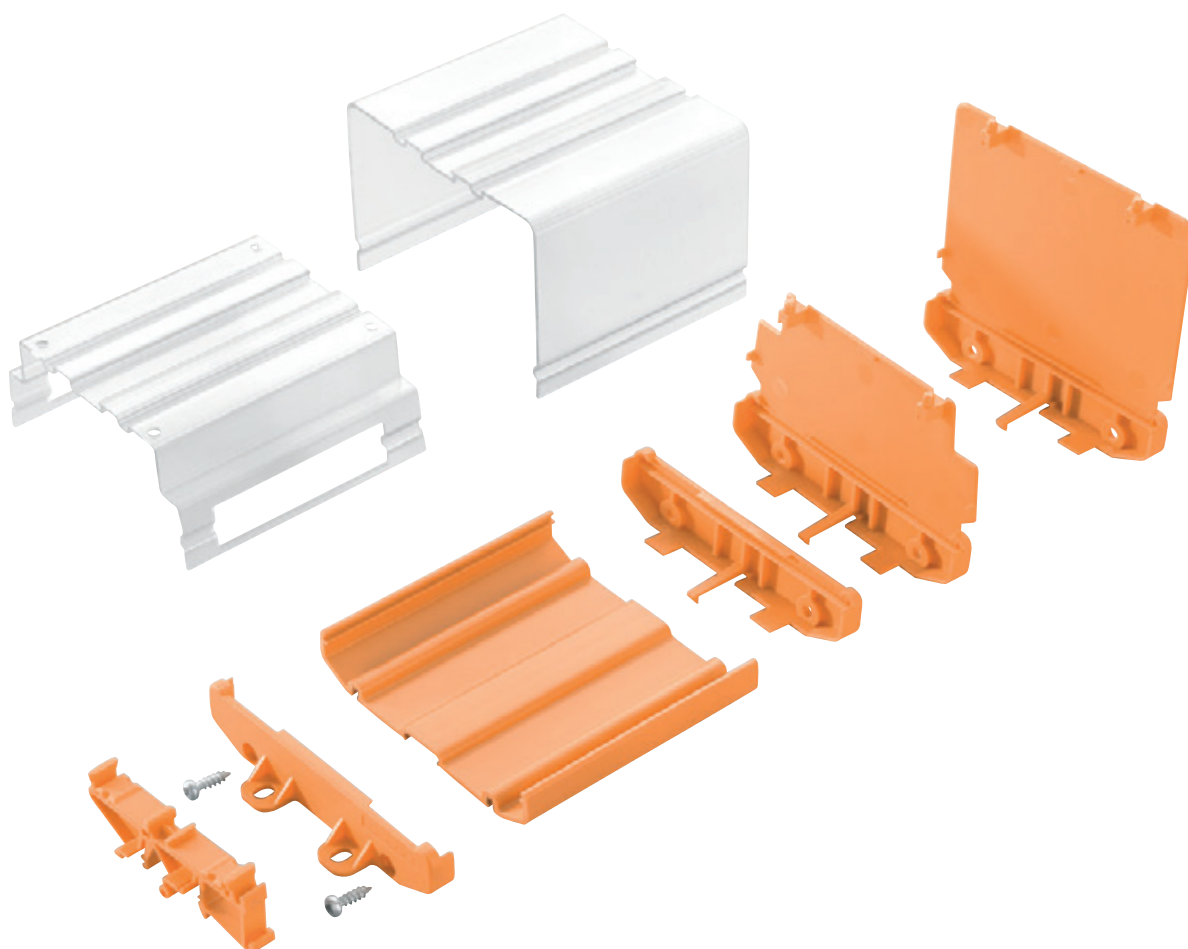



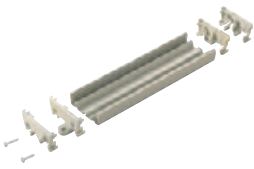





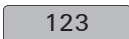

RS profile housings can be snapped on to DIN rails or mounted directly. They are available in six widths. The extruded profiles can be cut to length or joined together in modules and are ideal for low volume, special assemblies or test set-ups. Fitted transparent hoods are used to protect the components.

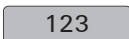
Width	Type	Construction/Width of circuit board	Catalogue pages	Colour
45 mm	RS45	Variable / 42 mm	I.44	■ Similar to RAL 9011
70 mm	RS70	Modular / 67.8 mm	I.45	■ Similar to RAL 7024
87 mm	RS80	Variable / 67.8 mm	I.46	■ Similar to RAL 2000
86 mm	RS90	Variable / 79.8 mm	I.47	
109 mm	RS100	Variable / 100 mm	I.48	
130.8 mm	RS122	Variable / 122 mm	I.49	

Note 1) Other colours on request

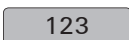

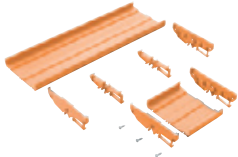
Housing variants

Housing variants	Description / Type	Design options
<p>RS 45</p> 	<p>RS extruded profile 45 mm variable</p> <p>Features:</p> <ul style="list-style-type: none"> • Width 45 mm • Circuit board width: 42 mm • Number of circuit boards (max.): 1 • Protection class (max.): IP 00 	  <ul style="list-style-type: none"> • Can be shortened to any length • Rail mounted • Direct mount ²⁾ • machinable
<p>RS 70</p> 	<p>RS extruded profile 70 mm modular</p> <p>Features:</p> <ul style="list-style-type: none"> • Width 70 mm • Circuit board width: 67.8 mm • Number of circuit boards (max.): 1 • Protection class (max.): IP 00 	 <ul style="list-style-type: none"> • Can be aligned side-by-side without any tools • Rail mounted
<p>RS 80</p> 	<p>RS extruded profile 80 mm variable</p> <p>Features:</p> <ul style="list-style-type: none"> • Width 87 mm • Circuit board width: 67.8 mm • Number of circuit boards (max.): 1 • Protection class (max.): IP 20 • Markable 	   <ul style="list-style-type: none"> • Can be shortened to any length • Rail mounted • Direct mount ²⁾ • Transparent hood (opt.) • machinable
<p>RS 90</p> 	<p>RS extruded profile 90 mm variable</p> <p>Features:</p> <ul style="list-style-type: none"> • Width 86 mm • Circuit board width: 79.8 mm • Number of circuit boards (max.): 1 • Protection class (max.): IP 00 	   <ul style="list-style-type: none"> • Can be shortened to any length • Rail mounted • Direct mount ²⁾ • machinable
<p>RS 100</p> 	<p>RS extruded profile 100 mm variable</p> <p>Features:</p> <ul style="list-style-type: none"> • Width 109 mm • Circuit board width: 100 mm • Number of circuit boards (max.): 1 • Protection class (max.): IP 20 	   <ul style="list-style-type: none"> • Can be shortened to any length • Rail mounted • Direct mount ²⁾ • Transparent hood (opt.) • machinable
<p>RS 122</p> 	<p>RS extruded profile 122 mm variable</p> <p>Features:</p> <ul style="list-style-type: none"> • Width 130.8 mm • Circuit board width: 122 mm • Number of circuit boards (max.): 2 • Protection class (max.): IP 00 	  <ul style="list-style-type: none"> • Can be shortened to any length • Rail mounted • machinable

 pad printing,
  markable,
  can be machine-worked (drilling/milling),
 ²⁾ Screw mount

RS 45

Depending on the end plate design, the profiles can be mounted directly or on rail

1. The rail-mountable assembly requires:

- 2 end plates for DIN-rail mounting
- 1 extruded profile
- 4 screws

2. Direct-mountable assembly requires:

- 2 end plates for direct mounting
- 1 extruded profile
- 4 screws

Description

B3 heights are available for cover profile and end plates:

TS-mounting:

TS32 = 45 mm, TS35x7.5 = 40.5 mm

Direct mounting: 24 mm

Dimensions of PCB

Thickness: 1.6 (±0.2) mm, width:

42 (+0.5) mm

Size of RS segment = PCB length - 4.5 mm

Size of ADP segment = PCB length - 1 mm

Example:

PCB length 160 mm,

RS = 155.5 mm, ADP = 159 mm

Dimensioned drawing

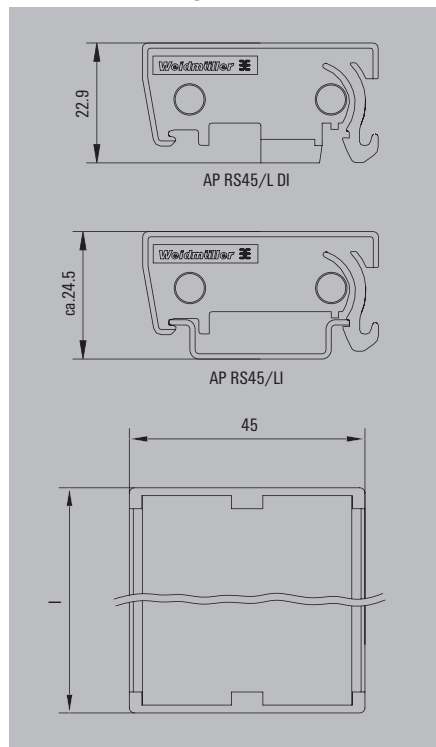

RS 45

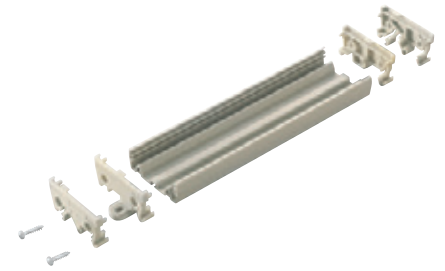

Technical data

General data	
Number of PCB per module	1
Thickness of PCB	1.6 (± 0.2) mm
Material	PVC/PA
Flammability class UL 94	V2
Colour of insulating material	beige
Note	

Ordering data

Extruded profile	
2000 mm	orange
2000 mm	grey
1000 mm	grey
155 mm	orange
Intermediate piece	
5 mm	
15 mm	
25 mm	
30 mm	
45 mm	
End plate w. locking foot	
Without cover	grey, left version
	grey, right-hand version
	orange, left version
	orange, right-hand version

Locking foot	
	orange
	grey
With marking facilities	left version
	right version
Without marking facilities	left version
	right version
Central	Intermediate foot

End plate for direct mounting	
Without cover	grey, left version
	grey, right version
	orange
	grey
For medium-high cover profile	orange
	grey
For high cover profile	orange
	grey
End plate for mounting rail installation	
Without cover	orange
	grey
For medium-high cover profile	orange
	grey
For high cover profile	orange
	grey

Cover profile 1000 mm	Medium-high
	high
Screws	

Note

1
1.6 (± 0.2) mm
PVC/PA
V2
beige

Type	Qty.	Order No.
RF RS 45 OR 2000	VO 1	4340430000
PF RS 45 GR 2000	VO 1	4027750000
PF RS 45 GR 1000	VO 10	8140880000

AP 45/LI	V2 20	8143910000
AP 45/RE	V2 20	8143900000
AP 45/LI OR	V2 20	1011590000
AP 45/RE OR	V2 20	1011600000

AP 45/LI DI	V2 20	8140870000
AP 45/RE DI	V2 20	8140860000

ADP 1/HP1 1M	V2 1	0485200000
LKSC M2.9x13VZ	100	4011200000

Other lengths on request.

RS 70

Chassis Form:

Rail-mounted version

- 1 clip-on foot left
- 1 clip-on foot right
- 1 or more intermediate pieces
- 1 clip-on foot centre if required

Description

Height: TS32 = 33.5 mm, TS35x7.5 = 29 mm

Dimensions of PCB:

Thickness: 1.6 (± 0.2) mm

Length: 67.8 (- 0.2) mm

Width of intermediate piece = PCB width - 2x9mm (snap-on feet)

Example:

PCB width = 68 mm

Width of intermediate piece = 50 mm

Intermediate piece 2x ZW 25 RS or
ZW 45 RS + ZW 5 RS

Dimensioned drawing

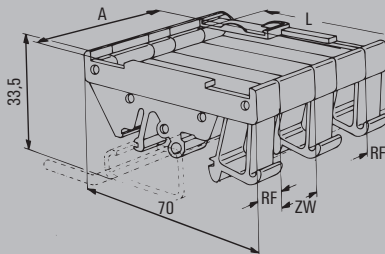

Technical data

General data

Number of PCB per module	1
Thickness of PCB	1.6 (± 0.2) mm
Material	PA
Flammability class UL 94	V2
Colour of insulating material	orange

Note

Ordering data

Extruded profile

2000 mm	orange
2000 mm	grey
1000 mm	grey
155 mm	orange

Intermediate piece

5 mm	
15 mm	
25 mm	
30 mm	
45 mm	

End plate w. locking foot

Without cover	grey, left version
	grey, right version

Locking foot

	orange
	grey
With marking facilities	left version
	right version
Without marking facilities	left version
	right version
Central	Intermediate foot

End plate for direct mounting

Without cover	grey, left version
	grey, right version
	orange
	grey
For medium-high cover profile	orange
	grey
For high cover profile	orange
	grey

End plate for mounting rail installation

Without cover	orange
	grey
For medium-high cover profile	orange
	grey
For high cover profile	orange
	grey

Cover profile	Medium-high
	high

Screws

Note

RS 70



Number of PCB per module	1
Thickness of PCB	1.6 (± 0.2) mm
Material	PA
Flammability class UL 94	V2
Colour of insulating material	orange

Type	Qty.	Order No.
ZW 5 RS OR	20	0119760000
ZW 15 RS OR	20	0119860000
ZW 25 RS OR	20	0126160000
ZW 30 RS OR	20	0119960000
ZW 45 RS OR	20	0120060000
RF RS 70 RE/A3/M.BEZ	20	0119560000
RF RS 70 LI/A2/O.SG	20	0119660000
RF RS 70 RE/A4/O.BEZ	20	0126260000
RF RS 70 MI/A6	20	0213760000

RS 80

Depending on the end plate design, the profiles can be mounted directly or on rail, and assembled with transparent cover profiles

1. The rail-mountable assembly requires:
- 2 end plates for DIN-rail mounting (with snap-on-foot integrated). The use of cover profiles requires different versions.
 - additional snap-on feet to support long profiles
 - 1 extruded profile
 - Optionally: 1 cover profile (2 different heights)
 - 4 screws

2. Direct-mountable assembly requires:

- 2 end plates for direct mounting
- 1 extruded profile
- Optionally: 1 cover profile (2 different heights)
- 4 screws

Description

3 heights are available for cover profile and end plates:

Rail mounting without cover:

TS32 = 45 mm, TS35x7.5 = 40.5 mm

Rail mounting with low cover:

TS32 = 72 mm, TS35x7.5 = 67.5 mm

Rail mounting with high cover:

TS32 = 91 mm, TS35x7.5 = 86.5 mm

Direct mounting without/low/high cover:

17 / 44 / 63 mm

Dimensions of PCB

Thickness: 1.6 (±0.2) mm, width:

67.8 (+0.2) mm

Size of RS segment = PCB length - 4.5 mm

Size of ADP segment = PCB length - 2 mm

Example:

PCB length 160 mm

RS = 155.5 mm, ADP = 158 mm

Dimensioned drawing

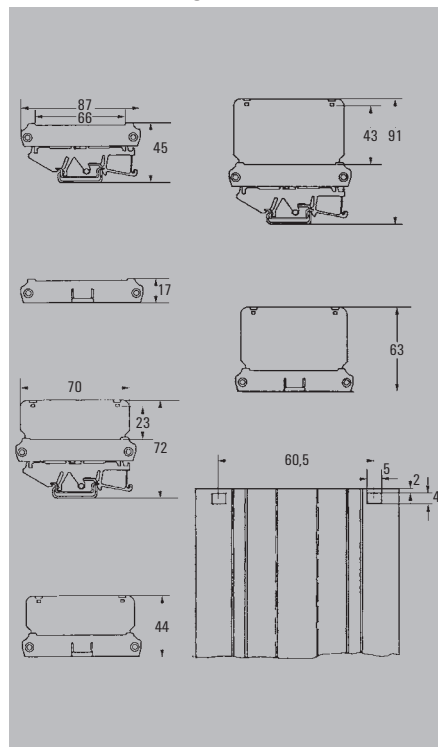

Technical data

General data

Number of PCB per module
Thickness of PCB
Material
Flammability class UL 94
Colour of insulating material

Note

Ordering data

Extruded profile	
2000 mm	orange
2000 mm	grey
1000 mm	grey
155 mm	orange

Intermediate piece

5 mm
15 mm
25 mm
30 mm
45 mm

End plate w. locking foot

Without cover	grey, left version
	grey, right version

Locking foot

With marking facilities	orange
	grey
Without marking facilities	left version
	right version
Central	left version
	right version
	intermediate foot

End plate for direct mounting

Without cover	grey, left version
	grey, right version
For medium-high cover profile	orange
	grey
For high cover profile	orange
	grey

End plate for mounting rail installation

Without cover	orange
	grey
For medium-high cover profile	orange
	grey
For high cover profile	orange
	grey

Cover profile	1000 mm	Medium-high
	1000 mm	high
Screws		

Note

RS 80



1
1.6 (± 0.2) mm
PVC/PA
VO
orange

Type	Qty.	Order No.
PF RS 80 OR 2000MM	VO 1	4157440000
PF RS 80 GR 2000MM	VO 1	4183130000

AP RF80 LI	V2 20	8156210000
AP RF80 RE	V2 20	8156200000
RF 180	20	1324460000
RF 180 GR	V2 20	1773400000

AP 80 D	V2 20	1324360000
AP 85 D	V2 20	1411060000
AP 86 D	V2 20	1411160000

AP 80	V2 20	1324260000
AP 80	V2 20	8320300000
AP 85	V2 20	1410860000
AP 86	20	1410960000

ADP 5	V2 1	4167150000
ADP 6	V2 1	4167160000
LKSC M2.9x13VZ	100	4011200000

Other lengths on request.

RS 90

The rail-mountable assembly requires:

- 2 end plates for DIN-rail mounting
- 1 extruded profile
- 4 screws

Description

Dimensions of PCB

Thickness: 1.6 (±0.2) mm, width: 79.8 (+0.2) mm

Size of RS segment = PCB length - 4.5 mm

Example:

PCB length 160 mm

RS = 155.5 mm

Dimensioned drawing

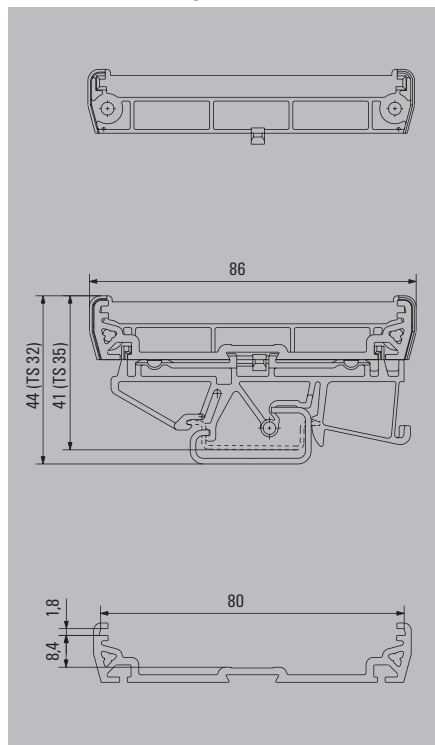

RS 90



Technical data

General data

Number of PCB per module	
Thickness of PCB	
Material	
Flammability class UL 94	
Colour of insulating material	

Note

Ordering data

Extruded profile	
2000 mm	orange
2000 mm	grey
1000 mm	
155 mm	orange

Intermediate piece

5 mm
15 mm
25 mm
30 mm
45 mm

End plate w. locking foot

Without cover	grey, left version
	grey, right version

Locking foot

	orange
	grey
With marking facilities	left version
	right version
Without marking facilities	left version
	right version
Central	intermediate foot

End plate for direct mounting

Without cover	grey, left version
	grey, right version
	orange
	grey
For medium-high cover profile	orange
	grey
For high cover profile	orange
	grey

End plate for mounting rail installation

Without cover	orange
	grey
For medium-high cover profile	orange
	grey
For high cover profile	orange
	grey

Cover profile	Medium-high
	high

Screws	
--------	--

Note

			1
		1.6 (± 0.2) mm	
		PVC/PA	
		VO	
		orange	

Type		Qty.	Order No.
PF RS 90 OR 2000MM	VO	1	4053240000
PF RS 90 GR 2000MM	VO	1	4051810000

RF 180	V2	20	1324460000
RF 180 GR	V2	20	1773400000

AP 90 OR	V2	20	1961880000
AP 90 GR	V2	20	1961890000

LKSC M2.9x13VZ		100	4011200000
----------------	--	-----	------------

Other lengths on request.

RS 100

Depending on the end plate design, the profiles can be mounted directly or on rail, and assembled with transparent cover profiles

- The rail-mountable assembly requires:
 - 2 end plates for DIN-rail mounting (with snap-on-foot integrated). The use of cover profiles requires different versions.
 - additional snap-on feet to support long profiles
 - 1 extruded profile
 - Optionally: 1 cover profile (2 different heights)
 - 4 screws
- Direct-mountable assembly requires:
 - 2 end plates for direct mounting
 - 1 extruded profile
 - Optionally: 1 cover profile (2 different heights)
 - 4 screws

Description

3 heights are available for cover profile and end plates:

Rail mounting without cover:

TS32 = 45 mm, TS35x7.5 = 40.5 mm

Rail mounting with low cover:

TS32 = 89 mm, TS35x7.5 = 84.5 mm

Rail mounting with high cover:

TS32 = 121 mm, TS35x7.5 = 116.5 mm

Direct mounting without/low/high cover:

24 / 69 / 99 mm

Dimensions of PCB

Thickness: 1.6 (±0.2) mm, width:

100 (+0.5) mm

Size of RS segment = PCB length - 4.5 mm

Size of ADP segment = PCB length - 1 mm

Example:

PCB length 160 mm

RS = 155.5 mm, ADP = 159 mm

Dimensioned drawing

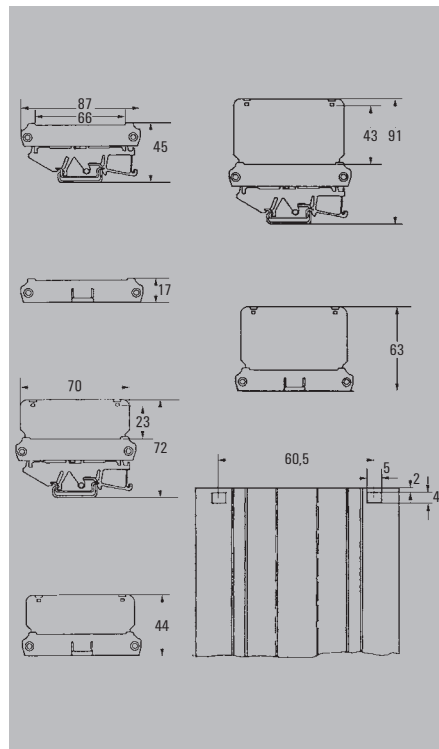

RS 100

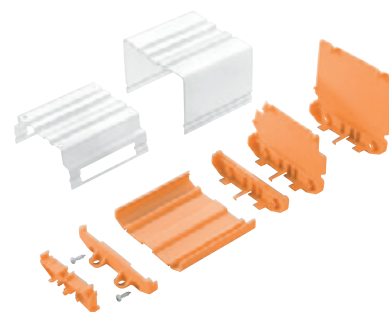

Technical data

General data	
Number of PCB per module	1
Thickness of PCB	1.6 (± 0.2) mm
Material	PVC/PA
Flammability class UL 94	V0
Colour of insulating material	orange / grey (Black on request)
Note	

Ordering data

Extruded profile	
2000 mm	orange
2000 mm	grey
100 0mm	grey
155 mm	orange
Intermediate piece	
5 mm	
15 mm	
25 mm	
30 mm	
45 mm	
End plate w. locking foot	
Without cover	grey, left version grey, right version
Locking foot	
	orange grey

With marking facilities	left version right version
Without marking facilities	left version right version
Central	intermediate foot

End plate for direct mounting	
Without cover	grey, left version grey, right version orange grey
For medium-high cover profile	orange grey
For high cover profile	orange grey
End plate for mounting rail installation	
Without cover	orange grey
For medium-high cover profile	orange grey
For high cover profile	orange grey

Cover profile 2000 mm	Medium-high
2000 mm	high
Screws	

Note

1
1.6 (± 0.2) mm
PVC/PA
V0
orange / grey (Black on request)

Type	Qty.	Order No.
PF RS 100 OR 2000MM A.1 V0	1	4144870000
PF RS 100 GR 2000MM A.1 V0	1	4010870000
PF RS 100 A.1 OR 155.5 V0	25	4148400000
RF 180 V2	20	1324460000
RF 180 GR V2	20	1773400000
AP 100 D V2	20	1185160000
AP 110 D V2	10	1185360000
AP 111 D V2	10	1185560000
AP 100 V2	20	1185060000
AP 110 V2	10	1185260000
AP 111 V2	10	1185460000
ADP 10 V2	1	4169320000
ADP 11 V2	1	4169330000
PTSC KB40X14	100	4019420000

Other lengths on request.

RS 122

Housing construction (plus 4 screws):
available as a rail mounting version (TS mounting)

- 2 end plates for rail mounted assembly with locking foot
- 2 or more locking feet
- additional intermediate foot
- 1 Extruded profile

Description

Takes PCB in 2 positions

Dimensions of the PCB

Thickness: 1.6 (±0.2) mm, width: +0.5 mm
i.e. length RS section = PCB length - 5 mm

Example:

PCB length 160 mm,

RS section = 160 mm - 5 mm = 155 mm

Dimensioned drawing

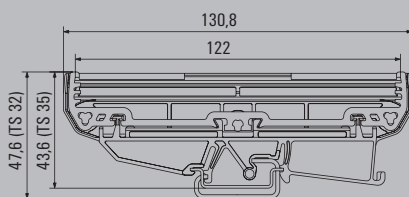

Technical data

General data

Number of PCB per module
Thickness of PCB
Material
Flammability class UL 94
Colour of insulating material

Note

Ordering data

Extruded profile	
2000 mm	orange
2000 mm	grey
1000 mm	grey
155 mm	orange

Intermediate piece

5 mm
15 mm
25 mm
30 mm
45 mm

End plate w. locking foot

Without cover	grey, left version
	grey, right version

Locking foot

	orange
	grey
With marking facilities	left version
	right version
Without marking facilities	left version
	right version
Central	intermediate foot

End plate for direct mounting

Without cover	grey, left version
	grey, right version
	orange
	grey
For medium-high cover profile	orange
	grey
For high cover profile	orange
	grey

End plate for mounting rail installation

Without cover	orange, left version
	orange, right version
	grey
For medium-high cover profile	orange
	grey
For high cover profile	orange
	grey

Cover profile	Medium-high
	high

Screws

Note

RS 122

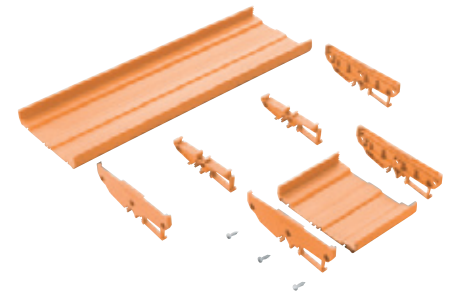

1
1.6 (± 0.2) mm
PVC/PA
V0
orange

Type	Qty.	Order No.
PF RS 122 OR 2000MM	10	1155940000

RF 108 OR	20	1020690000
-----------	----	------------

AP RF 122 LI OR	20	1020640000
-----------------	----	------------

AP RF 122 RE OR	20	1020650000
-----------------	----	------------

Other lengths on request.

OMNIMATE Housing Accessories

OMNIMATE Housing Accessories	Mounting foot	J.2
	Identification systems	J.2
	Screwdrivers	J.3

MTA

Snap-on foot for terminal rail



The MTA 45 mounting adapter enables many different modules to be securely attached to a terminal rail. The adapter, made of fibreglass-reinforced polyamide, ensures high stability and secure fixity to the terminal rail. It is assembled by simply clipping on, and disassembled by pushing up and tilting the module. No tools are required for this.

MOFU

Mounting foot

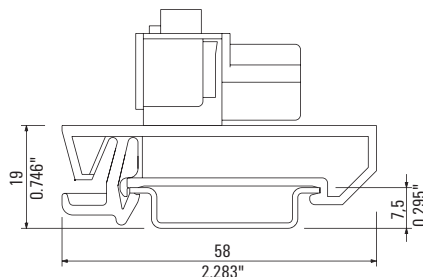

WS 10/5

WS 12/5

MultiCard marking



- WS 10/5 = 10 mm long x 5 mm wide
- WS 12/5 = 12 mm long x 5 mm wide
- Delivered as MultiCard 5 mats with 144 markers

J

Ordering data

Snap-on foot for TS 35			black
Type	Qty.	Order No.	
MTA 30 BK	45	1168970000	
MTA 45 BK	30	1962250000	

Ordering data

Colour			black
Type	Qty.	Order No.	
Mounting foot Mofu	20	0646210000	

Ordering data

Type	Length mm	Order No.
WS 10/5	10	1635000000
WS 12/5	12	1609860000

SDI

VDE-insulated slotted screwdriver

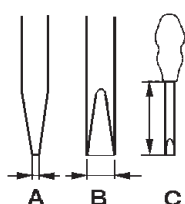

VDE-insulated slotted screwdriver, SDI

- DIN 7437, ISO 2380/2
- Output acc. to DIN 5264, ISO 2380/1
- SoftFinish® handle



Ordering data

Type	Dims (mm)	A	B	C	Order No.
SDI		0,4	2,5	75	9008370000
SDI		0,5	3,0	100	9008380000
SDI		0,6	3,5	100	9008390000
SDI		0,8	4,0	100	9008400000
SDI		1,0	4,5	125	9008910000
SDI		1,0	5,5	125	9008410000
SDI		1,2	6,5	150	9008420000
SDI		1,6	8,0	175	9008430000

SD

Slotted screwdriver with round blade

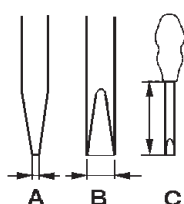

Slotted screwdriver with round blade, SD

- DIN 5265, ISO 2380/2
- Output acc. to DIN 5264, ISO 2380/1
- ChromTop tip
- SoftFinish® handle



Ordering data

Type	Dims (mm)	A	B	C	Order No.
SD		0,4	2,5	75	9009030000
SD		0,5	3,0	80	9008320000
SD		0,6	3,5	100	9008330000
SD		0,8	4,0	100	9008340000
SD		0,8	4,5	125	9009020000
SD		1,0	5,5	150	9008350000
SD		1,2	6,5	150	9009010000

Tension clamp terminal tool

Tool for PCB terminals with tension clamp connections

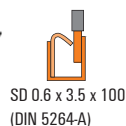
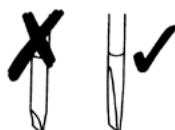

SD 0.6 x 3.5 x 100 (DIN 5264-A)

You do not need any special tool to connect or disconnect our tension clamp connections. The opening is designed to accommodate a standard 0.6 x 3.5 x 100 screwdriver to DIN 5264-A (with flat blade), also available from Weidmüller.

SDK PH

Crosshead screwdriver



Crosshead screwdriver PH (Philips)

- SDK PH DIN 5262, ISO 8764/2-PH
- Output acc. to ISO 8764-PH
- ChromTop tip
- SoftFinish® grip



Crosshead screwdriver PZ (PoziDrive)

- SDK PZ DIN 5262, ISO 8764/2-PZ
- Output acc. to ISO 8764-PZ
- ChromTop tip
- SoftFinish® grip



Ordering data PH

Type	Dims (mm)	A	B	C	Order No.
SDK PH0	0			60	9008470000
SDK PH1	1			80	9008480000
SDK PH2	2			100	9008490000
SDK PH3	3			150	9008500000

Ordering data PZ

Type	Dims (mm)	A	B	C	Order No.
SDK PZ1	1			80	9008530000
SDK PZ2	2			100	9008540000
SDK PZ3	3			150	9008550000

Technical appendix

Technical appendix	Materials	W.2
	Derating curve	W.5
	IEC clearance and creepage distances	W.6
	UL design-in recommendations for 600 V applications	W.10
	UL clearance and creepage distances	W.11
	SMT design-in recommendations	W.12
	Conductors	W.18

Insulating materials

Weidmüller uses different insulating materials because of the diverse requirements placed on our products. The insulating materials do not contain any hazardous substances. The use of cadmium-free materials is a very high priority. Our insulating materials contain neither pigments based on heavy metals nor any substances that lead to the formation of dioxin or furan.

Thermoplastics			
Plastic Abbreviation	Wemid PA66	Wemid GF	Polyamide PA
	<p>Wemid is a modified thermoplastic, its properties are specially tailored to meet the needs of our cable connectors. Advantages over PA are the improved fire protection and the higher sustained working temperature. WEMID meets the stringent requirements for use in railway carriages according to NF F 16-101.</p>	<p>Glass-fibre reinforced WEMID offers excellent dimensional stability and very good mechanical properties. This makes a difference when used as an end bracket. The material falls in the V-0 flammability class according to UL 94.</p>	<p>Polyamide (PA) is one of the most widely used engineering plastics. Advantages of this material are its good electrical and mechanical characteristics, its flexibility and resistance to breakage. In addition, PA offers good fire resistance on account of its chemical structure even without the addition of flame retardants.</p>
Description	<p>higher sustained working temperature</p> <p>improved fire resistance</p> <p>halogen-free and phosphor-free flame-retardant material</p> <p>low smoke produced in the event of fire</p> <p>permitted for use in railway applications following NF F 16-101 specifications</p>	<p>excellent dimensional stability</p> <p>very good mechanical characteristics</p> <p>halogen-free flame retardant material</p>	<p>flexible, resistant to breakage</p> <p>good electrical and mechanical characteristics</p> <p>self-extinguishing characteristic</p> <p>halogen-free flame retardant material</p>
Properties			
Specific volume resistance to IEC 60093	$\Omega \times \text{cm}$	10^{12}	10^{15}
Electric strength to IEC 60243-1	kV / mm	25	35
Tracking resistance (A) to IEC 60112	CTI	600	550
Upper max. permissible temperature	°C	120	120
Lower max. permissible temperature, static	°C	-50	-40
Flamability class to UL 94		V-0	V-0
Fire behaviour to railway standard		I2 / F2 *)	-

W

Thermoplastics

Polyamide PAGF	Polybutylene terephthalate PBT	Polybutylene terephthalate PBT (GF)	Polycarbonate PC	Liquid crystal polymer LCP (GF)
<p>Glass-fibre reinforced polyamide (PAGF) offers excellent dimensional stability and very good mechanical characteristics. This makes a difference when used as an end bracket. As compared to unreinforced PA, this material has flammability rating HB according to UL 94.</p>	<p>Thermoplastic polyester (PBT) offers excellent dimensional stability (hence its use in plug connectors) and a high constant operating temperature. Compared to other insulating materials, the creepage-current resistance is lower.</p>	<p>Thermoplastic polyester (PBT/glass fibre reinforced) offers excellent dimensional stability (hence its use in plug connectors) and a high constant operating temperature. Compared to other insulating materials, the creepage-current resistance is lower.</p>	<p>Polycarbonate (PC) is an impact-resistant (unbreakable), crystal-clear material which is not easily scratched. It is particularly suitable for use in transparent covers.</p>	<p>LCP (glass fibre reinforced) offers excellent dimensional stability, particularly at high temperatures. As the material is similar to PCBs and has a very low thermal expansion coefficient, it is particularly suitable for components that are soldered in the reflow oven.</p>
<p>excellent dimensional stability very good mechanical characteristics halogen-free flame retardant material</p>	<p>high dimensional stability good electrical and mechanical characteristics Flame retardants that do not form dioxin or furan.</p>	<p>high dimensional stability good electrical and mechanical characteristics Flame retardants that do not form dioxin or furan.</p>	<p>high dimensional stability high constant operating temperature high electrical insulation properties halogen-free flame retardant material</p>	<p>excellent dimensional stability high constant operating temperature minimal water absorption low thermal expansion coefficient</p>
<p>10¹² 30 500 100 -50 HB</p>	<p>10¹³ 28 200 115 -50 V-0</p>	<p>10¹³ 29 200 130 -50 V-0</p>	<p>10¹⁶ ≥ 30 ≥ 175 115 / 125 -50 V-2 / V-0 I2 / F2</p>	<p>10¹⁵ 35 175 240 -50 V-0 -</p>

Metals

Metals

All the metals used by Weidmüller are selected and processed with their surfaces treated according to the latest technical standards.

Steels

Steel parts are electrogalvanised and treated with an additional Weidmüller passivation technique, WInQ®. The surface protection conforms to the highest standards, is matched to the special requirements of the connection systems used and is RoHS-compatible (RoHS = Restriction of Hazardous Substances). Experience gained from storage in outdoor test racks at different locations (industrial, marine, tropical and normal atmospheres) has been incorporated into the design of the surface protection.

Zinc protects against corrosion for a long time even after the zinc coating has been partially damaged by scratches or pores. In the presence of an electrolyte, zinc acts as a cathode (i.e. negative) with respect to steel. The metal ions of the zinc migrate to the steel, which provides long-term protection for the parent metal.

Conductive materials

The current-carrying materials copper, brass and bronze are characterised by a high conductivity plus good mechanical properties. The surfaces are usually given a coating of tin, which creates an extremely good, "malleable" contact with a low contact resistance.

Apart from ensuring consistently good electrical properties, the tin coating provides excellent protection against corrosion. Solder connections are also given a coating of tin.

In order to guarantee the long-term solderability (shelf life), the brass parts are given an additional nickel coating as a diffusion barrier. The nickel coating provides effective protection against the loss of zinc atoms from the brass.

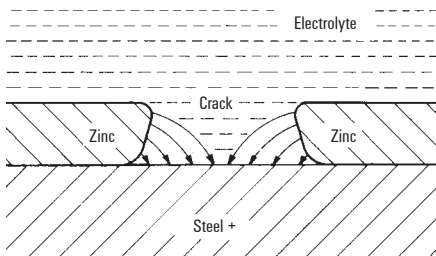

Derating curve (current-carrying capacity curve)

The **derating curve** shows which currents may flow continuously and simultaneously via all possible connections when the component is subjected to various ambient temperatures below its upper limit temperature.

The **upper limit temperature** of a component is the rated value determined by the materials used. The total of the ambient temperature plus the temperature rise caused by the current load (power loss at volume resistance) may not exceed the upper limit temperature of the component, otherwise it will be damaged or even completely ruined.

The current-carrying capacity is hence not a constant value, but rather decreases as the component ambient temperature increases.

Furthermore, the current-carrying capacity is influenced by the geometry of the component, the number of poles and the conductor(s) connected to it. The current-carrying capacity is determined empirically according to DIN IEC 605 12-3. To do this, the resulting component temperatures t_{b1} , t_{b2} ... and the ambient temperatures t_{u1} , t_{u2} are measured for three different currents I_1 , I_2 , I_3

The values are entered on a graph with a system of linear coordinates to illustrate the relationships between the currents, the ambient temperatures and the temperature rise in the component.

The **loading currents** are plotted on the y-axis, the **component ambient temperatures** on the x-axis.

A line drawn perpendicular to the x-axis at the upper limit temperature t_g of the component completes the system of coordinates.

The associated average values of the temperature rise in the component, $\Delta t_1 = t_{b1} - t_{u1}$, $\Delta t_2 = t_{b2} - t_{u2}$, ... are plotted for every current I_1 , I_2 , ... to the left of the perpendicular line. The points generated in this way are joined to form a roughly parabolic curve.

As it is practically impossible to choose components with the maximum permissible volume resistances for the measurements, the base curve must be reduced.

Reducing the currents to 80 % results in the **"derating curve"** in which the maximum permissible volume resistances and the measuring uncertainties in the temperature measurements are taken into account in such a way that they are suitable for practical applications, as experience has shown. If the derating curve exceeds the currents in the low ambient temperature zone, which is given by the current-carrying capacity of the conductor cross-sections to be connected, then the derating curve should be limited to the smaller current in this zone.

Base curve

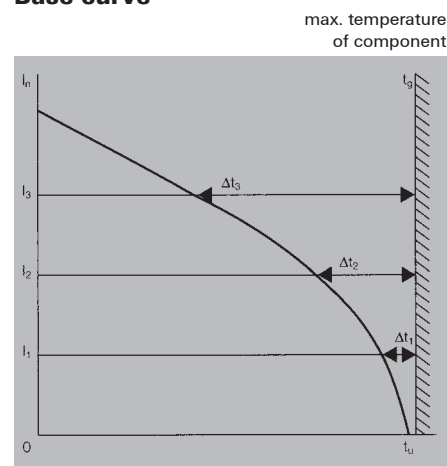

t_g = upper limit temperature of component
 t_u = ambient temperature
 I_n = current

Derating curve

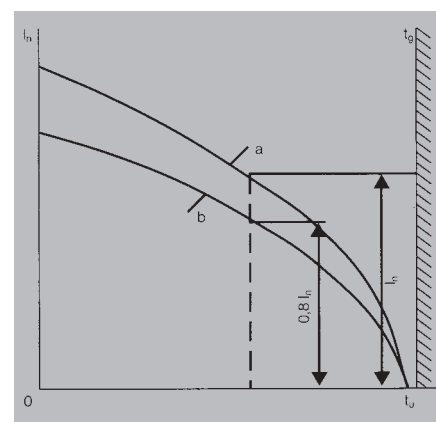

t_g = upper limit temperature of component
 t_u = ambient temperature
 I_n = current
 a = base curve
 b = reduced base curve (derating curve)

Example: derating curve for minimum and maximum number of poles

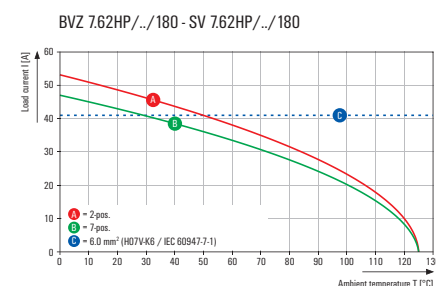

Design of clearance and creepage distances in electrical equipment

General:

Since April 1997 the sizing of clearance and creepage distances has been covered by DIN VDE 0110 part 1 "Insulation coordination for electrical equipment in low-voltage systems".

DIN VDE 0110 part 1 contains the modified edition of IEC Report 664-1 (see also IEC 664-1/Oct 1992). The design data resulting from these provisions is – if applicable – specified in this catalogue for each product.

Dimensioning of clearance and creepage distances to VDE 0110/Apr 1997 (IEC Report 664-1) "Insulation coordination for electrical equipment in low-voltage systems"

The provisions for insulation coordination result in the following relationships for dimensioning of clearance and creepage distances:

- **Clearances** are dimensioned according to the anticipated **overvoltages** taking into account the ratings of the **overvoltage protection precautions** in use and the anticipated environmental conditions taking into account the protective measures taken to prevent **pollution**.
- **Creepage distances** are dimensioned according to the **operating voltage** and the anticipated environmental conditions taking into account the **insulating materials** used and the protective measures taken to prevent **pollution**.

Dimensioning of clearances

Decisive for the dimensioning of clearances are the **rated impulse withstand voltages** shown in table 1, which are derived from the **overvoltage category** and the **phase-to-earth** voltage depending on the rated mains voltage (taking into account all types of supply systems).

The minimum clearances (up to site altitudes of 2000 m above mean sea level) are determined from table 2a based on the **rated impulse withstand voltage** and the **pollution severity**.

Note: Clearances that do not comply with case A must be subjected to an impulse withstand voltage test (see table 2a, footnote 1).

Table 1: Rated impulse withstand voltages for electrical equipment

Rated voltage of power supply system*) in V		Rated impulse withstand voltage in kV			
Three-phase systems	Single-phase systems with neutral point	Electrical equipment at the supply point of the installation (Overvoltage category IV)	Electrical equipment as part of the permanent installation (Overvoltage category III)	Electrical equipment to be connected to the permanent installation (Overvoltage category II)	Specially protected electrical equipment (Overvoltage category I)
	120 to 240	4,00	2,50	1,50	0,80
230/400 277/480		6,00	4,00	2,50	1,50
400/690 1000		8,00	6,00	4,00	2,50
		Values depend on the particular project or, if no values are available, the values above for 400/690 V can be used.			

*) to IEC 38

Category I is valid for specially rated equipment.

Category II is valid for technical committees responsible for electrical equipment specified for connecting to the mains power supply.

Category III is valid for technical committees responsible for installation materials, and for some specific technical committees.

Category IV is valid for power supply companies and particular projects.

Table 2a: Minimum clearances to VDE 0110-1/Apr 1997

Rated impulse withstand volt. in kV	Minimum clearance distances in mm for sites up to 2000 m above sea level										
	Case A (inhomogeneous field)				Case B (homogeneous field)						
	Pollution severity				Pollution severity						
	1	2	1)	3	4	1	2	1)	3	4	
0,33	0,01			0,80	1,60	0,01	0,20	0,20	0,80	1,60	
0,40	0,02		0,10			0,02					0,10
0,50	0,04	0,20				0,04					
0,60	0,06		0,12			0,06					0,12
0,80	0,10					0,10					
1,00	0,15		0,20			0,15					0,20
1,20	0,25	0,25		0,20		0,30	0,30	0,30	0,80	1,60	
1,50	0,50	0,25		0,30							
2,00	1,00	1,00		1,00		0,45	0,45				
2,50	1,50	1,50		1,50		0,60	0,60				
3,00	2,00	2,00		2,00	2,00	0,80	0,80				
4,00	3,00	3,00		3,00	3,00	1,20	1,20		1,20		
5,00	4,00	4,00		4,00	4,00	1,50	1,50		1,50		
6,00	5,50	5,50		5,50	5,50	2,00	2,00		2,00	2,00	
8,00	8,00	8,00		8,00	8,00	3,00	3,00		3,00	3,00	
10,00	11,00	11,00		11,00	11,00	3,50	3,50		3,50	3,50	
12,00	14,00	14,00		14,00	14,00	4,50	4,50		4,50	4,50	
15,00	18,00	18,00		18,00	18,00	5,50	5,50		5,50	5,50	

1) Pollution severity 2 is split for impulse voltages up to 1.00 kV (case A) or 1.20 kV (case B). These values apply for printed circuits but deviate from those in IEC Report 664.

The **pollution severity categories** are as follows:

Pollution severity category 1:
No pollution, or only dry, non-conductive pollution that has no influence.

Pollution severity category 2:
Non-conductive pollution only; occasional condensation may cause temporary conductivity.

Pollution severity category 3:
Conductive pollution, or dry, non-conductive pollution that is liable to be rendered conductive through condensation.

Pollution severity category 4:
Contamination results in constant conductivity, e.g. caused by conductive dust, rain or snow.

The following aspects apply to the **overvoltage categories** in accordance with the German standard DIN VDE 0110-1:

Electrical equipment fed directly from the low-voltage mains

Specification of a specific overvoltage category shall be based on the following:

– Equipment of *overvoltage category I* is equipment that is intended to be connected to the permanent electrical installation of a building. Measures to limit transient overvoltages to the specific level are taken outside the equipment, either in the permanent installation or between the permanent installation and the equipment.

– Equipment of *overvoltage category II* is equipment to be connected to the permanent electrical installation of a building.

Note: Examples of such equipment are household appliances, portable tools and similar loads.

– Equipment of *overvoltage category III* is equipment that is part of the permanent electrical installation and other equipment where a higher degree of availability is expected.

Note: Examples of such equipment are distribution boards, circuit-breakers, wiring systems (IEV 826-06-01, including cables, busbars, junction boxes, switches,

power sockets) in the permanent installation, and equipment for industrial use and some other equipment, e.g. stationary motors with permanent connections to the permanent installation.

– Equipment of *overvoltage category IV* is for use at or in the proximity of the incoming supply point of the electrical installations of buildings upstream of the main distribution board.

Table 3a: Single-phase 2- or 3-wire AC or DC systems

Rated voltage of the power supply (mains) ¹⁾	Voltages for table 4	
	For insulation phase-to-phase ¹⁾	For insulation phase-to-earth ¹⁾
	All systems	3-wire systems, neutr. point earthing
V	V	V
12,5	12,5	-
24	25	-
25		
30	32	-
42		
48	50	-
50 ^{**})		
60	63	-
30-60	63	32
100 ^{**})	100	-
110	125	-
120		
150 ^{**})	160	-
220	250	-
110-220	250	125
120-240		
300 ^{**})	320	-
220-440	500	250
600 ^{**})	630	-
480-960	1000	500
1000 ^{**})	1000	-

1) Phase-to-earth insulation levels for unearthed or impedance-earthed systems are equal to those of phase-to-phase because the operating voltage to earth of any phase can, in practice, reach full phase-to-phase voltage. This is because the actual voltage to earth is determined by the insulation resistance and capacitive reactance of each phase to earth; thus, a low (but acceptable) insulation resistance of one phase can earth it and raise the other two to full phase-to-phase voltage to earth.

*) It is assumed that the rated voltage of the electrical equipment is not lower than the nominal voltage of the power supply.

**) Because of the common changes, the meaning of the ** symbol has not been used in table 1; i.e. the / symbol indicates a 4-wire 3-phase distribution system. The lower value is the phase-to-neutral voltage, while the higher value is the phase-to-phase voltage. Where only one value is indicated, it refers to 3-wire, 3-phase systems and specifies the value phase-to-phase. The values given in table 1 are still taken into account in tables 3a and 3b by the ** symbol.

Table 3b: 3-phase 3- or 4-wire AC systems

Rated voltage of the power supply (mains) ¹⁾	Voltages for table 4			
	For insulation phase-to-phase ¹⁾	For insulation phase-to-earth ¹⁾		
		All systems	3-phase 4-wire systems with earthed neutral wire ²⁾	3-phase 3-wire systems unearthed ¹⁾ or phase-earthed
V	V	V	V	
60	63	32	63	
110/120/127	125	80	125	
150 ^{**})	160	-	160	
208	200	125	200	
220/230/240	250	160	250	
300 ^{**})	320	-	320	
380/400/415	400	250	400	
440	500	250	500	
480/500	500	320	500	
575	630	400	630	
600 ^{**})	630	-	630	
660/690	630	400	630	
720/830	800	500	800	
960	1000	630	1000	
1000 ^{**})	1000	-	1000	

1) Phase-to-earth insulation levels for unearthed or impedance-earthed systems are equal to those of phase-to-phase because the operating voltage to earth of any phase can, in practice, reach full phase-to-phase voltage. This is because the actual voltage to earth is determined by the insulation resistance and capacitive reactance of each phase to earth; thus, a low (but acceptable) insulation resistance of one phase can earth it and raise the other two to full phase-to-phase voltage to earth.

2) For electrical equipment for use in both 3-phase 4-wire and 3-phase 3-wire supplies, earthed and unearthed, use the values for 3-wire systems only.

*) It is assumed that the rated voltage of the electrical equipment is not lower than the nominal voltage of the power supply.

**) Because of the common changes, the meaning of the ** symbol has not been used in table 1; i.e. the / symbol indicates a 4-wire 3-phase distribution system. The lower value is the phase-to-neutral voltage, while the higher value is the phase-to-phase voltage. Where only one value is indicated, it refers to 3-wire, 3-phase systems and specifies the value phase-to-phase. The values given in table 1 are still taken into account in tables 3a and 3b by the ** symbol.

IEC clearance and creepage distances

Note: Examples of such equipment are electricity meters, circuit-breakers and ripple control units.

Note on application of pollution severity and overvoltage categories

The pollution severity and rated impulse withstand voltage derived from the overvoltage category are each specified in this catalogue and are product-related. In principle, the dimensioning of clearance and creepage distances, and the resulting specification of ratings for

electromechanical products (terminal blocks, terminal strips, PCB terminals/connectors) is based on pollution severity 3 and overvoltage category III considering all types of systems.

Dimensioning of creepage distances

Decisive for dimensioning of creepage distances are the rated voltages derived from the **system voltages** of the power supply for the respective **type of supply system** in conjunction with the **pollution severity** (classification, see "Clearances") and the **insulating material** used.

Taking into account tables 3a and 3b and the CTI (Comparative Tracking Index) of the insulating material, the minimum creepage distances are determined from table 4.

The insulating materials are subdivided into four groups according to their CTI (Comparative Tracking Index):

Insulating material	
I	600 ≤ CTI
II	400 ≤ CTI < 600
III a	175 ≤ CTI < 400
III b	100 ≤ CTI < 175

Table 4: Minimum creepage distances

Rated voltage U _{eff} or U _i in V	Creepage distance in mm											
	Printed circuits		Other electrical equipment	Pollution severity								
	Pollution severity		1	2			3			4		
	1	2	1	Insulating material group			Insulating material group			Insulating material group		
Insulating mat.	Insulating mat.	Insulating mat.	I	II	III	I	II	III ⁴⁾	I	II	III ⁴⁾	
10	0,025	0,04	0,08	0,40	0,40	0,40	1,00	1,00	1,00	1,60	1,60	1,60
12,5	0,025	0,04	0,09	0,42	0,42	0,42	1,05	1,05	1,05	1,60	1,60	1,60
16	0,025	0,04	0,10	0,45	0,45	0,45	1,10	1,10	1,10	1,60	1,60	1,60
20	0,025	0,04	0,11	0,48	0,48	0,48	1,20	1,20	1,20	1,60	1,60	1,60
25	0,025	0,04	0,125	0,50	0,50	0,50	1,25	1,25	1,25	1,70	1,70	1,70
32	0,025	0,04	0,14	0,53	0,53	0,53	1,30	1,30	1,30	1,80	1,80	1,80
40	0,025	0,04	0,16	0,56	0,80	1,10	1,40	1,60	1,80	1,90	2,40	3,00
50	0,025	0,04	0,18	0,60	0,85	1,20	1,50	1,70	1,90	2,00	2,50	3,20
63	0,040	0,63	0,20	0,63	0,90	1,25	1,60	1,80	2,00	2,10	2,60	3,40
80	0,063	0,10	0,22	0,67	0,95	1,30	1,70	1,90	2,10	2,20	2,80	3,60
100	0,10	0,16	0,25	0,71	1,00	1,40	1,80	2,00	2,20	2,40	3,00	3,80
125	0,16	0,25	0,28	0,75	1,05	1,50	1,90	2,10	2,40	2,50	3,20	4,00
160	0,25	0,40	0,32	0,80	1,10	1,60	2,00	2,20	2,50	3,20	4,00	5,00
200	0,40	0,63	0,42	1,00	1,40	2,00	2,50	2,80	3,20	4,00	5,00	6,30
250	0,56	1,00	0,56	1,25	1,80	2,50	3,20	3,60	4,00	5,00	6,30	8,00
320	0,75	1,60	0,75	1,60	2,20	3,20	4,00	4,50	5,00	6,30	8,00	10,00
400	1,00	2,00	1,00	2,00	2,80	4,00	5,00	5,60	6,30	8,00	10,00	12,50
500	1,30	2,50	1,30	2,50	3,60	5,00	6,30	7,10	8,00	10,00	12,50	16,00
630	1,80	3,20	1,80	3,20	4,50	6,30	8,00	9,00	10,00	12,50	16,00	20,00
800	2,40	4,00	2,40	4,00	5,60	8,00	10,00	11,00	12,50	16,00	20,00	25,00
1000	3,20	5,00	3,20	5,00	7,10	10,00	12,50	14,00	16,00	20,00	25,00	32,00

2) Insulating materials I, II, IIIa, IIIb
 3) Insulating materials I, II, IIIa
 4) Creepage distances are not determined in this range. Insulation group IIIb is generally not recommended for pollution severity 3 with voltages > 630 V, and is never recommended for pollution severity 4.



The comparative tracking index must be determined according to DIN IEC 112/VDE 0303 part 1 on the basis of specially prepared samples with test solution A.

Slots are taken into account in the measurement of creepage distances when their minimum width x is dimensioned according to the following table:

Pollution-severity	Minimum width x mm
1	0,25
2	1,0
3	1,5
4	2,5

If the associated clearance is less than 3 mm, the minimum slot width can be reduced to $1/3$ of the clearance.

Design-in recommendations: applications for 600 V in accordance with UL

Summary of the most important UL requirements:

- PCB components are approved to UL 1059 and are tested without a PCB or application environment.
- Applications are approved to UL 508 (or UL 508C Power Conversion Equipment, e.g. frequency converters).
- The application designer must refer to the application-related UL standards, not to UL 1059.
- UL 508C enables the use of field terminals approved to UL 1059 for 300 V to be used for 600 V applications under certain conditions.
- Weidmüller Powermate Range plug-in connectors and power terminals comply with the conditions and may be used for 600 V applications to UL 508C.
- For more detailed information, please refer to the drawing below.

The approval for higher voltages to UL 508C / UL 840:

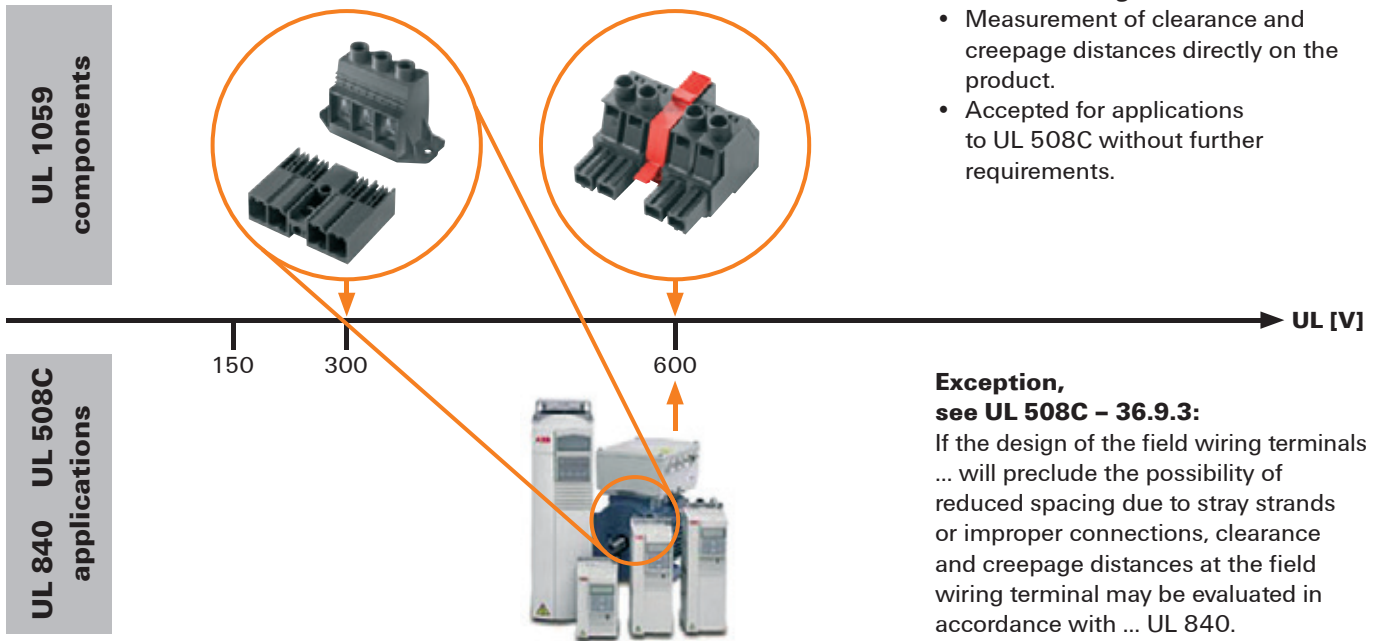

Extract from UL 508C: (36.9 Spacings for drives evaluated in accordance with UL 840)

- 36.9.1 Other than as noted in 36.9.2 and 36.9.3, clearance and creepage distances are able to be evaluated in accordance with the requirements in the Standard for Insulation Coordination Including Clearance and Creepage Distances for Electrical Equipment, UL 840. See 36.9.4 for details on applying UL 840.
- 36.9.2 Clearances between an uninsulated live part and the walls of a metal enclosure, including fittings for conduit or armored cable, shall be in accordance with 36.2.2. The clearances shall be determined by physical measurement.
- 36.9.3 The clearance and creepage distance at field wiring terminals shall be in accordance with the requirements in 36.3.1. Exception: When the design of the field wiring terminals precludes the possibility of reduced spacing due to stray strands or improper wiring installation, then clearance and creepage distances at these terminals are able to be evaluated in accordance with the Standard for Insulation Coordination Including Clearance and Creepage Distances for Electrical Equipment, UL 840.

The maximum voltage to be applied to the connector depends on the distance between two connections.

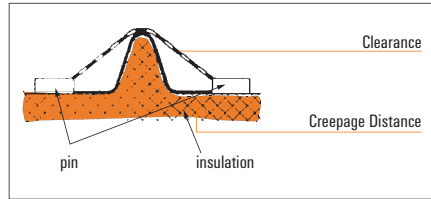

Two distances have to be taken in account:

- Clearance = shortest distance between two conductive parts (in air)
- Creepage distance = distance along surface

Comparison of UL clearance and creepage distances for UL 300 Volt

				min. clearance	
UL 1059	minimum spacing (Table 8.1)	151 - 300 V		6,4 mm	9,5 mm
UL 508C	minimum spacing (Table 36.1)	151 - 300 V		6,4 mm	9,5 mm
UL 508C	minimum spacing for products with known controlled transient voltages (Table 36,3)	Peak working voltage: 226 - 450 V / > 10 kVA		3,81 mm	5,08 mm
		Peak working voltage: 226 - 400 V / 500 VA - 10 kVA		2,54 mm	2,54 mm

Creepage distance determination related to UL 840

	Operating Voltage	Creepage distance for material group (CTI)*		
		I	II	IIIa & IIIb
UL 840 Table 9.1 Pollution degree 3 (alternate 36.9.3 UL 508C)	320 V	4,0 mm	4,5 mm	5,0 mm
UL 840 is similar to IEC 664-1	400 V	5,0 mm	5,6 mm	6,3 mm
UL 840 Table 9.1 Pollution degree 2 (alternate 36.9.3 UL 508C)	500 V	6,3 mm	7,1 mm	8,0 mm
UL 840 Table 9.1 Pollution degree 2 (alternate 36.9.3 UL 508C)	320 V	1,6 mm	2,2 mm	3,2 mm
UL 840 Table 9.1 Pollution degree 2 (alternate 36.9.3 UL 508C)	400 V	2,0 mm	2,8 mm	4,0 mm
UL 840 Table 9.1 Pollution degree 2 (alternate 36.9.3 UL 508C)	500 V	2,5 mm	3,6 mm	5,0 mm

Clearance determination related to UL 840 for 300 Volt

	Overvoltage category	Rated Impulse withstand voltage peak	minimum Clearance (600V)
UL 840 Table 8.1 Pollution degree 3 (alternate 36.9.3 UL 508C)	II	2,5 kV	1,5 mm
UL 840 Table 8.1 Pollution degree 3 (alternate 36.9.3 UL 508C)	III	4,0 kV	3,0 mm
UL 840 is similar to IEC 664-1	IV	6,0 kV	5,5 mm
UL 840 Table 8.1 Pollution degree 2 (alternate 36.9.3 UL 508C)	II	2,5 kV	1,5 mm
UL 840 Table 8.1 Pollution degree 2 (alternate 36.9.3 UL 508C)	III	4,0 kV	3,0 mm
UL 840 Table 8.1 Pollution degree 2 (alternate 36.9.3 UL 508C)	IV	6,0 kV	5,5 mm

300 V

Comparison of UL clearance and creepage distances for UL 600 Volt

				min. clearance	
UL 1059	minimum spacing (Table 8.1)	301 - 600 V		9,5 mm	12,7 mm
UL 508C	minimum spacing (Table 36.1)	151 - 300 V		9,5 mm	12,7 mm
UL 508C	minimum spacing for products with known controlled transient voltages (Table 36,3)	Peak working voltage: 451 - 900 V / > 10 kVA		7,62 mm	10,16 mm
		Peak working voltage: 451 - 900 V / 500 VA - 10 kVA		5,08 mm	5,08 mm

Creepage distance determination related to UL 840

	Operating Voltage	Creepage distance for material group (CTI)*		
		I	II	IIIa & IIIb
UL 840 Table 9.1 Pollution degree 3 (alternate 36.9.3 UL 508C)	630 V	8,0 mm	9,0 mm	10,0 mm
UL 840 is similar to IEC 664-1	800 V	10,0 mm	11,0 mm	12,5 mm
UL 840 is similar to IEC 664-1	1000 V	12,5 mm	14,0 mm	16,0 mm
UL 840 Table 9.1 Pollution degree 2 (alternate 36.9.3 UL 508C)	630 V	3,2 mm	4,5 mm	6,3 mm
UL 840 Table 9.1 Pollution degree 2 (alternate 36.9.3 UL 508C)	800 V	4,0 mm	5,6 mm	8,0 mm
UL 840 Table 9.1 Pollution degree 2 (alternate 36.9.3 UL 508C)	1000 V	5,0 mm	7,1 mm	10,0 mm

Clearance determination related to UL 840 for 600 Volt

	Overvoltage category	Rated Impulse withstand voltage peak	minimum Clearance (600V)
UL 840 Table 8.1 Pollution degree 3 (alternate 36.9.3 UL 508C)	II	4,0 kV	3,0 mm
UL 840 Table 8.1 Pollution degree 3 (alternate 36.9.3 UL 508C)	III	6,0 kV	5,5 mm
UL 840 is similar to IEC 664-1	IV	8,0 kV	8,0 mm
UL 840 Table 8.1 Pollution degree 2 (alternate 36.9.3 UL 508C)	II	4,0 kV	3,0 mm
UL 840 Table 8.1 Pollution degree 2 (alternate 36.9.3 UL 508C)	III	6,0 kV	5,5 mm
UL 840 Table 8.1 Pollution degree 2 (alternate 36.9.3 UL 508C)	IV	8,0 kV	8,0 mm

600 V

Guideline: relationship between approvals

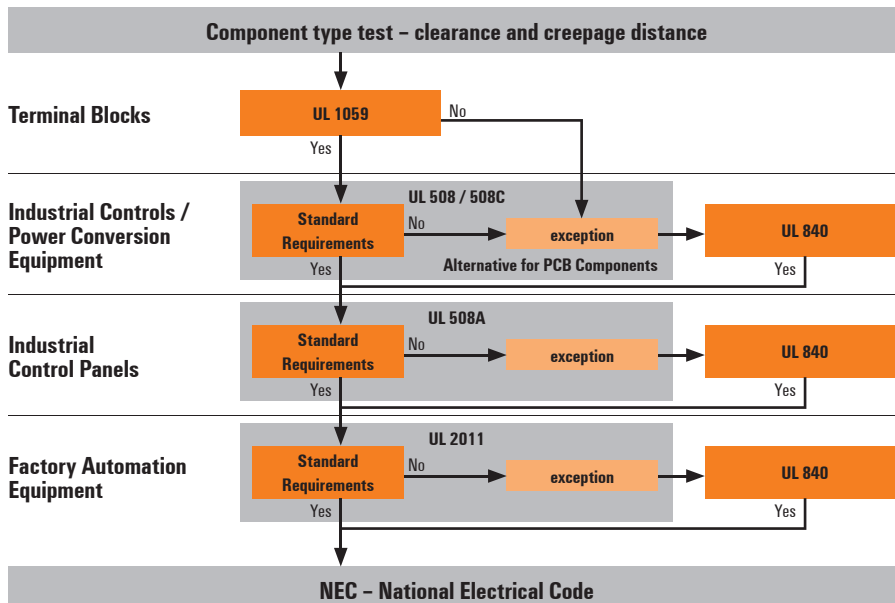

Weidmüller connectors in the reflow soldering process

The PCB assembly process has undergone a fundamental change in recent years. The conventional through-hole mounting technology (Through Hole Technology, THT) has been increasingly replaced by surface mounting technology (SMT). The reasons for this was the increasing demands of miniaturisation, higher functional density and lower manufacturing costs. The progress made in the development of surface mounted devices (SMD), that allowed the development of the SMT manufacturing process in the first place has also played a role. SMT is now the accepted standard in PCB manufacturing. There are still some components, in the main electro-mechanical components like connectors or relays, which are not available in a SMD version, they are therefore mounted following the SMT process using the classical THT assembly onto the PCB. Weidmüller has developed a product range for the through hole reflow process (THR), that makes wired component parts usable in the SMT process and allows 100 % processing in the SMT production line.

Through-hole reflow is a process for linking THT components with the SMT reflow soldering process. In addition to just SMD assembly, the SMD components with THR can be placed onto the SMT printed-circuit board together with wired components and be soldered in the reflow process. The THR process was developed from the realisation that stable soldering connections are still necessary with heavy components such as coils or transformers, as well as wherever mechanical forces come to bear on the printed-circuit boards, (such as with connection terminals, plug-and-socket connectors or relay sockets). SMD soldered joints are less suited for heavy components under substantial mechanical stress.

A SMT compatible product is always a compromise between optimal SMT capability and the stability of the solder connection. THR ensures a stable connection of the THT components to the PCB using the push-through pins. At the same time this ensures 100 % compatibility with the SMT process.

Benefits of THR:

- stable connection to the PCB
- only one soldering process
- No longer a need for hand or wave soldering
- automatic assembly
- lower production costs



In order to use THR components in the SMT process, they must meet certain requirements.

Stability in a new dimension

Our pin headers are made of glass-fibre reinforced LCP (liquid crystal polymers). This guarantees a high level of shape stability. The material's excellent temperature characteristics and the built-in grid space are excellent for the SMT process as well as "lead-free soldering".

The benefits:

- High temperature resistance
- Melting point of 335 °C
- Free from halogens
- Low thermal expansion coefficient
- Should be processed without drying

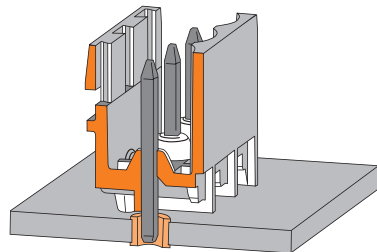

Remains true even to the pitches

Weidmüller's makes its male headers SL-SMT from LCP (liquid crystal polymer) to prevent undesirable dimensional changes caused by water absorption during storage. This ensures the highest pitch accuracy, even at high pin counts and secures the placement process.

The basis for high quality, reliability and efficiency

THR technology

THR soldering process is the processing of components that are inserted through a hole in the PCB and then soldered along with the other SMT components. In this method the components themselves must be able to withstand the higher temperatures of the SMT process.

Through hole technology in the SMT process

The placement process of PCBs has undergone a fundamental change in recent years. The conventional through hole mounting technique (THT) was increasingly replaced by the surface mounting process (SMT). SMT is now the accepted standard for PCB manufacture.

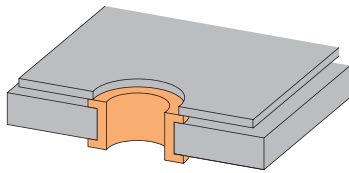

“Design in” – “Design out” from experience

Standard-process parameters help when drafting the printed-circuit board and template layout. Weidmüller recommends pin headers with short pins of 1.5 mm length. The following parameters have to be determined for the printed-circuit board design:

- Mounting hole diameter
- Soldering terminal diameter
- Stencil hole diameter
(with sufficient paste filling)
- Stencil hole diameter
(with insufficient paste filling)

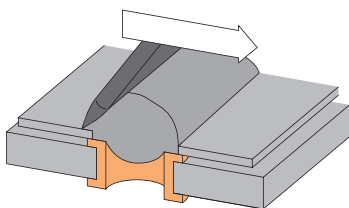

Paste printing – low volume in the best shape

Weidmüller SL-SMT pin headers have short octagonal pins with a chamfered pin end to keep the required paste volume as low as possible. Due to the pin length of just 1.5 mm for standard PCBs with a 1.6 mm thickness, an optimal solder joint shape can be achieved with a paste filling of approximately 90 %.

In addition, most normal one layer stencils for fine pitch techniques and the standard process parameters for squeegee speed and printing can be used.

Unbeatable advantage: the paste is pushed out of the placement hole during the placement process.

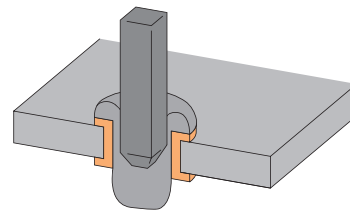

Assembly – short pins – great performance

Due to the shorter pins of 1.5 mm, you can have a higher packing volume for tape on reel or tray. This is also supported on the one side by the fact that SL-SMT male headers have a low profile, and also the reduced packaging height. Standard and anti-static packaging also allows fully automatic assembly with the commonly available Pick & Place systems. Outstanding advantages are offered by the short pins of the SL-SMT and the optimising of the travel height as well as the precision of the pin end position. Additionally, collisions between the components and the PCB can be completely avoided. At the same time, the SMT optimised male headers from Weidmüller increase the assembly strength due to their low weight.

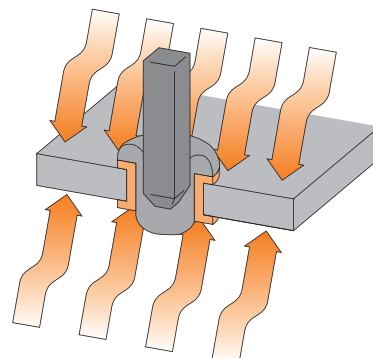

Reflow solder – the material of the future

High temperature resistant, halogen free insulating material LCP (Liquid Crystal Polymer) has a melting point of 335 °C. It not only has high dimensional stability, but also good resistance to the heat of soldering. Our SL-SMT male headers made from LCP are future proof, and can be used in lead-free solder processes. This leads to another key advantage of LCP: though its low thermal expansion coefficient, the bending of an assembly following the soldering process is avoided.

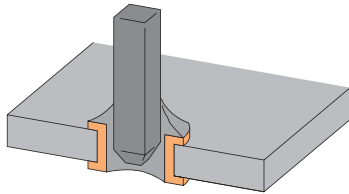

Quality control – control is better

To determine the quality of the solder joints of the THR components with short or long pins, Weidmüller has chosen the quick and simple checking using optical inspection, or X-ray examination. This meets the requirements of the internationally recognised norms and standards.

Our specially designed SL-SMT male headers allow optical inspection of the primary side of a PCB even for varieties with 180° outlet direction. This meets the requirements for in-process quality control.

Design recommendations

Solder paste volume and filling degree for 1.2 mm pin diameter.

The volume of paste and hence the degree of filling of the solder paste in the paste printing method is critical for optimum soldering results in the SMT process. We recommend determining the quantity of solder paste as follows:

Volume of paste (or rather, degree of filling):

for solder joint filling and solder joint form within the tolerances to IPC-A610

Male conn. (open and closed):	2 to 8 poles	9 to 24 poles
Male conn. (solder flange LF):	-	2 to 24 poles
Recommended finished hole I.D. *1):	$d_i = 1,4^{+0,1}$ mm	$d_i = 1,5^{+0,1}$ mm
	Paste volume V_p [mm ³] / filling level f_p [%] after stencil print	
Minimum solder joint shape	2,4 mm ³ / 70 %	3,1 mm ³ / 85 %
Optimum solder joint shape	2,9 mm ³ / 90 %	3,5 mm ³ / 100 %

Valid with the following parameters for all SL-SMT variations:

Male connector:

Pin length = **L** [mm] = 1,5^{-0,3}
 Pin diameter = **d** [mm] = 1,2

PCB:

Thickness = **H** [mm] = 1,6
 Placement hole = metallised
 Placement hole inner diameter ID = **d_i** [mm] = see table¹⁾
 Placement hole outer diameter OD = **d_A** [mm] = 2,3
 Positioning tolerance to IEC 326-3 = very fine

Stencil:

Thickness = **D_s** [µm] = 120 - 180
 Stencil hole diameter = **d_s** [mm] = 2,1²⁾

Solder paste:

Solder paste particle size [µm] = 20 - 40 = Type 3
 Evaporation volume of solder paste [%] = approx. 50

Process:

Stencil print method = squeegee print, single
 Filling level in placement hole = **f_p** [%] = see table
 Method for automatic assembly = pick&place
 Temperature profile = to EN 61760-1

¹⁾ Tolerances for components, PCBs and automatic machines must be taken into account.

²⁾ Stencil hole diameter approx. 10 % smaller than placement hole outer diameter **d_A**

Recommendations for S2C-SMT and SC-SMT 3.81 see:

<http://catalog.weidmueller.com>

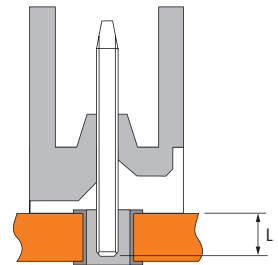

Male connector parameters

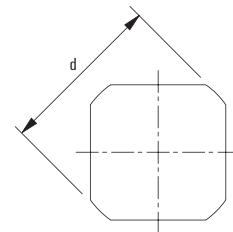

Pin cross-section

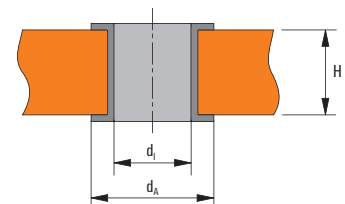

PCB parameters

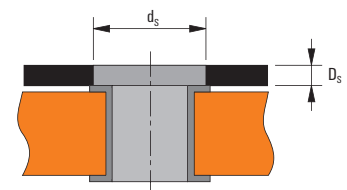

Stencil parameters

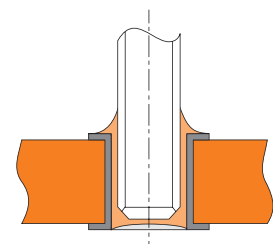

Optimum solder joint form

Quality control

Quality control completes the SMT production process. The goal in this process step is, using appropriate techniques, to check the quality of the solder joints of the THR components with short or long pins quickly and easily. The quality control rules for the THR solder technique are the same as for flow or wave soldering of THT components.

Control process:

The process quality control can be achieved by using various methods. Currently optical or X-ray examination is mostly used. The optical examination evaluates the shape, reflectivity and colour of the solder joints.

In the manual process, a magnifying glass or microscope is used, in the automatic process a computer controlled camera and software based image analysis is used.

In X-ray inspection, however, radiographic evaluation using automated X-ray microscopy is carried out. An important control factor are destructive testing in addition to the inspection process. Random samples are taken and used to verify measurable quantities:

- Analysis of the filling behaviour by cutting through the solder joint
- Mechanical testing of the pin pull-out resistance from the contacts

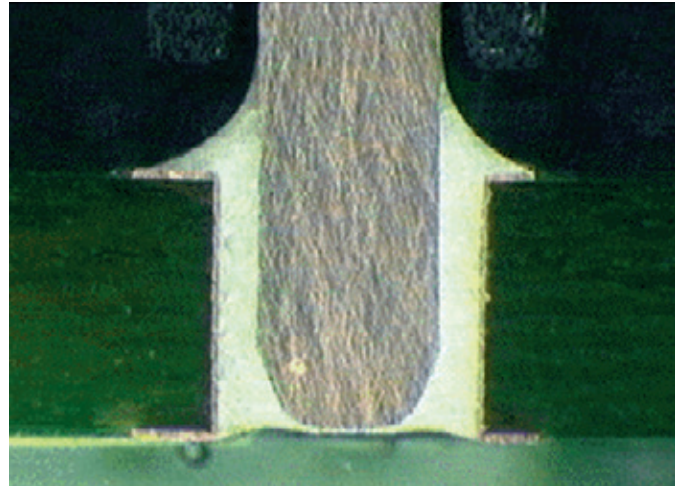

Cutting through the THR solder joint with the short pin

Norms and standards:

To make quality control more objective, norms and standards have been introduced over the recent years. In addition to other acceptance criteria for the manufacturing of electronic components, the quality control assessment criteria of the IPC-A-610E Norm are globally recognised.

According to IPC-A-610E quality requirements, THR solder joints are divided into three classes. For industrial applications where high power demands are made, Class 3 is the usual requirement. The following values are set for the five assessment criteria:

- The primary side solder wetting coverage (i.e. the insertion side from the view of the component), connection and sleeve should not be less than 270°.
- The vertical solder filling must be at least 75 %.

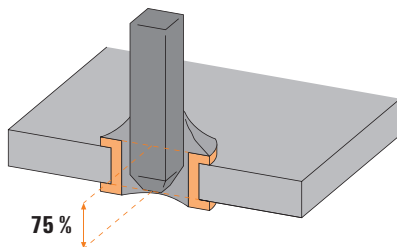

Measuring the filling level of through hole solder joints according to IPC-A-610E

- The secondary side solder wetting coverage (i.e. the underside from the view of the component) should not be less than 330°.
- Solder wetting of the solder pads (i.e. remains of the original ring of the THR solder joint) on the primary side is to be 0 %.
- Solder wetting of the solder pads on the secondary side must be at least 75 %.

These standards produce many demands on the wired components in the quality control. It should be noted that, in the THR process, there are typically two different construction types:

- Short pins when compared to the PCB thickness
- Longer pins when compared to the PCB thickness (about 1 to 1.5 mm protrusion)

For short pin construction there are the following requirements:

- The solder joints on the primary side of the PCB must be visible.
- For components with pins under the insulating body, the height of the component over the PCB must be sufficient to allow optical inspection.

For long pins, there are the following requirements:

- The solder joints on the secondary side must be visible.
- Solder joints on the primary side are, however, not required.

Additionally, in destructive testing with THR components there are requirements placed on the PCB itself. To control the quality of the PCB construction, the pull out strength of the solder pins from the solder joint is tested.

Required pull out strength:

- with short pins: approximately > 150 N.
- for long pins with a solder meniscus on the primary and secondary sides: approximately 220 N.

In comparison,

For surface connections for SMD components the required pull-out strength is only about 15 - 20 N.

According to IPC-A-610 Revision E-2010, section 7.3.3 the use of pins that are shorter than the PCB thickness is permissible in principle.

Conversion table

AWG to mm² conductors

AWG is the abbreviation for “**A**merican **W**ire **G**auge”. This designation bears no resemblance to the actual cross-section of the conductor.

The relationship between AWG and mm² is shown in the following table.

AWG	mm ²
28	0,08
26	0,13
24	0,21
22	0,32
20	0,52
19	0,65
18	0,82
17	1,04
16	1,31
15	1,65
14	2,08
13	2,63
12	3,31
11	4,17
10	5,26
9	6,63
8	8,37
7	10,55
6	13,30
5	16,77
4	21,15
3	26,67
2	33,63
1	42,41
0	53,48

Index

Index	Index Type	X.2
	Index Order No.	X.38
	Addresses worldwide	X.76

Type	Order No.	Page
A		
ADP 1/HP1 1M	048520000	1.44
ADP 10	4169320000	1.48
ADP 11	4169330000	1.48
ADP 5	4167150000	1.46
ADP 6	4167180000	1.46
AP 100	1185060000	1.48
AP 100 D	1185160000	1.48
AP 110	1185260000	1.48
AP 110 D	1185360000	1.48
AP 111	1185460000	1.48
AP 111 D	1185560000	1.48
AP 45/LI	8143910000	1.44
AP 45/LI DI	8140870000	1.44
AP 45/LI OR	1011590000	1.44
AP 45/RE	8143900000	1.44
AP 45/RE DI	8140860000	1.44
AP 45/RE OR	1011600000	1.44
AP 80	1324260000	1.46
AP 80	8320300000	1.46
AP 80 D	1324360000	1.46
AP 85	1411060000	1.46
AP 85 D	1411060000	1.46
AP 86	1410960000	1.46
AP 86 D	1411160000	1.46
AP 90 GR	1961890000	1.47
AP 90 OR	1961880000	1.47
AP MCZ1 5	8389030000	1.39
AP RF 122 LI OR	1020640000	1.49
AP RF 122 RE OR	1020650000	1.49
AP RF80 LI	8156210000	1.46
AP RF80 RE	8156200000	1.46

Type	Order No.	Page
B		
B2CF 3.50/04/180 SN BK BX	1277460000	C.12
B2CF 3.50/04/180 SN OR BX	1277270000	C.12
B2CF 3.50/04/180F SN BK BX	1277860000	C.13
B2CF 3.50/04/180F SN OR BX	1277650000	C.13
B2CF 3.50/04/180LR SN BK BX	1278230000	C.13
B2CF 3.50/04/180LR SN OR BX	1278040000	C.13
B2CF 3.50/06/180 SN BK BX	1277470000	C.12
B2CF 3.50/06/180 SN OR BX	1277280000	C.12
B2CF 3.50/06/180F SN BK BX	1277870000	C.13
B2CF 3.50/06/180F SN OR BX	1277670000	C.13
B2CF 3.50/06/180LR SN BK BX	1278240000	C.13
B2CF 3.50/06/180LR SN OR BX	1278050000	C.13
B2CF 3.50/08/180 SN BK BX	1277480000	C.12
B2CF 3.50/08/180 SN OR BX	1277290000	C.12
B2CF 3.50/08/180F SN BK BX	1277880000	C.13
B2CF 3.50/08/180F SN OR BX	1277680000	C.13
B2CF 3.50/08/180LR SN BK BX	1278250000	C.13
B2CF 3.50/08/180LR SN OR BX	1278060000	C.13
B2CF 3.50/10/180 SN BK BX	1277490000	C.12
B2CF 3.50/10/180 SN OR BX	1277310000	C.12
B2CF 3.50/10/180F SN BK BX	1277890000	C.13
B2CF 3.50/10/180F SN OR BX	1277690000	C.13
B2CF 3.50/10/180LR SN BK BX	1278260000	C.13
B2CF 3.50/10/180LR SN OR BX	1278070000	C.13
B2CF 3.50/12/180 SN BK BX	1277510000	C.12
B2CF 3.50/12/180 SN OR BX	1277320000	C.12
B2CF 3.50/12/180F SN BK BX	1277900000	C.13
B2CF 3.50/12/180F SN OR BX	1277700000	C.13
B2CF 3.50/12/180LR SN BK BX	1278270000	C.13
B2CF 3.50/12/180LR SN OR BX	1278080000	C.13
B2CF 3.50/14/180 SN BK BX	1277520000	C.12
B2CF 3.50/14/180 SN OR BX	1277330000	C.12
B2CF 3.50/14/180F SN BK BX	1277910000	C.13
B2CF 3.50/14/180F SN OR BX	1277700000	C.13
B2CF 3.50/14/180LR SN BK BX	1278280000	C.13
B2CF 3.50/14/180LR SN OR BX	1278090000	C.13
B2CF 3.50/16/180 SN BK BX	1277530000	C.12
B2CF 3.50/16/180 SN OR BX	1277340000	C.12
B2CF 3.50/16/180F SN BK BX	1277920000	C.13
B2CF 3.50/16/180F SN OR BX	1277700000	C.13
B2CF 3.50/16/180LR SN BK BX	1278290000	C.13
B2CF 3.50/16/180LR SN OR BX	1278100000	C.13
B2CF 3.50/18/180 SN BK BX	1277540000	C.12
B2CF 3.50/18/180 SN OR BX	1277350000	C.12
B2CF 3.50/18/180F SN BK BX	1277930000	C.13
B2CF 3.50/18/180F SN OR BX	1277750000	C.13
B2CF 3.50/18/180LR SN BK BX	1278300000	C.13
B2CF 3.50/18/180LR SN OR BX	1278110000	C.13
B2CF 3.50/20/180 SN BK BX	1277550000	C.12
B2CF 3.50/20/180 SN OR BX	1277360000	C.12
B2CF 3.50/20/180F SN BK BX	1277940000	C.13
B2CF 3.50/20/180F SN OR BX	1277760000	C.13
B2CF 3.50/20/180LR SN BK BX	1278310000	C.13
B2CF 3.50/20/180LR SN OR BX	1278120000	C.13
B2CF 3.50/22/180 SN BK BX	1277560000	C.12
B2CF 3.50/22/180 SN OR BX	1277370000	C.12
B2CF 3.50/22/180F SN BK BX	1277950000	C.13
B2CF 3.50/22/180F SN OR BX	1277700000	C.13
B2CF 3.50/22/180LR SN BK BX	1278320000	C.13
B2CF 3.50/22/180LR SN OR BX	1278130000	C.13
B2CF 3.50/24/180 SN BK BX	1277570000	C.12
B2CF 3.50/24/180 SN OR BX	1277380000	C.12
B2CF 3.50/24/180F SN BK BX	1277970000	C.13

Type	Order No.	Page
B2CF 3.50/24/180F SN OR BX	1277800000	C.13
B2CF 3.50/24/180LR SN BK BX	1278340000	C.13
B2CF 3.50/24/180LR SN OR BX	1278140000	C.13
B2CF 3.50/26/180 SN BK BX	1277580000	C.12
B2CF 3.50/26/180 SN OR BX	1277390000	C.12
B2CF 3.50/26/180F SN BK BX	1277980000	C.13
B2CF 3.50/26/180F SN OR BX	1277790000	C.13
B2CF 3.50/26/180LR SN BK BX	1278350000	C.13
B2CF 3.50/26/180LR SN OR BX	1278150000	C.13
B2CF 3.50/28/180 SN BK BX	1277590000	C.12
B2CF 3.50/28/180 SN OR BX	1277410000	C.12
B2CF 3.50/28/180F SN BK BX	1277990000	C.13
B2CF 3.50/28/180F SN OR BX	1277810000	C.13
B2CF 3.50/28/180LR SN BK BX	1278370000	C.13
B2CF 3.50/28/180LR SN OR BX	1278170000	C.13
B2CF 3.50/30/180 SN BK BX	1277610000	C.12
B2CF 3.50/30/180 SN OR BX	1277420000	C.12
B2CF 3.50/30/180F SN BK BX	1278000000	C.13
B2CF 3.50/30/180F SN OR BX	1277820000	C.13
B2CF 3.50/30/180LR SN BK BX	1278380000	C.13
B2CF 3.50/30/180LR SN OR BX	1278180000	C.13
B2CF 3.50/32/180 SN BK BX	1277620000	C.12
B2CF 3.50/32/180 SN OR BX	1277430000	C.12
B2CF 3.50/32/180F SN BK BX	1278010000	C.13
B2CF 3.50/32/180F SN OR BX	1277830000	C.13
B2CF 3.50/32/180LR SN BK BX	1278390000	C.13
B2CF 3.50/32/180LR SN OR BX	1278190000	C.13
B2CF 3.50/34/180 SN BK BX	1277630000	C.12
B2CF 3.50/34/180 SN OR BX	1277440000	C.12
B2CF 3.50/34/180F SN BK BX	1278020000	C.13
B2CF 3.50/34/180F SN OR BX	1277840000	C.13
B2CF 3.50/34/180LR SN BK BX	1278400000	C.13
B2CF 3.50/34/180LR SN OR BX	1278200000	C.13
B2CF 3.50/36/180 SN BK BX	1277640000	C.12
B2CF 3.50/36/180 SN OR BX	1277450000	C.12
B2CF 3.50/36/180F SN BK BX	1278030000	C.13
B2CF 3.50/36/180F SN OR BX	1277850000	C.13
B2CF 3.50/36/180LR SN BK BX	1278410000	C.13
B2CF 3.50/36/180LR SN OR BX	1278210000	C.13
B2L 3.50AH 10 SW	1781580000	D.4
B2L 3.50AH 12 SW	1781590000	D.4
B2L 3.50AH 14 SW	1781600000	D.4
B2L 3.50AH 16 SW	1781610000	D.4
B2L 3.50AH 18 SW	1781620000	D.4
B2L 3.50AH 20 SW	1781630000	D.4
B2L 3.50AH 22 SW	1781640000	D.4
B2L 3.50AH 24 SW	1781650000	D.4
B2L 3.50AH 26 SW	1781660000	D.4
B2L 3.50AH 28 SW	1781670000	D.4
B2L 3.50AH 30 SW	1781680000	D.4
B2L 3.50AH 32 SW	1781690000	D.4
B2L 3.50AH 34 SW	1781700000	D.4
B2L 3.50AH 36 SW	1781710000	D.4
B2L 3.50AH 6 SW	1781560000	D.4
B2L 3.50AH 8 SW	1781570000	D.4
B2L 3.50/06/180FQV3 SN BK BX	1944670000	C.19
B2L 3.50/06/180LHV3 SN BK BX	1944750000	C.19
B2L 3.50/06/180QV3 SN BK BX	1944590000	C.18
B2L 3.50/08/180FQV4 SN BK BX	1944680000	C.19
B2L 3.50/08/180LHV4 SN BK BX	1944760000	C.19
B2L 3.50/08/180QV4 SN BK BX	1944600000	C.19
B2L 3.50/10/180FQV5 SN BK BX	1944690000	C.19
B2L 3.50/10/180LHV5 SN BK BX	1944770000	C.19
B2L 3.50/10/180QV5 SN BK BX	1944610000	C.18
B2L 3.50/12/180FQV6 SN BK BX	1944700000	C.19
B2L 3.50/12/180LHV6 SN BK BX	1944780000	C.19
B2L 3.50/12/180QV6 SN BK BX	1944620000	C.18
B2L 3.50/14/180FQV7 SN BK BX	1944710000	C.19
B2L 3.50/14/180LHV7 SN BK BX	1944790000	C.19
B2L 3.50/14/180QV7 SN BK BX	1944630000	C.18
B2L 3.50/16/180FQV8 SN BK BX	1944720000	C.19
B2L 3.50/16/180LHV8 SN BK BX	1944800000	C.19
B2L 3.50/16/180QV8 SN BK BX	1944640000	C.19
B2L 3.50/18/180FQV9 SN BK BX	1944730000	C.19
B2L 3.50/18/180LHV9 SN BK BX	1944810000	C.19
B2L 3.50/18/180QV9 SN BK BX	1944650000	C.18
B2L/S2L 3.5 KO OR	1849730000	D.10
B2L/S2L 3.5 KO SW	1849740000	D.10
BBDF BK	1307580000	D.5
BBDF OR	1307570000	D.5
BCF 3.81/02/180 SN BK BX	1969890000	C.112
BCF 3.81/02/180 SN OR BX	1969900000	C.112
BCF 3.81/02/180F SN BK BX	1971500000	C.113
BCF 3.81/02/180F SN OR BX	1970300000	C.113
BCF 3.81/02/180LR SN BK BX	1972600000	C.113
BCF 3.81/02/180LR SN OR BX	1972200000	C.113
BCF 3.81/03/180 SN BK BX	1969920000	C.112
BCF 3.81/03/180 SN OR BX	1969100000	C.112
BCF 3.81/03/180F SN BK BX	1971570000	C.113
BCF 3.81/03/180F SN OR BX	1970330000	C.113
BCF 3.81/03/180LR SN BK BX	1972610000	C.113
BCF 3.81/03/180LR SN OR BX	1972210000	C.113
BCF 3.81/04/180 SN BK BX	1969950000	C.112
BCF 3.81/04/180 SN OR BX	1969110000	C.112
BCF 3.81/04/180F SN BK BX	1971590000	C.113
BCF 3.81/04/180F SN OR BX	1970370000	C.113
BCF 3.81/04/180LR SN BK BX	1972620000	C.113
BCF 3.81/04/180LR SN OR BX	1972220000	C.113
BCF 3.81/05/180 SN BK BX	1969970000	C.112

Type	Order No.	Page
BCF 3.81/05/180 SN OR BX	1969120000	C.112
BCF 3.81/05/180F SN BK BX	1971620000	C.113
BCF 3.81/05/180F SN OR BX	1970380000	C.113
BCF 3.81/05/180LR SN BK BX	1231350000	C.115
BCF 3.81/05/180LR SN OR BX	1235970000	C.115
BCF 3.81/05/180LR SN BK BX	1972630000	C.113
BCF 3.81/05/180LR SN OR BX	1972230000	C.113
BCF 3.81/05/180LRZE SN BK BX	1231520000	C.115
BCF 3.81/05/180LRZE SN OR BX	1236120000	C.115
BCF 3.81/05/180ZE SN BK BX	1231680000	C.114
BCF 3.81/05/180ZE SN OR BX	1235790000	C.114
BCF 3.81/06/180 SN BK BX	1969980000	C.112
BCF 3.81/06/180 SN OR BX	1969130000	C.112
BCF 3.81/06/180F SN BK BX	1971650000	C.113
BCF 3.81/06/180F SN OR BX	1970400000	C.113
BCF 3.81/06/180LR SN BK BX	1231360000	C.115
BCF 3.81/06/180LR SN OR BX	1235980000	C.115
BCF 3.81/06/180LR SN BK BX	1972640000	C.113
BCF 3.81/06/180LR SN OR BX	1972240000	C.113
BCF 3.81/06/180LRZE SN BK BX	1231530000	C.115
BCF 3.81/06/180LRZE SN OR BX	1236130000	C.115
BCF 3.81/06/180ZE SN BK BX	1231690000	C.114
BCF 3.81/06/180ZE SN OR BX	1235800000	C.114
BCF 3.81/07/180 SN BK BX	1969990000	C.112
BCF 3.81/07/180 SN OR BX	1969140000	C.112
BCF 3.81/07/180F SN BK BX	1971780000	C.113
BCF 3.81/07/180F SN OR BX	1970440000	C.113
BCF 3.81/07/180LR SN BK BX	1231370000	C.115
BCF 3.81/07/180LR SN OR BX	1235990000	C.115

Type	Order No.	Page	Type	Order No.	Page	Type	Order No.	Page
BCZ 3.81/10/90F SN BK BX	1798820000	C.111	BCZ 3.81/15/90 SN OR BX	1939960000	C.110	BL 3.50/02/180 SN OR BX	1597360000	C.44
BCZ 3.81/10/90F SN OR BX	1940060000	C.111	BCZ 3.81/15/90F SN BK BX	1899620000	C.111	BL 3.50/02/180F SN BK BX	1615780000	C.45
BCZ 3.81/11/180 SN BK BX	1899400000	C.106	BCZ 3.81/15/90F SN OR BX	1940100000	C.111	BL 3.50/02/180F SN OR BX	1606640000	C.45
BCZ 3.81/11/180 SN OR BX	1940820000	C.106	BCZ 3.81/16/180 SN BK BX	1792850000	C.106	BL 3.50/02/180LH SN BK BX	1687880000	C.45
BCZ 3.81/11/180F SN BK BX	1899550000	C.107	BCZ 3.81/16/180 SN OR BX	1940870000	C.106	BL 3.50/02/180LH SN OR BX	1687650000	C.45
BCZ 3.81/11/180F SN OR BX	1941100000	C.107	BCZ 3.81/16/180F SN BK BX	1793030000	C.107	BL 3.50/02/180L SN OR BX	1379600000	C.45
BCZ 3.81/11/180FZE SN BK BX	1072180000	C.109	BCZ 3.81/16/180F SN OR BX	1941150000	C.107	BL 3.50/02/270 SN BK BX	1639700000	C.47
BCZ 3.81/11/180FZE SN OR BX	1236620000	C.109	BCZ 3.81/16/180FZE SN BK BX	1072250000	C.109	BL 3.50/02/270 SN OR BX	1639470000	C.47
BCZ 3.81/11/180L SN BK BX	1941870000	C.107	BCZ 3.81/16/180FZE SN OR BX	1236690000	C.109	BL 3.50/02/270F SN BK BX	1640160000	C.47
BCZ 3.81/11/180L SN OR BX	1941490000	C.107	BCZ 3.81/16/180L SN BK BX	1941920000	C.107	BL 3.50/02/270F SN OR BX	1639930000	C.47
BCZ 3.81/11/180LRZE SN BK BX	1072360000	C.109	BCZ 3.81/16/180L SN OR BX	1941540000	C.107	BL 3.50/02/90 SN BK BX	1638780000	C.46
BCZ 3.81/11/180LRZE SN OR BX	1236850000	C.109	BCZ 3.81/16/180LRZE SN BK BX	1072460000	C.109	BL 3.50/02/90 SN OR BX	1638550000	C.46
BCZ 3.81/11/180ZE SN BK BX	1072020000	C.108	BCZ 3.81/16/180LRZE SN OR BX	1236910000	C.109	BL 3.50/02/90F SN BK BX	1639240000	C.47
BCZ 3.81/11/180ZE SN OR BX	1236340000	C.108	BCZ 3.81/16/180ZE SN BK BX	1072070000	C.108	BL 3.50/02/90F SN OR BX	1639010000	C.47
BCZ 3.81/11/270 SN BK BX	1940420000	C.111	BCZ 3.81/16/180ZE SN OR BX	1236410000	C.108	BL 3.50/03/180 SN BK BX	1615680000	C.44
BCZ 3.81/11/270 SN OR BX	1940280000	C.111	BCZ 3.81/16/270 SN BK BX	1799000000	C.111	BL 3.50/03/180 SN OR BX	1597370000	C.44
BCZ 3.81/11/270F SN BK BX	1940690000	C.111	BCZ 3.81/16/270 SN OR BX	1940330000	C.111	BL 3.50/03/180F SN BK BX	1615790000	C.45
BCZ 3.81/11/270F SN OR BX	1940550000	C.111	BCZ 3.81/16/270F SN BK BX	1799160000	C.111	BL 3.50/03/180F SN OR BX	1606650000	C.45
BCZ 3.81/11/90 SN BK BX	1899380000	C.110	BCZ 3.81/16/270F SN OR BX	1940600000	C.111	BL 3.50/03/180LH SN BK BX	1687890000	C.45
BCZ 3.81/11/90 SN OR BX	1939920000	C.110	BCZ 3.81/16/90 SN BK BX	1798660000	C.110	BL 3.50/03/180LH SN OR BX	1687660000	C.45
BCZ 3.81/11/90F SN BK BX	1899560000	C.111	BCZ 3.81/16/90 SN OR BX	1939970000	C.110	BL 3.50/03/180L SN OR BX	1134310000	C.45
BCZ 3.81/11/90F SN OR BX	1940070000	C.111	BCZ 3.81/16/90F SN BK BX	1798840000	C.111	BL 3.50/03/270 SN BK BX	1639710000	C.47
BCZ 3.81/12/180 SN BK BX	1798240000	C.106	BCZ 3.81/16/90F SN OR BX	1940120000	C.111	BL 3.50/03/270 SN OR BX	1639480000	C.47
BCZ 3.81/12/180 SN OR BX	1940830000	C.106	BCZ 3.81/17/180 SN BK BX	1940970000	C.106	BL 3.50/03/270F SN BK BX	1640170000	C.47
BCZ 3.81/12/180F SN BK BX	1793020000	C.107	BCZ 3.81/17/180 SN OR BX	1940890000	C.106	BL 3.50/03/270F SN OR BX	1639940000	C.47
BCZ 3.81/12/180F SN OR BX	1941110000	C.107	BCZ 3.81/17/180F SN BK BX	1941360000	C.107	BL 3.50/03/90 SN BK BX	1638790000	C.46
BCZ 3.81/12/180FZE SN BK BX	1072190000	C.109	BCZ 3.81/17/180F SN OR BX	1941160000	C.107	BL 3.50/03/90F SN OR BX	1638560000	C.46
BCZ 3.81/12/180FZE SN OR BX	1236630000	C.109	BCZ 3.81/17/180FZE SN BK BX	1072260000	C.109	BL 3.50/03/90F SN BK BX	1639250000	C.47
BCZ 3.81/12/180L SN BK BX	1941880000	C.107	BCZ 3.81/17/180FZE SN OR BX	1236700000	C.109	BL 3.50/03/90F SN OR BX	1639020000	C.47
BCZ 3.81/12/180L SN OR BX	1941500000	C.107	BCZ 3.81/17/180L SN BK BX	1941930000	C.107	BL 3.50/04/180 SN BK BX	1615690000	C.44
BCZ 3.81/12/180LRZE SN BK BX	1072370000	C.109	BCZ 3.81/17/180L SN OR BX	1941560000	C.107	BL 3.50/04/180 SN OR BX	1597380000	C.44
BCZ 3.81/12/180LRZE SN OR BX	1236870000	C.109	BCZ 3.81/17/180LRZE SN BK BX	1072470000	C.109	BL 3.50/04/180F SN BK BX	1615600000	C.45
BCZ 3.81/12/180ZE SN BK BX	1072030000	C.108	BCZ 3.81/17/180LRZE SN OR BX	1236920000	C.109	BL 3.50/04/180F SN OR BX	1606660000	C.45
BCZ 3.81/12/180ZE SN OR BX	1236370000	C.108	BCZ 3.81/17/180ZE SN BK BX	1072080000	C.108	BL 3.50/04/180LH SN BK BX	1687900000	C.45
BCZ 3.81/12/270 SN BK BX	1798990000	C.111	BCZ 3.81/17/180ZE SN OR BX	1236420000	C.108	BL 3.50/04/180LH SN OR BX	1687670000	C.45
BCZ 3.81/12/270 SN OR BX	1940290000	C.111	BCZ 3.81/18/180 SN BK BX	1940980000	C.106	BL 3.50/04/180L SN OR BX	1134320000	C.45
BCZ 3.81/12/270F SN BK BX	1799150000	C.111	BCZ 3.81/18/180 SN OR BX	1940900000	C.106	BL 3.50/04/270 SN BK BX	1639720000	C.47
BCZ 3.81/12/270F SN OR BX	1940560000	C.111	BCZ 3.81/18/180F SN BK BX	1941370000	C.107	BL 3.50/04/270 SN OR BX	1639490000	C.47
BCZ 3.81/12/90 SN BK BX	1798630000	C.110	BCZ 3.81/18/180F SN OR BX	1941170000	C.107	BL 3.50/04/270F SN BK BX	1640180000	C.47
BCZ 3.81/12/90 SN OR BX	1939930000	C.110	BCZ 3.81/18/180FZE SN BK BX	1072270000	C.109	BL 3.50/04/270F SN OR BX	1639950000	C.47
BCZ 3.81/12/90F SN BK BX	1798830000	C.111	BCZ 3.81/18/180FZE SN OR BX	1236720000	C.109	BL 3.50/04/90 SN BK BX	1638800000	C.46
BCZ 3.81/12/90F SN OR BX	1940080000	C.111	BCZ 3.81/18/180L SN BK BX	1941940000	C.107	BL 3.50/04/90 SN OR BX	1638570000	C.46
BCZ 3.81/13/180 SN BK BX	1899440000	C.106	BCZ 3.81/18/180L SN OR BX	1941560000	C.107	BL 3.50/04/90F SN BK BX	1639260000	C.47
BCZ 3.81/13/180 SN OR BX	1940840000	C.106	BCZ 3.81/18/180LRZE SN BK BX	1072480000	C.109	BL 3.50/04/90F SN OR BX	1639030000	C.47
BCZ 3.81/13/180F SN BK BX	1899570000	C.107	BCZ 3.81/18/180LRZE SN OR BX	1236930000	C.109	BL 3.50/05/180 SN BK BX	1614090000	C.44
BCZ 3.81/13/180F SN OR BX	1941120000	C.107	BCZ 3.81/18/180ZE SN BK BX	1072090000	C.108	BL 3.50/05/180 SN OR BX	1597390000	C.44
BCZ 3.81/13/180FZE SN BK BX	1072220000	C.109	BCZ 3.81/18/180ZE SN OR BX	1236430000	C.108	BL 3.50/05/180F SN BK BX	1615810000	C.45
BCZ 3.81/13/180FZE SN OR BX	1236640000	C.109	BCZ 3.81/19/180 SN BK BX	1940990000	C.106	BL 3.50/05/180F SN OR BX	1606670000	C.45
BCZ 3.81/13/180L SN BK BX	1941890000	C.107	BCZ 3.81/19/180 SN OR BX	1940910000	C.106	BL 3.50/05/180LH SN BK BX	1687910000	C.45
BCZ 3.81/13/180L SN OR BX	1941510000	C.107	BCZ 3.81/19/180F SN BK BX	1941380000	C.107	BL 3.50/05/180LH SN OR BX	1687680000	C.45
BCZ 3.81/13/180LRZE SN BK BX	1072380000	C.109	BCZ 3.81/19/180F SN OR BX	1941180000	C.107	BL 3.50/05/180L SN OR BX	1134330000	C.45
BCZ 3.81/13/180LRZE SN OR BX	1236880000	C.109	BCZ 3.81/19/180FZE SN BK BX	1072280000	C.109	BL 3.50/05/270 SN BK BX	1639730000	C.47
BCZ 3.81/13/180ZE SN BK BX	1072040000	C.108	BCZ 3.81/19/180FZE SN OR BX	1236730000	C.109	BL 3.50/05/270 SN OR BX	1639500000	C.47
BCZ 3.81/13/180ZE SN OR BX	1236380000	C.108	BCZ 3.81/19/180L SN BK BX	1941950000	C.107	BL 3.50/05/270F SN BK BX	1640190000	C.47
BCZ 3.81/13/270 SN BK BX	1940430000	C.111	BCZ 3.81/19/180L SN OR BX	1941570000	C.107	BL 3.50/05/270F SN OR BX	1639960000	C.47
BCZ 3.81/13/270 SN OR BX	1940300000	C.111	BCZ 3.81/19/180LRZE SN BK BX	1072490000	C.109	BL 3.50/05/90 SN BK BX	1638810000	C.46
BCZ 3.81/13/270F SN BK BX	1940700000	C.111	BCZ 3.81/19/180LRZE SN OR BX	1236940000	C.109	BL 3.50/05/90 SN OR BX	1638580000	C.46
BCZ 3.81/13/270F SN OR BX	1940570000	C.111	BCZ 3.81/19/180ZE SN BK BX	1072110000	C.108	BL 3.50/05/90F SN BK BX	1639270000	C.47
BCZ 3.81/13/90 SN BK BX	1899420000	C.110	BCZ 3.81/19/180ZE SN OR BX	1236440000	C.108	BL 3.50/05/90F SN OR BX	1639040000	C.47
BCZ 3.81/13/90 SN OR BX	1939940000	C.110	BCZ 3.81/20/180 SN BK BX	1941000000	C.106	BL 3.50/06/180 SN BK BX	1610180000	C.44
BCZ 3.81/13/90F SN BK BX	1899580000	C.111	BCZ 3.81/20/180 SN OR BX	1940920000	C.106	BL 3.50/06/180 SN OR BX	1597400000	C.44
BCZ 3.81/13/90F SN OR BX	1940090000	C.111	BCZ 3.81/20/180F SN BK BX	1941390000	C.107	BL 3.50/06/180F SN BK BX	1615820000	C.45
BCZ 3.81/14/180 SN BK BX	1899480000	C.106	BCZ 3.81/20/180F SN OR BX	1941190000	C.107	BL 3.50/06/180F SN OR BX	1606680000	C.45
BCZ 3.81/14/180 SN OR BX	1940850000	C.106	BCZ 3.81/20/180FZE SN BK BX	1072290000	C.109	BL 3.50/06/180LH SN BK BX	1687920000	C.45
BCZ 3.81/14/180F SN BK BX	1899590000	C.107	BCZ 3.81/20/180FZE SN OR BX	1236740000	C.109	BL 3.50/06/180LH SN OR BX	1687690000	C.45
BCZ 3.81/14/180F SN OR BX	1941130000	C.107	BCZ 3.81/20/180L SN BK BX	1941960000	C.107	BL 3.50/06/180L SN OR BX	1134340000	C.45
BCZ 3.81/14/180FZE SN BK BX	1072230000	C.109	BCZ 3.81/20/180L SN OR BX	1941580000	C.107	BL 3.50/06/270 SN BK BX	1639740000	C.47
BCZ 3.81/14/180FZE SN OR BX	1236670000	C.109	BCZ 3.81/20/180LRZE SN BK BX	1072510000	C.109	BL 3.50/06/270 SN OR BX	1639510000	C.47
BCZ 3.81/14/180L SN BK BX	1941900000	C.107	BCZ 3.81/20/180LRZE SN OR BX	1236950000	C.109	BL 3.50/06/270F SN BK BX	1640200000	C.47
BCZ 3.81/14/180L SN OR BX	1941520000	C.107	BCZ 3.81/20/180ZE SN BK BX	1072120000	C.108	BL 3.50/06/270F SN OR BX	1639970000	C.47
BCZ 3.81/14/180LRZE SN BK BX	1072390000	C.109	BCZ 3.81/20/180ZE SN OR BX	1236470000	C.108	BL 3.50/06/90 SN BK BX	1638820000	C.46
BCZ 3.81/14/180LRZE SN OR BX	1236890000	C.109	BHZ 5.00/02/90LH BK/BK	1069330000	I.19	BL 3.50/06/90 SN OR BX	1638590000	C.46
BCZ 3.81/14/180ZE SN BK BX	1072050000	C.108	BHZ 5.00/02/90LH BK/BL	1069360000	I.19	BL 3.50/06/90F SN BK BX	1639280000	C.47
BCZ 3.81/14/180ZE SN OR BX	1236390000	C.108	BHZ 5.00/02/90LH BK/OR	1063260000	I.19	BL 3.50/06/90F SN OR BX	1639050000	C.47
BCZ 3.81/14/270 SN BK BX	1940440000	C.111	BHZ 5.00/03/90LH BK/BK	1069340000	I.21	BL 3.50/07/180 SN BK BX	1610190000	C.44
BCZ 3.81/14/270 SN OR BX	1940310000	C.111	BHZ 5.00/03/90LH BK/BL	1069370000	I.21	BL 3.50/07/180 SN OR BX	1597410000	C.44
BCZ 3.81/14/270F SN BK BX	1940710000	C.111	BHZ 5.00/03/90LH BK/OR	1063270000	I.21	BL 3.50/07/180F SN BK BX	1615830000	C.45
BCZ 3.81/14/270F SN OR BX	1940580000	C.111	BHZ 5.00/04/90LH BK/BK	1069350000	I.23	BL 3.50/07/180F SN OR BX	1606690000	C.45
BCZ 3.81/14/90 SN BK BX	1899460000	C.110	BHZ 5.00/04/90LH BK/BL	1069380000	I.23	BL 3.50/07/180LH SN BK BX	1687930000	C.45
BCZ 3.81/14/90 SN OR BX	1939950000	C.110	BHZ 5.00/04/90LH BK/OR	1063280000	I.23	BL 3.50/07/180LH SN OR BX	1687700000	C.45
BCZ 3.81/14/90F SN BK BX	1899600000	C.111	BL 3.5 AH 10 SW	1745650000	D.4	BL 3.50/07/180L SN OR BX	1134350000	C.45
BCZ 3.81/14/90F SN OR BX	1940100000	C.111	BL 3.5 AH 11 SW	1745660000	D.4	BL 3.50/07/270 SN BK BX	1639750000	C.47
BCZ 3.81/15/180 SN BK BX	1899520000	C.106	BL 3.5 AH 12 SW	1745670000	D.4	BL 3.50/07/270 SN OR BX	1639520000	C.47
BCZ 3.81/15/180 SN OR BX	1940860000	C.106	BL 3.5 AH 13 SW	1745680000	D.4	BL 3.50/07/270F SN BK BX	1640210000	C.47
BCZ 3.81/15/180F SN BK BX	1899610000	C.107	BL 3.5 AH 14 SW	1745690000	D.4	BL 3.50/07/270F SN OR BX	1639980000	C.47
BCZ 3.81/15/180F SN OR BX	1941140000	C.107	BL 3.5 AH 15 SW	1745700000	D.4	BL 3.50/07/90 SN BK BX	1638830000	C.46
BC								

Type	Order No.	Page
LSF-SMT 7.50/02/90 3.5SN BK RL	1875470000	B.85
LSF-SMT 7.50/02/90 3.5SN BK TU	1824880000	B.84
LSF-SMT 7.50/03/135 1.5SN BK RL	1888910000	B.87
LSF-SMT 7.50/03/135 1.5SN BK TU	1884890000	B.86
LSF-SMT 7.50/03/135 3.5SN BK RL	1888990000	B.87
LSF-SMT 7.50/03/135 3.5SN BK TU	1886120000	B.86
LSF-SMT 7.50/03/180 1.5SN BK RL	1875460000	B.89
LSF-SMT 7.50/03/180 1.5SN BK TU	1870290000	B.88
LSF-SMT 7.50/03/180 3.5SN BK RL	1875450000	B.89
LSF-SMT 7.50/03/180 3.5SN BK TU	1826140000	B.88
LSF-SMT 7.50/03/90 1.5SN BK RL	1875440000	B.85
LSF-SMT 7.50/03/90 1.5SN BK TU	1869750000	B.84
LSF-SMT 7.50/03/90 3.5SN BK RL	1875430000	B.85
LSF-SMT 7.50/03/90 3.5SN BK TU	1824890000	B.84
LSF-SMT 7.50/04/135 1.5SN BK RL	1888930000	B.87
LSF-SMT 7.50/04/135 1.5SN BK TU	1884900000	B.86
LSF-SMT 7.50/04/135 3.5SN BK RL	1889000000	B.87
LSF-SMT 7.50/04/135 3.5SN BK TU	1886130000	B.86
LSF-SMT 7.50/04/180 1.5SN BK RL	1875090000	B.89
LSF-SMT 7.50/04/180 1.5SN BK TU	1870300000	B.88
LSF-SMT 7.50/04/180 3.5SN BK RL	1875060000	B.89
LSF-SMT 7.50/04/180 3.5SN BK TU	1826150000	B.88
LSF-SMT 7.50/04/90 1.5SN BK RL	1875040000	B.85
LSF-SMT 7.50/04/90 1.5SN BK TU	1869760000	B.84
LSF-SMT 7.50/04/90 3.5SN BK RL	1875020000	B.85
LSF-SMT 7.50/04/90 3.5SN BK TU	1824900000	B.84
LSF-SMT 7.50/05/135 1.5SN BK RL	1888940000	B.87
LSF-SMT 7.50/05/135 1.5SN BK TU	1884910000	B.86
LSF-SMT 7.50/05/135 3.5SN BK RL	1889020000	B.87
LSF-SMT 7.50/05/135 3.5SN BK TU	1886140000	B.86
LSF-SMT 7.50/05/180 1.5SN BK RL	1875010000	B.89
LSF-SMT 7.50/05/180 1.5SN BK TU	1870310000	B.88
LSF-SMT 7.50/05/180 3.5SN BK RL	1875000000	B.89
LSF-SMT 7.50/05/180 3.5SN BK TU	1826160000	B.88
LSF-SMT 7.50/05/90 1.5SN BK RL	1874980000	B.85
LSF-SMT 7.50/05/90 1.5SN BK TU	1869770000	B.84
LSF-SMT 7.50/05/90 3.5SN BK RL	1874960000	B.85
LSF-SMT 7.50/05/90 3.5SN BK TU	1824910000	B.84
LSF-SMT 7.50/06/135 1.5SN BK RL	1888950000	B.87
LSF-SMT 7.50/06/135 1.5SN BK TU	1884920000	B.86
LSF-SMT 7.50/06/135 3.5SN BK RL	1889030000	B.87
LSF-SMT 7.50/06/135 3.5SN BK TU	1886150000	B.86
LSF-SMT 7.50/06/180 1.5SN BK RL	1874950000	B.89
LSF-SMT 7.50/06/180 1.5SN BK TU	1870320000	B.88
LSF-SMT 7.50/06/180 3.5SN BK RL	1874920000	B.89
LSF-SMT 7.50/06/180 3.5SN BK TU	1826170000	B.88
LSF-SMT 7.50/06/90 1.5SN BK RL	1874910000	B.85
LSF-SMT 7.50/06/90 1.5SN BK TU	1869780000	B.84
LSF-SMT 7.50/06/90 3.5SN BK RL	1874880000	B.85
LSF-SMT 7.50/06/90 3.5SN BK TU	1824920000	B.84
LSF-SMT 7.50/07/135 1.5SN BK TU	1884930000	B.86
LSF-SMT 7.50/07/135 3.5SN BK TU	1886160000	B.86
LSF-SMT 7.50/07/180 1.5SN BK TU	1870330000	B.88
LSF-SMT 7.50/07/180 3.5SN BK TU	1826180000	B.88
LSF-SMT 7.50/07/90 1.5SN BK TU	1874870000	B.84
LSF-SMT 7.50/07/90 3.5SN BK TU	1824930000	B.84
LSF-SMT 7.50/08/135 1.5SN BK TU	1884940000	B.86
LSF-SMT 7.50/08/135 3.5SN BK TU	1886170000	B.86
LSF-SMT 7.50/08/180 1.5SN BK TU	1870340000	B.88
LSF-SMT 7.50/08/180 3.5SN BK TU	1826190000	B.88
LSF-SMT 7.50/08/90 1.5SN BK TU	1874860000	B.84
LSF-SMT 7.50/08/90 3.5SN BK TU	1824940000	B.84
LSF-SMT 7.62/02/135 1.5SN BK RL	1887110000	B.93
LSF-SMT 7.62/02/135 1.5SN BK TU	1884950000	B.92
LSF-SMT 7.62/02/135 3.5SN BK RL	1887160000	B.93
LSF-SMT 7.62/02/135 3.5SN BK TU	1886180000	B.92
LSF-SMT 7.62/02/180 1.5SN BK RL	1874870000	B.95
LSF-SMT 7.62/02/180 1.5SN BK TU	1889810000	B.94
LSF-SMT 7.62/02/180 3.5SN BK RL	1874750000	B.95
LSF-SMT 7.62/02/180 3.5SN BK TU	1826210000	B.94
LSF-SMT 7.62/02/90 1.5SN BK RL	1874700000	B.91
LSF-SMT 7.62/02/90 1.5SN BK TU	1869260000	B.90
LSF-SMT 7.62/02/90 3.5SN BK RL	1874670000	B.91
LSF-SMT 7.62/02/90 3.5SN BK TU	1824950000	B.90
LSF-SMT 7.62/03/135 1.5SN BK RL	1887120000	B.93
LSF-SMT 7.62/03/135 1.5SN BK TU	1884960000	B.92
LSF-SMT 7.62/03/135 3.5SN BK RL	1887170000	B.93
LSF-SMT 7.62/03/135 3.5SN BK TU	1886190000	B.92
LSF-SMT 7.62/03/180 1.5SN BK RL	1874650000	B.95
LSF-SMT 7.62/03/180 1.5SN BK TU	1869830000	B.94
LSF-SMT 7.62/03/180 3.5SN BK RL	1874630000	B.95
LSF-SMT 7.62/03/180 3.5SN BK TU	1826220000	B.94
LSF-SMT 7.62/03/90 1.5SN BK RL	1874570000	B.91
LSF-SMT 7.62/03/90 1.5SN BK TU	1869270000	B.90
LSF-SMT 7.62/03/90 3.5SN BK RL	1874550000	B.91
LSF-SMT 7.62/03/90 3.5SN BK TU	1824960000	B.90
LSF-SMT 7.62/04/135 1.5SN BK RL	1887130000	B.93
LSF-SMT 7.62/04/135 1.5SN BK TU	1884970000	B.92
LSF-SMT 7.62/04/135 3.5SN BK RL	1887180000	B.93
LSF-SMT 7.62/04/135 3.5SN BK TU	1886200000	B.92
LSF-SMT 7.62/04/180 1.5SN BK RL	1874530000	B.95
LSF-SMT 7.62/04/180 1.5SN BK TU	1869840000	B.94
LSF-SMT 7.62/04/180 3.5SN BK RL	1874510000	B.95
LSF-SMT 7.62/04/180 3.5SN BK TU	1826230000	B.94
LSF-SMT 7.62/04/90 1.5SN BK RL	1874480000	B.91
LSF-SMT 7.62/04/90 1.5SN BK TU	1869280000	B.90
LSF-SMT 7.62/04/90 3.5SN BK RL	1874460000	B.91
LSF-SMT 7.62/04/90 3.5SN BK TU	1824970000	B.90
LSF-SMT 7.62/05/135 1.5SN BK RL	1887140000	B.93

Type	Order No.	Page
LSF-SMT 7.62/05/135 1.5SN BK TU	1884980000	B.92
LSF-SMT 7.62/05/135 3.5SN BK RL	1887190000	B.93
LSF-SMT 7.62/05/135 3.5SN BK TU	1886210000	B.92
LSF-SMT 7.62/05/180 1.5SN BK RL	1874450000	B.95
LSF-SMT 7.62/05/180 1.5SN BK TU	1869850000	B.94
LSF-SMT 7.62/05/180 3.5SN BK RL	1874460000	B.95
LSF-SMT 7.62/05/180 3.5SN BK TU	1826240000	B.94
LSF-SMT 7.62/05/90 1.5SN BK RL	1874430000	B.91
LSF-SMT 7.62/05/90 1.5SN BK TU	1869290000	B.90
LSF-SMT 7.62/05/90 3.5SN BK RL	1874410000	B.91
LSF-SMT 7.62/05/90 3.5SN BK TU	1824980000	B.90
LSF-SMT 7.62/06/135 1.5SN BK RL	1887150000	B.93
LSF-SMT 7.62/06/135 1.5SN BK TU	1884990000	B.92
LSF-SMT 7.62/06/135 3.5SN BK RL	1887200000	B.93
LSF-SMT 7.62/06/135 3.5SN BK TU	1886220000	B.92
LSF-SMT 7.62/06/180 1.5SN BK RL	1874390000	B.95
LSF-SMT 7.62/06/180 1.5SN BK TU	1869860000	B.94
LSF-SMT 7.62/06/180 3.5SN BK RL	1874360000	B.95
LSF-SMT 7.62/06/180 3.5SN BK TU	1826250000	B.94
LSF-SMT 7.62/06/90 1.5SN BK RL	1874330000	B.91
LSF-SMT 7.62/06/90 1.5SN BK TU	1869300000	B.90
LSF-SMT 7.62/06/90 3.5SN BK RL	1874290000	B.91
LSF-SMT 7.62/06/90 3.5SN BK TU	1824990000	B.90
LSF-SMT 7.62/07/135 1.5SN BK TU	1885000000	B.92
LSF-SMT 7.62/07/135 3.5SN BK TU	1886230000	B.92
LSF-SMT 7.62/07/180 1.5SN BK TU	1869870000	B.94
LSF-SMT 7.62/07/180 3.5SN BK TU	1826260000	B.94
LSF-SMT 7.62/07/90 1.5SN BK TU	1869310000	B.90
LSF-SMT 7.62/07/90 3.5SN BK TU	1825000000	B.90
LSF-SMT 7.62/08/135 1.5SN BK TU	1885010000	B.92
LSF-SMT 7.62/08/135 3.5SN BK TU	1886240000	B.92
LSF-SMT 7.62/08/180 1.5SN BK TU	1869880000	B.94
LSF-SMT 7.62/08/180 3.5SN BK TU	1826270000	B.94
LSF-SMT 7.62/08/90 1.5SN BK TU	1869320000	B.90
LSF-SMT 7.62/08/90 3.5SN BK TU	1825010000	B.90
LU 10.16/02/90 4.5SN BK BX	1934140000	E.6
LU 10.16/03/90 4.5SN BK BX	1921450000	E.6
LU 10.16/04/90 4.5SN BK BX	1226220000	E.6
LU 10.16/05/90 4.5SN BK BX	1226230000	E.6
LU 10.16/06/90 4.5SN BK BX	1226240000	E.6
LU 10.16/07/90 4.5SN BK BX	1226250000	E.6
LU 10.16/08/90 4.5SN BK BX	1226260000	E.6
LU 10.16/09/90 4.5SN BK BX	1226270000	E.6
LU 10.16/10/90 4.5SN BK BX	1226280000	E.6
LWP 10.16/02/90 3.2SN BK BX	1226290000	E.7
LWP 10.16/02/90 3.2SN BK BX	1192980000	E.8
LWP 10.16/03/90 3.2SN BK BX	1226300000	E.7
LWP 10.16/03/90 3.2SN BK BX	1192990000	E.8
LWP 10.16/04/90 3.2SN BK BX	1226310000	E.7
LWP 10.16/04/90 3.2SN BK BX	1193000000	E.8
LWP 10.16/05/90 3.2SN BK BX	1226320000	E.7
LWP 10.16/05/90 3.2SN BK BX	1193010000	E.8
LWP 10.16/06/90 3.2SN BK BX	1226330000	E.7
LWP 10.16/06/90 3.2SN BK BX	1193020000	E.8
LWP 10.16/07/90 3.2SN BK BX	1226340000	E.7
LWP 10.16/07/90 3.2SN BK BX	1193030000	E.8
LWP 10.16/08/90 3.2SN BK BX	1226350000	E.7
LWP 10.16/08/90 3.2SN BK BX	1193040000	E.8
LWP 10.16/09/90 3.2SN BK BX	1226360000	E.7
LWP 10.16/09/90 3.2SN BK BX	1193050000	E.8
LWP 12.70/02/90 3.2SN BK BX	1226370000	E.9
LWP 12.70/03/90 3.2SN BK BX	1226380000	E.9
LWP 12.70/04/90 3.2SN BK BX	1226390000	E.9
LWP 12.70/05/90 3.2SN BK BX	1226410000	E.9
LWP 12.70/06/90 3.2SN BK BX	1226420000	E.9
LWP 12.70/07/90 3.2SN BK BX	1226430000	E.9
LWP 12.70/08/90 3.2SN BK BX	1226440000	E.9
LWP 12.70/09/90 3.2SN BK BX	1226450000	E.9
LX 15.00/01/90 4.5SN BK BX	1226460000	E.10
LX 15.00/02/90 4.5SN BK BX	1226470000	E.10
LX 15.00/03/90 4.5SN BK BX	1174720000	E.10
LX 15.00/04/90 4.5SN BK BX	1226480000	E.10
LX 15.00/05/90 4.5SN BK BX	1226490000	E.10
LX 15.00/06/90 4.5SN BK BX	1226500000	E.10
LX 15.00/07/90 4.5SN BK BX	1226510000	E.10
LX 15.00/08/90 4.5SN BK BX	1921480000	E.10
LXB 15.00/02/90 4.5SN BK BX	1226520000	E.11
LXB 15.00/03/90 4.5SN BK BX	1226530000	E.11
LXB 15.00/04/90 4.5SN BK BX	1226540000	E.11
LXB 15.00/05/90 4.5SN BK BX	1226550000	E.11
LXB 15.00/06/90 4.5SN BK BX	1226560000	E.11
LXB 15.00/07/90 4.5SN BK BX	1226570000	E.11
LXB 15.00/08/90 4.5SN BK BX	1226580000	E.11
LXBL 15.00/01/90 4.5SN BK BX	1226590000	E.11
LXXX 15.00/01/90 4.5SN BK BX	1047120000	E.12
LXXX 15.00/01/90F 4.5SN BK BX	1047280000	E.13
LXXX 15.00/01/90FL 4.5SN BK BX	1047440000	E.13
LXXX 15.00/01/90FR 4.5SN BK BX	1047600000	E.13
LXXX 15.00/02/90 4.5SN BK BX	1047130000	E.12
LXXX 15.00/02/90F 4.5SN BK BX	1047290000	E.13
LXXX 15.00/02/90FL 4.5SN BK BX	1047450000	E.13
LXXX 15.00/02/90FR 4.5SN BK BX	1047610000	E.13
LXXX 15.00/03/90 4.5SN BK BX	1047140000	E.12
LXXX 15.00/03/90F 4.5SN BK BX	1047300000	E.13
LXXX 15.00/03/90FL 4.5SN BK BX	1047460000	E.13
LXXX 15.00/03/90FR 4.5SN BK BX	1047620000	E.13
LXXX 15.00/04/90 4.5SN BK BX	1047150000	E.12
LXXX 15.00/04/90F 4.5SN BK BX	1047310000	E.13
LXXX 15.00/04/90FL 4.5SN BK BX	1047470000	E.13

Type	Order No.	Page
LXXX 15.00/04/90FR 4.5SN BK BX	1047630000	E.13
M		
MCZ 5	8857560000	I.39
MF 5/7.5 MC NEUTRAL	1877680000	I.17
MHS 6	1925740000	I.38
MHZ 6	1925760000	I.38
MOFU 35/10/1 SW	0646210000	J.2
MTA 30 BK	1168970000	J.2
MTA 45 BK	1962250000	J.2
P		
PF RS 100 GR 2000MM A.1	4010870000	I.48
PF RS 100 OR 155 MM	4148400000	I.48
PF RS 100 OR 2000MM A.1	4144870000	I.48
PF RS 122 OR 2000MM	1155940000	I.49
PF RS 45 GR 1000MM	8140880000	I.44
PF RS 45 GR 2000MM	4027750000	I.44
PF RS 45 OR 2000MM	4340430000	I.44
PF RS 80 GR 2000MM	4183130000	I.46
PF RS 80 OR 2000MM	4157440000	I.46
PF RS 90 GR 2000MM	4051810000	I.47
PF RS 90 OR 2000MM	4053240000	I.47
PM 5.00/02/90 3.5SN OR BX	1791610000	B.56
PM 5.00/03/90 3.5SN OR BX	1791620000	B.56
PM 5.00/04/90 3.5SN OR BX	1234650000	B.56
PM 5.00/05/90 3.5SN OR BX	1234670000	B.56
PM 5.00/06/90 3.5SN OR BX	1234680000	B.56
PM 5.00/07/90 3.5SN OR BX	1234690000	B.56
PM 5.00/08/90 3.5SN OR BX	1234700000	B.56
PM 5.00/09/90 3.5SN OR BX	1234710000	B.56
PM 5.00/10/90 3.5SN OR BX	1234720000	

Table with 3 columns: Type, Order No., Page. Lists part types from SC 3.81/12/180F 3.2SN BK BX to SC 3.81/19/90G 3.2SN OR BX.

Table with 3 columns: Type, Order No., Page. Lists part types from SC 3.81/20/180F 3.2SN BK BX to SC 3.81/05/90G 1.5SN BK BX.

Table with 3 columns: Type, Order No., Page. Lists part types from SC-SMT 3.81/05/90G 3.2SN BK BX to SC-SMT 3.81/10/135G 1.5SN BK BX.

Type	Order No.	Page	Type	Order No.	Page	Type	Order No.	Page
SC-SMT 3.81/10/135G 3.2SN BK BX	1977710000	C.70	SC-SMT 3.81/16/135G 1.5SN BK BX	1978070000	C.70	SCD 3.81/24/180G 3.2SN OR BX	1030040000	C.94
SC-SMT 3.81/10/135LF 1.5 SN BK BX	1978460000	C.71	SC-SMT 3.81/16/135G 3.2SN BK BX	1977770000	C.70	SCD 3.81/24/90F 3.2SN BK BX	1973680000	C.93
SC-SMT 3.81/10/135LF 3.2 SN BK BX	1978160000	C.71	SC-SMT 3.81/16/135LF 1.5 SN BK BX	1978520000	C.71	SCD 3.81/24/90F 3.2SN OR BX	1973360000	C.93
SC-SMT 3.81/10/180G 1.5SN BK BX	1863920000	C.68	SC-SMT 3.81/16/135LF 3.2 SN BK BX	1978220000	C.71	SCD 3.81/24/90G 3.2SN BK BX	1973210000	C.92
SC-SMT 3.81/10/180G 1.5SN BK RL	1864350000	C.69	SC-SMT 3.81/16/180G 1.5SN BK BX	1864040000	C.68	SCD 3.81/24/90G 3.2SN OR BX	1972890000	C.92
SC-SMT 3.81/10/180G 3.2SN BK BX	1863290000	C.68	SC-SMT 3.81/16/180G 3.2SN BK BX	1863420000	C.68	SCD 3.81/26/180F 3.2SN BK BX	1030910000	C.95
SC-SMT 3.81/10/180G 3.2SN BK RL	1863660000	C.69	SC-SMT 3.81/16/180LF 1.5SN BK BX	1864210000	C.69	SCD 3.81/26/180F 3.2SN OR BX	1030560000	C.95
SC-SMT 3.81/10/180LF 1.5SN BK BX	1864150000	C.69	SC-SMT 3.81/16/180LF 3.2SN BK BX	1863480000	C.69	SCD 3.81/26/180G 3.2SN BK BX	1030390000	C.94
SC-SMT 3.81/10/180LF 3.2SN BK BX	1863380000	C.69	SC-SMT 3.81/16/270F 1.5SN BK BX	1037480000	C.73	SCD 3.81/26/180G 3.2SN OR BX	1030050000	C.94
SC-SMT 3.81/10/270F 1.5SN BK BX	1037410000	C.73	SC-SMT 3.81/16/270F 3.2SN BK BX	1037150000	C.73	SCD 3.81/26/90F 3.2SN BK BX	1973690000	C.93
SC-SMT 3.81/10/270F 3.2SN BK BX	1037080000	C.73	SC-SMT 3.81/16/270G 1.5SN BK BX	1036980000	C.72	SCD 3.81/26/90F 3.2SN OR BX	1973370000	C.93
SC-SMT 3.81/10/270G 1.5SN BK BX	1036920000	C.72	SC-SMT 3.81/16/270G 3.2SN BK BX	1036640000	C.72	SCD 3.81/26/90G 3.2SN BK BX	1973220000	C.92
SC-SMT 3.81/10/270G 3.2SN BK BX	1036570000	C.72	SC-SMT 3.81/16/90G 1.5SN BK BX	1863130000	C.66	SCD 3.81/26/90G 3.2SN OR BX	1972900000	C.92
SC-SMT 3.81/10/90G 1.5SN BK BX	1863070000	C.66	SC-SMT 3.81/16/90G 3.2SN BK BX	1862800000	C.66	SCD 3.81/26/90F 3.2SN BK BX	1030920000	C.95
SC-SMT 3.81/10/90G 1.5SN BK RL	1863220000	C.67	SC-SMT 3.81/16/90LF 1.5SN BK BX	1862710000	C.67	SCD 3.81/28/180F 3.2SN OR BX	1030570000	C.95
SC-SMT 3.81/10/90G 3.2SN BK BX	1862550000	C.66	SC-SMT 3.81/16/90LF 3.2SN BK BX	1863870000	C.67	SCD 3.81/28/180G 3.2SN BK BX	1030410000	C.94
SC-SMT 3.81/10/90G 3.2SN BK RL	1862930000	C.67	SCD 3.81/04/180F 3.2SN BK BX	1030780000	C.95	SCD 3.81/28/180G 3.2SN OR BX	1030060000	C.94
SC-SMT 3.81/10/90LF 1.5SN BK BX	1862650000	C.67	SCD 3.81/04/180F 3.2SN OR BX	1030440000	C.95	SCD 3.81/28/90F 3.2SN BK BX	1973700000	C.93
SC-SMT 3.81/10/90LF 3.2SN BK BX	1863790000	C.67	SCD 3.81/04/180G 3.2SN BK BX	1030260000	C.94	SCD 3.81/28/90F 3.2SN OR BX	1973380000	C.93
SC-SMT 3.81/11/135G 1.5SN BK BX	1978020000	C.70	SCD 3.81/04/180G 3.2SN OR BX	1029920000	C.94	SCD 3.81/28/90G 3.2SN BK BX	1973230000	C.92
SC-SMT 3.81/11/135G 3.2SN BK BX	1977720000	C.70	SCD 3.81/04/90F 3.2SN BK BX	1973580000	C.93	SCD 3.81/28/90G 3.2SN OR BX	1972910000	C.92
SC-SMT 3.81/11/135LF 1.5 SN BK BX	1978470000	C.71	SCD 3.81/04/90F 3.2SN OR BX	1973260000	C.93	SCD 3.81/30/180F 3.2SN BK BX	1030930000	C.95
SC-SMT 3.81/11/135LF 3.2 SN BK BX	1978170000	C.71	SCD 3.81/04/90G 3.2SN BK BX	1973100000	C.92	SCD 3.81/30/180F 3.2SN OR BX	1030580000	C.95
SC-SMT 3.81/11/180G 1.5SN BK BX	1863930000	C.68	SCD 3.81/04/90G 3.2SN OR BX	1972790000	C.92	SCD 3.81/30/180G 3.2SN BK BX	1030420000	C.94
SC-SMT 3.81/11/180G 3.2SN BK BX	1863320000	C.68	SCD 3.81/06/180F 3.2SN BK BX	1030790000	C.95	SCD 3.81/30/180G 3.2SN OR BX	1030070000	C.94
SC-SMT 3.81/11/180LF 1.5SN BK BX	1864160000	C.69	SCD 3.81/06/180F 3.2SN OR BX	1030450000	C.95	SCD 3.81/30/90F 3.2SN BK BX	1973710000	C.93
SC-SMT 3.81/11/180LF 3.2SN BK BX	1863390000	C.69	SCD 3.81/06/180G 3.2SN BK BX	1030270000	C.94	SCD 3.81/30/90F 3.2SN OR BX	1973390000	C.93
SC-SMT 3.81/11/270F 1.5SN BK BX	1037420000	C.73	SCD 3.81/06/180G 3.2SN OR BX	1029940000	C.94	SCD 3.81/30/90G 3.2SN BK BX	1973240000	C.92
SC-SMT 3.81/11/270F 3.2SN BK BX	1037090000	C.73	SCD 3.81/06/90F 3.2SN BK BX	1973590000	C.93	SCD 3.81/30/90G 3.2SN OR BX	1972920000	C.92
SC-SMT 3.81/11/270G 1.5SN BK BX	1036930000	C.72	SCD 3.81/06/90F 3.2SN OR BX	1973270000	C.93	SCD 3.81/32/180F 3.2SN BK BX	1030940000	C.95
SC-SMT 3.81/11/270G 3.2SN BK BX	1036580000	C.72	SCD 3.81/06/90G 3.2SN BK BX	1973110000	C.92	SCD 3.81/32/180F 3.2SN OR BX	1030590000	C.95
SC-SMT 3.81/11/90G 1.5SN BK BX	1863080000	C.66	SCD 3.81/06/90G 3.2SN OR BX	1972800000	C.92	SCD 3.81/32/180G 3.2SN BK BX	1030430000	C.94
SC-SMT 3.81/11/90G 3.2SN BK BX	1862570000	C.66	SCD 3.81/08/180F 3.2SN BK BX	1030810000	C.95	SCD 3.81/32/180G 3.2SN OR BX	1030080000	C.94
SC-SMT 3.81/11/90LF 1.5SN BK BX	1862660000	C.67	SCD 3.81/08/180F 3.2SN OR BX	1030460000	C.95	SCD 3.81/32/90F 3.2SN BK BX	1973720000	C.93
SC-SMT 3.81/11/90LF 3.2SN BK BX	1863810000	C.67	SCD 3.81/08/180G 3.2SN BK BX	1030280000	C.94	SCD 3.81/32/90F 3.2SN OR BX	1973400000	C.93
SC-SMT 3.81/12/135G 1.5SN BK BX	1978030000	C.70	SCD 3.81/08/180G 3.2SN OR BX	1029950000	C.94	SCD 3.81/32/90G 3.2SN BK BX	1973250000	C.92
SC-SMT 3.81/12/135G 3.2SN BK BX	1977730000	C.70	SCD 3.81/08/90F 3.2SN BK BX	1973600000	C.93	SCD 3.81/32/90G 3.2SN OR BX	1972930000	C.92
SC-SMT 3.81/12/135LF 1.5 SN BK BX	1978480000	C.71	SCD 3.81/08/90F 3.2SN OR BX	1973280000	C.93	SCD-THR 3.81/04/180F 1.5SN BK BX	1031860000	C.77
SC-SMT 3.81/12/135LF 3.2 SN BK BX	1978180000	C.71	SCD 3.81/08/90G 3.2SN BK BX	1973120000	C.92	SCD-THR 3.81/04/180F 3.2SN BK BX	1031460000	C.77
SC-SMT 3.81/12/180G 1.5SN BK BX	1863940000	C.68	SCD 3.81/08/90G 3.2SN OR BX	1972810000	C.92	SCD-THR 3.81/04/180G 1.5SN BK BX	1031290000	C.76
SC-SMT 3.81/12/180G 3.2SN BK BX	1863330000	C.68	SCD 3.81/10/180F 3.2SN BK BX	1030820000	C.95	SCD-THR 3.81/04/180G 3.2SN BK BX	1030950000	C.76
SC-SMT 3.81/12/180LF 1.5SN BK BX	1864170000	C.69	SCD 3.81/10/180F 3.2SN OR BX	1030470000	C.95	SCD-THR 3.81/04/90F 1.5SN BK BX	1974830000	C.75
SC-SMT 3.81/12/180LF 3.2SN BK BX	1863340000	C.69	SCD 3.81/10/180G 3.2SN BK BX	1030290000	C.94	SCD-THR 3.81/04/90F 3.2SN BK BX	1974180000	C.75
SC-SMT 3.81/12/270F 1.5SN BK BX	1037440000	C.73	SCD 3.81/10/180G 3.2SN OR BX	1029960000	C.94	SCD-THR 3.81/04/90G 1.5SN BK BX	1974030000	C.74
SC-SMT 3.81/12/270F 3.2SN BK BX	1037110000	C.73	SCD 3.81/10/90F 3.2SN BK BX	1973610000	C.93	SCD-THR 3.81/04/90G 3.2SN BK BX	1973730000	C.74
SC-SMT 3.81/12/270G 1.5SN BK BX	1036940000	C.72	SCD 3.81/10/90F 3.2SN OR BX	1973290000	C.93	SCD-THR 3.81/06/180F 1.5SN BK BX	1031870000	C.77
SC-SMT 3.81/12/270G 3.2SN BK BX	1036590000	C.72	SCD 3.81/10/90G 3.2SN BK BX	1973130000	C.92	SCD-THR 3.81/06/180F 3.2SN BK BX	1031470000	C.77
SC-SMT 3.81/12/90G 1.5SN BK BX	1863090000	C.66	SCD 3.81/10/90G 3.2SN OR BX	1972820000	C.92	SCD-THR 3.81/06/180G 1.5SN BK BX	1031310000	C.76
SC-SMT 3.81/12/90G 3.2SN BK BX	1862730000	C.66	SCD 3.81/12/180F 3.2SN BK BX	1030830000	C.95	SCD-THR 3.81/06/180G 3.2SN BK BX	1030960000	C.76
SC-SMT 3.81/12/90LF 1.5SN BK BX	1862670000	C.67	SCD 3.81/12/180F 3.2SN OR BX	1030480000	C.95	SCD-THR 3.81/06/90F 1.5SN BK BX	1974870000	C.75
SC-SMT 3.81/12/90LF 3.2SN BK BX	1863820000	C.67	SCD 3.81/12/180G 3.2SN BK BX	1030310000	C.94	SCD-THR 3.81/06/90F 3.2SN BK BX	1974190000	C.75
SC-SMT 3.81/13/135G 1.5SN BK BX	1978040000	C.70	SCD 3.81/12/180G 3.2SN OR BX	1029970000	C.94	SCD-THR 3.81/06/90G 1.5SN BK BX	1974040000	C.74
SC-SMT 3.81/13/135G 3.2SN BK BX	1977740000	C.70	SCD 3.81/12/90F 3.2SN BK BX	1973620000	C.93	SCD-THR 3.81/06/90G 3.2SN BK BX	1973740000	C.74
SC-SMT 3.81/13/135LF 1.5 SN BK BX	1978490000	C.71	SCD 3.81/12/90F 3.2SN OR BX	1973300000	C.93	SCD-THR 3.81/08/180F 1.5SN BK BX	1031890000	C.77
SC-SMT 3.81/13/135LF 3.2 SN BK BX	1978190000	C.71	SCD 3.81/12/90G 3.2SN BK BX	1973140000	C.92	SCD-THR 3.81/08/180F 3.2SN BK BX	1031490000	C.77
SC-SMT 3.81/13/180G 1.5SN BK BX	1863950000	C.68	SCD 3.81/12/90G 3.2SN OR BX	1972830000	C.92	SCD-THR 3.81/08/180G 1.5SN BK BX	1031320000	C.76
SC-SMT 3.81/13/180G 3.2SN BK BX	1863350000	C.68	SCD 3.81/14/180F 3.2SN BK BX	1030840000	C.95	SCD-THR 3.81/08/180G 3.2SN BK BX	1030970000	C.76
SC-SMT 3.81/13/180LF 1.5SN BK BX	1864180000	C.69	SCD 3.81/14/180F 3.2SN OR BX	1030490000	C.95	SCD-THR 3.81/08/90F 1.5SN BK BX	1974900000	C.75
SC-SMT 3.81/13/180LF 3.2SN BK BX	1863430000	C.69	SCD 3.81/14/180G 3.2SN BK BX	1030320000	C.94	SCD-THR 3.81/08/90F 3.2SN BK BX	1974200000	C.75
SC-SMT 3.81/13/270F 1.5SN BK BX	1037450000	C.73	SCD 3.81/14/180G 3.2SN OR BX	1029980000	C.94	SCD-THR 3.81/08/90G 1.5SN BK BX	1974050000	C.74
SC-SMT 3.81/13/270F 3.2SN BK BX	1037120000	C.73	SCD 3.81/14/90F 3.2SN BK BX	1973630000	C.93	SCD-THR 3.81/08/90G 3.2SN BK BX	1973750000	C.74
SC-SMT 3.81/13/270G 1.5SN BK BX	1036950000	C.72	SCD 3.81/14/90F 3.2SN OR BX	1973310000	C.93	SCD-THR 3.81/10/180F 1.5SN BK BX	1031910000	C.77
SC-SMT 3.81/13/270G 3.2SN BK BX	1036610000	C.72	SCD 3.81/14/90G 3.2SN BK BX	1973150000	C.92	SCD-THR 3.81/10/180F 3.2SN BK BX	1031510000	C.77
SC-SMT 3.81/13/90G 1.5SN BK BX	1863100000	C.66	SCD 3.81/14/90G 3.2SN OR BX	1972840000	C.92	SCD-THR 3.81/10/180G 1.5SN BK BX	1031330000	C.76
SC-SMT 3.81/13/90G 3.2SN BK BX	1862740000	C.66	SCD 3.81/16/180F 3.2SN BK BX	1030850000	C.95	SCD-THR 3.81/10/180G 3.2SN BK BX	1030980000	C.76
SC-SMT 3.81/13/90LF 1.5SN BK BX	1862680000	C.67	SCD 3.81/16/180F 3.2SN OR BX	1030510000	C.95	SCD-THR 3.81/10/90F 1.5SN BK BX	1974920000	C.75
SC-SMT 3.81/13/90LF 3.2SN BK BX	1863840000	C.67	SCD 3.81/16/180G 3.2SN BK BX	1030340000	C.94	SCD-THR 3.81/10/90F 3.2SN BK BX	1974210000	C.75
SC-SMT 3.81/14/135G 1.5SN BK BX	1978050000	C.70	SCD 3.81/16/180G 3.2SN OR BX	1029990000	C.94	SCD-THR 3.81/10/90G 1.5SN BK BX	1974060000	C.74
SC-SMT 3.81/14/135G 3.2SN BK BX	1977750000	C.70	SCD 3.81/16/90F 3.2SN BK BX	1973640000	C.93	SCD-THR 3.81/10/90G 3.2SN BK BX	1973760000	C.74
SC-SMT 3.81/14/135LF 1.5 SN BK BX	1978500000	C.71	SCD 3.81/16/90F 3.2SN OR BX	1973320000	C.93	SCD-THR 3.81/12/180F 1.5SN BK BX	1031920000	C.77
SC-SMT 3.81/14/135LF 3.2 SN BK BX	1978200000	C.71	SCD 3.81/16/90G 3.2SN BK BX	1973160000	C.92	SCD-THR 3.81/12/180F 3.2SN BK BX	1031520000	C.77
SC-SMT 3.81/14/180G 1.5SN BK BX	1863960000	C.68	SCD 3.81/16/90G 3.2SN OR BX	1972850000	C.92	SCD-THR 3.81/12/180G 1.5SN BK BX	1031340000	C.76
SC-SMT 3.81/14/180G 3.2SN BK BX	1863370000	C.68	SCD 3.81/18/180F 3.2SN BK BX	1030860000	C.95	SCD-THR 3.81/12/180G 3.2SN BK BX	1030990000	C.76
SC-SMT 3.81/14/180LF 1.5SN BK BX	1864190000	C.69	SCD 3.81/18/180F 3.2SN OR BX	1030520000	C.95	SCD-THR 3.81/12/90F 1.5SN BK BX	1974950000	C.75
SC-SMT 3.81/14/180LF 3.2SN BK BX	1863440000	C.69	SCD 3.81/18/180G 3.2SN BK BX	1030350000	C.94	SCD-THR 3.81/12/90F 3.2SN BK BX	1974220000	C.75
SC-SMT 3.81/14/270F 1.5SN BK BX	1037460000	C.73	SCD 3.81/18/180G 3.2SN OR BX	1030010000	C.94	SCD-THR 3.81/12/90G 1.5SN BK BX	1974070000	C.74
SC-SMT 3.81/14/270F 3.2SN BK BX	1037130000	C.73	SCD 3.81/18/90F 3.2SN BK BX	1973650000	C.93	SCD-THR 3.81/12/90G 3.2SN BK BX	1973770000	C.74
SC-SMT 3.81/14/270G 1.5SN BK BX	1036960000	C.72	SCD 3.81/18/90F 3.2SN OR BX	1973330000	C.93	SCD-THR 3.81/14/180F 1.5SN BK BX	1031930000	C.77
SC-SMT 3.81/14/270G 3.2SN BK BX	1036620000	C.72	SCD 3.8					

Type	Order No.	Page	Type	Order No.	Page	Type	Order No.	Page
SCDV 3.81/32/90G 3.2SN OR BX	1032250000	C.98	SCDV-THR 3.81/28/180G 1.5SN BK BX	1035920000	C.82	SCZ 3.81/07/180LR SN OR BX	1971660000	C.103
SCDV-THR 3.81/04/180F 1.5SN BK BX	1036320000	C.83	SCDV-THR 3.81/28/180G 3.2SN BK BX	1035610000	C.82	SCZ 3.81/07/180LRZL SN BK BX	1237280000	C.105
SCDV-THR 3.81/04/180F 3.2SN BK BX	1035950000	C.83	SCDV-THR 3.81/28/90F 1.5SN BK BX	1034440000	C.81	SCZ 3.81/07/180LRZE SN OR BX	1237380000	C.105
SCDV-THR 3.81/04/180G 1.5SN BK BX	1035790000	C.82	SCDV-THR 3.81/30/180G 3.2SN BK BX	1034110000	C.81	SCZ 3.81/08/180F SN BK BX	1971370000	C.103
SCDV-THR 3.81/04/180G 3.2SN BK BX	1035470000	C.82	SCDV-THR 3.81/28/90G 1.5SN BK BX	1033940000	C.80	SCZ 3.81/08/180F SN OR BX	1970980000	C.103
SCDV-THR 3.81/04/90F 1.5SN BK BX	1034310000	C.81	SCDV-THR 3.81/28/90G 3.2SN BK BX	1033620000	C.80	SCZ 3.81/08/180F SN BK BX	1970780000	C.103
SCDV-THR 3.81/04/90F 3.2SN BK BX	1033970000	C.81	SCDV-THR 3.81/30/180F 1.5SN BK BX	1034600000	C.83	SCZ 3.81/08/180F SN OR BX	1970360000	C.103
SCDV-THR 3.81/04/90G 1.5SN BK BX	1033820000	C.80	SCDV-THR 3.81/30/180F 3.2SN BK BX	1036090000	C.83	SCZ 3.81/08/180FZE SN BK BX	1237490000	C.105
SCDV-THR 3.81/04/90G 3.2SN BK BX	1033490000	C.80	SCDV-THR 3.81/28/90F 1.5SN BK BX	1035930000	C.82	SCZ 3.81/08/180FZE SN OR BX	1237590000	C.105
SCDV-THR 3.81/06/180F 1.5SN BK BX	1036330000	C.83	SCDV-THR 3.81/30/180G 3.2SN BK BX	1035620000	C.82	SCZ 3.81/08/180FZE SN BK BX	1071830000	C.105
SCDV-THR 3.81/06/180F 3.2SN BK BX	1035960000	C.83	SCDV-THR 3.81/30/90F 1.5SN BK BX	1034450000	C.81	SCZ 3.81/08/180FZE SN OR BX	1237180000	C.105
SCDV-THR 3.81/06/180G 1.5SN BK BX	1035800000	C.82	SCDV-THR 3.81/30/90F 3.2SN BK BX	1034220000	C.81	SCZ 3.81/08/180G SN BK BX	1970080000	C.102
SCDV-THR 3.81/06/180G 3.2SN BK BX	1035480000	C.82	SCDV-THR 3.81/30/90G 1.5SN BK BX	1033950000	C.80	SCZ 3.81/08/180G SN OR BX	1969610000	C.102
SCDV-THR 3.81/06/90F 1.5SN BK BX	1034320000	C.81	SCDV-THR 3.81/30/90G 3.2SN BK BX	1033630000	C.80	SCZ 3.81/08/180GZE SN BK BX	1071740000	C.104
SCDV-THR 3.81/06/90F 3.2SN BK BX	1033980000	C.81	SCDV-THR 3.81/32/180F 1.5SN BK BX	1036470000	C.83	SCZ 3.81/08/180GZE SN OR BX	1237040000	C.104
SCDV-THR 3.81/06/90G 1.5SN BK BX	1033830000	C.80	SCDV-THR 3.81/32/180F 3.2SN BK BX	1036110000	C.83	SCZ 3.81/08/180LR SN BK BX	1972060000	C.103
SCDV-THR 3.81/06/90G 3.2SN BK BX	1033510000	C.80	SCDV-THR 3.81/32/180G 1.5SN BK BX	1035940000	C.82	SCZ 3.81/08/180LR SN OR BX	1971670000	C.103
SCDV-THR 3.81/08/180F 1.5SN BK BX	1036340000	C.83	SCDV-THR 3.81/32/180G 3.2SN BK BX	1035630000	C.82	SCZ 3.81/08/180LRZE SN BK BX	1237290000	C.105
SCDV-THR 3.81/08/180F 3.2SN BK BX	1035970000	C.83	SCDV-THR 3.81/32/90F 1.5SN BK BX	1034460000	C.81	SCZ 3.81/08/180LRZE SN OR BX	1237390000	C.105
SCDV-THR 3.81/08/180G 1.5SN BK BX	1035810000	C.82	SCDV-THR 3.81/32/90F 3.2SN BK BX	1034130000	C.81	SCZ 3.81/09/180F SN BK BX	1971400000	C.103
SCDV-THR 3.81/08/180G 3.2SN BK BX	1035490000	C.82	SCDV-THR 3.81/32/90G 1.5SN BK BX	1033960000	C.80	SCZ 3.81/09/180F SN OR BX	1970990000	C.103
SCDV-THR 3.81/08/90F 1.5SN BK BX	1034330000	C.81	SCDV-THR 3.81/32/90G 3.2SN BK BX	1033640000	C.80	SCZ 3.81/09/180F SN BK BX	1970790000	C.103
SCDV-THR 3.81/08/90F 3.2SN BK BX	1033990000	C.81	SCZ 3.81/02/180F SN BK BX	1971290000	C.103	SCZ 3.81/09/180F SN OR BX	1970390000	C.103
SCDV-THR 3.81/08/90G 1.5SN BK BX	1033840000	C.80	SCZ 3.81/02/180F SN OR BX	1970910000	C.103	SCZ 3.81/09/180FZE SN BK BX	1237510000	C.105
SCDV-THR 3.81/08/90G 3.2SN BK BX	1033520000	C.80	SCZ 3.81/02/180F SN BK BX	1970700000	C.103	SCZ 3.81/09/180FZE SN OR BX	1237610000	C.105
SCDV-THR 3.81/10/180F 1.5SN BK BX	1036350000	C.83	SCZ 3.81/02/180F SN OR BX	1970260000	C.103	SCZ 3.81/09/180FZE SN BK BX	1071840000	C.105
SCDV-THR 3.81/10/180F 3.2SN BK BX	1035980000	C.83	SCZ 3.81/02/180G SN BK BX	1970010000	C.102	SCZ 3.81/09/180FZE SN OR BX	1237190000	C.105
SCDV-THR 3.81/10/180G 1.5SN BK BX	1035820000	C.82	SCZ 3.81/02/180G SN OR BX	1969520000	C.102	SCZ 3.81/09/180G SN BK BX	1970090000	C.102
SCDV-THR 3.81/10/180G 3.2SN BK BX	1035510000	C.82	SCZ 3.81/02/180LR SN BK BX	1971980000	C.103	SCZ 3.81/09/180G SN OR BX	1969630000	C.102
SCDV-THR 3.81/10/90F 1.5SN BK BX	1034340000	C.81	SCZ 3.81/02/180LR SN OR BX	1971580000	C.103	SCZ 3.81/09/180GZE SN BK BX	1071750000	C.104
SCDV-THR 3.81/10/90F 3.2SN BK BX	1034010000	C.81	SCZ 3.81/03/180F SN BK BX	1971310000	C.103	SCZ 3.81/09/180GZE SN OR BX	1237070000	C.104
SCDV-THR 3.81/10/90G 1.5SN BK BX	1033850000	C.80	SCZ 3.81/03/180F SN OR BX	1970920000	C.103	SCZ 3.81/09/180LR SN BK BX	1972080000	C.103
SCDV-THR 3.81/10/90G 3.2SN BK BX	1033530000	C.80	SCZ 3.81/03/180F SN BK BX	1970710000	C.103	SCZ 3.81/09/180LR SN OR BX	1971680000	C.103
SCDV-THR 3.81/12/180F 1.5SN BK BX	1036360000	C.83	SCZ 3.81/03/180F SN OR BX	1970270000	C.103	SCZ 3.81/09/180LRZE SN BK BX	1237300000	C.105
SCDV-THR 3.81/12/180F 3.2SN BK BX	1035990000	C.83	SCZ 3.81/03/180G SN BK BX	1970020000	C.102	SCZ 3.81/09/180LRZE SN OR BX	1237400000	C.105
SCDV-THR 3.81/12/180G 1.5SN BK BX	1035830000	C.82	SCZ 3.81/03/180G SN OR BX	1969540000	C.102	SCZ 3.81/10/180F SN BK BX	1971410000	C.103
SCDV-THR 3.81/12/180G 3.2SN BK BX	1035520000	C.82	SCZ 3.81/03/180LR SN BK BX	1971990000	C.103	SCZ 3.81/10/180F SN OR BX	1971000000	C.103
SCDV-THR 3.81/12/90F 1.5SN BK BX	1034350000	C.81	SCZ 3.81/03/180LR SN OR BX	1971600000	C.103	SCZ 3.81/10/180F SN BK BX	1970800000	C.103
SCDV-THR 3.81/12/90F 3.2SN BK BX	1034020000	C.81	SCZ 3.81/04/180F SN BK BX	1971320000	C.103	SCZ 3.81/10/180F SN OR BX	1970410000	C.103
SCDV-THR 3.81/12/90G 1.5SN BK BX	1033860000	C.80	SCZ 3.81/04/180F SN OR BX	1970930000	C.103	SCZ 3.81/10/180FZE SN BK BX	1237520000	C.105
SCDV-THR 3.81/12/90G 3.2SN BK BX	1033540000	C.80	SCZ 3.81/04/180LR SN BK BX	1970720000	C.103	SCZ 3.81/10/180FZE SN OR BX	1237620000	C.105
SCDV-THR 3.81/14/180F 1.5SN BK BX	1036370000	C.83	SCZ 3.81/04/180LR SN OR BX	1970310000	C.103	SCZ 3.81/10/180FZE SN BK BX	1071850000	C.105
SCDV-THR 3.81/14/180F 3.2SN BK BX	1036010000	C.83	SCZ 3.81/04/180FZE SN BK BX	1237440000	C.105	SCZ 3.81/10/180FZE SN OR BX	1237200000	C.105
SCDV-THR 3.81/14/180G 1.5SN BK BX	1035840000	C.82	SCZ 3.81/04/180FZE SN OR BX	1237550000	C.105	SCZ 3.81/10/180G SN BK BX	1970100000	C.102
SCDV-THR 3.81/14/180G 3.2SN BK BX	1035530000	C.82	SCZ 3.81/04/180FZE SN BK BX	1237110000	C.105	SCZ 3.81/10/180G SN OR BX	1969640000	C.102
SCDV-THR 3.81/14/90F 1.5SN BK BX	1034360000	C.81	SCZ 3.81/04/180FZE SN OR BX	1237120000	C.105	SCZ 3.81/10/180GZE SN BK BX	1071760000	C.104
SCDV-THR 3.81/14/90F 3.2SN BK BX	1034030000	C.81	SCZ 3.81/04/180G SN BK BX	1970030000	C.102	SCZ 3.81/10/180GZE SN OR BX	1237080000	C.104
SCDV-THR 3.81/14/90G 1.5SN BK BX	1033870000	C.80	SCZ 3.81/04/180G SN OR BX	1969560000	C.102	SCZ 3.81/10/180LR SN BK BX	1972090000	C.103
SCDV-THR 3.81/14/90G 3.2SN BK BX	1033550000	C.80	SCZ 3.81/04/180GZE SN BK BX	1236990000	C.104	SCZ 3.81/10/180LR SN OR BX	1971690000	C.103
SCDV-THR 3.81/16/180F 1.5SN BK BX	1036380000	C.83	SCZ 3.81/04/180GZE SN OR BX	1237000000	C.104	SCZ 3.81/10/180LRZE SN BK BX	1237310000	C.105
SCDV-THR 3.81/16/180F 3.2SN BK BX	1036020000	C.83	SCZ 3.81/04/180LR SN BK BX	1972010000	C.103	SCZ 3.81/10/180LRZE SN OR BX	1237410000	C.105
SCDV-THR 3.81/16/180G 1.5SN BK BX	1035850000	C.82	SCZ 3.81/04/180LR SN OR BX	1971610000	C.103	SCZ 3.81/11/180F SN BK BX	1971510000	C.103
SCDV-THR 3.81/16/180G 3.2SN BK BX	1035540000	C.82	SCZ 3.81/04/180LRZE SN BK BX	1237230000	C.105	SCZ 3.81/11/180F SN OR BX	1971010000	C.103
SCDV-THR 3.81/16/90F 1.5SN BK BX	1034370000	C.81	SCZ 3.81/04/180LRZE SN OR BX	1237340000	C.105	SCZ 3.81/11/180F SN BK BX	1970810000	C.103
SCDV-THR 3.81/16/90F 3.2SN BK BX	1034040000	C.81	SCZ 3.81/05/180F SN BK BX	1971340000	C.103	SCZ 3.81/11/180F SN OR BX	1970420000	C.103
SCDV-THR 3.81/16/90G 1.5SN BK BX	1033880000	C.80	SCZ 3.81/05/180F SN OR BX	1970940000	C.103	SCZ 3.81/11/180FZE SN BK BX	1237530000	C.105
SCDV-THR 3.81/16/90G 3.2SN BK BX	1033560000	C.80	SCZ 3.81/05/180F SN BK BX	1970740000	C.103	SCZ 3.81/11/180FZE SN OR BX	1237630000	C.105
SCDV-THR 3.81/18/180F 1.5SN BK BX	1036390000	C.83	SCZ 3.81/05/180F SN OR BX	1970320000	C.103	SCZ 3.81/11/180FZE SN BK BX	1071860000	C.105
SCDV-THR 3.81/18/180F 3.2SN BK BX	1036030000	C.83	SCZ 3.81/05/180FZE SN BK BX	1237450000	C.105	SCZ 3.81/11/180FZE SN OR BX	1237210000	C.105
SCDV-THR 3.81/18/180G 1.5SN BK BX	1035860000	C.82	SCZ 3.81/05/180FZE SN OR BX	1237560000	C.105	SCZ 3.81/11/180G SN BK BX	1970110000	C.102
SCDV-THR 3.81/18/180G 3.2SN BK BX	1035550000	C.82	SCZ 3.81/05/180FZE SN BK BX	1071790000	C.105	SCZ 3.81/11/180G SN OR BX	1969660000	C.102
SCDV-THR 3.81/18/90F 1.5SN BK BX	1034380000	C.81	SCZ 3.81/05/180FZE SN OR BX	1237130000	C.105	SCZ 3.81/11/180GZE SN BK BX	1071770000	C.104
SCDV-THR 3.81/18/90F 3.2SN BK BX	1034050000	C.81	SCZ 3.81/05/180G SN BK BX	1970050000	C.102	SCZ 3.81/11/180GZE SN OR BX	1237090000	C.104
SCDV-THR 3.81/18/90G 1.5SN BK BX	1033890000	C.80	SCZ 3.81/05/180G SN OR BX	1969570000	C.102	SCZ 3.81/11/180FZE SN BK BX	1972110000	C.103
SCDV-THR 3.81/18/90G 3.2SN BK BX	1033570000	C.80	SCZ 3.81/05/180GZE SN BK BX	1071710000	C.104	SCZ 3.81/11/180FZE SN OR BX	1971700000	C.103
SCDV-THR 3.81/20/180F 1.5SN BK BX	1036410000	C.83	SCZ 3.81/05/180GZE SN OR BX	1237010000	C.104	SCZ 3.81/11/180LR SN BK BX	1971020000	C.103
SCDV-THR 3.81/20/180F 3.2SN BK BX	1036040000	C.83	SCZ 3.81/05/180LR SN BK BX	1972020000	C.103	SCZ 3.81/11/180LRZE SN BK BX	1237320000	C.105
SCDV-THR 3.81/20/180G 1.5SN BK BX	1035870000	C.82	SCZ 3.81/05/180LR SN OR BX	1971630000	C.103	SCZ 3.81/12/180F SN BK BX	1971520000	C.103
SCDV-THR 3.81/20/180G 3.2SN BK BX	1035560000	C.82	SCZ 3.81/05/180LRZE SN BK BX	1237240000	C.105	SCZ 3.81/12/180F SN OR BX	1971020000	C.103
SCDV-THR 3.81/20/90F 1.5SN BK BX	1034390000	C.81	SCZ 3.81/05/180LRZE SN OR BX	1237350000	C.105	SCZ 3.81/12/180F SN BK BX	1970830000	C.103
SCDV-THR 3.81/20/90F 3.2SN BK BX	1034060000	C.81	SCZ 3.81/06/180F SN BK BX	1971350000	C.103	SCZ 3.81/12/180F SN OR BX	1970430000	C.103
SCDV-THR 3.81/20/90G 1.5SN BK BX	1033900000	C.80	SCZ 3.81/06/180F SN OR BX	1970960000	C.103	SCZ 3.81/12/180FZE SN BK BX	1237540000	C.105
SCDV-THR 3.81/20/90G 3.2SN BK BX	1033580000	C.80	SCZ 3.81/06/180F SN BK BX	1970760000	C.103	SCZ 3.81/12/180FZE SN OR BX	1237640000	C.105
SCDV-THR 3.81/22/180F 1.5SN BK BX	1036420000	C.83	SCZ 3.81/06/180F SN OR BX	1970340000	C.103	SCZ 3.81/12/180FZE SN BK BX	1071870000	C.105
SCDV-THR 3.81/22/180F 3.2SN BK BX	1036050000	C.83	SCZ 3.81/06/180FZE SN BK BX	1237470000	C.105	SCZ 3.81/12/180FZE SN OR BX	1237220000	C.105
SCDV-THR 3.81/22/180G 1.5SN BK BX	1035880000	C.82	SCZ 3.81/06/180FZE SN OR BX	1237570000	C.105	SCZ 3.81/12/180G SN BK BX	1970120000	C.102
SCDV-THR 3.81/22/180G 3.2SN BK BX	1035570000	C.82	SCZ 3.81/06/180FZE SN BK BX	1071810000	C.105	SCZ 3.81/12/180G SN OR BX	1969670000	C.102
SCDV-THR 3.81/22/90F 1.5SN BK BX	1034410000	C.81	SCZ 3.81/06/180FZE SN OR BX	1237140000	C.105	SCZ 3.81/12/180GZE SN BK BX	1071780000	C.104
SCDV-THR 3.81/22/90F 3.2SN BK BX	1034070000	C.81	SCZ 3.81/06/180G SN BK BX	1970060000	C.102	SCZ 3.81/12/180GZE SN OR BX	1237100000	C.104
SCDV-THR 3.81/22/90G 1.5SN BK BX	1033910000	C.80	SCZ 3.81/06/180G SN OR BX	1969580000	C.102	SCZ 3.81/12/180LR SN BK BX	1972120000	C.103
SCDV-THR 3.81/22/90G 3.2SN BK BX	1033							

Type	Order No.	Page	Type	Order No.	Page	Type	Order No.	Page
SDS 0.4X2.5X75	9009030000	D.22	SL 3.50/07/135F 3.2SN OR BX	1643380000	C.36	SL 3.50/21/180 3.2SN OR BX	1621440000	C.34
SDS 0.5X3.0X80	9008320000	D.22	SL 3.50/07/180 3.2SN OR BX	1604820000	C.34	SL 3.50/21/180F 3.2SN OR BX	1622220000	C.35
SDS 0.6X3.5X100	9008330000	J.3	SL 3.50/07/180F 3.2SN OR BX	1607550000	C.35	SL 3.50/21/180G 3.2SN OR BX	1621830000	C.35
SDS 0.8X4.0X100	9008340000	D.22	SL 3.50/07/180G 3.2SN OR BX	1604520000	C.35	SL 3.50/21/90 3.2SN OR BX	1619030000	C.32
SDS 0.8X4.0X125	9009020000	D.22	SL 3.50/07/90 3.2SN OR BX	1597260000	C.32	SL 3.50/21/90F 3.2SN OR BX	1619810000	C.33
SDS 1.0X5.5X150	9008350000	D.22	SL 3.50/07/90F 3.2SN OR BX	1607090000	C.33	SL 3.50/21/90G 3.2SN OR BX	1619420000	C.33
SDS 1.2X6.5X150	9009010000	D.22	SL 3.50/07/90G 3.2SN OR BX	1605120000	C.33	SL 3.50/22/135F 3.2SN OR BX	1643530000	C.36
SF 10 BEZ. 0-9	0332400000	D.18	SL 3.50/08/135F 3.2SN OR BX	1643390000	C.36	SL 3.50/22/180 3.2SN OR BX	1621450000	C.34
SF 10 BEZ. 1-10	0331500001	D.18	SL 3.50/08/180 3.2SN OR BX	1604830000	C.34	SL 3.50/22/180F 3.2SN OR BX	1622230000	C.35
SF 10 BEZ. 11-20	0331500011	D.18	SL 3.50/08/180F 3.2SN OR BX	1607560000	C.35	SL 3.50/22/180G 3.2SN OR BX	1621840000	C.35
SG 10	0332500000	D.18	SL 3.50/08/180G 3.2SN OR BX	1604530000	C.35	SL 3.50/22/90 3.2SN OR BX	1619040000	C.32
SG 10 BEZ. 1	0332500001	D.18	SL 3.50/08/90 3.2SN OR BX	1597270000	C.32	SL 3.50/22/90F 3.2SN OR BX	1619820000	C.33
SG 10 BEZ. 2	0332500002	D.18	SL 3.50/08/90F 3.2SN OR BX	1607100000	C.33	SL 3.50/22/90G 3.2SN OR BX	1619430000	C.33
SG 10 BEZ. 3	0332500003	D.18	SL 3.50/08/90G 3.2SN OR BX	1605130000	C.33	SL 3.50/23/135F 3.2SN OR BX	1643540000	C.36
SG 10 BEZ. 4	0332500004	D.18	SL 3.50/09/135F 3.2SN OR BX	1643400000	C.36	SL 3.50/23/180 3.2SN OR BX	1621460000	C.34
SG 10 BEZ. 5	0332500005	D.18	SL 3.50/09/180 3.2SN OR BX	1604840000	C.34	SL 3.50/23/180F 3.2SN OR BX	1622240000	C.35
SG 10 BEZ. 6	0332500006	D.18	SL 3.50/09/180F 3.2SN OR BX	1607570000	C.35	SL 3.50/23/180G 3.2SN OR BX	1621850000	C.35
SG 10 BEZ. 7	0332500007	D.18	SL 3.50/09/180G 3.2SN OR BX	1604540000	C.35	SL 3.50/23/90 3.2SN OR BX	1619050000	C.32
SG 10 BEZ. 8	0332500008	D.18	SL 3.50/09/90 3.2SN OR BX	1597280000	C.32	SL 3.50/23/90F 3.2SN OR BX	1619830000	C.33
SG 10 BEZ. 9	0332500009	D.18	SL 3.50/09/90F 3.2SN OR BX	1607110000	C.33	SL 3.50/23/90G 3.2SN OR BX	1619440000	C.33
SHL-SMT 5.00/02GL 1.5BX	1069620000	I.19	SL 3.50/09/90G 3.2SN OR BX	1605140000	C.33	SL 3.50/24/135F 3.2SN OR BX	1643550000	C.36
SHL-SMT 5.00/02GL 3.2BX	1069750000	I.19	SL 3.50/10/135F 3.2SN OR BX	1643410000	C.36	SL 3.50/24/180 3.2SN OR BX	1621470000	C.34
SHL-SMT 5.00/02GL 4.2RL	1069650000	I.19	SL 3.50/10/180 3.2SN OR BX	1604850000	C.34	SL 3.50/24/180F 3.2SN OR BX	1622250000	C.35
SHL-SMT 5.00/02GL 5.9RL	1069780000	I.19	SL 3.50/10/180F 3.2SN OR BX	1607580000	C.35	SL 3.50/24/180G 3.2SN OR BX	1621860000	C.35
SHL-SMT 5.00/02GR 1.5BX	1069550000	I.19	SL 3.50/10/180G 3.2SN OR BX	1604550000	C.35	SL 3.50/24/90 3.2SN OR BX	1619060000	C.32
SHL-SMT 5.00/02GR 3.2BX	1069680000	I.19	SL 3.50/10/90 3.2SN OR BX	1597290000	C.32	SL 3.50/24/90F 3.2SN OR BX	1619840000	C.33
SHL-SMT 5.00/02GR 4.2RL	1069680000	I.19	SL 3.50/10/90F 3.2SN OR BX	1607120000	C.33	SL 3.50/24/90G 3.2SN OR BX	1619450000	C.33
SHL-SMT 5.00/02GR 5.9RL	1069720000	I.19	SL 3.50/10/90G 3.2SN OR BX	1605150000	C.33	SL 5.00/02/135 3.2SN OR BX	1630250000	C.148
SHL-SMT 5.00/03GL 1.5BX	1063210000	I.21	SL 3.50/11/135F 3.2SN OR BX	1643420000	C.36	SL 5.00/02/135B 3.2SN OR BX	1630480000	C.149
SHL-SMT 5.00/03GL 1.5RL	1063240000	I.21	SL 3.50/11/180 3.2SN OR BX	1604860000	C.34	SL 5.00/02/180 3.2SN OR BX	1581320000	C.146
SHL-SMT 5.00/03GL 4.2BX	1069630000	I.21	SL 3.50/11/180F 3.2SN OR BX	1607590000	C.35	SL 5.00/02/180B 3.2SN OR BX	1581780000	C.147
SHL-SMT 5.00/03GL 4.2RL	1069660000	I.21	SL 3.50/11/180G 3.2SN OR BX	1604560000	C.35	SL 5.00/02/90 3.2SN OR BX	1571130000	C.144
SHL-SMT 5.00/03GL 5.9BX	1069760000	I.21	SL 3.50/11/90 3.2SN OR BX	1597300000	C.32	SL 5.00/02/90B 3.2SN OR BX	1580860000	C.145
SHL-SMT 5.00/03GL 5.9RL	1069790000	I.21	SL 3.50/11/90F 3.2SN OR BX	1607130000	C.33	SL 5.00/03/135 3.2SN OR BX	1630260000	C.148
SHL-SMT 5.00/03GR 1.5BX	1063140000	I.21	SL 3.50/11/90G 3.2SN OR BX	1605160000	C.33	SL 5.00/03/135B 3.2SN OR BX	1630490000	C.149
SHL-SMT 5.00/03GR 1.5RL	1063170000	I.21	SL 3.50/12/135F 3.2SN OR BX	1643430000	C.36	SL 5.00/03/180 3.2SN OR BX	1581330000	C.146
SHL-SMT 5.00/03GR 4.2BX	1069560000	I.21	SL 3.50/12/180 3.2SN OR BX	1604870000	C.34	SL 5.00/03/180B 3.2SN OR BX	1581790000	C.147
SHL-SMT 5.00/03GR 4.2RL	1069590000	I.21	SL 3.50/12/180F 3.2SN OR BX	1607600000	C.35	SL 5.00/03/90 3.2SN OR BX	1571140000	C.144
SHL-SMT 5.00/03GR 5.9BX	1069690000	I.21	SL 3.50/12/180G 3.2SN OR BX	1604570000	C.35	SL 5.00/03/90B 3.2SN OR BX	1580870000	C.145
SHL-SMT 5.00/03GR 5.9RL	1069730000	I.21	SL 3.50/12/90 3.2SN OR BX	1597310000	C.32	SL 5.00/04/135 3.2SN OR BX	1630270000	C.148
SHL-SMT 5.00/04GL 1.5BX	1063220000	I.23	SL 3.50/12/90F 3.2SN OR BX	1607140000	C.33	SL 5.00/04/135B 3.2SN OR BX	1630500000	C.149
SHL-SMT 5.00/04GL 1.5RL	1063250000	I.23	SL 3.50/12/90G 3.2SN OR BX	1605170000	C.33	SL 5.00/04/180 3.2SN OR BX	1581340000	C.146
SHL-SMT 5.00/04GL 4.2BX	1069640000	I.23	SL 3.50/13/135F 3.2SN OR BX	1643440000	C.36	SL 5.00/04/180B 3.2SN OR BX	1581800000	C.147
SHL-SMT 5.00/04GL 4.2RL	1069670000	I.23	SL 3.50/13/180 3.2SN OR BX	1604880000	C.34	SL 5.00/04/90 3.2SN OR BX	1571150000	C.144
SHL-SMT 5.00/04GL 5.9BX	1069770000	I.23	SL 3.50/13/180F 3.2SN OR BX	1607610000	C.35	SL 5.00/04/90B 3.2SN OR BX	1580880000	C.145
SHL-SMT 5.00/04GL 5.9RL	1069810000	I.23	SL 3.50/13/180G 3.2SN OR BX	1604580000	C.35	SL 5.00/05/135 3.2SN OR BX	1630280000	C.148
SHL-SMT 5.00/04GR 1.5BX	1063150000	I.23	SL 3.50/13/90 3.2SN OR BX	1597320000	C.32	SL 5.00/05/135B 3.2SN OR BX	1630510000	C.149
SHL-SMT 5.00/04GR 1.5RL	1063180000	I.23	SL 3.50/13/90F 3.2SN OR BX	1607150000	C.33	SL 5.00/05/180 3.2SN OR BX	1581350000	C.146
SHL-SMT 5.00/04GR 4.2BX	1069570000	I.23	SL 3.50/13/90G 3.2SN OR BX	1605180000	C.33	SL 5.00/05/180B 3.2SN OR BX	1581810000	C.147
SHL-SMT 5.00/04GR 4.2RL	1069610000	I.23	SL 3.50/14/135F 3.2SN OR BX	1643450000	C.36	SL 5.00/05/90 3.2SN OR BX	1571160000	C.144
SHL-SMT 5.00/04GR 5.9BX	1069710000	I.23	SL 3.50/14/180 3.2SN OR BX	1604890000	C.34	SL 5.00/05/90B 3.2SN OR BX	1580890000	C.145
SHL-SMT 5.00/04GR 5.9RL	1069740000	I.23	SL 3.50/14/180F 3.2SN OR BX	1607620000	C.35	SL 5.00/06/135 3.2SN OR BX	1630290000	C.148
SK DEMO CH20M12	1111630000	I.18	SL 3.50/14/180G 3.2SN OR BX	1604590000	C.35	SL 5.00/06/135B 3.2SN OR BX	1630520000	C.149
SK DEMO CH20M22	1105600000	I.22	SL 3.50/14/90 3.2SN OR BX	1597330000	C.32	SL 5.00/06/180 3.2SN OR BX	1581360000	C.146
SK DEMO CH20M45	1111640000	I.24	SL 3.50/14/90F 3.2SN OR BX	1607160000	C.33	SL 5.00/06/180B 3.2SN OR BX	1581820000	C.147
SK Demo CH20M6	1203310000	I.16	SL 3.50/14/90G 3.2SN OR BX	1605190000	C.33	SL 5.00/06/90 3.2SN OR BX	1571170000	C.144
SL 135 BB15R DR	1064500000	D.6	SL 3.50/15/135F 3.2SN OR BX	1643460000	C.36	SL 5.00/06/90B 3.2SN OR BX	1580900000	C.145
SL 135 BB15R SW	1363700000	D.6	SL 3.50/15/180 3.2SN OR BX	1604900000	C.34	SL 5.00/07/135 3.2SN OR BX	1630300000	C.148
SL 3.5 FLA 1.5/1.75/8	1597630000	D.8	SL 3.50/15/180F 3.2SN OR BX	1607630000	C.35	SL 5.00/07/135B 3.2SN OR BX	1630530000	C.149
SL 3.5 FLA 1.5/8	1597510000	D.8	SL 3.50/15/180G 3.2SN OR BX	1604600000	C.35	SL 5.00/07/180 3.2SN OR BX	1581370000	C.146
SL 3.5 FLA 2.3/1.75/8	1597640000	D.8	SL 3.50/15/90 3.2SN OR BX	1597340000	C.32	SL 5.00/07/180B 3.2SN OR BX	1581830000	C.147
SL 3.5 FLA 2.3/8	1597520000	D.8	SL 3.50/15/90F 3.2SN OR BX	1607170000	C.33	SL 5.00/07/90 3.2SN OR BX	1571180000	C.144
SL 3.5 FLA 4.0/1.75/8	1597650000	D.8	SL 3.50/15/90G 3.2SN OR BX	1605200000	C.33	SL 5.00/07/90B 3.2SN OR BX	1580910000	C.145
SL 3.5 FLA 4.0/8	1597530000	D.8	SL 3.50/16/135F 3.2SN OR BX	1643470000	C.36	SL 5.00/08/135 3.2SN OR BX	1630310000	C.148
SL 3.50/02/135F 3.2SN OR BX	1643330000	C.36	SL 3.50/16/180 3.2SN OR BX	1604910000	C.34	SL 5.00/08/135B 3.2SN OR BX	1630540000	C.149
SL 3.50/02/180 3.2SN OR BX	1604770000	C.34	SL 3.50/16/180F 3.2SN OR BX	1607640000	C.35	SL 5.00/08/180 3.2SN OR BX	1581380000	C.146
SL 3.50/02/180F 3.2SN OR BX	1607500000	C.35	SL 3.50/16/180G 3.2SN OR BX	1604610000	C.35	SL 5.00/08/180B 3.2SN OR BX	1581840000	C.147
SL 3.50/02/180G 3.2SN OR BX	1604470000	C.35	SL 3.50/16/90 3.2SN OR BX	1597350000	C.32	SL 5.00/08/90 3.2SN OR BX	1571190000	C.144
SL 3.50/02/90 3.2SN OR BX	1597210000	C.32	SL 3.50/16/90F 3.2SN OR BX	1607180000	C.33	SL 5.00/08/90B 3.2SN OR BX	1580920000	C.145
SL 3.50/02/90F 3.2SN OR BX	1607040000	C.33	SL 3.50/16/90G 3.2SN OR BX	1605210000	C.33	SL 5.00/09/135 3.2SN OR BX	1630320000	C.148
SL 3.50/02/90G 3.2SN OR BX	1605070000	C.33	SL 3.50/17/135F 3.2SN OR BX	1643480000	C.36	SL 5.00/09/135B 3.2SN OR BX	1630550000	C.149
SL 3.50/03/135F 3.2SN OR BX	1643340000	C.36	SL 3.50/17/180 3.2SN OR BX	1621400000	C.34	SL 5.00/09/180 3.2SN OR BX	1581390000	C.146
SL 3.50/03/180 3.2SN OR BX	1604780000	C.34	SL 3.50/17/180F 3.2SN OR BX	1622180000	C.35	SL 5.00/09/180B 3.2SN OR BX	1581850000	C.147
SL 3.50/03/180F 3.2SN OR BX	1607510000	C.35	SL 3.50/17/180G 3.2SN OR BX	1621790000	C.35	SL 5.00/09/90 3.2SN OR BX	1571200000	C.144
SL 3.50/03/180G 3.2SN OR BX	1604480000	C.35	SL 3.50/17/90 3.2SN OR BX	1618990000	C.32	SL 5.00/09/90B 3.2SN OR BX	1580930000	C.145
SL 3.50/03/90 3.2SN OR BX	1597220000	C.32	SL 3.50/17/90F 3.2SN OR BX	1619770000	C.33	SL 5.00/10/135 3.2SN OR BX	1630330000	C.148
SL 3.50/03/90F 3.2SN OR BX	1607050000	C.33	SL 3.50/17/90G 3.2SN OR BX	1619380000	C.33	SL 5.00/10/135B 3.2SN OR BX	1630560000	C.149
SL 3.50/03/90G 3.2SN OR BX	1605080000	C.33	SL 3.50/18/135F 3.2SN OR BX	1643490000	C.36	SL 5.00/10/180 3.2SN OR BX	1581400000	C.146
SL 3.50/04/135F 3.2SN OR BX	1643350000	C.36	SL 3.50/18/180 3.2SN OR BX	1621410000	C.34	SL 5.00/10/180B 3.2SN OR BX	1581860000	C.147
SL 3.50/04/180 3.2SN OR BX	1604790000	C.34	SL 3.50/18/180F 3.2SN OR BX	1622190000	C.35	SL 5.00/10/90 3.2SN OR BX	1571210000	C.144
SL 3.50/04/180F 3.2SN OR BX	1607520000	C.35	SL 3.50/18/180G 3.2SN OR BX	1621800000	C.35	SL 5.00/10/90B 3.2SN OR BX	1580940000	C.145
SL 3.50/04/180G 3.2SN OR BX	1604490000	C.35	SL 3.50/18/90 3.2SN OR BX	1619000000	C.32	SL 5.00/11/135 3.2SN OR BX	1630340000	C.148
SL 3.50/04/90 3.2SN OR BX	1597230000	C.32	SL 3.50/18/90F 3.2SN OR BX	1619780000	C.33	SL 5.00/11/135B 3.2SN OR BX	1630570000	C.149
SL 3.50/04/90F 3.2SN OR BX	1607060000	C.33	SL 3.50/18/90G 3.2SN OR BX	1619390000	C.33	SL 5.00/11/180 3		

Type	Order No.	Page	Type	Order No.	Page	Type	Order No.	Page
SL-SMT 3.50/22/90G 3.2SN BK BX	1841830000	C.26	SL-SMT 5.00/06/180 3.2SN BK BX	1840960000	C.138	SL-SMT 5.00/13/180LF 3.2SN BK BX	1841500000	C.140
SL-SMT 3.50/22/90LF 1.5SN BK BX	1805140000	C.27	SL-SMT 5.00/06/180G 1.5 SN BK RL	1797910000	C.139	SL-SMT 5.00/13/90 1.5SN BK BX	1797040000	C.134
SL-SMT 3.50/22/90LF 3.2SN BK BX	1842050000	C.27	SL-SMT 5.00/06/180G 1.5SN BK BX	1796670000	C.139	SL-SMT 5.00/13/90 3.2SN BK BX	1840000000	C.134
SL-SMT 3.50/23/135F 3.2SN BK BX	1003730000	C.37	SL-SMT 5.00/06/180G 3.2SN BK BX	1841200000	C.139	SL-SMT 5.00/13/90G 1.5SN BK BX	1797190000	C.135
SL-SMT 3.50/23/180F 3.2SN BK BX	1842980000	C.29	SL-SMT 5.00/06/180LF 1.5 SN BK RL	1797970000	C.141	SL-SMT 5.00/13/90G 3.2SN BK BX	1840230000	C.135
SL-SMT 3.50/23/180G 1.5SN BK BX	1753192001	C.30	SL-SMT 5.00/06/180LF 1.5SN BK BX	1796820000	C.140	SL-SMT 5.00/13/90LF 1.5SN BK BX	1797340000	C.136
SL-SMT 3.50/23/180G 3.2SN BK BX	1842520000	C.30	SL-SMT 5.00/06/180LF 3.2SN BK BX	1841430000	C.140	SL-SMT 5.00/13/90LF 3.2SN BK BX	1840460000	C.136
SL-SMT 3.50/23/180LF 1.5SN BK BX	1804920000	C.31	SL-SMT 5.00/06/180 1.5SN BK BX	1796970000	C.134	SL-SMT 5.00/14/180 1.5SN BK BX	1796600000	C.138
SL-SMT 3.50/23/180LF 3.2SN BK BX	1842750000	C.31	SL-SMT 5.00/06/180 3.2SN BK BX	1797660000	C.135	SL-SMT 5.00/14/180 3.2SN BK BX	1841050000	C.138
SL-SMT 3.50/23/90F 3.2SN BK BX	1842290000	C.28	SL-SMT 5.00/06/90G 1.5SN BK BX	1839930000	C.134	SL-SMT 5.00/14/180G 1.5SN BK BX	1796750000	C.139
SL-SMT 3.50/23/90G 1.5SN BK BX	1761752001	C.26	SL-SMT 5.00/06/90G 3.2SN BK BX	1797120000	C.135	SL-SMT 5.00/14/180G 3.2SN BK BX	1841280000	C.139
SL-SMT 3.50/23/90G 3.2SN BK BX	1841840000	C.26	SL-SMT 5.00/06/90G 1.5SN BK RL	1797730000	C.135	SL-SMT 5.00/14/180LF 1.5SN BK BX	1796900000	C.140
SL-SMT 3.50/23/90LF 1.5SN BK BX	1805150000	C.27	SL-SMT 5.00/06/90G 3.2SN BK BX	1840160000	C.135	SL-SMT 5.00/14/180LF 3.2SN BK BX	1841510000	C.140
SL-SMT 3.50/23/90LF 3.2SN BK BX	1842060000	C.27	SL-SMT 5.00/06/90LF 1.5SN BK BX	1797270000	C.136	SL-SMT 5.00/14/90 1.5SN BK BX	1797050000	C.134
SL-SMT 3.50/24/135F 3.2SN BK BX	1003740000	C.37	SL-SMT 5.00/06/90LF 1.5SN BK RL	1797790000	C.137	SL-SMT 5.00/14/90 3.2SN BK BX	1840010000	C.134
SL-SMT 3.50/24/180F 3.2SN BK BX	1842990000	C.29	SL-SMT 5.00/06/90LF 3.2SN BK BX	1840390000	C.136	SL-SMT 5.00/14/90G 1.5SN BK BX	1797200000	C.135
SL-SMT 3.50/24/180G 1.5SN BK BX	1753202001	C.30	SL-SMT 5.00/07/180 1.5 SN BK RL	1797850000	C.139	SL-SMT 5.00/14/90G 3.2SN BK BX	1840240000	C.135
SL-SMT 3.50/24/180G 3.2SN BK BX	1842530000	C.30	SL-SMT 5.00/07/180 1.5SN BK BX	1796530000	C.138	SL-SMT 5.00/14/90LF 1.5SN BK BX	1797350000	C.136
SL-SMT 3.50/24/180LF 1.5SN BK BX	1804930000	C.31	SL-SMT 5.00/07/180 3.2SN BK BX	1840970000	C.138	SL-SMT 5.00/15/180 1.5SN BK BX	1840470000	C.136
SL-SMT 3.50/24/180LF 3.2SN BK BX	1842760000	C.31	SL-SMT 5.00/07/180G 1.5 SN BK RL	1797920000	C.139	SL-SMT 5.00/15/180 3.2SN BK BX	1796610000	C.138
SL-SMT 3.50/24/90F 3.2SN BK BX	1842300000	C.28	SL-SMT 5.00/07/180G 1.5SN BK BX	1796880000	C.139	SL-SMT 5.00/15/180 3.2SN BK BX	1841060000	C.138
SL-SMT 3.50/24/90G 1.5SN BK BX	1761762001	C.26	SL-SMT 5.00/07/180G 3.2SN BK BX	1841210000	C.139	SL-SMT 5.00/15/180G 1.5SN BK BX	1796760000	C.139
SL-SMT 3.50/24/90G 3.2SN BK BX	1841850000	C.26	SL-SMT 5.00/07/180LF 1.5SN BK BX	1796830000	C.140	SL-SMT 5.00/15/180G 3.2SN BK BX	1841290000	C.139
SL-SMT 3.50/24/90LF 1.5SN BK BX	1805160000	C.27	SL-SMT 5.00/07/180LF 3.2SN BK BX	1841440000	C.140	SL-SMT 5.00/15/180LF 1.5SN BK BX	1796910000	C.140
SL-SMT 3.50/24/90LF 3.2SN BK BX	1842070000	C.27	SL-SMT 5.00/07/90 1.5SN BK BX	1796980000	C.134	SL-SMT 5.00/15/180LF 3.2SN BK BX	1841520000	C.140
SL-SMT 5.00/02/180 1.5SN BK BX	1796480000	C.138	SL-SMT 5.00/07/90 1.5SN BK RL	1797670000	C.135	SL-SMT 5.00/15/180 1.5SN BK BX	1797060000	C.134
SL-SMT 5.00/02/180 1.5SN BK RL	1797800000	C.139	SL-SMT 5.00/07/180G 1.5SN BK BX	1839940000	C.134	SL-SMT 5.00/15/180 3.2SN BK BX	1840020000	C.134
SL-SMT 5.00/02/180 3.2SN BK BX	1840920000	C.138	SL-SMT 5.00/07/90G 1.5SN BK BX	1797130000	C.135	SL-SMT 5.00/15/90G 1.5SN BK BX	1797210000	C.135
SL-SMT 5.00/02/180G 1.5 SN BK RL	1797870000	C.139	SL-SMT 5.00/07/90G 1.5SN BK RL	1797740000	C.135	SL-SMT 5.00/15/90G 3.2SN BK BX	1840250000	C.135
SL-SMT 5.00/02/180G 1.5SN BK BX	1796630000	C.139	SL-SMT 5.00/07/90LF 3.2SN BK BX	1840170000	C.136	SL-SMT 5.00/15/90LF 1.5SN BK BX	1797360000	C.136
SL-SMT 5.00/02/180G 3.2SN BK BX	1841180000	C.139	SL-SMT 5.00/07/90LF 1.5SN BK BX	1797280000	C.135	SL-SMT 5.00/15/90LF 3.2SN BK BX	1840480000	C.136
SL-SMT 5.00/02/180LF 1.5 SN BK RL	1797930000	C.141	SL-SMT 5.00/07/90LF 3.2SN BK BX	1840400000	C.136	SL-SMT 5.00/16/180 1.5SN BK BX	1796620000	C.138
SL-SMT 5.00/02/180LF 1.5SN BK BX	1796780000	C.140	SL-SMT 5.00/08/180 1.5 SN BK RL	1797860000	C.139	SL-SMT 5.00/16/180 3.2SN BK BX	1841070000	C.138
SL-SMT 5.00/02/180LF 3.2SN BK BX	1841390000	C.140	SL-SMT 5.00/08/180 1.5SN BK BX	1796540000	C.138	SL-SMT 5.00/16/180G 1.5SN BK BX	1796770000	C.139
SL-SMT 5.00/02/90 1.5SN BK BX	1796930000	C.134	SL-SMT 5.00/08/180 3.2SN BK BX	1840980000	C.138	SL-SMT 5.00/16/180G 3.2SN BK BX	1841300000	C.139
SL-SMT 5.00/02/90 1.5SN BK RL	1797820000	C.135	SL-SMT 5.00/08/180G 1.5SN BK BX	1796690000	C.139	SL-SMT 5.00/16/180LF 1.5SN BK BX	1796920000	C.140
SL-SMT 5.00/02/90 3.2SN BK BX	1839980000	C.134	SL-SMT 5.00/08/180G 3.2SN BK BX	1841220000	C.139	SL-SMT 5.00/16/180LF 3.2SN BK BX	1841530000	C.140
SL-SMT 5.00/02/90G 1.5SN BK BX	1797080000	C.135	SL-SMT 5.00/08/180LF 1.5SN BK BX	1796940000	C.140	SL-SMT 5.00/16/180 1.5SN BK BX	1797070000	C.134
SL-SMT 5.00/02/90G 1.5SN BK RL	1797690000	C.135	SL-SMT 5.00/08/180LF 3.2SN BK BX	1841450000	C.140	SL-SMT 5.00/16/180 3.2SN BK BX	1840030000	C.134
SL-SMT 5.00/02/90G 3.2SN BK BX	1840120000	C.135	SL-SMT 5.00/08/90 1.5SN BK BX	1796990000	C.134	SL-SMT 5.00/16/90G 1.5SN BK BX	1797220000	C.135
SL-SMT 5.00/02/90LF 1.5SN BK BX	1797230000	C.136	SL-SMT 5.00/08/90 1.5SN BK RL	1797680000	C.135	SL-SMT 5.00/16/90G 3.2SN BK BX	1840260000	C.135
SL-SMT 5.00/02/90LF 1.5SN BK RL	1797750000	C.137	SL-SMT 5.00/08/90 3.2SN BK BX	1839950000	C.134	SL-SMT 5.00/16/90LF 1.5SN BK BX	1797370000	C.136
SL-SMT 5.00/02/90LF 3.2SN BK BX	1840350000	C.136	SL-SMT 5.00/08/90G 1.5SN BK BX	1797140000	C.135	SL-SMT 5.00/16/90LF 3.2SN BK BX	1840490000	C.136
SL-SMT 5.00/03/180 1.5 SN BK RL	1797810000	C.139	SL-SMT 5.00/08/90G 3.2SN BK BX	1840180000	C.135	SL-SMT 5.00/17/180 3.2SN BK BX	1841080000	C.138
SL-SMT 5.00/03/180 1.5SN BK BX	1796490000	C.138	SL-SMT 5.00/08/90LF 1.5SN BK BX	1797290000	C.136	SL-SMT 5.00/17/180 3.2SN BK BX	1841310000	C.139
SL-SMT 5.00/03/180 3.2SN BK BX	1840930000	C.138	SL-SMT 5.00/08/90LF 3.2SN BK BX	1840410000	C.136	SL-SMT 5.00/17/180LF 3.2SN BK BX	1841540000	C.140
SL-SMT 5.00/03/180G 1.5 SN BK RL	1797880000	C.139	SL-SMT 5.00/09/180 1.5SN BK BX	1796550000	C.138	SL-SMT 5.00/17/180 3.2SN BK BX	1840040000	C.134
SL-SMT 5.00/03/180G 1.5SN BK BX	1796640000	C.139	SL-SMT 5.00/09/180 3.2SN BK BX	1840990000	C.138	SL-SMT 5.00/17/90G 3.2SN BK BX	1840270000	C.135
SL-SMT 5.00/03/180G 3.2SN BK BX	1841170000	C.139	SL-SMT 5.00/09/180G 1.5SN BK BX	1796700000	C.139	SL-SMT 5.00/17/90LF 3.2SN BK BX	1840500000	C.136
SL-SMT 5.00/03/180LF 1.5 SN BK RL	1797940000	C.141	SL-SMT 5.00/09/180G 3.2SN BK BX	1841230000	C.139	SL-SMT 5.00/18/180 3.2SN BK BX	1841090000	C.138
SL-SMT 5.00/03/180LF 1.5SN BK BX	1796790000	C.140	SL-SMT 5.00/09/180LF 1.5SN BK BX	1796850000	C.140	SL-SMT 5.00/18/180G 3.2SN BK BX	1841320000	C.139
SL-SMT 5.00/03/180LF 3.2SN BK BX	1841400000	C.140	SL-SMT 5.00/09/180LF 3.2SN BK BX	1841460000	C.140	SL-SMT 5.00/18/180LF 3.2SN BK BX	1841550000	C.140
SL-SMT 5.00/03/90 1.5SN BK BX	1796940000	C.134	SL-SMT 5.00/09/90 1.5SN BK BX	1797000000	C.134	SL-SMT 5.00/18/180G 3.2SN BK BX	1840050000	C.134
SL-SMT 5.00/03/90 1.5SN BK RL	1797830000	C.135	SL-SMT 5.00/09/90 3.2SN BK BX	1839960000	C.134	SL-SMT 5.00/18/90G 3.2SN BK BX	1840280000	C.135
SL-SMT 5.00/03/90 3.2SN BK BX	1839990000	C.134	SL-SMT 5.00/09/90G 1.5SN BK BX	1797150000	C.135	SL-SMT 5.00/18/90LF 3.2SN BK BX	1840510000	C.136
SL-SMT 5.00/03/90G 1.5SN BK BX	1797090000	C.135	SL-SMT 5.00/09/90G 3.2SN BK BX	1840190000	C.135	SL-SMT 5.00/19/180 3.2SN BK BX	1841100000	C.138
SL-SMT 5.00/03/90G 1.5SN BK RL	1797700000	C.135	SL-SMT 5.00/09/90LF 1.5SN BK BX	1797300000	C.136	SL-SMT 5.00/19/180G 3.2SN BK BX	1841330000	C.139
SL-SMT 5.00/03/90G 3.2SN BK BX	1840130000	C.135	SL-SMT 5.00/09/90LF 3.2SN BK BX	1840420000	C.136	SL-SMT 5.00/19/180LF 3.2SN BK BX	1841560000	C.140
SL-SMT 5.00/03/90LF 1.5SN BK BX	1797240000	C.136	SL-SMT 5.00/10/180 1.5SN BK BX	1796560000	C.138	SL-SMT 5.00/19/90 3.2SN BK BX	1840060000	C.134
SL-SMT 5.00/03/90LF 1.5SN BK RL	1797760000	C.137	SL-SMT 5.00/10/180 3.2SN BK BX	1841000000	C.138	SL-SMT 5.00/19/90G 3.2SN BK BX	1840290000	C.135
SL-SMT 5.00/03/90LF 3.2SN BK BX	1840360000	C.136	SL-SMT 5.00/10/180G 1.5SN BK BX	1796710000	C.139	SL-SMT 5.00/19/90LF 3.2SN BK BX	1840520000	C.136
SL-SMT 5.00/04/180 1.5 SN BK RL	1841280000	C.139	SL-SMT 5.00/10/180G 3.2SN BK BX	1841240000	C.139	SL-SMT 5.00/20/180 3.2SN BK BX	1841110000	C.138
SL-SMT 5.00/04/180 1.5SN BK BX	1796500000	C.138	SL-SMT 5.00/10/180LF 1.5SN BK BX	1796860000	C.140	SL-SMT 5.00/20/180G 3.2SN BK BX	1841340000	C.139
SL-SMT 5.00/04/180 3.2SN BK BX	1840940000	C.138	SL-SMT 5.00/10/180LF 3.2SN BK BX	1841470000	C.140	SL-SMT 5.00/20/180LF 3.2SN BK BX	1841570000	C.140
SL-SMT 5.00/04/180G 1.5 SN BK RL	1797890000	C.139	SL-SMT 5.00/10/90 1.5SN BK BX	1797010000	C.134	SL-SMT 5.00/20/90 3.2SN BK BX	1840070000	C.134
SL-SMT 5.00/04/180G 1.5SN BK BX	1796650000	C.139	SL-SMT 5.00/10/90 3.2SN BK BX	1839970000	C.134	SL-SMT 5.00/20/90G 3.2SN BK BX	1840300000	C.135
SL-SMT 5.00/04/180G 3.2SN BK BX	1841180000	C.139	SL-SMT 5.00/10/90G 1.5SN BK BX	1797160000	C.135	SL-SMT 5.00/20/90LF 3.2SN BK BX	1840530000	C.136
SL-SMT 5.00/04/180LF 1.5 SN BK RL	1797950000	C.141	SL-SMT 5.00/10/90G 3.2SN BK BX	1840200000	C.135	SL-SMT 5.00/21/180 3.2SN BK BX	1841120000	C.138
SL-SMT 5.00/04/180LF 1.5SN BK BX	1796800000	C.140	SL-SMT 5.00/10/90LF 1.5SN BK BX	1797310000	C.136	SL-SMT 5.00/21/180G 3.2SN BK BX	1841350000	C.139
SL-SMT 5.00/04/180LF 3.2SN BK BX	1841410000	C.140	SL-SMT 5.00/10/90LF 3.2SN BK BX	1840430000	C.136	SL-SMT 5.00/21/180LF 3.2SN BK BX	1841580000	C.140
SL-SMT 5.00/04/90 1.5SN BK BX	1796590000	C.134	SL-SMT 5.00/11/180 1.5SN BK BX	1796570000	C.138	SL-SMT 5.00/21/90 3.2SN BK BX	1840080000	C.134
SL-SMT 5.00/04/90 1.5SN BK RL	1797640000	C.135	SL-SMT 5.00/11/180 3.2SN BK BX	1841020000	C.138	SL-SMT 5.00/21/90G 3.2SN BK BX	1840310000	C.135
SL-SMT 5.00/04/90 3.2SN BK BX	1839910000	C.134	SL-SMT 5.00/11/180G 1.5SN BK BX	1796720000	C.139	SL-SMT 5.00/21/90LF 3.2SN BK BX	1840540000	C.136
SL-SMT 5.00/04/90G 1.5SN BK BX	1797100000	C.135	SL-SMT 5.00/11/180G 3.2SN BK BX	1841250000	C.139	SL-SMT 5.00/22/180 3.2SN BK BX	1841130000	C.138
SL-SMT 5.00/04/90G 1.5SN BK RL	1797710000	C.135	SL-SMT 5.00/11/180LF 1.5SN BK BX	1796870000	C.140	SL-SMT 5.00/22/180G 3.2SN BK BX	1841360000	C.139
SL-SMT 5.00/04/90G 3.2SN BK BX	1840140000	C.135	SL-SMT 5.00/11/180LF 3.2SN BK BX	1841480000	C.140	SL-SMT 5.00/22/180LF 3.2SN BK BX	1841590000	C.140
SL-SMT 5.00/04/90LF 1.5SN BK BX	1797250000	C.136	SL-SMT 5.00/11/180 1.5SN BK BX	1797020000	C.134	SL-SMT 5.00/22/90 3.2SN BK BX	1840090000	C.134
SL-SMT 5.00/04/90LF 1.5SN BK RL	1797770							

Type	Order No.	Page	Type	Order No.	Page	Type	Order No.	Page
SL-SMT 5.08/14/90 3.2SN BK BX	1780070000	C.168	SL-SMT 5.08/21/90F 3.2SN BK BX	1837820000	C.170	SLD 3.50 V/24/90G 3.2 SN OR BX	1642290000	C.40
SL-SMT 5.08/14/90F 3.2SN BK BX	1837750000	C.170	SL-SMT 5.08/21/90G 1.5SN BK BX	1775192001	C.169	SLD 3.50 V/26/180F 3.2 SN OR BX	1891110000	C.43
SL-SMT 5.08/14/90G 1.5SN BK BX	1775122001	C.169	SL-SMT 5.08/21/90G 3.2SN BK BX	1780370000	C.169	SLD 3.50 V/28/180F 3.2 SN OR BX	1641300000	C.43
SL-SMT 5.08/14/90G 3.2SN BK BX	1780300000	C.169	SL-SMT 5.08/21/90F 1.5SN BK BX	1775422001	C.172	SLD 3.50 V/28/180F 3.2 SN OR BX	1642430000	C.41
SL-SMT 5.08/14/90LF 1.5SN BK BX	1775352001	C.172	SL-SMT 5.08/21/90LF 3.2SN BK BX	1780620000	C.172	SLD 3.50 V/28/90G 3.2 SN OR BX	1642300000	C.40
SL-SMT 5.08/14/90LF 3.2SN BK BX	1780550000	C.172	SL-SMT 5.08/22/180 1.5SN BK BX	1775802001	C.174	SLD 3.50 V/30/180F 3.2 SN OR BX	1891120000	C.43
SL-SMT 5.08/15/180 1.5SN BK BX	1775320001	C.174	SL-SMT 5.08/22/180F 3.2SN BK BX	1838180000	C.174	SLD 3.50 V/32/180F 3.2 SN OR BX	1641310000	C.43
SL-SMT 5.08/15/180 3.2SN BK BX	1838110000	C.174	SL-SMT 5.08/22/180F 3.2SN BK BX	1837950000	C.176	SLD 3.50 V/32/90F 3.2 SN OR BX	1642440000	C.41
SL-SMT 5.08/15/180F 3.2SN BK BX	1837910000	C.176	SL-SMT 5.08/22/180G 1.5SN BK BX	1776332001	C.175	SLD 3.50 V/32/90G 3.2 SN OR BX	1642310000	C.40
SL-SMT 5.08/15/180G 1.5SN BK BX	1776262001	C.175	SL-SMT 5.08/22/180G 3.2SN BK BX	1838410000	C.175	SLD 3.50 V/34/180F 3.2 SN OR BX	1891130000	C.43
SL-SMT 5.08/15/180G 3.2SN BK BX	1838340000	C.175	SL-SMT 5.08/22/180G 3.2SN BK BX	1776572001	C.178	SLD 3.50 V/36/180F 3.2 SN OR BX	1641320000	C.43
SL-SMT 5.08/15/180LF 1.5SN BK BX	1776492001	C.178	SL-SMT 5.08/22/180LF 3.2SN BK BX	1838640000	C.178	SLD 3.50 V/36/90F 3.2 SN OR BX	1642450000	C.41
SL-SMT 5.08/15/180LF 3.2SN BK BX	1838570000	C.178	SL-SMT 5.08/22/90 1.5SN BK BX	1774962001	C.168	SLD 3.50 V/36/90G 3.2 SN OR BX	1642320000	C.40
SL-SMT 5.08/15/90 1.5SN BK BX	1774892001	C.168	SL-SMT 5.08/22/90 3.2SN BK BX	1780150000	C.168	SLD 3.50 V/38/180F 3.2 SN OR BX	1891140000	C.43
SL-SMT 5.08/15/90 3.2SN BK BX	1780080000	C.168	SL-SMT 5.08/22/90F 1.5SN BK BX	1837830000	C.170	SLD 3.50 V/40/180F 3.2 SN OR BX	1641330000	C.43
SL-SMT 5.08/15/90F 3.2SN BK BX	1837760000	C.170	SL-SMT 5.08/22/90G 3.2SN BK BX	1775202001	C.169	SLD 3.50 V/40/90F 3.2 SN OR BX	1642460000	C.41
SL-SMT 5.08/15/90G 1.5SN BK BX	1775132001	C.169	SL-SMT 5.08/22/90G 3.2SN BK BX	1780380000	C.169	SLD 3.50 V/40/90G 3.2 SN OR BX	1642330000	C.40
SL-SMT 5.08/15/90G 3.2SN BK BX	1780310000	C.169	SL-SMT 5.08/22/90LF 1.5SN BK BX	1775432001	C.172	SLD 3.50 V/42/180F 3.2 SN OR BX	1891150000	C.43
SL-SMT 5.08/15/90LF 1.5SN BK BX	1775362001	C.172	SL-SMT 5.08/22/90LF 3.2SN BK BX	1780630000	C.172	SLD 3.50 V/42/180F 3.2 SN OR BX	1641340000	C.43
SL-SMT 5.08/15/90LF 3.2SN BK BX	1780560000	C.172	SL-SMT 5.08/23/180 1.5SN BK BX	1775812001	C.174	SLD 3.50 V/44/90F 3.2 SN OR BX	1642470000	C.41
SL-SMT 5.08/16/180 1.5SN BK BX	1775742001	C.174	SL-SMT 5.08/23/180 3.2SN BK BX	1838190000	C.174	SLD 3.50 V/44/90G 3.2 SN OR BX	1642340000	C.40
SL-SMT 5.08/16/180 3.2SN BK BX	1838120000	C.174	SL-SMT 5.08/23/180F 3.2SN BK BX	1837960000	C.176	SLD 3.50 V/46/180F 3.2 SN OR BX	1891160000	C.43
SL-SMT 5.08/16/180F 3.2SN BK BX	1820640000	C.176	SL-SMT 5.08/23/180G 1.5SN BK BX	1776342001	C.175	SLD 3.50 V/48/180F 3.2 SN OR BX	1641350000	C.43
SL-SMT 5.08/16/180G 1.5SN BK BX	1776272001	C.175	SL-SMT 5.08/23/180G 3.2SN BK BX	1838420000	C.175	SLD 3.50 V/48/90F 3.2 SN OR BX	1642480000	C.41
SL-SMT 5.08/16/180G 3.2SN BK BX	1838350000	C.175	SL-SMT 5.08/23/180LF 1.5SN BK BX	1776582001	C.178	SLD 3.50 V/48/90G 3.2 SN OR BX	1642350000	C.40
SL-SMT 5.08/16/180LF 1.5SN BK BX	1838502001	C.178	SL-SMT 5.08/23/180LF 3.2SN BK BX	1838650000	C.178	SLD 3.50/04/90F 3.2SN OR BX	1633810000	C.39
SL-SMT 5.08/16/180LF 3.2SN BK BX	1838580000	C.178	SL-SMT 5.08/23/90 1.5SN BK BX	1774972001	C.168	SLD 3.50/04/90G 3.2SN OR BX	1633580000	C.38
SL-SMT 5.08/16/90 1.5SN BK BX	1774902001	C.168	SL-SMT 5.08/23/90 3.2SN BK BX	1780160000	C.168	SLD 3.50/06/90F 3.2SN OR BX	1633820000	C.39
SL-SMT 5.08/16/90 3.2SN BK BX	1780090000	C.168	SL-SMT 5.08/23/90F 3.2SN BK BX	1837840000	C.170	SLD 3.50/06/90G 3.2SN OR BX	1633590000	C.38
SL-SMT 5.08/16/90F 3.2SN BK BX	1837770000	C.170	SL-SMT 5.08/23/90G 1.5SN BK BX	1775212001	C.169	SLD 3.50/08/90F 3.2SN OR BX	1633830000	C.39
SL-SMT 5.08/16/90G 1.5SN BK BX	1775142001	C.169	SL-SMT 5.08/23/90G 3.2SN BK BX	1780390000	C.169	SLD 3.50/08/90G 3.2SN OR BX	1633600000	C.38
SL-SMT 5.08/16/90G 3.2SN BK BX	1780320000	C.169	SL-SMT 5.08/23/90LF 1.5SN BK BX	1775442001	C.172	SLD 3.50/10/90F 3.2SN OR BX	1633840000	C.39
SL-SMT 5.08/16/90LF 1.5SN BK BX	1775372001	C.172	SL-SMT 5.08/23/90LF 3.2SN BK BX	1780640000	C.172	SLD 3.50/10/90G 3.2SN OR BX	1633610000	C.38
SL-SMT 5.08/16/90LF 3.2SN BK BX	1780570000	C.172	SL-SMT 5.08/24/180 1.5SN BK BX	1775822001	C.174	SLD 3.50/12/90F 3.2SN OR BX	1633850000	C.39
SL-SMT 5.08/17/180 1.5SN BK BX	1775520001	C.174	SL-SMT 5.08/24/180 3.2SN BK BX	1838200000	C.174	SLD 3.50/12/90G 3.2SN OR BX	1633620000	C.38
SL-SMT 5.08/17/180 3.2SN BK BX	1838130000	C.174	SL-SMT 5.08/24/180F 3.2SN BK BX	1837970000	C.176	SLD 3.50/14/90F 3.2SN OR BX	1633860000	C.39
SL-SMT 5.08/17/180F 3.2SN BK BX	1837920000	C.176	SL-SMT 5.08/24/180G 1.5SN BK BX	1776352001	C.175	SLD 3.50/14/90G 3.2SN OR BX	1633630000	C.38
SL-SMT 5.08/17/180G 1.5SN BK BX	1837820001	C.175	SL-SMT 5.08/24/180G 3.2SN BK BX	1838430000	C.175	SLD 3.50/16/90F 3.2SN OR BX	1633870000	C.39
SL-SMT 5.08/17/180G 3.2SN BK BX	1838360000	C.175	SL-SMT 5.08/24/180LF 1.5SN BK BX	1776592001	C.178	SLD 3.50/16/90G 3.2SN OR BX	1633640000	C.38
SL-SMT 5.08/17/180LF 1.5SN BK BX	1776512001	C.178	SL-SMT 5.08/24/180LF 3.2SN BK BX	1838660000	C.178	SLD 3.50/18/90F 3.2SN OR BX	1633880000	C.39
SL-SMT 5.08/17/180LF 3.2SN BK BX	1838590000	C.178	SL-SMT 5.08/24/90 1.5SN BK BX	1774982001	C.168	SLD 3.50/18/90G 3.2SN OR BX	1633650000	C.38
SL-SMT 5.08/17/90 1.5SN BK BX	1774912001	C.168	SL-SMT 5.08/24/90 3.2SN BK BX	1780170000	C.168	SLD 3.50/20/90F 3.2SN OR BX	1633890000	C.39
SL-SMT 5.08/17/90 3.2SN BK BX	1780100000	C.168	SL-SMT 5.08/24/90F 3.2SN BK BX	1837850000	C.170	SLD 3.50/20/90G 3.2SN OR BX	1633660000	C.38
SL-SMT 5.08/17/90F 3.2SN BK BX	1837780000	C.170	SL-SMT 5.08/24/90G 1.5SN BK BX	1775222001	C.169	SLD 3.50/22/90F 3.2SN OR BX	1633900000	C.39
SL-SMT 5.08/17/90G 1.5SN BK BX	1775152001	C.169	SL-SMT 5.08/24/90G 3.2SN BK BX	1780400000	C.169	SLD 3.50/22/90G 3.2SN OR BX	1633670000	C.38
SL-SMT 5.08/17/90G 3.2SN BK BX	1780330000	C.169	SL-SMT 5.08/24/90LF 1.5SN BK BX	1775452001	C.172	SLD 3.50/24/90F 3.2SN OR BX	1633910000	C.39
SL-SMT 5.08/17/90LF 1.5SN BK BX	1775382001	C.172	SL-SMT 5.08/24/90LF 3.2SN BK BX	1780650000	C.172	SLD 3.50/24/90G 3.2SN OR BX	1633680000	C.38
SL-SMT 5.08/17/90LF 3.2SN BK BX	1780580000	C.172	SLA BB11R OR	1604120000	D.6	SLD 3.50/26/90F 3.2SN OR BX	1633920000	C.39
SL-SMT 5.08/18/180 1.5SN BK BX	1775762001	C.174	SLA BB11R SW	1692340000	D.6	SLD 3.50/26/90G 3.2SN OR BX	1633690000	C.38
SL-SMT 5.08/18/180 3.2SN BK BX	1838140000	C.174	SLA BB12R OR	1593450000	D.6	SLD 3.50/28/90F 3.2SN OR BX	1633930000	C.39
SL-SMT 5.08/18/180F 3.2SN BK BX	1820650000	C.176	SLA BB12R SW	1626880000	D.6	SLD 3.50/28/90G 3.2SN OR BX	1633700000	C.38
SL-SMT 5.08/18/180G 1.5SN BK BX	1776292001	C.175	SLA BB14 OR	1594200000	D.7	SLD 3.50/30/90F 3.2SN OR BX	1633940000	C.39
SL-SMT 5.08/18/180G 3.2SN BK BX	1838370000	C.175	SLA BB14 SW	1774460000	D.7	SLD 3.50/30/90G 3.2SN OR BX	1633710000	C.38
SL-SMT 5.08/18/180LF 1.5SN BK BX	1776522001	C.178	SLA BB1R OR	1723430000	D.6	SLD 3.50/32/90F 3.2SN OR BX	1633950000	C.39
SL-SMT 5.08/18/180LF 3.2SN BK BX	1838600000	C.178	SLA BB1R SW	1723480000	D.6	SLD 3.50/32/90G 3.2SN OR BX	1633720000	C.38
SL-SMT 5.08/18/90 1.5SN BK BX	1774922001	C.168	SLA BB2R OR	1723440000	D.6	SLD 3.50/34/90F 3.2SN OR BX	1633960000	C.39
SL-SMT 5.08/18/90 3.2SN BK BX	1780110000	C.168	SLA BB2R SW	1723490000	D.6	SLD 3.50/34/90G 3.2SN OR BX	1633730000	C.38
SL-SMT 5.08/18/90F 3.2SN BK BX	1837790000	C.170	SLA BB4 OR	1571720000	C.212	SLD 3.50/36/90F 3.2SN OR BX	1633970000	C.39
SL-SMT 5.08/18/90G 1.5SN BK BX	1775162001	C.169	SLA BB8 RH OR	1446060000	C.212	SLD 3.50/36/90G 3.2SN OR BX	1633740000	C.38
SL-SMT 5.08/18/90G 3.2SN BK BX	1780340000	C.169	SLD 3.5 V/06/180G 3.2 SN OR	1891190000	C.42	SLD 3.50/38/90F 3.2SN OR BX	1633980000	C.39
SL-SMT 5.08/18/90LF 1.5SN BK BX	1775392001	C.172	SLD 3.5 V/10/180G 3.2 SN OR	1891200000	C.42	SLD 3.50/38/90G 3.2SN OR BX	1633750000	C.38
SL-SMT 5.08/18/90LF 3.2SN BK BX	1780590000	C.172	SLD 3.5 V/12/180G 3.2OR	1641130000	C.42	SLD 3.50/40/90F 3.2SN OR BX	1633990000	C.39
SL-SMT 5.08/19/180 1.5SN BK BX	1775772001	C.174	SLD 3.5 V/16/180G 3.2OR	1641140000	C.42	SLD 3.50/40/90G 3.2SN OR BX	1633760000	C.38
SL-SMT 5.08/19/180 3.2SN BK BX	1838150000	C.174	SLD 3.5 V/20/180G 3.2OR	1641150000	C.42	SLD 3.50/42/90F 3.2SN OR BX	1634000000	C.39
SL-SMT 5.08/19/180F 3.2SN BK BX	1837930000	C.176	SLD 3.5 V/24/180G 3.2OR	1641160000	C.42	SLD 3.50/42/90G 3.2SN OR BX	1633770000	C.38
SL-SMT 5.08/19/180G 1.5SN BK BX	1776320001	C.175	SLD 3.5 V/28/180G 3.2OR	1641170000	C.42	SLD 3.50/44/90F 3.2SN OR BX	1634010000	C.39
SL-SMT 5.08/19/180G 3.2SN BK BX	1838380000	C.175	SLD 3.5 V/32/180G 3.2OR	1641180000	C.42	SLD 3.50/44/90G 3.2SN OR BX	1633780000	C.38
SL-SMT 5.08/19/180LF 1.5SN BK BX	1776532001	C.178	SLD 3.5 V/34/180G 3.2 SN OR	1891260000	C.42	SLD 3.50/46/90F 3.2SN OR BX	1634020000	C.39
SL-SMT 5.08/19/180LF 3.2SN BK BX	1838610000	C.178	SLD 3.5 V/36/180G 3.2OR	1641190000	C.42	SLD 3.50/46/90G 3.2SN OR BX	1633790000	C.38
SL-SMT 5.08/19/90 1.5SN BK BX	1774932001	C.168	SLD 3.5 V/38/180G 3.2 SN OR	1891270000	C.42	SLD 3.50/48/90F 3.2SN OR BX	1634030000	C.39
SL-SMT 5.08/19/90 3.2SN BK BX	1801200000	C.168	SLD 3.5 V/4/180G 3.2OR	1641110000	C.42	SLD 3.50/48/90G 3.2SN OR BX	1633800000	C.38
SL-SMT 5.08/19/90F 3.2SN BK BX	1837800000	C.170	SLD 3.5 V/40/180G 3.2OR	1641200000	C.42	SLD 3.50V/06/90F 3.2SN OR BX	1890790000	C.41
SL-SMT 5.08/19/90G 1.5SN BK BX	1775172001	C.169	SLD 3.5 V/42/180G 3.2 SN OR	1891280000	C.42	SLD 3.50V/06/90G 3.2SN OR BX	1890600000	C.40
SL-SMT 5.08/19/90G 3.2SN BK BX	1780350000	C.169	SLD 3.5 V/44/180G 3.2OR	1641210000	C.42	SLD 3.50V/10/90F 3.2SN OR BX	1890800000	C.41
SL-SMT 5.08/19/90LF 1.5SN BK BX	1775402001	C.172	SLD 3.5 V/46/180G 3.2 SN OR	1891290000	C.42	SLD 3.50V/10/90G 3.2SN OR BX	1866770000	C.40
SL-SMT 5.08/19/90LF 3.2SN BK BX	1780600000	C.172	SLD 3.5 V/48/180G 3.2OR	1641220000	C.42	SLD 3.50V/14/90F 3.2SN OR BX	1890810000	C.41
SL-SMT 5.08/20/180 1.5SN BK BX	1775782001	C.174	SLD 3.5 V/8/180G 3.2OR	1641120000	C.42	SLD 3.50V/14/90G 3.2SN OR BX	1890610000	C.40
SL-SMT 5.08/20/180 3.2SN BK BX	1838160000	C.174	SLD 3.50 V/04/180F 3.2 SN OR BX	1641240000	C.43	SLD 3.50V/18/90F 3.2SN OR BX	1890820000	C.41
SL-SMT 5.08/20/180F 3.2SN BK BX	1820810000	C.176	SLD 3.50 V/04/90F 3.2 SN OR BX	1642370000	C.41	SLD 3.50V/18/90G 3.2SN OR BX	1890620000	C.40
SL-SMT 5.08/20/180G 1.5SN BK BX	1776312001	C.175	SLD 3.50 V/04/90G 3.2 SN OR BX	1642240000	C.40			

Type	Order No.	Page
SLS 5.08/15/180FI SN DR BX	1846340000	C.211
SLS 5.08/16/180B SN DR BX	1627380000	C.210
SLS 5.08/16/180F SN DR BX	1846500000	C.211
SLS 5.08/16/180FI SN DR BX	1846350000	C.211
SLS 5.08/16/180TB KF SN DR BX	1846180000	C.213
SLS 5.08/16/180TB RF15 SN DR BX	1846100000	C.212
SLS 5.08/17/180B SN DR BX	1645150000	C.210
SLS 5.08/18/180B SN DR BX	1645160000	C.210
SLS 5.08/19/180B SN DR BX	1645170000	C.210
SLS 5.08/20/180B SN DR BX	1645180000	C.210
SLS 5.08/20/180TB KF SN DR BX	1846190000	C.213
SLS 5.08/20/180TB RF15 SN DR BX	1846110000	C.212
SLS 5.08/21/180B SN DR BX	1645190000	C.210
SLS 5.08/22/180B SN DR BX	1645200000	C.210
SLS 5.08/23/180B SN DR BX	1645210000	C.210
SLS 5.08/24/180B SN DR BX	1645220000	C.210
SLS 5.08/24/180TB KF SN DR BX	1846200000	C.213
SLS 5.08/24/180TB RF15 SN DR BX	1846120000	C.212
SLT 5.08/02/180B SN DR BX	1611710000	C.214
SLT 5.08/02/180DF SN DR BX	1353350000	C.206
SLT 5.08/03/180B SN DR BX	1611720000	C.214
SLT 5.08/03/180DF SN DR BX	1353370000	C.206
SLT 5.08/04/180B SN DR BX	1611730000	C.214
SLT 5.08/04/180DF SN DR BX	1353380000	C.206
SLT 5.08/05/180B SN DR BX	1611740000	C.214
SLT 5.08/05/180DF SN DR BX	1353390000	C.206
SLT 5.08/06/180B SN DR BX	1611750000	C.214
SLT 5.08/06/180DF SN DR BX	1353400000	C.206
SLT 5.08/07/180B SN DR BX	1611760000	C.214
SLT 5.08/07/180DF SN DR BX	1353420000	C.206
SLT 5.08/08/180B SN DR BX	1611770000	C.214
SLT 5.08/08/180DF SN DR BX	1353430000	C.206
SLT 5.08/09/180B SN DR BX	1611780000	C.214
SLT 5.08/09/180DF SN DR BX	1353440000	C.206
SLT 5.08/10/180B SN DR BX	1611790000	C.214
SLT 5.08/10/180DF SN DR BX	1353450000	C.206
SLT 5.08/11/180B SN DR BX	1611800000	C.214
SLT 5.08/12/180B SN DR BX	1611810000	C.214
SLT 5.08/13/180B SN DR BX	1611820000	C.214
SLT 5.08/14/180B SN DR BX	1611830000	C.214
SLT 5.08/15/180B SN DR BX	1611840000	C.214
SLT 5.08/16/180B SN DR BX	1611850000	C.214
SLZ 7.62HP/02/180F SN BK BX	1043430000	F.13
SLZ 7.62HP/02/180G SN BK BX	1043350000	F.12
SLZ 7.62HP/02/180LR SN BK BX	1043351000	F.13
SLZ 7.62HP/03/180F SN BK BX	1043440000	F.13
SLZ 7.62HP/03/180G SN BK BX	1043360000	F.12
SLZ 7.62HP/03/180LR SN BK BX	1043520000	F.13
SLZ 7.62HP/04/180F SN BK BX	1043450000	F.13
SLZ 7.62HP/04/180G SN BK BX	1043370000	F.12
SLZ 7.62HP/04/180LR SN BK BX	1043530000	F.13
SLZ 7.62HP/05/180F SN BK BX	1043460000	F.13
SLZ 7.62HP/05/180G SN BK BX	1043380000	F.12
SLZ 7.62HP/05/180LR SN BK BX	1043540000	F.13
SMSE 1 MSD ZB	4080540000	I.38
SMSE FE MCZ 1.5/PE	1003280000	I.39
SMSE FE MSA	2279350000	I.38
SMSE KU FE MCZ 1.5	2243900000	I.39
SMSE LN FE MCZ 1.5	2243800000	I.39
SMSE MSA ZB	4286820000	I.38
SMSE2 ZF MSD	2277000000	I.38
SR-SMD 4.50/05/90 AU BK BX	1155840000	I.34
SR-SMD 4.50/05/90LF 1.5AU BK BX	1155890000	I.35
SR-SMD 4.50/05/90LFM 3.2AU BK BX	1155870000	I.35
SU 10.16HP/02/180F 3.5AG BK BX	1813650000	F.83
SU 10.16HP/02/180G 3.5AG BK BX	1813410000	F.82
SU 10.16HP/02/180SF 3.5AG BK BX	1850880000	F.83
SU 10.16HP/02/270F 3.5AG BK BX	1813730000	F.85
SU 10.16HP/02/270G 3.5AG BK BX	1813490000	F.84
SU 10.16HP/02/270SF 3.5AG BK BX	1851120000	F.85
SU 10.16HP/02/90F 3.5AG BK BX	1813570000	F.81
SU 10.16HP/02/90G 3.5AG BK BX	1813330000	F.80
SU 10.16HP/02/90SF 3.5AG BK BX	1851040000	F.81
SU 10.16HP/03/180F 3.5AG BK BX	1813660000	F.83
SU 10.16HP/03/180G 3.5AG BK BX	1813420000	F.82
SU 10.16HP/03/180SF 3.5AG BK BX	1850890000	F.83
SU 10.16HP/03/270F 3.5AG BK BX	1813740000	F.85
SU 10.16HP/03/270G 3.5AG BK BX	1813500000	F.84
SU 10.16HP/03/270SF 3.5AG BK BX	1851130000	F.85
SU 10.16HP/03/90F 3.5AG BK BX	1813580000	F.81
SU 10.16HP/03/90G 3.5AG BK BX	1813340000	F.80
SU 10.16HP/03/90SF 3.5AG BK BX	1851050000	F.81
SU 10.16HP/04/180F 3.5AG BK BX	1813670000	F.83
SU 10.16HP/04/180G 3.5AG BK BX	1813430000	F.82
SU 10.16HP/04/180SF 3.5AG BK BX	1850900000	F.83
SU 10.16HP/04/270F 3.5AG BK BX	1813750000	F.85
SU 10.16HP/04/270G 3.5AG BK BX	1813510000	F.84
SU 10.16HP/04/270SF 3.5AG BK BX	1851140000	F.85
SU 10.16HP/04/90F 3.5AG BK BX	1813590000	F.81
SU 10.16HP/04/90G 3.5AG BK BX	1813350000	F.80
SU 10.16HP/04/90SF 3.5AG BK BX	1851060000	F.81
SU 10.16HP/05/180F 3.5AG BK BX	1813680000	F.83
SU 10.16HP/05/180G 3.5AG BK BX	1813440000	F.82
SU 10.16HP/05/180SF 3.5AG BK BX	1850910000	F.83
SU 10.16HP/05/270F 3.5AG BK BX	1813760000	F.85
SU 10.16HP/05/270G 3.5AG BK BX	1813520000	F.84
SU 10.16HP/05/270SF 3.5AG BK BX	1851150000	F.85
SU 10.16HP/05/90F 3.5AG BK BX	1813600000	F.81
SU 10.16HP/05/90G 3.5AG BK BX	1813360000	F.80

Type	Order No.	Page
SU 10.16HP/05/90SF 3.5AG BK BX	1851070000	F.81
SU 10.16HP/06/180F 3.5AG BK BX	1813690000	F.83
SU 10.16HP/06/180G 3.5AG BK BX	1813450000	F.82
SU 10.16HP/06/180SF 3.5AG BK BX	1850920000	F.83
SU 10.16HP/06/270F 3.5AG BK BX	1813770000	F.85
SU 10.16HP/06/270G 3.5AG BK BX	1813530000	F.84
SU 10.16HP/06/270SF 3.5AG BK BX	1851160000	F.85
SU 10.16HP/06/90F 3.5AG BK BX	1813610000	F.81
SU 10.16HP/06/90G 3.5AG BK BX	1813370000	F.80
SU 10.16HP/06/90SF 3.5AG BK BX	1851080000	F.81
SU 10.16HP/07/180F 3.5AG BK BX	1813700000	F.83
SU 10.16HP/07/180G 3.5AG BK BX	1813460000	F.82
SU 10.16HP/07/180SF 3.5AG BK BX	1850930000	F.83
SU 10.16HP/07/270F 3.5AG BK BX	1813780000	F.85
SU 10.16HP/07/270G 3.5AG BK BX	1813540000	F.84
SU 10.16HP/07/270SF 3.5AG BK BX	1851170000	F.85
SU 10.16HP/07/90F 3.5AG BK BX	1813620000	F.81
SU 10.16HP/07/90G 3.5AG BK BX	1813380000	F.80
SU 10.16HP/07/90SF 3.5AG BK BX	1851090000	F.81
SU 10.16HP/08/180F 3.5AG BK BX	1813710000	F.83
SU 10.16HP/08/180G 3.5AG BK BX	1813470000	F.82
SU 10.16HP/08/180SF 3.5AG BK BX	1850940000	F.83
SU 10.16HP/08/270F 3.5AG BK BX	1813790000	F.85
SU 10.16HP/08/270G 3.5AG BK BX	1813550000	F.84
SU 10.16HP/08/270SF 3.5AG BK BX	1851180000	F.85
SU 10.16HP/08/90F 3.5AG BK BX	1813630000	F.81
SU 10.16HP/08/90G 3.5AG BK BX	1813390000	F.80
SU 10.16HP/08/90SF 3.5AG BK BX	1851100000	F.81
SU 10.16HP/09/180F 3.5AG BK BX	1813720000	F.83
SU 10.16HP/09/180G 3.5AG BK BX	1813480000	F.82
SU 10.16HP/09/180SF 3.5AG BK BX	1850950000	F.83
SU 10.16HP/09/270F 3.5AG BK BX	1813800000	F.85
SU 10.16HP/09/270G 3.5AG BK BX	1813560000	F.84
SU 10.16HP/09/270SF 3.5AG BK BX	1851190000	F.85
SU 10.16HP/09/90F 3.5AG BK BX	1813640000	F.81
SU 10.16HP/09/90G 3.5AG BK BX	1813400000	F.80
SU 10.16HP/09/90SF 3.5AG BK BX	1851110000	F.81
SU 10.16IT/02/270MF2 3.5AG BK BX SO	1157310000	F.106
SU 10.16IT/02/90MF2 3.5AG BK BX	1157320000	F.108
SU 10.16IT/03/270MF3 3.5AG BK BX	1157330000	F.109
SU 10.16IT/03/90MF3 3.5AG BK BX	1156680000	F.107
SU 10.16IT/04/270MF4 3.5AG BK BX	1157340000	F.108
SU 10.16IT/04/90MF4 3.5AG BK BX	1157350000	F.109
SU 10.16IT/05/270MF5 3.5AG BK BX	1157360000	F.110
SU 10.16HP/02/180G AG BK BX	1947480000	F.86
SU 10.16HP/03/180G AG BK BX	1947490000	F.86
SU 10.16HP/04/180G AG BK BX	1947500000	F.86
SU 10.16HP/05/180G AG BK BX	1947510000	F.86
SU 10.16HP/06/180G AG BK BX	1966920000	F.86
SU 10.16HP/07/180G AG BK BX	1966930000	F.86
SU 10.16HP/08/180G AG BK BX	1962400000	F.86
SU 10.16HP/09/180G AG BK BX	1966910000	F.86
SV 7.62HP/02/180F 3.5SN BK BX	1930710000	F.31
SV 7.62HP/02/180G 3.5SN BK BX	1930600000	F.30
SV 7.62HP/02/180MF 3.5SN BK BX	1048350000	F.32
SV 7.62HP/02/180SF 3.5SN BK BX	1930820000	F.31
SV 7.62HP/02/270F 3.5SN BK BX	1931370000	F.35
SV 7.62HP/02/270G 3.5SN BK BX	1931260000	F.34
SV 7.62HP/02/270G SC/04R SN BK BX	1090770000	F.118
SV 7.62HP/02/270G SC/06R SN BK BX	1090850000	F.118
SV 7.62HP/02/270G SC/08R SN BK BX	1156920000	F.118
SV 7.62HP/02/270MF 3.5SN BK BX	1048370000	F.36
SV 7.62HP/02/270MF SC/04R SN BK BX	1089260000	F.119
SV 7.62HP/02/270MF SC/06R SN BK BX	1089280000	F.119
SV 7.62HP/02/270MF SC/08R SN BK BX	1156120000	F.119
SV 7.62HP/02/270MSF SC/04R SN BK BX	1089340000	F.119
SV 7.62HP/02/270MSF SC/06R SN BK BX	1089380000	F.119
SV 7.62HP/02/270MSF SC/08R SN BK BX	1156130000	F.119
SV 7.62HP/02/270SF 3.5SN BK BX	1931480000	F.35
SV 7.62HP/02/90F 3.5SN BK BX	1930380000	F.29
SV 7.62HP/02/90G 3.5SN BK BX	1930270000	F.28
SV 7.62HP/02/90G SC/04R SN BK BX	1089840000	F.116
SV 7.62HP/02/90G SC/06R SN BK BX	1089920000	F.116
SV 7.62HP/02/90G SC/08R SN BK BX	1157040000	F.116
SV 7.62HP/02/90MF 3.5SN BK BX	1048390000	F.29
SV 7.62HP/02/90MF SC/04R SN BK BX	1089370000	F.117
SV 7.62HP/02/90MF SC/06R SN BK BX	1089410000	F.117
SV 7.62HP/02/90MF SC/08R SN BK BX	1156820000	F.117
SV 7.62HP/02/90MSF SC/04R SN BK BX	1089510000	F.117
SV 7.62HP/02/90MSF SC/06R SN BK BX	1089570000	F.117
SV 7.62HP/02/90MSF SC/08R SN BK BX	1156830000	F.117
SV 7.62HP/02/90SF 3.5SN BK BX	1930490000	F.29
SV 7.62HP/03/180F 3.5SN BK BX	1930720000	F.31
SV 7.62HP/03/180G 3.5SN BK BX	1930610000	F.30
SV 7.62HP/03/180MF 3.5SN BK BX	1048410000	F.32
SV 7.62HP/03/180SF 3.5SN BK BX	1048420000	F.33
SV 7.62HP/03/180SF 3.5SN BK BX	1930830000	F.31
SV 7.62HP/03/270F 3.5SN BK BX	1931380000	F.35
SV 7.62HP/03/270G 3.5SN BK BX	1931270000	F.34
SV 7.62HP/03/270G SC/04R SN BK BX	1090950000	F.118
SV 7.62HP/03/270G SC/06R SN BK BX	1091010000	F.118
SV 7.62HP/03/270G SC/08R SN BK BX	1156940000	F.118
SV 7.62HP/03/270MF2 3.5SN BK BX	1048450000	F.36
SV 7.62HP/03/270MF2 SC/04R SN BK BX	1156140000	F.119
SV 7.62HP/03/270MF2 SC/06R SN BK BX	1156150000	F.119
SV 7.62HP/03/270MF2 SC/08R SN BK BX	1156170000	F.119

Type	Order No.	Page
SV 7.62HP/03/270MF3 3.5SN BK BX	1048460000	F.37
SV 7.62HP/03/270MF3 SC/04R SN BK BX	1089440000	F.119
SV 7.62HP/03/270MF3 SC/06R SN BK BX	1089490000	F.119
SV 7.62HP/03/270MF3 SC/08R SN BK BX	1156180000	F.119
SV 7.62HP/03/270MSF2 SC/04R SN BK BX	1156190000	F.119
SV 7.62HP/03/270MSF2 SC/06R SN BK BX	1156200000	F.119
SV 7.62HP/03/270MSF2 SC/08R SN BK BX	1156210000	F.119
SV 7.62HP/03/270MSF3 SC/04R SN BK BX	1089610000	F.119
SV 7.62HP/03/270MSF3 SC/06R SN BK BX	1089670000	F.119
SV 7.62HP/03/270MSF3 SC/08R SN BK BX	1156220000	F.119
SV 7.62HP/03/270SF 3.5SN BK BX	1931490000	F.35
SV 7.62HP/03/90F 3.5SN BK BX	1930390000	F.29
SV 7.62HP/03/90G 3.5SN BK BX	1930280000	F.28
SV 7.62HP/03/90G SC/04R SN BK BX	1090040000	F.116
SV 7.62HP/03/90G SC/06R SN BK BX	1090120000	F.116
SV 7.62HP/03/90G SC/08R SN BK BX	1157050000	F.116
SV 7.62HP/03/90MF2 3.5SN BK BX	1048490000	F.29
SV 7.62HP/03/90MF2 SC/04R SN BK BX	1156230000	F.117
SV 7.62HP/03/90MF2 SC/06R SN BK BX	1156240000	F.117
SV 7.62HP/03/90MF2 SC/08R SN BK BX	1156840000	F.117
SV 7.62HP/03/90MF3 3.5SN BK BX	1048500000	F.29
SV 7.62HP/03/90MF3 SC/04R SN BK BX	1089660000	F.117
SV 7.62HP/03/90MF3 SC/06R SN BK BX	1089730000	F.117
SV 7.62HP/03/90MF3 SC/08R SN BK BX	1156850000	F.117
SV 7.62HP/03/90MSF2 SC/04R SN BK BX	1156250000	F.117
SV 7.62HP/03/90MSF2 SC/06R SN BK BX	1156270000	F.117
SV 7.62HP/03/90MSF2 SC/08R SN BK BX	1156870000	F.117
SV 7.62HP/03/90MSF3 SC/04R SN BK BX	1089890000	F.117
SV		

Type	Order No.	Page
SV 7.62HP/05/90MSF3 SC/04R SN BK BX	1157000000	F.117
SV 7.62HP/05/90MSF3 SC/08R SN BK BX	1157010000	F.117
SV 7.62HP/05/90MSF3 SC/08R SN BK BX	1157020000	F.117
SV 7.62HP/05/90MSF4 SC/04R SN BK BX	1090830000	F.117
SV 7.62HP/05/90MSF4 SC/08R SN BK BX	1090900000	F.117
SV 7.62HP/05/90MSF4 SC/08R SN BK BX	1157030000	F.117
SV 7.62HP/05/90SF 3.5SN BK BX	1930520000	F.29
SV 7.62HP/06/180F 3.5SN BK BX	1930750000	F.31
SV 7.62HP/06/180G 3.5SN BK BX	1930640000	F.30
SV 7.62HP/06/180MF 3.5SN BK BX	1048720000	F.33
SV 7.62HP/06/180SF 3.5SN BK BX	1930860000	F.31
SV 7.62HP/06/270F 3.5SN BK BX	1931410000	F.35
SV 7.62HP/06/270G 3.5SN BK BX	1931300000	F.34
SV 7.62HP/06/270MF 3.5SN BK BX	1048740000	F.37
SV 7.62HP/06/270SF 3.5SN BK BX	1931520000	F.35
SV 7.62HP/06/90F 3.5SN BK BX	1930420000	F.29
SV 7.62HP/06/90G 3.5SN BK BX	1930310000	F.28
SV 7.62HP/06/90MF 3.5SN BK BX	1048760000	F.29
SV 7.62HP/06/90SF 3.5SN BK BX	1930530000	F.29
SV 7.62HP/07/180F 3.5SN BK BX	1930760000	F.31
SV 7.62HP/07/180G 3.5SN BK BX	1930650000	F.30
SV 7.62HP/07/180SF 3.5SN BK BX	1930870000	F.31
SV 7.62HP/07/270F 3.5SN BK BX	1931420000	F.35
SV 7.62HP/07/270G 3.5SN BK BX	1931310000	F.34
SV 7.62HP/07/270SF 3.5SN BK BX	1931530000	F.35
SV 7.62HP/07/90F 3.5SN BK BX	1930430000	F.29
SV 7.62HP/07/90G 3.5SN BK BX	1930320000	F.28
SV 7.62HP/07/90SF 3.5SN BK BX	1930540000	F.29
SV 7.62IT/02/270MF2 3.2SN BK BX SO	1156490000	F.102
SV 7.62IT/02/90MF2 3.2SN BK BX SO	1156540000	F.100
SV 7.62IT/03/270MF2 3.2SN BK BX	1156500000	F.102
SV 7.62IT/03/270MF3 3.2SN BK BX	1156510000	F.103
SV 7.62IT/03/90MF2 3.2SN BK BX	1156550000	F.100
SV 7.62IT/03/90MF3 3.2SN BK BX	1156570000	F.101
SV 7.62IT/04/270MF2 3.2SN BK BX	1156520000	F.102
SV 7.62IT/04/270MF4 3.2SN BK BX	1156530000	F.103
SV 7.62IT/04/90MF2 3.2SN BK BX	1156580000	F.100
SV 7.62IT/04/90MF4 3.2SN BK BX	1156590000	F.101
SVF 7.62HP/02/180F SN BK BX	1060900000	F.51
SVF 7.62HP/02/180FI SN BK BX	1247500000	F.52
SVF 7.62HP/02/180G SN BK BX	1060830000	F.50
SVF 7.62HP/02/180MF SN BK BX	1061020000	F.54
SVF 7.62HP/02/180SF SN BK BX	1061110000	F.56
SVF 7.62HP/02/180SF SN BK BX	1060950000	F.51
SVF 7.62HP/02/180SFI SN BK BX	1061200000	F.53
SVF 7.62HP/03/180F SN BK BX	1060910000	F.51
SVF 7.62HP/03/180FI SN BK BX	1124760000	F.52
SVF 7.62HP/03/180G SN BK BX	1060840000	F.50
SVF 7.62HP/03/180MF SN BK BX	1061030000	F.54
SVF 7.62HP/03/180SF SN BK BX	1061040000	F.55
SVF 7.62HP/03/180SF2 SN BK BX	1061120000	F.56
SVF 7.62HP/03/180MSF3 SN BK BX	1061130000	F.57
SVF 7.62HP/03/180SF SN BK BX	1060970000	F.51
SVF 7.62HP/03/180SFI SN BK BX	1124820000	F.53
SVF 7.62HP/04/180F SN BK BX	1060920000	F.51
SVF 7.62HP/04/180FI SN BK BX	1124770000	F.52
SVF 7.62HP/04/180G SN BK BX	1060850000	F.50
SVF 7.62HP/04/180MF SN BK BX	1061050000	F.55
SVF 7.62HP/04/180SF SN BK BX	1061140000	F.57
SVF 7.62HP/04/180SF SN BK BX	1060980000	F.51
SVF 7.62HP/04/180SFI SN BK BX	1124830000	F.53
SVF 7.62HP/05/180F SN BK BX	1060930000	F.51
SVF 7.62HP/05/180FI SN BK BX	1124780000	F.52
SVF 7.62HP/05/180G SN BK BX	1060870000	F.50
SVF 7.62HP/05/180MF SN BK BX	1061070000	F.55
SVF 7.62HP/05/180SF SN BK BX	1061080000	F.56
SVF 7.62HP/05/180SF3 SN BK BX	1061150000	F.57
SVF 7.62HP/05/180SF4 SN BK BX	1061170000	F.57
SVF 7.62HP/05/180SF SN BK BX	1061000000	F.51
SVF 7.62HP/05/180SFI SN BK BX	1124840000	F.53
SVF 7.62HP/06/180G SN BK BX	1060880000	F.50
SVZ 7.62HP/02/180F SN BK BX	1931740000	F.39
SVZ 7.62HP/02/180FC SN BK BX	1950880000	F.40
SVZ 7.62HP/02/180FI SN BK BX	1932070000	F.42
SVZ 7.62HP/02/180G SN BK BX	1931620000	F.38
SVZ 7.62HP/02/180SF SN BK BX	1931960000	F.39
SVZ 7.62HP/02/180SFC SN BK BX	1950990000	F.41
SVZ 7.62HP/02/180SFI SN BK BX	1932180000	F.43
SVZ 7.62HP/03/180F SN BK BX	1931760000	F.39
SVZ 7.62HP/03/180FC SN BK BX	1950890000	F.40
SVZ 7.62HP/03/180FI SN BK BX	1932080000	F.42
SVZ 7.62HP/03/180G SN BK BX	1931630000	F.38
SVZ 7.62HP/03/180SF SN BK BX	1931970000	F.39
SVZ 7.62HP/03/180SFC SN BK BX	1951000000	F.41
SVZ 7.62HP/03/180SFI SN BK BX	1932190000	F.43
SVZ 7.62HP/03/180SH150I SN BK BX	1932330000	F.48
SVZ 7.62HP/03/180SH180 SN BK BX	1932460000	F.44
SVZ 7.62HP/03/180SH180C SN BK BX	1951150000	F.46
SVZ 7.62HP/03/180SH180I SN BK BX	1932500000	F.49
SVZ 7.62HP/03/180SH210I SN BK BX	1932500000	F.49
SVZ 7.62HP/03/180SH210I SN BK BX	1932580000	F.49
SVZ 7.62HP/04/180F SN BK BX	1931820000	F.39
SVZ 7.62HP/04/180FC SN BK BX	1950900000	F.40
SVZ 7.62HP/04/180FI SN BK BX	1932090000	F.42
SVZ 7.62HP/04/180G SN BK BX	1931640000	F.38
SVZ 7.62HP/04/180SF SN BK BX	1931980000	F.39
SVZ 7.62HP/04/180SFC SN BK BX	1951010000	F.41
SVZ 7.62HP/04/180SFI SN BK BX	1932200000	F.43
SVZ 7.62HP/04/180SH150I SN BK BX	1932400000	F.48
SVZ 7.62HP/04/180SH180 SN BK BX	1932470000	F.44

Type	Order No.	Page
SVZ 7.62HP/04/180SH180C SN BK BX	1951160000	F.46
SVZ 7.62HP/04/180SH180I SN BK BX	1932510000	F.49
SVZ 7.62HP/04/180SH210I SN BK BX	1932590000	F.49
SVZ 7.62HP/05/180F SN BK BX	1931840000	F.39
SVZ 7.62HP/05/180FC SN BK BX	1950910000	F.40
SVZ 7.62HP/05/180FI SN BK BX	1932100000	F.42
SVZ 7.62HP/05/180G SN BK BX	1931660000	F.38
SVZ 7.62HP/05/180SF SN BK BX	1931990000	F.39
SVZ 7.62HP/05/180SFC SN BK BX	1951020000	F.41
SVZ 7.62HP/05/180SFI SN BK BX	1932210000	F.43
SVZ 7.62HP/05/180SH150I SN BK BX	1932350000	F.48
SVZ 7.62HP/05/180SH180 SN BK BX	1932480000	F.44
SVZ 7.62HP/05/180SH180C SN BK BX	1951170000	F.46
SVZ 7.62HP/05/180SH180I SN BK BX	1932520000	F.49
SVZ 7.62HP/05/180SH210I SN BK BX	1932600000	F.49
SVZ 7.62HP/06/180F SN BK BX	1931850000	F.39
SVZ 7.62HP/06/180FC SN BK BX	1950920000	F.40
SVZ 7.62HP/06/180FI SN BK BX	1932110000	F.42
SVZ 7.62HP/06/180G SN BK BX	1931700000	F.38
SVZ 7.62HP/06/180SF SN BK BX	1932000000	F.39
SVZ 7.62HP/06/180SFC SN BK BX	1951030000	F.41
SVZ 7.62HP/06/180SFI SN BK BX	1932220000	F.43
SVZ 7.62HP/06/180SH150I SN BK BX	1932360000	F.48
SVZ 7.62HP/06/180SH180 SN BK BX	1932490000	F.44
SVZ 7.62HP/06/180SH180C SN BK BX	1951180000	F.46
SVZ 7.62HP/06/180SH180I SN BK BX	1932530000	F.49
SVZ 7.62HP/06/180SH210I SN BK BX	1932610000	F.49
SVZ 7.62HP/07/180F SN BK BX	1931860000	F.39
SVZ 7.62HP/07/180FC SN BK BX	1950930000	F.40
SVZ 7.62HP/07/180FI SN BK BX	1932120000	F.42
SVZ 7.62HP/07/180G SN BK BX	1931680000	F.38
SVZ 7.62HP/07/180SF SN BK BX	1932010000	F.39
SVZ 7.62HP/07/180SFC SN BK BX	1951050000	F.41
SVZ 7.62HP/07/180SFI SN BK BX	1932230000	F.43

T

TOP1.5GS BB OR	1539860000	D.7
TOP1.5GS10/180 5 2ST OR	0570560000	B.47
TOP1.5GS10/180 7 2ST OR	0571160000	B.49
TOP1.5GS10/90 5 2STI OR	0642280000	B.46
TOP1.5GS10/90 7 2STI OR	0642580000	B.48
TOP1.5GS11/180 5 2ST OR	1474760000	B.47
TOP1.5GS11/180 7 2ST OR	1597090000	B.49
TOP1.5GS11/90 5 2STI OR	0594260000	B.46
TOP1.5GS11/90 7 2STI OR	0394060000	B.48
TOP1.5GS12/180 5 2STI OR	0597960000	B.47
TOP1.5GS12/180 7 2ST OR	0392160000	B.49
TOP1.5GS12/90 5 2STI OR	0594380000	B.46
TOP1.5GS12/90 7 2STI OR	0394160000	B.48
TOP1.5GS13/180 5 2ST OR	1724740000	B.47
TOP1.5GS13/90 5 2STI OR	0594460000	B.46
TOP1.5GS14/180 5 2STI OR	0598160000	B.47
TOP1.5GS14/90 5 2STI OR	0594560000	B.46
TOP1.5GS15/180 5 2ST OR	1782490000	B.47
TOP1.5GS15/90 5 2STI OR	0594660000	B.46
TOP1.5GS16/180 5 2ST OR	0570760000	B.47
TOP1.5GS16/90 5 2STI OR	0642360000	B.46
TOP1.5GS17/180 5 2ST OR	0598360000	B.47
TOP1.5GS17/90 5 2STI OR	0594760000	B.46
TOP1.5GS18/180 5 2STI OR	0598460000	B.47
TOP1.5GS18/90 5 2STI OR	1707040000	B.46
TOP1.5GS19/180 5 2ST OR	0598560000	B.47
TOP1.5GS19/90 5 2STI OR	0594960000	B.46
TOP1.5GS2/180 5 2STI OR	0569960000	B.47
TOP1.5GS2/180 7 2STI OR	0391360000	B.49
TOP1.5GS2/90 5 2STI OR	0641960000	B.46
TOP1.5GS2/90 7 2STI OR	0393360000	B.48
TOP1.5GS20/180 5 2ST OR	0598660000	B.47
TOP1.5GS20/90 5 2STI OR	0595060000	B.46
TOP1.5GS21/180 5 2ST OR	0598760000	B.47
TOP1.5GS21/90 5 2STI OR	0595160000	B.46
TOP1.5GS22/180 5 2ST OR	0598860000	B.47
TOP1.5GS22/90 5 2STI OR	0595260000	B.46
TOP1.5GS23/180 5 2ST OR	0598960000	B.47
TOP1.5GS23/90 5 2STI OR	0595360000	B.46
TOP1.5GS24/180 5 2ST OR	0599060000	B.47
TOP1.5GS24/90 5 2STI OR	0595460000	B.46
TOP1.5GS3/180 5 2STI OR	0570160000	B.47
TOP1.5GS3/180 7 2STI OR	0391460000	B.49
TOP1.5GS3/90 5 2STI OR	0642060000	B.46
TOP1.5GS3/90 7 2STI OR	0393460000	B.48
TOP1.5GS4/180 5 2STI OR	0570360000	B.47
TOP1.5GS4/180 7 2STI OR	0391560000	B.49
TOP1.5GS4/90 5 2STI OR	0642160000	B.46
TOP1.5GS4/90 7 2STI OR	0393560000	B.48
TOP1.5GS5/180 5 2STI OR	0597360000	B.47
TOP1.5GS5/180 7 2STI OR	1490460000	B.49
TOP1.5GS5/90 5 2STI OR	1578820000	B.46
TOP1.5GS5/90 7 2STI OR	0393660000	B.48
TOP1.5GS6/180 5 2STI OR	0597460000	B.47
TOP1.5GS6/180 7 2STI OR	1597080000	B.49
TOP1.5GS6/90 5 2STI OR	0593860000	B.46
TOP1.5GS6/90 7 2STI OR	1683990000	B.48
TOP1.5GS7/180 5 2STI OR	1695700000	B.47
TOP1.5GS7/180 7 2STI OR	1597070000	B.49
TOP1.5GS7/90 5 2STI OR	0593960000	B.46
TOP1.5GS7/90 7 2STI OR	1647310000	B.48
TOP1.5GS8/180 5 2STI OR	0597660000	B.47

Type	Order No.	Page
TOP1.5GS8/180 7 2STI OR	0570960000	B.49
TOP1.5GS8/90 5 2STI OR	0594060000	B.46
TOP1.5GS8/90 7 2STI OR	0642460000	B.48
TOP1.5GS9/180 5 2STI OR	1474660000	B.47
TOP1.5GS9/180 7 2STI OR	1597080000	B.49
TOP1.5GS9/90 5 2STI OR	0594160000	B.46
TOP1.5GS9/90 7 2STI OR	0393960000	B.48
TOP4GS10/180 6.35 OR	1786270000	B.51
TOP4GS10/180 7.62 OR	1786570000	B.53
TOP4GS10/90 6.35 OR	1786080000	B.50
TOP4GS10/90 7.62 OR	1786440000	B.52
TOP4GS11/180 6.35 OR	1786280000	B.51
TOP4GS11/180 7.62 OR	1786580000	B.53
TOP4GS11/90 6.35 OR	1786090000	B.50
TOP4GS11/90 7.62 OR	1759860000	B.52
TOP4GS12/180 6.35 OR	1786290000	B.51
TOP4GS12/180 7.62 OR	1749170000	B.53
TOP4GS12/90 6.35 OR	1786100000	B.50
TOP4GS12/90 7.62 OR	1786450000	B.52
TOP4GS3/180 6.35 OR	1786200000	B.51
TOP4GS3/180 7.62 OR	1786260000	B.53
TOP4GS3/90 6.35 OR	1786130000	B.51
TOP4GS2/180 6.35 OR	0298360000	B.53
TOP4GS2/90 6.35 OR	1401760000	B.50
TOP4GS2/90 7.62 OR	0289660000	B.52
TOP4GS3/180 6.35 OR	1786200000	B.51
TOP4GS3/180 7.62 OR	0298460000	B.53
TOP4GS3/90 6.35 OR	1650330000	B.50
TOP4GS3/90 7.62 OR	0289760000	B.52
TOP4GS4/180 6.35 OR	1786210000	B.51
TOP4GS4/180 7.62 OR	0298560000	B.53
TOP4GS4/90 6.35 OR	1786030000	B.50
TOP4GS4/90 7.62 OR	0290160000	B.52
TOP4GS5/180 6.35 OR	1786220000	B.51
TOP4GS5/180 7.62 OR	1786540000	B.53
TOP4GS5/90 6.35 OR	1786040000	B.50
TOP4GS5/90 7.62 OR	1698740000	B.52
TOP4GS6/180 6.35 OR	1786230000	B.51
TOP4GS6/180 7.62 OR	1494560000	B.53
TOP4GS6/90 6.35 OR	1786050000	B.50
TOP4GS6/90 7.62 OR	1786410000	B.52
TOP4GS7/180 6.35 OR	1786240000	B.51
TOP4GS7/180 7.62 OR	1786550000	B.53
TOP4GS7/90 6.35 OR	1786060000	B.50
TOP4GS7/90 7.62 OR	1647	

Type	Order No.	Page
WGK 25/Z SW	1250810000	G.11
WGK 4	1936550000	G.8
WGK 4 GN/YE	1936540000	G.8
WGK 4 SW	1250930000	G.8
WGK 4 VP	1981890000	G.9
WGK 4 VP BK	1339790000	G.9
WGK 4 VP GN/YE	1003890000	G.9
WGK 4 VP/Z	1003910000	G.9
WGK 4 VP/Z BK	1339810000	G.9
WGK 4 VP/Z GN/YE	1003900000	G.9
WGK 4/Z	1936570000	G.8
WGK 4/Z gn/ye	1936560000	G.8
WGK 4/Z SW	1250940000	G.8
WGK 50	1937090000	G.13
WGK 50 GN/YE	1937040000	G.13
WGK 50 SW	1250730000	G.13
WGK 50 VP	1937060000	G.13
WGK 50 VP GN/YE	1937050000	G.13
WGK 50 VP SW	1250710000	G.13
WGK 50 VP/Z	1937080000	G.13
WGK 50 VP/Z GN/YE	1937070000	G.13
WGK 50 VP/Z SW	1250720000	G.13
WGK 50/Z	1937110000	G.13
WGK 50/Z GN/YE	1937100000	G.13
WGK 50/Z SW	1250740000	G.13
WGK 95	1937380000	G.13
WGK 95 F VP	1937130000	G.14
WGK 95 F VP GN/YE	1937120000	G.14
WGK 95 F VP SW	1250660000	G.14
WGK 95 F VP/Z	1937140000	G.14
WGK 95 F VP/Z GN/YE	1937360000	G.14
WGK 95 F VP/Z SW	1250670000	G.14
WGK 95 GN/YE	1937370000	G.13
WGK 95 SW	1250680000	G.13
WGK 95/Z	1937400000	G.13
WGK 95/Z GN/YE	1937390000	G.13
WGK 95/Z SW	1250690000	G.13
WGKV 10	1934060000	G.9
WGKV 10 gn/ye	1936580000	G.9
WGKV 10 SW	1250910000	G.9
WGKV 10/Z	1936600000	G.9
WGKV 10/Z gn/ye	1936590000	G.9
WGKV 10/Z SW	1250920000	G.9
WGKV 16	1003880000	G.11
WGKV 16 GN/YE	1003950000	G.11
WGKV 16 SW	1250840000	G.11
WGKV 16/Z	1003940000	G.11
WGKV 16/Z GN/YE	1003930000	G.11
WGKV 16/Z SW	1250850000	G.11
WGKV 25	1934070000	G.12
WGKV 25 gn/ye	1936720000	G.12
WGKV 25 SW	1250770000	G.12
WGKV 25/Z	1936750000	G.12
WGKV 25/Z gn/ye	1936740000	G.12
WGKV 25/Z SW	1250780000	G.12
WGKV 4	1934050000	G.8
WGKV 4 gn/ye	1936610000	G.8
WGKV 4 SW	1250950000	G.8
WGKV 4/Z	1936630000	G.8
WGKV 4/Z gn/ye	1936620000	G.8
WGKV 4/Z SW	1250960000	G.8
WS 10/5 MC NEUTRAL	1635000000	D.18
WS 12/5 MC NEUTRAL	1609860000	D.18

Z

ZBSC DLI2 5/M2.5X6	1919670000	I.38
ZQV 4N/2 BL	1793960000	I.38
ZQV 4N/2 GE	1758250000	I.38
ZQV 4N/2 RT	1793950000	I.38
ZW 15 RS OR	0119860000	I.45
ZW 25 RS OR	0126160000	I.45
ZW 30 RS OR	0119960000	I.45
ZW 45 RS OR	0120060000	I.45
ZW 5 RS OR	0119760000	I.45

Order No.	Type	Page
-----------	------	------

011000000

0119560000	RF RS 70 RE/A3/M.BEZ	I.45
0119660000	RF RS 70 LU/A2/0.SG	I.45
0119760000	ZW 5 RS OR	I.45
0119860000	ZW 15 RS OR	I.45
0119960000	ZW 30 RS OR	I.45

012000000

0120060000	ZW 45 RS OR	I.45
0126160000	ZW 25 RS OR	I.45
0126260000	RF RS 70 RE/A4/0.BEZ	I.45

015000000

0157261187	DEK 5 GS PE	D.17
0157261202	DEK 5 GS ERDE	D.17
0157261203	DEK 5 GS ERDE IM KREIS	D.17

021000000

0213760000	RF RS 70 MI/A6	I.45
------------	----------------	------

023000000

0236510000	TS 35X15/LL 1M/ST/ZN	I.35
------------	----------------------	------

028000000

0289660000	TOP4GS2/90 7.62 OR	B.52
0289760000	TOP4GS3/90 7.62 OR	B.52

029000000

0290160000	TOP4GS4/90 7.62 OR	B.52
0298360000	TOP4GS2/180 7.62 OR	B.53
0298460000	TOP4GS3/180 7.62 OR	B.53
0298560000	TOP4GS4/180 7.62 OR	B.53

031000000

0310000000	PS 2.0 MC	B.33
------------	-----------	------

033000000

0331500001	SF 10 BEZ. 1-10	D.18
0331500011	SF 10 BEZ. 11-20	D.18
0332400000	SF 10 BEZ. 0-9	D.18
0332500000	SG 10	D.18
0332500001	SG 10 BEZ. 1	D.18
0332500002	SG 10 BEZ. 2	D.18
0332500003	SG 10 BEZ. 3	D.18
0332500004	SG 10 BEZ. 4	D.18
0332500005	SG 10 BEZ. 5	D.18
0332500006	SG 10 BEZ. 6	D.18
0332500007	SG 10 BEZ. 7	D.18
0332500008	SG 10 BEZ. 8	D.18
0332500009	SG 10 BEZ. 9	D.18

035000000

0354361187	DEK 5 FWZ L1-PE	D.17
------------	-----------------	------

039000000

0391360000	TOP1.5GS2/180 7.2STI OR	B.49
0391460000	TOP1.5GS3/180 7.2STI OR	B.49
0391560000	TOP1.5GS4/180 7.2STI OR	B.49
0392160000	TOP1.5GS12/180 7.2STI OR	B.49
0393360000	TOP1.5GS2/90 7.2STI OR	B.48
0393460000	TOP1.5GS3/90 7.2STI OR	B.48
0393560000	TOP1.5GS4/90 7.2STI OR	B.48
0393660000	TOP1.5GS5/90 7.2STI OR	B.48
0393960000	TOP1.5GS9/90 7.2STI OR	B.48
0394060000	TOP1.5GS11/90 7.2STI OR	B.48
0394160000	TOP1.5GS12/90 7.2STI OR	B.48

046000000

0460660001	DEK 5 FSZ 1-10	D.17
0460660011	DEK 5 FSZ 11-20	D.17
0460660091	DEK 5 FSZ 91-100	D.17

047000000

0473360000	DEK 5 NEUTRAL	D.17
0473390000	DEK 5 NEUTRAL FARBIG	D.17
0473391686	DEK 5 RT NEUTRAL	D.17
0473391687	DEK 5 GE NEUTRAL	D.17
0473391688	DEK 5 GN NEUTRAL	D.17
0473391689	DEK 5 VI NEUTRAL	D.17
0473391690	DEK 5 OR NEUTRAL	D.17
0473391691	DEK 5 GR NEUTRAL	D.17
0473391692	DEK 5 BR NEUTRAL	D.17
0473391693	DEK 5 BL NEUTRAL	D.17
0473391694	DEK 5 SW NEUTRAL	D.17
0473460001	DEK 5 FW 1-50	D.17
0473460051	DEK 5 FW 51-100	D.17

Order No.	Type	Page
-----------	------	------

0473460951	DEK 5 FW 951-999	D.17
0473560001	DEK 5 FS 1-50	D.17
0473560051	DEK 5 FS 51-100	D.17
0473560951	DEK 5 FS 951-999	D.17

048000000

0485200000	ADP 1/HP1 1M	I.44
------------	--------------	------

049000000

0490760000	DEK 5 SONDERDRUCK	D.17
0490790000	DEK 5 SONDERDRUCK FARB.	D.17

051000000

0514510000	TS 35X7.5/LL 1M/ST/ZN	I.35
------------	-----------------------	------

052000000

0522361075	DEK 5 GW L1	D.17
0522361076	DEK 5 GW L2	D.17
0522361077	DEK 5 GW L3	D.17
0522660001	DEK 5 GW 1	D.17
0522660002	DEK 5 GW 2	D.17
0522660200	DEK 5 GW 200	D.17
0522761021	DEK 5 GW A	D.17
0522761022	DEK 5 GW B	D.17
0522761023	DEK 5 GW C	D.17
0522761024	DEK 5 GW D	D.17
0522761025	DEK 5 GW E	D.17
0522761026	DEK 5 GW F	D.17
0522761027	DEK 5 GW G	D.17
0522761028	DEK 5 GW H	D.17
0522761029	DEK 5 GW I	D.17
0522761030	DEK 5 GW J	D.17
0522761031	DEK 5 GW K	D.17
0522761032	DEK 5 GW L	D.17
0522761033	DEK 5 GW M	D.17
0522761034	DEK 5 GW N	D.17
0522761035	DEK 5 GW O	D.17
0522761036	DEK 5 GW P	D.17
0522761037	DEK 5 GW Q	D.17
0522761038	DEK 5 GW R	D.17
0522761039	DEK 5 GW S	D.17
0522761040	DEK 5 GW T	D.17
0522761041	DEK 5 GW U	D.17
0522761042	DEK 5 GW V	D.17
0522761043	DEK 5 GW W	D.17
0522761044	DEK 5 GW X	D.17
0522761045	DEK 5 GW Y	D.17
0522761046	DEK 5 GW Z	D.17
0523060001	DEK 5 FWZ 1-10	D.17
0523060011	DEK 5 FWZ 11-20	D.17
0523060091	DEK 5 FWZ 91-100	D.17

056000000

0569860000	TOP1.5GS2/180 5.2STI OR	B.47
------------	-------------------------	------

057000000

0570160000	TOP1.5GS3/180 5.2STI OR	B.47
0570360000	TOP1.5GS4/180 5.2STI OR	B.47
0570560000	TOP1.5GS10/180 5.2STI OR	B.47
0570760000	TOP1.5GS16/180 5.2STI OR	B.47
0570960000	TOP1.5GS8/180 7.2STI OR	B.49
0571160000	TOP1.5GS10/180 7.2STI OR	B.49
0576261198	DEK 5 GW +	D.17
0576261199	DEK 5 GW -	D.17
0576261202	DEK 5 GW ERDE	D.17
0576261203	DEK 5 GW ERDE LKR.	D.17
0576261215	DEK 5 GW W-STROM	D.17

059000000

0593860000	TOP1.5GS6/90 5.2STI OR	B.46
0593960000	TOP1.5GS7/90 5.2STI OR	B.46
0594060000	TOP1.5GS8/90 5.2STI OR	B.46
0594160000	TOP1.5GS9/90 5.2STI OR	B.46
0594260000	TOP1.5GS11/90 5.2STI OR	B.46
0594360000	TOP1.5GS12/90 5.2STI OR	B.46
0594460000	TOP1.5GS13/90 5.2STI OR	B.46
0594560000	TOP1.5GS14/90 5.2STI OR	B.46
0594660000	TOP1.5GS15/90 5.2STI OR	B.46
0594760000	TOP1.5GS17/90 5.2STI OR	B.46
0594860000	TOP1.5GS19/90 5.2STI OR	B.46
0595060000	TOP1.5GS20/90 5.2STI OR	B.46
0595160000	TOP1.5GS21/90 5.2STI OR	B.46
0595260000	TOP1.5GS22/90 5.2STI OR	B.46
0595360000	TOP1.5GS23/90 5.2STI OR	B.46
0595460000	TOP1.5GS24/90 5.2STI OR	B.46
0597360000	TOP1.5GS5/180 5.2STI OR	B.47
0597460000	TOP1.5GS6/180 5.2STI OR	B.47
0597660000	TOP1.5GS8/180 5.2STI OR	B.47
0597860000	TOP1.5GS12/180 5.2STI OR	B.47
0598160000	TOP1.5GS14/180 5.2STI OR	B.47
0598360000	TOP1.5GS17/180 5.2STI OR	B.47
0598460000	TOP1.5GS18/180 5.2STI OR	B.47

Order No.	Type	Page
-----------	------	------

0598560000	TOP1.5GS19/180 5.2STI OR	B.47
0598660000	TOP1.5GS20/180 5.2STI OR	B.47
0598760000	TOP1.5GS21/180 5.2STI OR	B.47
0598860000	TOP1.5GS22/180 5.2STI OR	B.47
0598960000	TOP1.5GS23/180 5.2STI OR	B.47
0599060000	TOP1.5GS24/180 5.2STI OR	B.47

064000000

0641960000	TOP1.5GS2/90 5.2STI OR	B.46
0642060000	TOP1.5GS3/90 5.2STI OR	B.46
0642160000	TOP1.5GS4/90 5.2STI OR	B.46
0642260000	TOP1.5GS10/90 5.2STI OR	B.46
0642360000	TOP1.5GS16/90 5.2STI OR	B.46
0642460000	TOP1.5GS8/90 7.2STI OR	B.48
0642560000	TOP1.5GS10/90 7.2STI OR	B.48
0646210000	MOFU 35/LD/1 SW	J.2

100000000

1000030001	BLF 5.08HC/02/90 SN BK BX	C.238
1000040001	BLF 5.08HC/03/90 SN BK BX	C.238
1000050001	BLF 5.08HC/04/90 SN BK BX	C.238
1000060001	BLF 5.08HC/05/90 SN BK BX	C.238
1000070001	BLF 5.08HC/06/90 SN BK BX	C.238
1000080001	BLF 5.08HC/07/90 SN BK BX	C.238
1000090001	BLF 5.08HC/08/90 SN BK BX	C.238
1000100001	BLF 5.08HC/09/90 SN BK BX	C.238
1000110001	BLF 5.08HC/10/90 SN BK BX	C.238
1000120001	BLF 5.08HC/11/90 SN BK BX	C.238
1000130001	BLF 5.08HC/12/90 SN BK BX	C.238
1000140001	BLF 5.08HC/13/90 SN BK BX	C.238
1000150001	BLF 5.08HC/14/90 SN BK BX	C.238
1000160001	BLF 5.08HC/15/90 SN BK BX	C.238
1000170001	BLF 5.08HC/16/90 SN BK BX	C.238
1000180001	BLF 5.08HC/17/90 SN BK BX	C.238
1000190001	BLF 5.08HC/18/90 SN BK BX	C.238
1000200001	BLF 5.08HC/19/90 SN BK BX	C.238
1000210001	BLF 5.08HC/20/90 SN BK BX	C.238
1000220001	BLF 5.08HC/02/90F SN BK BX	C.239
1000230001	BLF 5.08HC/03/90F SN BK BX	C.239
1000240001	BLF 5.08HC/04/90F SN BK BX	C.239
1000250001	BLF 5.08HC/05/90F SN BK BX	C.239
1000260001	BLF 5.08HC/06/90F SN BK BX	C.239
1000270001	BLF 5.08HC/07/90F SN BK BX	C.239
1000280001	BLF 5.08HC/08/90F SN BK BX	C.239
1000290001	BLF 5.08HC/09/90F SN BK BX	C.239
1000300001	BLF 5.08HC/10/90F SN BK BX	C.239
1000310001	BLF 5.08HC/11/90F SN BK BX	C.239
1000320001	BLF 5.08HC/12/90F SN BK BX	C.239
1000330001	BLF 5.08HC/13/90F SN BK BX	C.239
1000340001	BLF 5.08HC/14/90F SN BK BX	C.239
1000350001	BLF 5.08HC/15/90F SN BK BX	C.239
1000360001	BLF 5.08HC/16/90F SN BK BX	C.239
1000370001	BLF 5.08HC/17/90F SN BK BX	C.239
1000380001	BLF 5.08HC/18/90F SN BK BX	C.239
1000390001	BLF 5.08HC/19/90F SN BK BX	C.239
1000400001	BLF 5.08HC/20/90F SN BK BX	C.239
1000410001	BLF 5.08HC/02/90LR SN BK BX	C.239
1000420001	BLF 5.08HC/03/90LR SN BK BX	C.239
1000430001	BLF 5.08HC/04/90LR SN BK BX	C.239
100044000		

Table with columns: Order No., Type, Page. Contains order items 1014520000 to 1017890000.

Table with columns: Order No., Type, Page. Contains order items 1017910000 to 1018050000.

102000000

Table with columns: Order No., Type, Page. Contains order items 1020640000 to 1029990000.

103000000

Table with columns: Order No., Type, Page. Contains order items 1030010000 to 1030790000.

Table with columns: Order No., Type, Page. Contains order items 1030810000 to 1032530000.

Order No.	Type	Page
1060830000	SVF 7.62HP/02/180G SN BK BX	F.50
1060840000	SVF 7.62HP/03/180G SN BK BX	F.50
1060850000	SVF 7.62HP/04/180G SN BK BX	F.50
1060870000	SVF 7.62HP/05/180G SN BK BX	F.50
1060880000	SVF 7.62HP/06/180G SN BK BX	F.50
1060900000	SVF 7.62HP/02/180F SN BK BX	F.51
1060910000	SVF 7.62HP/03/180F SN BK BX	F.51
1060920000	SVF 7.62HP/04/180F SN BK BX	F.51
1060930000	SVF 7.62HP/05/180F SN BK BX	F.51
1060950000	SVF 7.62HP/02/180SF SN BK BX	F.51
1060970000	SVF 7.62HP/03/180SF SN BK BX	F.51
1060980000	SVF 7.62HP/04/180SF SN BK BX	F.51
1061000000	SVF 7.62HP/05/180SF SN BK BX	F.51
1061020000	SVF 7.62HP/02/180MF SN BK BX	F.54
1061030000	SVF 7.62HP/03/180MF2 SN BK BX	F.54
1061040000	SVF 7.62HP/03/180MF3 SN BK BX	F.55
1061050000	SVF 7.62HP/04/180MF SN BK BX	F.55
1061070000	SVF 7.62HP/05/180MF3 SN BK BX	F.55
1061080000	SVF 7.62HP/05/180MF4 SN BK BX	F.55
1061100000	SVF 7.62HP/02/180MSF SN BK BX	F.56
1061120000	SVF 7.62HP/03/180MSF2 SN BK BX	F.56
1061130000	SVF 7.62HP/03/180MSF3 SN BK BX	F.57
1061140000	SVF 7.62HP/04/180MSF SN BK BX	F.57
1061150000	SVF 7.62HP/05/180MSF3 SN BK BX	F.57
1061170000	SVF 7.62HP/05/180MSF4 SN BK BX	F.57
1063140000	SHL-SMT 5.00/03GR 1.5BX	L.21
1063150000	SHL-SMT 5.00/04GR 1.5BX	L.23
1063170000	SHL-SMT 5.00/03GR 1.5RL	L.21
1063180000	SHL-SMT 5.00/04GR 1.5RL	L.23
1063210000	SHL-SMT 5.00/03GL 1.5BX	L.21
1063220000	SHL-SMT 5.00/04GL 1.5BX	L.23
1063240000	SHL-SMT 5.00/03GL 1.5RL	L.21
1063250000	SHL-SMT 5.00/04GL 1.5RL	L.23
1063260000	BHZ 5.00/02/90LH BK/OR	L.19
1063270000	BHZ 5.00/03/90LH BK/OR	L.21
1063280000	BHZ 5.00/04/90LH BK/OR	L.23
1065080000	BLDF 5.08/05/180F SN DR BX	C.247
1065090000	BLDF 5.08/06/180F SN DR BX	C.247
1065110000	BLDF 5.08/07/180F SN DR BX	C.247
1065120000	BLDF 5.08/08/180F SN DR BX	C.247
1065130000	BLDF 5.08/02/180LR SN DR BX	C.247
1065140000	BLDF 5.08/03/180LR SN DR BX	C.247
1065150000	BLDF 5.08/04/180LR SN DR BX	C.247
1065160000	BLDF 5.08/05/180LR SN DR BX	C.247
1065170000	BLDF 5.08/06/180LR SN DR BX	C.247
1065180000	BLDF 5.08/07/180LR SN DR BX	C.247
1065190000	BLDF 5.08/08/180LR SN DR BX	C.247
1068510000	BLZP 5.08/16/90LR SN BK BX	C.221
1069330000	BHZ 5.00/02/90LH BK/BK	L.19
1069340000	BHZ 5.00/03/90LH BK/BK	L.21
1069350000	BHZ 5.00/04/90LH BK/BK	L.23
1069360000	BHZ 5.00/02/90LH BK/BL	L.19
1069370000	BHZ 5.00/03/90LH BK/BL	L.21
1069380000	BHZ 5.00/04/90LH BK/BL	L.23
1069550000	SHL-SMT 5.00/02GR 1.5BX	L.19
1069560000	SHL-SMT 5.00/03GR 4.2BX	L.21
1069570000	SHL-SMT 5.00/04GR 4.2BX	L.23
1069580000	SHL-SMT 5.00/02GR 4.2RL	L.19
1069590000	SHL-SMT 5.00/02GL 4.2RL	L.21
1069610000	SHL-SMT 5.00/04GR 4.2RL	L.23
1069620000	SHL-SMT 5.00/02GL 1.5BX	L.19
1069630000	SHL-SMT 5.00/03GL 4.2BX	L.21
1069640000	SHL-SMT 5.00/04GL 4.2BX	L.23
1069650000	SHL-SMT 5.00/02GL 4.2RL	L.19
1069660000	SHL-SMT 5.00/03GL 4.2RL	L.21
1069670000	SHL-SMT 5.00/04GL 4.2RL	L.23
1069680000	SHL-SMT 5.00/02GR 3.2BX	L.19
1069690000	SHL-SMT 5.00/03GR 5.9BX	L.21
1069710000	SHL-SMT 5.00/04GR 5.9BX	L.23
1069720000	SHL-SMT 5.00/02GR 5.9RL	L.19
1069730000	SHL-SMT 5.00/03GR 5.9RL	L.21
1069740000	SHL-SMT 5.00/04GR 5.9RL	L.23
1069750000	SHL-SMT 5.00/02GL 3.2BX	L.19
1069760000	SHL-SMT 5.00/03GL 5.9BX	L.21
1069770000	SHL-SMT 5.00/04GL 5.9BX	L.23
1069780000	SHL-SMT 5.00/02GL 5.9RL	L.19
1069790000	SHL-SMT 5.00/03GL 5.9RL	L.21
1069810000	SHL-SMT 5.00/04GL 5.9RL	L.23

1070000000

1071710000	SCZ 3.81/05/180GZE SN BK BX	C.104
1071720000	SCZ 3.81/06/180GZE SN BK BX	C.104
1071730000	SCZ 3.81/07/180GZE SN BK BX	C.104
1071740000	SCZ 3.81/08/180GZE SN BK BX	C.104
1071750000	SCZ 3.81/09/180GZE SN BK BX	C.104
1071760000	SCZ 3.81/10/180GZE SN BK BX	C.104
1071770000	SCZ 3.81/11/180GZE SN BK BX	C.104
1071780000	SCZ 3.81/12/180GZE SN BK BX	C.104
1071790000	SCZ 3.81/05/180FZE SN BK BX	C.105
1071810000	SCZ 3.81/06/180FZE SN BK BX	C.105
1071820000	SCZ 3.81/07/180FZE SN BK BX	C.105
1071830000	SCZ 3.81/08/180FZE SN BK BX	C.105
1071840000	SCZ 3.81/09/180FZE SN BK BX	C.105
1071850000	SCZ 3.81/10/180FZE SN BK BX	C.105
1071860000	SCZ 3.81/11/180FZE SN BK BX	C.105
1071870000	SCZ 3.81/12/180FZE SN BK BX	C.105
1071950000	BCZ 3.81/05/180ZE SN BK BX	C.108
1071960000	BCZ 3.81/06/180ZE SN BK BX	C.108

Order No.	Type	Page
1071970000	BCZ 3.81/07/180ZE SN BK BX	C.108
1071980000	BCZ 3.81/09/180ZE SN BK BX	C.108
1072010000	BCZ 3.81/10/180ZE SN BK BX	C.108
1072020000	BCZ 3.81/11/180ZE SN BK BX	C.108
1072030000	BCZ 3.81/12/180ZE SN BK BX	C.108
1072040000	BCZ 3.81/13/180ZE SN BK BX	C.108
1072050000	BCZ 3.81/14/180ZE SN BK BX	C.108
1072060000	BCZ 3.81/15/180ZE SN BK BX	C.108
1072070000	BCZ 3.81/16/180ZE SN BK BX	C.108
1072080000	BCZ 3.81/17/180ZE SN BK BX	C.108
1072090000	BCZ 3.81/18/180ZE SN BK BX	C.108
1072110000	BCZ 3.81/19/180ZE SN BK BX	C.108
1072120000	BCZ 3.81/20/180ZE SN BK BX	C.108
1072130000	BCZ 3.81/05/180FZE SN BK BX	C.109
1072140000	BCZ 3.81/06/180FZE SN BK BX	C.109
1072150000	BCZ 3.81/07/180FZE SN BK BX	C.109
1072160000	BCZ 3.81/09/180FZE SN BK BX	C.109
1072170000	BCZ 3.81/10/180FZE SN BK BX	C.109
1072180000	BCZ 3.81/11/180FZE SN BK BX	C.109
1072190000	BCZ 3.81/12/180FZE SN BK BX	C.109
1072200000	BCZ 3.81/13/180FZE SN BK BX	C.109
1072230000	BCZ 3.81/14/180FZE SN BK BX	C.109
1072240000	BCZ 3.81/15/180FZE SN BK BX	C.109
1072250000	BCZ 3.81/16/180FZE SN BK BX	C.109
1072260000	BCZ 3.81/17/180FZE SN BK BX	C.109
1072270000	BCZ 3.81/18/180FZE SN BK BX	C.109
1072280000	BCZ 3.81/19/180LRZE SN BK BX	C.109
1072290000	BCZ 3.81/20/180LRZE SN BK BX	C.109
1072310000	BCZ 3.81/05/180LRZE SN BK BX	C.109
1072320000	BCZ 3.81/06/180LRZE SN BK BX	C.109
1072330000	BCZ 3.81/07/180LRZE SN BK BX	C.109
1072340000	BCZ 3.81/09/180LRZE SN BK BX	C.109
1072350000	BCZ 3.81/10/180LRZE SN BK BX	C.109
1072360000	BCZ 3.81/11/180LRZE SN BK BX	C.109
1072370000	BCZ 3.81/12/180LRZE SN BK BX	C.109
1072380000	BCZ 3.81/13/180LRZE SN BK BX	C.109
1072390000	BCZ 3.81/14/180LRZE SN BK BX	C.109
1072450000	BCZ 3.81/15/180LRZE SN BK BX	C.109
1072460000	BCZ 3.81/16/180LRZE SN BK BX	C.109
1072470000	BCZ 3.81/17/180LRZE SN BK BX	C.109
1072480000	BCZ 3.81/18/180LRZE SN BK BX	C.109
1072490000	BCZ 3.81/19/180LRZE SN BK BX	C.109
1072510000	BCZ 3.81/20/180LRZE SN BK BX	C.109
1073410000	CH20M6 C TP	L.17
1073420000	CH20M22 C TP	L.23

1080000000

1080320000	BVF 7.62HP/02/180 BCF/06R SN BK BX	F.120
1080440000	BVF 7.62HP/04/180 BCF/06R SN BK BX	F.120
1080490000	BVF 7.62HP/03/180 BCF/04R SN BK BX	F.120
1080510000	BVF 7.62HP/04/180 BCF/04R SN BK BX	F.120
1080550000	BVF 7.62HP/02/180 BCF/04R SN BK BX	F.120
1080570000	BVF 7.62HP/03/180 BCF/06R SN BK BX	F.120
1080630000	CH20M22 S PSCSC BK	L.22
1081030000	BVF 7.62HP/02/180MF BCF/06R SN BK BX	F.121
1081150000	BVF 7.62HP/04/180MF4 BCF/04R SN BK BX	F.121
1081610000	BVF 7.62HP/02/180MF BCF/04R SN BK BX	F.121
1081630000	BVF 7.62HP/03/180MF3 BCF/04R SN BK BX	F.121
1081660000	BVF 7.62HP/04/180MF4 BCF/04R SN BK BX	F.122
1081720000	BVF 7.62HP/03/180MF3 BCF/06R SN BK BX	F.121
1081730000	BVF 7.62HP/03/180MF3 BCF/06R SN BK BX	F.122
1081750000	BVF 7.62HP/04/180MF4 BCF/06R SN BK BX	F.122
1081760000	BVF 7.62HP/05/180MF4 BCF/06R SN BK BX	F.121
1081930000	BVF 7.62HP/02/180MSF BCF/06R SN BK BX	F.122
1082020000	BVF 7.62HP/04/180MF4 BCF/06R SN BK BX	F.121
1082080000	BVF 7.62HP/02/180MSF BCF/06R SN BK BX	F.122
1082110000	BVF 7.62HP/03/180MSF3 BCF/04R SN BK BX	F.122
1082140000	BVF 7.62HP/05/180MF4 BCF/04R SN BK BX	F.121
1082490000	ESG 6.6/11 BHZ 5.00/02	L.19
1082520000	ESG 6.6/15 BHZ 5.00/03	L.21
1082540000	ESG 6.6/20 BHZ 5.00/04	L.23
1087020000	BLZP 5.08/02/90LR SN BK BX	C.221
1087030000	BLZP 5.08/03/90LR SN BK BX	C.221
1087040000	BLZP 5.08/04/90LR SN BK BX	C.221
1087050000	BLZP 5.08/05/90LR SN BK BX	C.221
1087060000	BLZP 5.08/06/90LR SN BK BX	C.221
1087070000	BLZP 5.08/07/90LR SN BK BX	C.221
1087080000	BLZP 5.08/08/90LR SN BK BX	C.221
1087100000	BLZP 5.08/09/90LR SN BK BX	C.221
1087110000	BLZP 5.08/10/90LR SN BK BX	C.221
1087120000	BLZP 5.08/11/90LR SN BK BX	C.221
1087130000	BLZP 5.08/12/90LR SN BK BX	C.221
1087140000	BLZP 5.08/13/90LR SN BK BX	C.221
1087150000	BLZP 5.08/14/90LR SN BK BX	C.221
1087160000	BLZP 5.08/15/90LR SN BK BX	C.221
1087170000	BLZP 5.08/17/90LR SN BK BX	C.221
1087180000	BLZP 5.08/18/90LR SN BK BX	C.221
1087190000	BLZP 5.08/19/90LR SN BK BX	C.221
1087200000	BLZP 5.08/20/90LR SN BK BX	C.221
1087210000	BLZP 5.08/21/90LR SN BK BX	C.221
1087220000	BLZP 5.08/22/90LR SN BK BX	C.221
1087230000	BLZP 5.08/23/90LR SN BK BX	C.221
1087240000	BLZP 5.08/24/90LR SN BK BX	C.221
1087250000	BLZP 5.08/02/90LR SN DR BX	C.221
1087260000	BLZP 5.08/03/90LR SN DR BX	C.221
1087270000	BLZP 5.08/04/90LR SN DR BX	C.221
1087280000	BLZP 5.08/05/90LR SN DR BX	C.221
1087290000	BLZP 5.08/06/90LR SN DR BX	C.221

Order No.	Type	Page
1087300000	BLZP 5.08/07/90LR SN DR BX	C.221
1087310000	BLZP 5.08/08/90LR SN DR BX	C.221
1087320000	BLZP 5.08/09/90LR SN DR BX	C.221
1087330000	BLZP 5.08/10/90LR SN DR BX	C.221
1087340000	BLZP 5.08/11/90LR SN DR BX	C.221
1087350000	BLZP 5.08/12/90LR SN DR BX	C.221
1087360000	BLZP 5.08/13/90LR SN DR BX	C.221
1087370000	BLZP 5.08/14/90LR SN DR BX	C.221
1087380000	BLZP 5.08/15/90LR SN DR BX	C.221
1087390000	BLZP 5.08/16/90LR SN DR BX	C.221
1087400000	BLZP 5.08/17/90LR SN DR BX	C.221
1087410000	BLZP 5.08/18/90LR SN DR BX	C.221
1087420000	BLZP 5.08/19/90LR SN DR BX	C.221
1087430000	BLZP 5.08/20/90LR SN DR BX	C.221
1087440000	BLZP 5.08/21/90LR SN DR BX	C.221
1087450000	BLZP 5.08/22/90LR SN DR BX	C.221
1087460000	BLZP 5.08/23/90LR SN DR BX	C.221
1087470000	BLZP 5.08/24/90LR SN DR BX	C.221
1089260000	SV 7.62HP/02/270MF SC/04R SN BK BX	F.119
1089280000	SV 7.62HP/02/270MF SC/06R SN BK BX	F.119
1089340000	SV 7.62HP/02/270MSF SC/04R SN BK BX	F.119
1089370000	SV 7.62HP/02/90MF SC/04R SN BK BX	F.117
1089380000	SV 7.62HP/02/270MSF SC/06R SN BK BX	F.119
1089410000	SV 7.62HP/02/90MF SC/06R SN BK BX	F.117
1089440000	SV 7.62HP/03/270MF3 SC/04R SN BK BX	F.119
1089490000	SV 7.62HP/03/270MF3 SC/06R SN BK BX	F.119
1089510000	SV 7.62HP/02/90MSF SC/04R SN BK BX	F.117
1089570000	SV 7.62HP/02/90MSF SC/06R SN BK BX	F.117
1089610000	SV 7.62HP/03/270MSF3 SC/04R SN BK BX	F.119
1089660000	SV 7.62HP/03/90MF3 SC/04R SN BK BX	F.117
1089670000	SV 7.62HP/03/270MSF3 SC/06R SN BK BX	F.119
1089730000	SV 7.62HP/03/90MF3 SC/06R SN BK BX	F.117
1089820000	SV 7.62HP/02/270MF4 SC/04R SN BK BX	F.119
1089840000	SV 7.62HP/02/90G SC/04R SN BK BX	F.116
108989		

Order No.	Type	Page
1156250000	SV 7.62HP/03/90MSF2 SC/04R SN BK BX	F.117
1156270000	SV 7.62HP/03/90MSF2 SC/06R SN BK BX	F.117
1156280000	SV 7.62HP/04/270MF4 SC/08R SN BK BX	F.119
1156290000	SV 7.62HP/04/270MF4 SC/08R SN BK BX	F.119
1156300000	SV 7.62HP/05/270MF3 SC/04R SN BK BX	F.119
1156310000	SV 7.62HP/05/270MF3 SC/06R SN BK BX	F.119
1156320000	SV 7.62HP/05/270MF3 SC/08R SN BK BX	F.119
1156340000	SV 7.62HP/05/270MF4 SC/08R SN BK BX	F.119
1156370000	SV 7.62HP/05/270MSF3 SC/04R SN BK BX	F.119
1156390000	SV 7.62HP/05/270MSF3 SC/06R SN BK BX	F.119
1156410000	SV 7.62HP/05/270MSF3 SC/08R SN BK BX	F.119
1156430000	SV 7.62HP/05/270MSF4 SC/08R SN BK BX	F.119
1156440000	BVF 7.62HP/02/180 BCF/08R SN BK BX	F.120
1156450000	BVF 7.62HP/03/180 BCF/08R SN BK BX	F.120
1156470000	BVF 7.62HP/04/180 BCF/08R SN BK BX	F.120
1156480000	BVF 7.62HP/05/180 BCF/08R SN BK BX	F.120
1156490000	SV 7.62HP/05/270MF2 3.2SN BK BX SO	F.102
1156500000	SV 7.62HP/03/270MF2 3.2SN BK BX	F.102
1156510000	SV 7.62HP/03/270MF3 3.2SN BK BX	F.103
1156520000	SV 7.62HP/04/270MF2 3.2SN BK BX	F.102
1156530000	SV 7.62HP/04/270MF4 3.2SN BK BX	F.103
1156540000	SV 7.62HP/02/90MF2 3.2SN BK BX SO	F.100
1156550000	SV 7.62HP/03/90MF2 3.2SN BK BX	F.100
1156570000	SV 7.62HP/03/90MF3 3.2SN BK BX	F.101
1156580000	SV 7.62HP/04/90MF2 3.2SN BK BX	F.100
1156590000	SV 7.62HP/04/90MF4 3.2SN BK BX	F.101
1156600000	BUZ 10.16IT/02/180MF AG BK BX	F.110
1156610000	BUZ 10.16IT/03/180MF2 AG BK BX	F.110
1156620000	BUZ 10.16IT/03/180MF3 AG BK BX	F.111
1156630000	BUZ 10.16IT/04/180MF2 AG BK BX	F.110
1156640000	BUZ 10.16IT/04/180MF4 AG BK BX	F.111
1156650000	SU 10.16IT/02/90MF2 3.5AG BK BX SO	F.106
1156670000	SU 10.16IT/03/90MF2 3.5AG BK BX	F.106
1156680000	SU 10.16IT/03/90MF3 3.5AG BK BX	F.107
1156690000	SU 10.16IT/04/90MF2 3.5AG BK BX	F.106
1156700000	SU 10.16IT/04/90MF4 3.5AG BK BX	F.107
1156710000	BVZ 7.62HP/02/180MF SN BK BX	F.104
1156720000	BVZ 7.62HP/03/180MF2 SN BK BX	F.104
1156730000	BVZ 7.62HP/03/180MF3 SN BK BX	F.105
1156740000	BVZ 7.62HP/04/180MF2 SN BK BX	F.104
1156750000	BVZ 7.62HP/04/180MF4 SN BK BX	F.105
1156820000	SV 7.62HP/02/90MSF SC/08R SN BK BX	F.117
1156830000	SV 7.62HP/02/90MSF SC/08R SN BK BX	F.117
1156840000	SV 7.62HP/03/90MF2 SC/08R SN BK BX	F.117
1156850000	SV 7.62HP/03/90MF3 SC/08R SN BK BX	F.117
1156870000	SV 7.62HP/03/90MSF2 SC/08R SN BK BX	F.117
1156880000	SV 7.62HP/03/90MSF3 SC/08R SN BK BX	F.117
1156890000	SV 7.62HP/04/90MF4 SC/08R SN BK BX	F.117
1156900000	SV 7.62HP/04/90MSF4 SC/08R SN BK BX	F.117
1156910000	SV 7.62HP/05/90MF3 SC/04R SN BK BX	F.117
1156920000	SV 7.62HP/02/270G SC/08R SN BK BX	F.118
1156930000	SV 7.62HP/05/90MF3 SC/08R SN BK BX	F.117
1156940000	SV 7.62HP/03/270G SC/08R SN BK BX	F.118
1156950000	SV 7.62HP/05/90MF3 SC/08R SN BK BX	F.117
1156970000	SV 7.62HP/04/270G SC/08R SN BK BX	F.118
1156980000	SV 7.62HP/05/90MF4 SC/08R SN BK BX	F.117
1156990000	SV 7.62HP/05/270G SC/08R SN BK BX	F.118
1157000000	SV 7.62HP/05/90MSF3 SC/04R SN BK BX	F.117
1157010000	SV 7.62HP/05/90MSF3 SC/06R SN BK BX	F.117
1157020000	SV 7.62HP/05/90MSF3 SC/08R SN BK BX	F.117
1157030000	SV 7.62HP/05/90MSF4 SC/08R SN BK BX	F.117
1157040000	SV 7.62HP/02/90G SC/08R SN BK BX	F.116
1157050000	SV 7.62HP/03/90G SC/08R SN BK BX	F.116
1157080000	SV 7.62HP/05/90G SC/08R SN BK BX	F.116
1157090000	BVF 7.62HP/02/180MF BCF/08R SN BK BX	F.121
1157100000	BVF 7.62HP/02/180MSF BCF/08R SN BK BX	F.122
1157110000	BVF 7.62HP/03/180MF2 BCF/04R SN BK BX	F.121
1157120000	BVF 7.62HP/03/180MF2 BCF/06R SN BK BX	F.121
1157130000	BVF 7.62HP/03/180MF2 BCF/08R SN BK BX	F.121
1157170000	BVF 7.62HP/03/180MF3 BCF/08R SN BK BX	F.121
1157190000	BVF 7.62HP/03/180MSF3 BCF/08R SN BK BX	F.122
1157200000	BVF 7.62HP/04/180MF4 BCF/08R SN BK BX	F.121
1157210000	BVF 7.62HP/04/180MSF4 BCF/08R SN BK BX	F.122
1157220000	BVF 7.62HP/05/180MF3 BCF/04R SN BK BX	F.121
1157230000	BVF 7.62HP/05/180MF3 BCF/06R SN BK BX	F.121
1157240000	BVF 7.62HP/05/180MF3 BCF/08R SN BK BX	F.121
1157250000	BVF 7.62HP/05/180MF4 BCF/08R SN BK BX	F.121
1157270000	BVF 7.62HP/05/180MSF3 BCF/04R SN BK BX	F.122
1157280000	BVF 7.62HP/05/180MSF3 BCF/06R SN BK BX	F.122
1157290000	BVF 7.62HP/05/180MSF3 BCF/08R SN BK BX	F.122
1157300000	BVF 7.62HP/05/180MSF4 BCF/08R SN BK BX	F.122
1157310000	SU 10.16IT/02/270MF2 3.5AG BK BX SO	F.108
1157320000	SU 10.16IT/03/270MF2 3.5AG BK BX	F.108
1157330000	SU 10.16IT/03/270MF3 3.5AG BK BX	F.109
1157340000	SU 10.16IT/04/270MF2 3.5AG BK BX	F.108
1157350000	SU 10.16IT/04/270MF4 3.5AG BK BX	F.109
1157380000	SV 7.62HP/04/90G SC/08R SN BK BX	F.116
1157440000	BVF 7.62HP/03/180MSF2 BCF/04R SN BK BX	F.122
1157450000	BVF 7.62HP/03/180MSF2 BCF/06R SN BK BX	F.122
1157470000	BVF 7.62HP/03/180MSF2 BCF/08R SN BK BX	F.122

1160000000

1164630000	CH20M6 BP 4P4P BUS BK	I.16
1164640000	CH20M6 BC 4P4P BUS BK	I.16
1164650000	CH20M6 BP 4P4P FE BK	I.16
1164900000	CH20M45 FC BK	I.25
1164960000	BLZ 7.62HP/06/180LR SN BK BX	F.17
1164970000	BLZ 7.62HP/07/180LR SN BK BX	F.17

Order No.	Type	Page
1164980000	BLZ 7.62HP/08/180LR SN BK BX	F.17
1164990000	BLZ 7.62HP/09/180LR SN BK BX	F.17
1165000000	BLZ 7.62HP/10/180LR SN BK BX	F.17
1165010000	BLZ 7.62HP/11/180LR SN BK BX	F.17
1165020000	BLZ 7.62HP/12/180LR SN BK BX	F.17
1166180000	CH20M45 S P2SC/P2SC BK	I.24
1168970000	MIA 30 BK	J.2

1170000000

1173490000	BLZ 7.62IT/02/180MF2 SN BK BX	F.98
1173500000	BLZ 7.62IT/03/180MF2 SN BK BX	F.98
1173510000	BLZ 7.62IT/03/180MF3 SN BK BX	F.99
1173520000	BLZ 7.62IT/04/180MF2 SN BK BX	F.98
1173530000	BLZ 7.62IT/04/180MF4 SN BK BX	F.99
1173610000	SL 7.62IT/02/90MF2 3.2SN BK BX SO	F.96
1173640000	SL 7.62IT/03/90MF2 3.2SN BK BX	F.96
1173690000	SL 7.62IT/03/90MF3 3.2SN BK BX	F.97
1173730000	SL 7.62IT/04/90MF2 3.2SN BK BX	F.96
1173770000	SL 7.62IT/04/90MF4 3.2SN BK BX	F.97
1174280000	CH20M12 S PPP BK	I.18
1174720000	LX 15.00/03/90 4.5SN BK BX	E.10
1176980000	CH20M12 B BUS BK/OR	I.18
1176990000	CH20M12 B FE BK/OR	I.18
1177000000	CH20M22 B BUS BK/OR	I.22
1177010000	CH20M22 B FE BK/OR	I.22
1177020000	CH20M45 B BUS BK/OR	I.24
1177030000	CH20M45 B FE BK/OR	I.24

1180000000

1185060000	AP 100	I.48
1185160000	AP 100 D	I.48
1185260000	AP 110	I.48
1185360000	AP 110 D	I.48
1185460000	AP 111	I.48
1185560000	AP 111 D	I.48

1190000000

1190600000	SLH-THRS 08/16/180F 3.2SN BK BX	C.188
1192980000	LUP 10.16/02/90V 3.2SN BK BX	E.8
1192990000	LUP 10.16/03/90V 3.2SN BK BX	E.8
1193000000	LUP 10.16/04/90V 3.2SN BK BX	E.8
1193010000	LUP 10.16/05/90V 3.2SN BK BX	E.8
1193020000	LUP 10.16/06/90V 3.2SN BK BX	E.8
1193030000	LUP 10.16/07/90V 3.2SN BK BX	E.8
1193040000	LUP 10.16/08/90V 3.2SN BK BX	E.8
1193050000	LUP 10.16/09/90V 3.2SN BK BX	E.8
1193160000	CH20M BUS-AP LT 3S 35X7.5 & 15	I.35
1193170000	CH20M BUS-AP RE TS 35X7.5 & 15	I.35

1200000000

1203310000	SK Demo CH20M6	I.16
1209350000	CH20M22 FC BK	I.23

1220000000

1221310000	CH20M AD SHL 5.00/04 BK	I.23
1226220000	LU 10.16/04/90 4.5SN BK BX	E.6
1226230000	LU 10.16/05/90 4.5SN BK BX	E.6
1226240000	LU 10.16/06/90 4.5SN BK BX	E.6
1226250000	LU 10.16/07/90 4.5SN BK BX	E.6
1226260000	LU 10.16/08/90 4.5SN BK BX	E.6
1226270000	LU 10.16/09/90 4.5SN BK BX	E.6
1226280000	LU 10.16/10/90 4.5SN BK BX	E.6
1226290000	LUP 10.16/02/90 3.2SN BK BX	E.7
1226300000	LUP 10.16/03/90 3.2SN BK BX	E.7
1226310000	LUP 10.16/04/90 3.2SN BK BX	E.7
1226320000	LUP 10.16/05/90 3.2SN BK BX	E.7
1226330000	LUP 10.16/06/90 3.2SN BK BX	E.7
1226340000	LUP 10.16/07/90 3.2SN BK BX	E.7
1226350000	LUP 10.16/08/90 3.2SN BK BX	E.7
1226360000	LUP 10.16/09/90 3.2SN BK BX	E.7
1226370000	LUP 12.70/02/90 3.2SN BK BX	E.9
1226380000	LUP 12.70/03/90 3.2SN BK BX	E.9
1226390000	LUP 12.70/04/90 3.2SN BK BX	E.9
1226410000	LUP 12.70/05/90 3.2SN BK BX	E.9
1226420000	LUP 12.70/06/90 3.2SN BK BX	E.9
1226430000	LUP 12.70/07/90 3.2SN BK BX	E.9
1226440000	LUP 12.70/08/90 3.2SN BK BX	E.9
1226450000	LUP 12.70/09/90 3.2SN BK BX	E.9
1226460000	LX 15.00/01/90 4.5SN BK BX	E.10
1226470000	LX 15.00/02/90 4.5SN BK BX	E.10
1226480000	LX 15.00/04/90 4.5SN BK BX	E.10
1226490000	LX 15.00/05/90 4.5SN BK BX	E.10
1226500000	LX 15.00/06/90 4.5SN BK BX	E.10
1226510000	LX 15.00/07/90 4.5SN BK BX	E.10
1226520000	LXB 15.00/02/90 4.5SN BK BX	E.11
1226530000	LXB 15.00/03/90 4.5SN BK BX	E.11
1226540000	LXB 15.00/04/90 4.5SN BK BX	E.11
1226550000	LXB 15.00/05/90 4.5SN BK BX	E.11
1226560000	LXB 15.00/06/90 4.5SN BK BX	E.11
1226570000	LXB 15.00/07/90 4.5SN BK BX	E.11
1226580000	LXB 15.00/08/90 4.5SN BK BX	E.11
1226590000	LXL 15.00/01/90 4.5SN BK BX	E.11
1227340000	BLF 7.62HP/06/180 SN BK BX	F.18
1227350000	BLF 7.62HP/07/180 SN BK BX	F.18

Order No.	Type	Page
1227360000	BLF 7.62HP/08/180 SN BK BX	F.18
1227370000	BLF 7.62HP/09/180 SN BK BX	F.18
1227380000	BLF 7.62HP/10/180 SN BK BX	F.18
1227390000	BLF 7.62HP/11/180 SN BK BX	F.18
1227410000	BLF 7.62HP/12/180 SN BK BX	F.18
1227420000	BLF 7.62HP/06/180LR SN BK BX	F.19
1227430000	BLF 7.62HP/07/180LR SN BK BX	F.19
1227440000	BLF 7.62HP/08/180LR SN BK BX	F.19
1227450000	BLF 7.62HP/09/180LR SN BK BX	F.19
1227460000	BLF 7.62HP/10/180LR SN BK BX	F.19
1227490000	BLF 7.62HP/06/180F SN BK BX	F.19
1227510000	BLF 7.62HP/07/180F SN BK BX	F.19
1227520000	BLF 7.62HP/08/180F SN BK BX	F.19
1227530000	BLF 7.62HP/09/180F SN BK BX	F.19
1227540000	BLF 7.62HP/10/180F SN BK BX	F.19

1230000000

1231350000	BCF 3.81/05/180FZE SN BK BX	C.115
1231360000	BCF 3.81/06/180FZE SN BK BX	C.115
1231370000	BCF 3.81/07/180FZE SN BK BX	C.115
1231380000	BCF 3.81/08/180FZE SN BK BX	C.115
1231390000	BCF 3.81/09/180FZE SN BK BX	C.115
1231410000	BCF 3.81/10/180FZE SN BK BX	C.115
1231420000	BCF 3.81/11/180FZE SN BK BX	C.115
1231430000	BCF 3.81/12/180FZE SN BK BX	C.115
1231440000	BCF 3.81/13/180FZE SN BK BX	C.115
1231450000	BCF 3.81/14/180FZE SN BK BX	C.115
1231460000	BCF 3.81/15/180FZE SN BK BX	C.115
1231470000	BCF 3.81/16/180FZE SN BK BX	C.115
1231480000	BCF 3.81/17/180FZE SN BK BX	C.115
1231490000	BCF 3.81/18/180FZE SN BK BX	C.115
1231520000	BCF 3.81/05/180LRZE SN BK BX	C.115
1231530000	BCF 3.81/06/180LRZE SN BK BX	C.115
1231540000	BCF 3.81/07/180LRZE SN BK BX	C.115
1231550000	BCF 3.81/08/180LRZE SN BK BX	C.115

Order No.	Type	Page
1236000000	BCF 3.81/08/180FZE SN OR BX	C.115
1236010000	BCF 3.81/09/180FZE SN OR BX	C.115
1236020000	BCF 3.81/10/180FZE SN OR BX	C.115
1236030000	BCF 3.81/11/180FZE SN OR BX	C.115
1236040000	BCF 3.81/12/180FZE SN OR BX	C.115
1236050000	BCF 3.81/13/180FZE SN OR BX	C.115
1236070000	BCF 3.81/14/180FZE SN OR BX	C.115
1236080000	BCF 3.81/15/180FZE SN OR BX	C.115
1236090000	BCF 3.81/16/180FZE SN OR BX	C.115
1236100000	BCF 3.81/17/180FZE SN OR BX	C.115
1236110000	BCF 3.81/18/180FZE SN OR BX	C.115
1236120000	BCF 3.81/05/180LRZE SN OR BX	C.115
1236130000	BCF 3.81/06/180LRZE SN OR BX	C.115
1236140000	BCF 3.81/07/180LRZE SN OR BX	C.115
1236150000	BCF 3.81/08/180LRZE SN OR BX	C.115
1236160000	BCF 3.81/09/180LRZE SN OR BX	C.115
1236170000	BCF 3.81/10/180LRZE SN OR BX	C.115
1236180000	BCF 3.81/11/180LRZE SN OR BX	C.115
1236190000	BCF 3.81/12/180LRZE SN OR BX	C.115
1236200000	BCF 3.81/13/180LRZE SN OR BX	C.115
1236210000	BCF 3.81/14/180LRZE SN OR BX	C.115
1236220000	BCF 3.81/15/180LRZE SN OR BX	C.115
1236230000	BCF 3.81/16/180LRZE SN OR BX	C.115
1236240000	BCF 3.81/17/180LRZE SN OR BX	C.115
1236250000	BCF 3.81/18/180LRZE SN OR BX	C.115
1236270000	BCF 3.81/05/180ZE SN OR BX	C.108
1236280000	BCF 3.81/06/180ZE SN OR BX	C.108
1236290000	BCF 3.81/07/180ZE SN OR BX	C.108
1236300000	BCF 3.81/08/180ZE SN OR BX	C.108
1236320000	BCF 3.81/09/180ZE SN OR BX	C.108
1236330000	BCF 3.81/10/180ZE SN OR BX	C.108
1236340000	BCF 3.81/11/180ZE SN OR BX	C.108
1236370000	BCF 3.81/12/180ZE SN OR BX	C.108
1236380000	BCF 3.81/13/180ZE SN OR BX	C.108
1236390000	BCF 3.81/14/180ZE SN OR BX	C.108
1236400000	BCF 3.81/15/180ZE SN OR BX	C.108
1236410000	BCF 3.81/16/180ZE SN OR BX	C.108
1236420000	BCF 3.81/17/180ZE SN OR BX	C.108
1236430000	BCF 3.81/18/180ZE SN OR BX	C.108
1236440000	BCF 3.81/19/180ZE SN OR BX	C.108
1236470000	BCF 3.81/20/180ZE SN OR BX	C.108
1236530000	BCZ 3.81/05/180FZE SN OR BX	C.109
1236540000	BCZ 3.81/06/180FZE SN OR BX	C.109
1236570000	BCZ 3.81/07/180FZE SN OR BX	C.109
1236590000	BCZ 3.81/08/180FZE SN OR BX	C.109
1236600000	BCZ 3.81/09/180FZE SN OR BX	C.109
1236610000	BCZ 3.81/10/180FZE SN OR BX	C.109
1236620000	BCZ 3.81/11/180FZE SN OR BX	C.109
1236630000	BCZ 3.81/12/180FZE SN OR BX	C.109
1236640000	BCZ 3.81/13/180FZE SN OR BX	C.109
1236670000	BCZ 3.81/14/180FZE SN OR BX	C.109
1236680000	BCZ 3.81/15/180FZE SN OR BX	C.109
1236690000	BCZ 3.81/16/180FZE SN OR BX	C.109
1236700000	BCZ 3.81/17/180FZE SN OR BX	C.109
1236720000	BCZ 3.81/18/180FZE SN OR BX	C.109
1236730000	BCZ 3.81/19/180FZE SN OR BX	C.109
1236740000	BCZ 3.81/20/180FZE SN OR BX	C.109
1236790000	BCZ 3.81/05/180LRZE SN OR BX	C.109
1236800000	BCZ 3.81/06/180LRZE SN OR BX	C.109
1236810000	BCZ 3.81/07/180LRZE SN OR BX	C.109
1236820000	BCZ 3.81/08/180LRZE SN OR BX	C.109
1236830000	BCZ 3.81/09/180LRZE SN OR BX	C.109
1236840000	BCZ 3.81/10/180LRZE SN OR BX	C.109
1236850000	BCZ 3.81/11/180LRZE SN OR BX	C.109
1236870000	BCZ 3.81/12/180LRZE SN OR BX	C.109
1236880000	BCZ 3.81/13/180LRZE SN OR BX	C.109
1236890000	BCZ 3.81/14/180LRZE SN OR BX	C.109
1236900000	BCZ 3.81/15/180LRZE SN OR BX	C.109
1236910000	BCZ 3.81/16/180LRZE SN OR BX	C.109
1236920000	BCZ 3.81/17/180LRZE SN OR BX	C.109
1236930000	BCZ 3.81/18/180LRZE SN OR BX	C.109
1236940000	BCZ 3.81/19/180LRZE SN OR BX	C.109
1236970000	BCZ 3.81/20/180LRZE SN OR BX	C.109
1236990000	SCZ 3.81/04/180GZE SN BK BX	C.104
1237000000	SCZ 3.81/05/180GZE SN OR BX	C.104
1237010000	SCZ 3.81/06/180GZE SN OR BX	C.104
1237020000	SCZ 3.81/07/180GZE SN OR BX	C.104
1237030000	SCZ 3.81/08/180GZE SN OR BX	C.104
1237040000	SCZ 3.81/09/180GZE SN OR BX	C.104
1237070000	SCZ 3.81/10/180GZE SN OR BX	C.104
1237080000	SCZ 3.81/11/180GZE SN OR BX	C.104
1237090000	SCZ 3.81/12/180GZE SN OR BX	C.104
1237100000	SCZ 3.81/13/180GZE SN OR BX	C.104
1237110000	SCZ 3.81/04/180FZE SN BK BX	C.105
1237120000	SCZ 3.81/05/180FZE SN OR BX	C.105
1237130000	SCZ 3.81/06/180FZE SN OR BX	C.105
1237140000	SCZ 3.81/07/180FZE SN OR BX	C.105
1237170000	SCZ 3.81/08/180FZE SN OR BX	C.105
1237180000	SCZ 3.81/09/180FZE SN OR BX	C.105
1237190000	SCZ 3.81/10/180FZE SN OR BX	C.105
1237200000	SCZ 3.81/11/180FZE SN OR BX	C.105
1237210000	SCZ 3.81/12/180FZE SN OR BX	C.105
1237230000	SCZ 3.81/04/180LRZE SN BK BX	C.105
1237240000	SCZ 3.81/05/180LRZE SN BK BX	C.105
1237270000	SCZ 3.81/06/180LRZE SN BK BX	C.105
1237280000	SCZ 3.81/07/180LRZE SN BK BX	C.105
1237290000	SCZ 3.81/08/180LRZE SN BK BX	C.105
1237300000	SCZ 3.81/09/180LRZE SN BK BX	C.105

Order No.	Type	Page
1237310000	SCZ 3.81/10/180LRZE SN BK BX	C.105
1237320000	SCZ 3.81/11/180LRZE SN BK BX	C.105
1237330000	SCZ 3.81/12/180LRZE SN BK BX	C.105
1237340000	SCZ 3.81/04/180LRZE SN OR BX	C.105
1237350000	SCZ 3.81/05/180LRZE SN OR BX	C.105
1237370000	SCZ 3.81/06/180LRZE SN OR BX	C.105
1237380000	SCZ 3.81/07/180LRZE SN OR BX	C.105
1237390000	SCZ 3.81/08/180LRZE SN OR BX	C.105
1237400000	SCZ 3.81/09/180LRZE SN OR BX	C.105
1237410000	SCZ 3.81/10/180LRZE SN OR BX	C.105
1237420000	SCZ 3.81/11/180LRZE SN OR BX	C.105
1237430000	SCZ 3.81/12/180LRZE SN OR BX	C.105
1237440000	SCZ 3.81/04/180FZE SN BK BX	C.105
1237450000	SCZ 3.81/05/180FZE SN BK BX	C.105
1237470000	SCZ 3.81/06/180FZE SN BK BX	C.105
1237480000	SCZ 3.81/07/180FZE SN BK BX	C.105
1237490000	SCZ 3.81/08/180FZE SN BK BX	C.105
1237510000	SCZ 3.81/09/180FZE SN BK BX	C.105
1237520000	SCZ 3.81/10/180FZE SN BK BX	C.105
1237530000	SCZ 3.81/11/180FZE SN BK BX	C.105
1237540000	SCZ 3.81/12/180FZE SN BK BX	C.105
1237550000	SCZ 3.81/04/180FZE SN OR BX	C.105
1237560000	SCZ 3.81/05/180FZE SN OR BX	C.105
1237570000	SCZ 3.81/06/180FZE SN OR BX	C.105
1237580000	SCZ 3.81/07/180FZE SN OR BX	C.105
1237590000	SCZ 3.81/08/180FZE SN OR BX	C.105
1237610000	SCZ 3.81/09/180FZE SN OR BX	C.105
1237620000	SCZ 3.81/10/180FZE SN OR BX	C.105
1237630000	SCZ 3.81/11/180FZE SN OR BX	C.105
1237640000	SCZ 3.81/12/180FZE SN OR BX	C.105

1240000000

1247240000	CH20M67 B BUS BK/OR	L26
1247250000	CH20M67 B FE BK/OR	L26
1248150000	CH20M BUS-PROFIL TS 35X7.5/250	L35
1248160000	CH20M BUS-PROFIL TS 35X7.5/500	L35
1248170000	CH20M BUS-PROFIL TS 35X7.5/750	L35
1248180000	CH20M BUS-PROFIL TS 35X15/250	L35
1248190000	CH20M BUS-PROFIL TS 35X15/500	L35
1248210000	CH20M BUS-PROFIL TS 35X15/750	L35
1248220000	CH20M BUS 4.50/05 AU/250	L35
1248230000	CH20M BUS 4.50/05 AU/500	L35
1248240000	CH20M BUS 4.50/05 AU/750	L35
1248250000	CH20M BUS-ADP TS 35/250	L35
1248260000	CH20M BUS-ADP TS 35/500	L35
1248270000	CH20M BUS-ADP TS 35/750	L35

1250000000

1250360000	LSF-SMD 3.50/02/180 SN BK RL	B.58
1250370000	LSF-SMD 3.50/03/180 SN BK RL	B.58
1250380000	LSF-SMD 3.50/04/180 SN BK RL	B.58
1250390000	LSF-SMD 3.50/05/180 SN BK RL	B.58
1250410000	LSF-SMD 3.50/06/180 SN BK RL	B.58
1250420000	LSF-SMD 3.50/07/180 SN BK RL	B.58
1250430000	LSF-SMD 3.50/08/180 SN BK RL	B.58
1250440000	LSF-SMD 3.50/09/180 SN BK RL	B.58
1250450000	LSF-SMD 3.50/10/180 SN BK RL	B.58
1250460000	LSF-SMD 3.50/11/180 SN BK RL	B.58
1250470000	LSF-SMD 3.50/12/180 SN BK RL	B.58
1250570000	DP WGK 10 SW	G.9
1250580000	DP WGK 16 SW	G.11
1250590000	DP WGK 25 SW	G.12
1250610000	DP WGK 50 SW	G.13
1250620000	DP WGK 95 SW	G.14
1250630000	DP VWGK 6 SW	G.15
1250640000	VWGK 6 SW	G.15
1250650000	VWGK 4 SW	G.15
1250660000	WGK 95 F VPZ SW	G.14
1250670000	WGK 95 F VPZ SW	G.14
1250680000	WGK 95 SW	G.13
1250690000	WGK 95/2 SW	G.13
1250710000	WGK 50 VPZ SW	G.13
1250720000	WGK 50 VPZ SW	G.13
1250730000	WGK 50 SW	G.13
1250740000	WGK 50/2 SW	G.13
1250750000	WGK 25 VPZ SW	G.12
1250760000	WGK 25 VPZ SW	G.12
1250770000	WGKV 25 SW	G.12
1250780000	WGKV 25/2 SW	G.12
1250790000	WGK 25 SW	G.11
1250810000	WGK 25/2 SW	G.11
1250820000	WGK 16 VPZ SW	G.11
1250830000	WGK 16 VPZ SW	G.11
1250840000	WGKV 16 SW	G.11
1250850000	WGKV 16/2 SW	G.11
1250860000	WGK 16 SW	G.10
1250870000	WGK 16/2 SW	G.10
1250880000	WGK 10 SW	G.9
1250890000	WGK 10/2 SW	G.9
1250910000	WGKV 10 SW	G.9
1250920000	WGKV 10/2 SW	G.9
1250930000	WGK 4 SW	G.8
1250940000	WGK 4/2 SW	G.8
1250950000	WGKV 4 SW	G.8
1250960000	WGKV 4/2 SW	G.8
1251030000	DP VWGK 4 SW	G.15
1251330000	LL 5.00/13/90 3.2SN OR BX	B.38

Order No.	Type	Page
1251340000	LL 5.00/15/90 3.2SN OR BX	B.38
1251350000	LL 5.00/17/90 3.2SN OR BX	B.38
1251360000	LL 5.00/18/90 3.2SN OR BX	B.38
1251370000	LL 5.00/19/90 3.2SN OR BX	B.38
1251380000	LL 5.00/20/90 3.2SN OR BX	B.38
1251390000	LL 5.00/21/90 3.2SN OR BX	B.38
1251410000	LL 5.00/22/90 3.2SN OR BX	B.38
1251420000	LL 5.00/23/90 3.2SN OR BX	B.38
1254110000	CH20M AD SHL 5.00/03 BK	L21
1254120000	CH20M17 B BK/BK	L20
1254130000	CH20M17 B BK/OR	L20
1254140000	CH20M17 F BK	L21
1254150000	CH20M17 C BK	L21
1254160000	CH20M17 C TP	L21
1254170000	CH20M17 S PPP BK	L20
1254180000	CH20M17 B BUS BK/OR	L20
1254190000	CH20M17 B FE BK/OR	L20

1270000000

1277270000	B2CF 3.50/04/180 SN OR BX	C.12
1277280000	B2CF 3.50/06/180 SN OR BX	C.12
1277290000	B2CF 3.50/08/180 SN OR BX	C.12
1277310000	B2CF 3.50/10/180 SN OR BX	C.12
1277320000	B2CF 3.50/12/180 SN OR BX	C.12
1277330000	B2CF 3.50/14/180 SN OR BX	C.12
1277340000	B2CF 3.50/16/180 SN OR BX	C.12
1277350000	B2CF 3.50/18/180 SN OR BX	C.12
1277360000	B2CF 3.50/20/180 SN OR BX	C.12
1277370000	B2CF 3.50/22/180 SN OR BX	C.12
1277380000	B2CF 3.50/24/180 SN OR BX	C.12
1277390000	B2CF 3.50/26/180 SN OR BX	C.12
1277410000	B2CF 3.50/28/180 SN OR BX	C.12
1277420000	B2CF 3.50/30/180 SN OR BX	C.12
1277430000	B2CF 3.50/32/180 SN OR BX	C.12
1277440000	B2CF 3.50/34/180 SN OR BX	C.12
1277450000	B2CF 3.50/36/180 SN OR BX	C.12
1277460000	B2CF 3.50/38/180 SN OR BX	C.12
1277470000	B2CF 3.50/06/180 SN BK BX	C.12
1277480000	B2CF 3.50/08/180 SN BK BX	C.12
1277490000	B2CF 3.50/10/180 SN BK BX	C.12
1277510000	B2CF 3.50/12/180 SN BK BX	C.12
1277520000	B2CF 3.50/14/180 SN BK BX	C.12
1277530000	B2CF 3.50/16/180 SN BK BX	C.12
1277540000	B2CF 3.50/18/180 SN BK BX	C.12
1277550000	B2CF 3.50/20/180 SN BK BX	C.12
1277560000	B2CF 3.50/22/180 SN BK BX	C.12
1277570000	B2CF 3.50/24/180 SN BK BX	C.12
1277580000	B2CF 3.50/26/180 SN BK BX	C.12
1277590000	B2CF 3.50/28/180 SN BK BX	C.12
1277610000	B2CF 3.50/30/180 SN BK BX	C.12
1277620000	B2CF 3.50/32/180 SN BK BX	

Order No.	Type	Page
1353590000	SLF 5.08/03/180DF SN OR BX	C.208
1353600000	SLF 5.08/04/180DF SN OR BX	C.208
1353620000	SLF 5.08/05/180DF SN OR BX	C.208
1353630000	SLF 5.08/06/180DF SN OR BX	C.208
1353640000	SLF 5.08/07/180DF SN OR BX	C.208
1353650000	SLF 5.08/08/180DF SN OR BX	C.208
1353670000	SLF 5.08/09/180DF SN OR BX	C.208
1353680000	SLF 5.08/10/180DF SN OR BX	C.208
1357790000	S2C-THR 3.50/08/90G 3.2SN BK BX	C.10
1357800000	S2C-THR 3.50/12/90G 3.2SN BK BX	C.10
1357820000	S2C-THR 3.50/16/90G 3.2SN BK BX	C.10
1357830000	S2C-THR 3.50/20/90G 3.2SN BK BX	C.10
1357840000	S2C-THR 3.50/24/90G 3.2SN BK BX	C.10
1357850000	S2C-THR 3.50/28/90G 3.2SN BK BX	C.10
1357870000	S2C-THR 3.50/32/90G 3.2SN BK BX	C.10
1357880000	S2C-THR 3.50/36/90G 3.2SN BK BX	C.10
1357890000	S2C-THR 3.50/08/90LF 3.2SN BK BX	C.11
1357900000	S2C-THR 3.50/12/90LF 3.2SN BK BX	C.11
1357920000	S2C-THR 3.50/16/90LF 3.2SN BK BX	C.11
1357930000	S2C-THR 3.50/20/90LF 3.2SN BK BX	C.11
1357940000	S2C-THR 3.50/24/90LF 3.2SN BK BX	C.11
1357950000	S2C-THR 3.50/28/90LF 3.2SN BK BX	C.11
1357970000	S2C-THR 3.50/32/90LF 3.2SN BK BX	C.11
1357990000	S2C-THR 3.50/36/90LF 3.2SN BK BX	C.11
1358530000	S2C-SMT 3.50/04/180LF 3.5SN BK RL	C.9
1358540000	S2C-SMT 3.50/06/180LF 3.5SN BK RL	C.9
1358550000	S2C-SMT 3.50/08/180LF 3.5SN BK RL	C.9
1358570000	S2C-SMT 3.50/10/180LF 3.5SN BK RL	C.9
1358580000	S2C-SMT 3.50/12/180LF 3.5SN BK RL	C.9
1358590000	S2C-SMT 3.50/14/180LF 3.5SN BK RL	C.9
1358600000	S2C-SMT 3.50/16/180LF 3.5SN BK RL	C.9
1358610000	S2C-SMT 3.50/18/180LF 3.5SN BK RL	C.9
1358620000	S2C-SMT 3.50/20/180LF 3.5SN BK RL	C.9
1358630000	S2C-SMT 3.50/04/180LF 1.5SN BK RL	C.9
1358640000	S2C-SMT 3.50/06/180LF 1.5SN BK RL	C.9
1358650000	S2C-SMT 3.50/08/180LF 1.5SN BK RL	C.9
1358670000	S2C-SMT 3.50/10/180LF 1.5SN BK RL	C.9
1358680000	S2C-SMT 3.50/12/180LF 1.5SN BK RL	C.9
1358690000	S2C-SMT 3.50/14/180LF 1.5SN BK RL	C.9
1358700000	S2C-SMT 3.50/16/180LF 1.5SN BK RL	C.9
1358710000	S2C-SMT 3.50/18/180LF 1.5SN BK RL	C.9
1358720000	S2C-SMT 3.50/20/180LF 1.5SN BK RL	C.9
1358730000	S2C-SMT 3.50/04/180G 3.5SN BK RL	C.9
1358750000	S2C-SMT 3.50/08/180G 3.5SN BK RL	C.9
1358770000	S2C-SMT 3.50/10/180G 3.5SN BK RL	C.9
1358780000	S2C-SMT 3.50/12/180G 3.5SN BK RL	C.9
1358790000	S2C-SMT 3.50/14/180G 3.5SN BK RL	C.9
1358810000	S2C-SMT 3.50/16/180G 3.5SN BK RL	C.9
1358820000	S2C-SMT 3.50/18/180G 3.5SN BK RL	C.9
1358830000	S2C-SMT 3.50/20/180G 3.5SN BK RL	C.9
1358840000	S2C-SMT 3.50/22/180G 3.5SN BK RL	C.9
1358850000	S2C-SMT 3.50/24/180G 3.5SN BK RL	C.9
1358860000	S2C-SMT 3.50/04/180G 1.5SN BK RL	C.9
1358870000	S2C-SMT 3.50/06/180G 1.5SN BK RL	C.9
1358880000	S2C-SMT 3.50/08/180G 1.5SN BK RL	C.9
1358890000	S2C-SMT 3.50/10/180G 1.5SN BK RL	C.9
1358900000	S2C-SMT 3.50/12/180G 1.5SN BK RL	C.9
1358910000	S2C-SMT 3.50/14/180G 1.5SN BK RL	C.9
1358920000	S2C-SMT 3.50/16/180G 1.5SN BK RL	C.9
1358930000	S2C-SMT 3.50/18/180G 1.5SN BK RL	C.9
1358940000	S2C-SMT 3.50/20/180G 1.5SN BK RL	C.9
1359030000	S2C-SMT 3.50/16/90LF 3.2SN BK RL	C.7
1359040000	S2C-SMT 3.50/22/180G 1.5SN BK RL	C.9
1359050000	S2C-SMT 3.50/18/90LF 3.2SN BK RL	C.7
1359060000	S2C-SMT 3.50/24/180G 1.5SN BK RL	C.9
1359070000	S2C-SMT 3.50/20/90LF 3.2SN BK RL	C.7
1359080000	S2C-SMT 3.50/04/90LF 1.5SN BK RL	C.7
1359090000	S2C-SMT 3.50/06/90LF 1.5SN BK RL	C.7
1359110000	S2C-SMT 3.50/08/90LF 1.5SN BK RL	C.7
1359120000	S2C-SMT 3.50/10/90LF 1.5SN BK RL	C.7
1359130000	S2C-SMT 3.50/12/90LF 1.5SN BK RL	C.7
1359140000	S2C-SMT 3.50/14/90LF 1.5SN BK RL	C.7
1359150000	S2C-SMT 3.50/16/90LF 1.5SN BK RL	C.7
1359160000	S2C-SMT 3.50/18/90LF 1.5SN BK RL	C.7
1359170000	S2C-SMT 3.50/20/90LF 1.5SN BK RL	C.7
1359460000	S2C-SMT 3.50/04/90G 3.2SN BK RL	C.7
1359470000	S2C-SMT 3.50/06/90G 3.2SN BK RL	C.7
1359480000	S2C-SMT 3.50/08/90G 3.2SN BK RL	C.7
1359490000	S2C-SMT 3.50/10/90G 3.2SN BK RL	C.7
1359510000	S2C-SMT 3.50/12/90G 3.2SN BK RL	C.7
1359520000	S2C-SMT 3.50/14/90G 3.2SN BK RL	C.7
1359530000	S2C-SMT 3.50/16/90G 3.2SN BK RL	C.7
1359540000	S2C-SMT 3.50/18/90G 3.2SN BK RL	C.7
1359550000	S2C-SMT 3.50/20/90G 3.2SN BK RL	C.7
1359560000	S2C-SMT 3.50/22/90G 3.2SN BK RL	C.7
1359570000	S2C-SMT 3.50/24/90G 3.2SN BK RL	C.7
1359580000	S2C-SMT 3.50/04/90G 1.5SN BK RL	C.7
1359590000	S2C-SMT 3.50/06/90G 1.5SN BK RL	C.7
1359600000	S2C-SMT 3.50/08/90G 1.5SN BK RL	C.7
1359610000	S2C-SMT 3.50/10/90G 1.5SN BK RL	C.7
1359620000	S2C-SMT 3.50/12/90G 1.5SN BK RL	C.7
1359630000	S2C-SMT 3.50/14/90G 1.5SN BK RL	C.7
1359640000	S2C-SMT 3.50/16/90G 1.5SN BK RL	C.7

Order No.	Type	Page
1359650000	S2C-SMT 3.50/18/90G 1.5SN BK RL	C.7
1359670000	S2C-SMT 3.50/20/90G 1.5SN BK RL	C.7
1359680000	S2C-SMT 3.50/22/90G 1.5SN BK RL	C.7
1359690000	S2C-SMT 3.50/24/90G 1.5SN BK RL	C.7
1370000000		
1379590000	BLZF 3.50/02/180LR SN OR BX	C.49
1379600000	BL 3.50/02/180LR SN OR BX	C.45
1379610000	SL-SMT 3.50/02/90RF 1.5SN BK BX	C.29
1400000000		
1401760000	TOP4GS2/90 6.35 OR	B.50
1410000000		
1410860000	AP 85	I.46
1410960000	AP 86	I.46
1411060000	AP 85 D	I.46
1411160000	AP 86 D	I.46
1413000000	RSV1,6 B4 GR	C.265
1413100000	RSV1,6 S4 GR	C.264
1414000000	RSV1,6 B6 GR	C.265
1414100000	RSV1,6 S6 GR	C.264
1415000000	RSV1,6 B9 GR	C.265
1415100000	RSV1,6 S9 GR	C.264
1416000000	RSV1,6 B12 GR	C.265
1416100000	RSV1,6 S12 GR	C.264
1417000000	RSV1,6 B18 GR	C.265
1417100000	RSV1,6 S18 GR	C.264
1418000000	RSV1,6 B24 GR	C.265
1418100000	RSV1,6 S24 GR	C.264
1419000000	RSV1,6 B36 GR BX	C.265
1419100000	RSV1,6 S36 GR BX	C.264
1420000000		
1420500000	CS1,6R26-24 AU,75 I1,4	C.254
1420600000	CS1,6E26-24 AU,75 I1,4	C.254
1420700000	CSL1,6E26-24 AU,75 I1,4	C.254
1420800000	CB1,6R26-24 AU,75 I1,4	C.254
1420900000	CB1,6E26-24 AU,75 I1,4	C.254
1421500000	CS1,6R26-24 SN I1,4	C.254
1421600000	CS1,6E26-24 SN I1,4	C.254
1421700000	CSL1,6E26-24 SN I1,4	C.254
1421800000	CB1,6R26-24 SN I1,4	C.254
1421900000	CB1,6E26-24 SN I1,4	C.254
1422500000	CS1,6R22-20 AU,75 I1,8	C.254
1422600000	CS1,6E22-20 AU,75 I1,8	C.254
1422700000	CSL1,6E22-20 AU,75 I1,8	C.254
1422800000	CB1,6R22-20 AU,75 I1,8	C.254
1422900000	CB1,6E22-20 AU,75 I1,8	C.254
1423500000	CS1,6R22-20 SN I1,8	C.254
1423600000	CS1,6E22-20 SN I1,8	C.254
1423700000	CSL1,6E22-20 SN I1,8	C.254
1423800000	CB1,6R22-20 SN I1,8	C.254
1423900000	CB1,6E22-20 SN I1,8	C.254
1424500000	CS1,6R22-20 AU,75 I2,5	C.254
1424600000	CS1,6E22-20 AU,75 I2,5	C.254
1424700000	CSL1,6E22-20 AU,75 I2,5	C.254
1424800000	CB1,6R22-20 AU,75 I2,5	C.254
1424900000	CB1,6E22-20 AU,75 I2,5	C.254
1425600000	CS1,6R22-20 SN I2,5	C.254
1425700000	CS1,6E22-20 SN I2,5	C.254
1425800000	CSL1,6E22-20 SN I2,5	C.254
1425900000	CB1,6R22-20 SN I2,5	C.254
1426500000	CS1,6R18-16 AU,75 I2,5	C.254
1426600000	CS1,6E18-16 AU,75 I2,5	C.254
1426700000	CSL1,6E18-16 AU,75 I2,5	C.254
1426800000	CB1,6R18-16 AU,75 I2,5	C.254
1426900000	CB1,6E18-16 AU,75 I2,5	C.254
1427500000	CS1,6R18-16 SN I2,5	C.254
1427600000	CS1,6E18-16 SN I2,5	C.254
1427700000	CSL1,6E18-16 SN I2,5	C.254
1427800000	CB1,6R18-16 SN I2,5	C.254
1427900000	CB1,6E18-16 SN I2,5	C.254
1428500000	CS1,6R14-12 AU,75 I3,5	C.254
1428600000	CS1,6E14-12 AU,75 I3,5	C.254
1428700000	CSL1,6E14-12 AU,75 I3,5	C.254
1428800000	CB1,6R14-12 AU,75 I3,5	C.254
1428900000	CB1,6E14-12 AU,75 I3,5	C.254
1429500000	CS1,6R14-12 SN I3,5	C.254
1429600000	CS1,6E14-12 SN I3,5	C.254
1429700000	CSL1,6E14-12 SN I3,5	C.254
1429800000	CB1,6R14-12 SN I3,5	C.254
1429900000	CB1,6E14-12 SN I3,5	C.254
1440000000		
1440200000	RSV1,6 LB4 GR 3,2 AU	C.262
1440300000	RSV1,6 LB4 GR 3,2 SN	C.258
1440400000	RSV1,6 LS4 GR 3,2 AU	C.260
1440500000	RSV1,6 LS4 GR 3,2 SN	C.256
1440600000	RSV1,6 LBF4 GR 3,2 AU	C.263
1440700000	RSV1,6 LBF4 GR 3,2 SN	C.259
1440800000	RSV1,6 LSF4 GR 3,2 AU	C.261
1440900000	RSV1,6 LSF4 GR 3,2 SN	C.257

Order No.	Type	Page
1441200000	RSV1,6 LB6 GR 3,2 AU	C.262
1441300000	RSV1,6 LB6 GR 3,2 SN	C.258
1441400000	RSV1,6 LS6 GR 3,2 AU	C.260
1441500000	RSV1,6 LS6 GR 3,2 SN	C.256
1441600000	RSV1,6 LBF6 GR 3,2 AU	C.263
1441700000	RSV1,6 LBF6 GR 3,2 SN	C.259
1441800000	RSV1,6 LSF6 GR 3,2 AU	C.261
1441900000	RSV1,6 LSF6 GR 3,2 SN	C.257
1442200000	RSV1,6 LB9 GR 3,2 AU	C.262
1442300000	RSV1,6 LB9 GR 3,2 SN	C.258
1442400000	RSV1,6 LS9 GR 3,2 AU	C.260
1442500000	RSV1,6 LS9 GR 3,2 SN	C.256
1442600000	RSV1,6 LBF9 GR 3,2 AU	C.263
1442700000	RSV1,6 LBF9 GR 3,2 SN	C.259
1442800000	RSV1,6 LSF9 GR 3,2 AU	C.261
1442900000	RSV1,6 LSF9 GR 3,2 SN	C.257
1443200000	RSV1,6 LB12 GR 3,2 AU	C.262
1443300000	RSV1,6 LB12 GR 3,2 SN	C.258
1443400000	RSV1,6 LS12 GR 3,2 AU	C.260
1443500000	RSV1,6 LS12 GR 3,2 SN	C.256
1443600000	RSV1,6 LBF12 GR 3,2 AU	C.263
1443700000	RSV1,6 LBF12 GR 3,2 SN	C.259
1443800000	RSV1,6 LSF12 GR 3,2 AU	C.261
1443900000	RSV1,6 LSF12 GR 3,2 SN	C.257
1444200000	RSV1,6 LB18 GR 3,2 AU	C.262
1444300000	RSV1,6 LB18 GR 3,2 SN	C.258
1444400000	RSV1,6 LS18 GR 3,2 AU	C.260
1444500000	RSV1,6 LS18 GR 3,2 SN	C.256
1444600000	RSV1,6 LBF18 GR 3,2 AU	C.263
1444700000	RSV1,6 LBF18 GR 3,2 SN	C.259
1444800000	RSV1,6 LSF18 GR 3,2 AU	C.261
1444900000	RSV1,6 LSF18 GR 3,2 SN	C.257
1445200000	RSV1,6 LB24 GR 3,2 AU	C.262
1445300000	RSV1,6 LB24 GR 3,2 SN	C.258
1445400000	RSV1,6 LS24 GR 3,2 AU	C.260
1445500000	RSV1,6 LS24 GR 3,2 SN	C.256
1445600000	RSV1,6 LBF24 GR 3,2 AU	C.263
1445700000	RSV1,6 LBF24 GR 3,2 SN	C.259
1445800000	RSV1,6 LSF24 GR 3,2 AU	C.261
1445900000	RSV1,6 LSF24 GR 3,2 SN	C.257
1446060000	SLA B8B RH OR	C.212
1446200000	RSV1,6 LB36 GR 3,2 AU	C.262
1446300000	RSV1,6 LB36 GR 3,2 SN	C.258
1446400000	RSV1,6 LS36 GR 3,2 AU	C.260
1446500000	RSV1,6 LS36 GR 3,2 SN	C.256
1446600000	RSV1,6 LBF36 GR 3,2 AU	C.263
1446700000	RSV1,6 LBF36 GR 3,2 SN	C.259
1446800000	RSV1,6 LSF36 GR 3,2 AU	C.261
1446900000	RSV1,6 LSF36 GR 3,2 SN	C.257
1470000000		
1472200000	LPA QB 2	D.15
1472300000	LPA QB 3	D.15
1472400000	LPA QB 4	D.15
1472500000	LPA QB 10	D.15
1472600000	LPA QB 24	D.15
1474660000	TOP1.5GS9/180 5 2STI OR	B.47
1474760000	TOP1.5GS11/180 5 2STI OR	B.47
1480000000		
1480000000	DFFC 0.5-1.0 SN 3000	C.248
1480100000	DFFC 1.5-2.5 SN 2500	C.2

Order No.	Type	Page
1500460000	BLT 5.08/11/180 SN OR BX	C.226
1500510000	BLT 5.08/12/180 SN BK BX	C.226
1500560000	BLT 5.08/12/180 SN OR BX	C.226
1500610000	BLT 5.08/13/180 SN BK BX	C.226
1500660000	BLT 5.08/13/180 SN OR BX	C.226
1500710000	BLT 5.08/14/180 SN BK BX	C.226
1500760000	BLT 5.08/14/180 SN OR BX	C.226
1500810000	BLT 5.08/15/180 SN BK BX	C.226
1500860000	BLT 5.08/15/180 SN OR BX	C.226
1500910000	BLT 5.08/16/180 SN BK BX	C.226
1500960000	BLT 5.08/16/180 SN OR BX	C.226
1501010000	BLT 5.08/17/180 SN BK BX	C.226
1501060000	BLT 5.08/17/180 SN OR BX	C.226
1501110000	BLT 5.08/18/180 SN BK BX	C.226
1501160000	BLT 5.08/18/180 SN OR BX	C.226
1501210000	BLT 5.08/19/180 SN BK BX	C.226
1501260000	BLT 5.08/19/180 SN OR BX	C.226
1501310000	BLT 5.08/20/180 SN BK BX	C.226
1501360000	BLT 5.08/20/180 SN OR BX	C.226
1501410000	BLT 5.08/21/180 SN BK BX	C.226
1501460000	BLT 5.08/21/180 SN OR BX	C.226
1501510000	BLT 5.08/22/180 SN BK BX	C.226
1501560000	BLT 5.08/22/180 SN OR BX	C.226
1501610000	BLT 5.08/23/180 SN BK BX	C.226
1501660000	BLT 5.08/23/180 SN OR BX	C.226
1501710000	BLT 5.08/24/180 SN BK BX	C.226
1501760000	BLT 5.08/24/180 SN OR BX	C.226

1530000000

1539860000	TOP1.56S BB OR	D.7
------------	----------------	-----

1540000000

1545710000	BLZ/SL KO SW	D.11
------------	--------------	------

1560000000

1563000000	RSV1.6 ZE 36 SW	D.3
1563100000	RSV1.6 ZE 24 SW	D.3
1563200000	RSV1.6 ZE 18 SW	D.3
1563300000	RSV1.6 ZE 12 SW	D.3
1563400000	RSV1.6 ZE 9 SW	D.3
1563500000	RSV1.6 ZE 6 SW	D.3
1563600000	RSV1.6 ZE 4 SW	D.3
1565760000	CSL1.6R14-12 AU,75 I3,5	C.254
1565780000	CSL1.6R14-12 SN I3,5	C.254
1565790000	CSL1.6R18-16 AU,75 I2,5	C.254
1565810000	CSL1.6R18-16 SN I2,5	C.254
1565820000	CSL1.6R22-20 AU,75 I2,5	C.254
1565840000	CSL1.6R22-20 SN I2,5	C.254
1565850000	CSL1.6R22-20 AU,75 I1,8	C.254
1565870000	CSL1.6R22-20 SN I1,8	C.254
1565880000	CSL1.6R26-24 AU,75 I1,4	C.254
1565900000	CSL1.6R26-24 SN I1,4	C.254
1567060000	DFFC 0.5-1.0 SN E	C.248
1567070000	DFFC 1.5-2.5 SN E	C.248
1567430000	RSV1.6 KO	D.11

1570000000

1571110000	SL 5.00/12/90 3.2SN OR BX	C.144
1571130000	SL 5.00/02/90 3.2SN OR BX	C.144
1571140000	SL 5.00/03/90 3.2SN OR BX	C.144
1571150000	SL 5.00/04/90 3.2SN OR BX	C.144
1571160000	SL 5.00/05/90 3.2SN OR BX	C.144
1571170000	SL 5.00/06/90 3.2SN OR BX	C.144
1571180000	SL 5.00/07/90 3.2SN OR BX	C.144
1571190000	SL 5.00/08/90 3.2SN OR BX	C.144
1571200000	SL 5.00/09/90 3.2SN OR BX	C.144
1571210000	SL 5.00/10/90 3.2SN OR BX	C.144
1571220000	SL 5.00/11/90 3.2SN OR BX	C.144
1571230000	SL 5.00/13/90 3.2SN OR BX	C.144
1571240000	SL 5.00/14/90 3.2SN OR BX	C.144
1571250000	SL 5.00/15/90 3.2SN OR BX	C.144
1571260000	SL 5.00/16/90 3.2SN OR BX	C.144
1571270000	SL 5.00/17/90 3.2SN OR BX	C.144
1571280000	SL 5.00/18/90 3.2SN OR BX	C.144
1571290000	SL 5.00/19/90 3.2SN OR BX	C.144
1571300000	SL 5.00/20/90 3.2SN OR BX	C.144
1571310000	SL 5.00/21/90 3.2SN OR BX	C.144
1571320000	SL 5.00/22/90 3.2SN OR BX	C.144
1571330000	SL 5.00/23/90 3.2SN OR BX	C.144
1571340000	SL 5.00/24/90 3.2SN OR BX	C.144
1571700000	TOP4GS9/180 7.6Z OR	B.53
1571720000	SLA BB4 OR	C.212
1573010000	BLZ/SL KO OR	D.11
1577980000	BLAT ZE4 OR	D.2
1578010000	BLAT ZE8 OR	D.2
1579820000	TOP1.56S/90 5 2STI OR	B.46

1580000000

1580100000	SL FLA 1.5/1	D.9
1580110000	SL FLA 3.8/1	D.9
1580120000	SL FLA 9.0/1	D.9
1580860000	SL 5.00/02/90B 3.2SN OR BX	C.145
1580870000	SL 5.00/03/90B 3.2SN OR BX	C.145
1580880000	SL 5.00/04/90B 3.2SN OR BX	C.145

Order No.	Type	Page
1580890000	SL 5.00/05/90B 3.2SN OR BX	C.145
1580900000	SL 5.00/06/90B 3.2SN OR BX	C.145
1580910000	SL 5.00/07/90B 3.2SN OR BX	C.145
1580920000	SL 5.00/08/90B 3.2SN OR BX	C.145
1580930000	SL 5.00/09/90B 3.2SN OR BX	C.145
1580940000	SL 5.00/10/90B 3.2SN OR BX	C.145
1580950000	SL 5.00/11/90B 3.2SN OR BX	C.145
1580960000	SL 5.00/12/90B 3.2SN OR BX	C.145
1580970000	SL 5.00/13/90B 3.2SN OR BX	C.145
1580980000	SL 5.00/14/90B 3.2SN OR BX	C.145
1580990000	SL 5.00/15/90B 3.2SN OR BX	C.145
1581000000	SL 5.00/16/90B 3.2SN OR BX	C.145
1581010000	SL 5.00/17/90B 3.2SN OR BX	C.145
1581020000	SL 5.00/18/90B 3.2SN OR BX	C.145
1581030000	SL 5.00/19/90B 3.2SN OR BX	C.145
1581040000	SL 5.00/20/90B 3.2SN OR BX	C.145
1581050000	SL 5.00/21/90B 3.2SN OR BX	C.145
1581060000	SL 5.00/22/90B 3.2SN OR BX	C.145
1581070000	SL 5.00/23/90B 3.2SN OR BX	C.145
1581080000	SL 5.00/24/90B 3.2SN OR BX	C.145
1581320000	SL 5.00/02/180 3.2SN OR BX	C.146
1581330000	SL 5.00/03/180 3.2SN OR BX	C.146
1581340000	SL 5.00/04/180 3.2SN OR BX	C.146
1581350000	SL 5.00/05/180 3.2SN OR BX	C.146
1581360000	SL 5.00/06/180 3.2SN OR BX	C.146
1581370000	SL 5.00/07/180 3.2SN OR BX	C.146
1581380000	SL 5.00/08/180 3.2SN OR BX	C.146
1581390000	SL 5.00/09/180 3.2SN OR BX	C.146
1581400000	SL 5.00/10/180 3.2SN OR BX	C.146
1581410000	SL 5.00/11/180 3.2SN OR BX	C.146
1581420000	SL 5.00/12/180 3.2SN OR BX	C.146
1581430000	SL 5.00/13/180 3.2SN OR BX	C.146
1581440000	SL 5.00/14/180 3.2SN OR BX	C.146
1581450000	SL 5.00/15/180 3.2SN OR BX	C.146
1581460000	SL 5.00/16/180 3.2SN OR BX	C.146
1581470000	SL 5.00/17/180 3.2SN OR BX	C.146
1581480000	SL 5.00/18/180 3.2SN OR BX	C.146
1581490000	SL 5.00/19/180 3.2SN OR BX	C.146
1581500000	SL 5.00/20/180 3.2SN OR BX	C.146
1581510000	SL 5.00/21/180 3.2SN OR BX	C.146
1581520000	SL 5.00/22/180 3.2SN OR BX	C.146
1581530000	SL 5.00/23/180 3.2SN OR BX	C.146
1581540000	SL 5.00/24/180 3.2SN OR BX	C.146
1581780000	SL 5.00/02/180B 3.2SN OR BX	C.147
1581790000	SL 5.00/03/180B 3.2SN OR BX	C.147
1581800000	SL 5.00/04/180B 3.2SN OR BX	C.147
1581810000	SL 5.00/05/180B 3.2SN OR BX	C.147
1581820000	SL 5.00/06/180B 3.2SN OR BX	C.147
1581830000	SL 5.00/07/180B 3.2SN OR BX	C.147
1581840000	SL 5.00/08/180B 3.2SN OR BX	C.147
1581850000	SL 5.00/09/180B 3.2SN OR BX	C.147
1581860000	SL 5.00/10/180B 3.2SN OR BX	C.147
1581870000	SL 5.00/11/180B 3.2SN OR BX	C.147
1581880000	SL 5.00/12/180B 3.2SN OR BX	C.147
1581890000	SL 5.00/13/180B 3.2SN OR BX	C.147
1581900000	SL 5.00/14/180B 3.2SN OR BX	C.147
1581910000	SL 5.00/15/180B 3.2SN OR BX	C.147
1581920000	SL 5.00/16/180B 3.2SN OR BX	C.147
1581930000	SL 5.00/17/180B 3.2SN OR BX	C.147
1581940000	SL 5.00/18/180B 3.2SN OR BX	C.147
1581950000	SL 5.00/19/180B 3.2SN OR BX	C.147
1581960000	SL 5.00/20/180B 3.2SN OR BX	C.147
1581970000	SL 5.00/21/180B 3.2SN OR BX	C.147
1581980000	SL 5.00/22/180B 3.2SN OR BX	C.147
1581990000	SL 5.00/23/180B 3.2SN OR BX	C.147
1582000000	SL 5.00/24/180B 3.2SN OR BX	C.147
1582250000	CS1.6E18-16 AU,75 I3,5	C.254
1582260000	CS1.6R18-16 AU,75 I3,5	C.254
1582270000	CS1.6E18-16 SN I3,5	C.254
1582280000	CS1.6R18-16 SN I3,5	C.254
1582290000	CS1.6E14-12 AU,75 I4,2	C.254
1582300000	CS1.6R14-12 AU,75 I4,2	C.254
1582310000	CS1.6E14-12 SN I4,2	C.254
1582320000	CS1.6R14-12 SN I4,2	C.254
1582330000	CS1.6E18-16 AU,75 I3,5	C.254
1582340000	CS1.6R18-16 AU,75 I3,5	C.254
1582350000	CS1.6E18-16 SN I3,5	C.254
1582360000	CS1.6R18-16 SN I3,5	C.254
1582370000	CS1.6E14-12 AU,75 I4,2	C.254
1582380000	CS1.6R14-12 AU,75 I4,2	C.254
1582390000	CS1.6E14-12 SN I4,2	C.254
1582400000	CS1.6R14-12 SN I4,2	C.254
1582410000	CB1.6E18-16 AU,75 I3,5	C.254
1582420000	CB1.6R18-16 AU,75 I3,5	C.254
1582430000	CB1.6E18-16 SN I3,5	C.254
1582440000	CB1.6R18-16 SN I3,5	C.254
1582450000	CB1.6E14-12 AU,75 I4,2	C.254
1582460000	CB1.6R14-12 AU,75 I4,2	C.254
1582470000	CB1.6E14-12 SN I4,2	C.254
1582480000	CB1.6R14-12 SN I4,2	C.254
1582910000	RSV1.6 RF4/35x7.5 SW	D.3
1582920000	RSV1.6 RF6/35x7.5 SW	D.3
1582930000	RSV1.6 RF9/35x7.5 SW	D.3
1582940000	RSV1.6 RF12/35x7.5 SW	D.3
1582950000	RSV1.6 RF18/35x7.5 SW	D.3
1582960000	RSV1.6 RF24/35x7.5 SW	D.3
1582970000	RSV1.6 RF36/35x7.5 SW	D.3
1584770000	LPA QB 17	D.15

1590000000

1593450000	SLA BB12R OR	D.6
1594200000	SLA BB14 OR	D.7
1594340000	LPP 5.00/02/90 3.2SN OR BX	B.24
1594350000	LPP 5.00/03/90 3.2SN OR BX	B.24
1594400000	LPP 5.08/02/90 3.2SN OR BX	B.26
1594410000	LPP 5.08/03/90 3.2SN OR BX	B.26
1594420000	LP 7.50/02/90 3.2SN OR BX	B.34
1594430000	LP 7.50/03/90 3.2SN OR BX	B.34
1594440000	LPP 7.50/02/90 3.2SN OR BX	B.35
1594450000	LPP 7.50/03/90 3.2SN OR BX	B.35
1594460000	LP 7.62/02/90 3.2SN OR BX	B.36
1594470000	LP 7.62/03/90 3.2SN OR BX	B.36
1594480000	LPP 7.62/02/90 3.2SN OR BX	B.37
1594490000	LPP 7.62/03/90 3.2SN OR BX	B.37
1595690000	LP 5.08/03/135 3.2 OR	B.27
1595710000	LP5.00/3/135 3.2 OR	B.25
1595730000	LP 5.08/02/135 3.2 OR	B.27
1595750000	LP5.00/2/135 3.2 OR	B.25
1595770000	LP7.50/2/135 3.2 OR	B.35
1595790000	LP7.62/2/135 3.2 OR	B.37
1595810000	LP7.50/3/135 3.2 OR	B.35
1595830000	LP7.62/3/135 3.2 OR	B.37
1595850000	SL FLA 1.5/24	D.9
1595860000	SL FLA 3.8/24	D.9
1595870000	SL FLA 9.0/24	D.9
1596320000	LP3R 5.08/09/90 3.2SN OR BX	B.32
1596340000	LP3R 5.08/12/90 3.2SN OR BX	B.32
1596360000	LP3R 5.08/15/90 3.2SN OR BX	B.32
1596380000	LP3R 5.08/18/90 3.2SN OR BX	B.32
1596400000	LP3R 5.08/24/90 3.2SN OR BX	B.32
1596420000	LP3R 5.08/30/90 3.2SN OR BX	B.32
1596450000	LP2N 5.00/08/90 3.2SN OR BX	B.29
1596460000	LP2N 5.08/08/90 3.2SN OR BX	B.31
1596490000	LP2N 5.00/10/90 3.2SN OR BX	B.29
1596510000	LP2N 5.08/10/90 3.2SN OR BX	B.31
1596530000	LP2N 5.08/16/90 3.2SN OR BX	B.31
1596550000	LP2N 5.00/16/90 3.2SN OR BX	B.29
1596570000	LP2N 5.08/20/90 3.2SN OR BX	B.31
1596590000	LP2N 5.00/20/90 3.2SN OR BX	B.29
1596610000	LP2N 5.08/24/90 3.2SN OR BX	B.31
1596630000	LP2N 5.00/24/90 3.2SN OR BX	B.29
1596650000	LP2N 5.08/30/90 3.2SN OR BX	B.31
1596670000	LP2N 5.00/30/90 3.2SN OR BX	B.29
1597060000	TOP1.56S/180 7 2STI OR	B.49
1597070000		

Order No.	Type	Page
1776364001	SL-SMT 5.08/02/180LF 1.5 SN BK RL	C.179
1776372001	SL-SMT 5.08/03/180LF 1.5 SN BK BX	C.178
1776374001	SL-SMT 5.08/03/180LF 1.5 SN BK RL	C.179
1776382001	SL-SMT 5.08/04/180LF 1.5 SN BK BX	C.178
1776384001	SL-SMT 5.08/04/180LF 1.5 SN BK RL	C.179
1776392001	SL-SMT 5.08/05/180LF 1.5 SN BK BX	C.178
1776394001	SL-SMT 5.08/05/180LF 1.5 SN BK RL	C.179
1776402001	SL-SMT 5.08/06/180LF 1.5 SN BK BX	C.178
1776404001	SL-SMT 5.08/06/180LF 1.5 SN BK RL	C.179
1776412001	SL-SMT 5.08/07/180LF 1.5 SN BK BX	C.178
1776422001	SL-SMT 5.08/08/180LF 1.5 SN BK BX	C.178
1776432001	SL-SMT 5.08/09/180LF 1.5 SN BK BX	C.178
1776442001	SL-SMT 5.08/10/180LF 1.5 SN BK BX	C.178
1776452001	SL-SMT 5.08/11/180LF 1.5 SN BK BX	C.178
1776462001	SL-SMT 5.08/12/180LF 1.5 SN BK BX	C.178
1776472001	SL-SMT 5.08/13/180LF 1.5 SN BK BX	C.178
1776482001	SL-SMT 5.08/14/180LF 1.5 SN BK BX	C.178
1776492001	SL-SMT 5.08/15/180LF 1.5 SN BK BX	C.178
1776502001	SL-SMT 5.08/16/180LF 1.5 SN BK BX	C.178
1776512001	SL-SMT 5.08/17/180LF 1.5 SN BK BX	C.178
1776522001	SL-SMT 5.08/18/180LF 1.5 SN BK BX	C.178
1776532001	SL-SMT 5.08/19/180LF 1.5 SN BK BX	C.178
1776542001	SL-SMT 5.08/20/180LF 1.5 SN BK BX	C.178
1776552001	SL-SMT 5.08/21/180LF 1.5 SN BK BX	C.178
1776572001	SL-SMT 5.08/22/180LF 1.5 SN BK BX	C.178
1776582001	SL-SMT 5.08/23/180LF 1.5 SN BK BX	C.178
1776592001	SL-SMT 5.08/24/180LF 1.5 SN BK BX	C.178
1779880000	BL/V 3.50/10F SN BK BX	C.52
1779920000	BL/V 3.50/30F SN BK BX	C.53
1779950000	SL-SMT 5.08/02/90 3.2SN BK BX	C.168
1779960000	SL-SMT 5.08/03/90 3.2SN BK BX	C.168
1779970000	SL-SMT 5.08/04/90 3.2SN BK BX	C.168
1779980000	SL-SMT 5.08/05/90 3.2SN BK BX	C.168
1779990000	SL-SMT 5.08/06/90 3.2SN BK BX	C.168

1780000000

1780000000	SL-SMT 5.08/07/90 3.2SN BK BX	C.168
1780010000	SL-SMT 5.08/08/90 3.2SN BK BX	C.168
1780020000	SL-SMT 5.08/09/90 3.2SN BK BX	C.168
1780030000	SL-SMT 5.08/10/90 3.2SN BK BX	C.168
1780040000	SL-SMT 5.08/11/90 3.2SN BK BX	C.168
1780050000	SL-SMT 5.08/12/90 3.2SN BK BX	C.168
1780060000	SL-SMT 5.08/13/90 3.2SN BK BX	C.168
1780070000	SL-SMT 5.08/14/90 3.2SN BK BX	C.168
1780080000	SL-SMT 5.08/15/90 3.2SN BK BX	C.168
1780090000	SL-SMT 5.08/16/90 3.2SN BK BX	C.168
1780100000	SL-SMT 5.08/17/90 3.2SN BK BX	C.168
1780110000	SL-SMT 5.08/18/90 3.2SN BK BX	C.168
1780120000	SL-SMT 5.08/19/90 3.2SN BK BX	C.168
1780130000	SL-SMT 5.08/20/90 3.2SN BK BX	C.168
1780140000	SL-SMT 5.08/21/90 3.2SN BK BX	C.168
1780150000	SL-SMT 5.08/22/90 3.2SN BK BX	C.168
1780160000	SL-SMT 5.08/23/90 3.2SN BK BX	C.168
1780170000	SL-SMT 5.08/24/90 3.2SN BK BX	C.168
1780180000	SL-SMT 5.08/02/90G 3.2SN BK BX	C.169
1780190000	SL-SMT 5.08/03/90G 3.2SN BK BX	C.169
1780200000	SL-SMT 5.08/04/90G 3.2SN BK BX	C.169
1780210000	SL-SMT 5.08/05/90G 3.2SN BK BX	C.169
1780220000	SL-SMT 5.08/06/90G 3.2SN BK BX	C.169
1780230000	SL-SMT 5.08/07/90G 3.2SN BK BX	C.169
1780240000	SL-SMT 5.08/08/90G 3.2SN BK BX	C.169
1780250000	SL-SMT 5.08/09/90G 3.2SN BK BX	C.169
1780260000	SL-SMT 5.08/10/90G 3.2SN BK BX	C.169
1780270000	SL-SMT 5.08/11/90G 3.2SN BK BX	C.169
1780280000	SL-SMT 5.08/12/90G 3.2SN BK BX	C.169
1780290000	SL-SMT 5.08/13/90G 3.2SN BK BX	C.169
1780300000	SL-SMT 5.08/14/90G 3.2SN BK BX	C.169
1780310000	SL-SMT 5.08/15/90G 3.2SN BK BX	C.169
1780320000	SL-SMT 5.08/16/90G 3.2SN BK BX	C.169
1780330000	SL-SMT 5.08/17/90G 3.2SN BK BX	C.169
1780340000	SL-SMT 5.08/18/90G 3.2SN BK BX	C.169
1780350000	SL-SMT 5.08/19/90G 3.2SN BK BX	C.169
1780360000	SL-SMT 5.08/20/90G 3.2SN BK BX	C.169
1780370000	SL-SMT 5.08/21/90G 3.2SN BK BX	C.169
1780380000	SL-SMT 5.08/22/90G 3.2SN BK BX	C.169
1780390000	SL-SMT 5.08/23/90G 3.2SN BK BX	C.169
1780400000	SL-SMT 5.08/24/90G 3.2SN BK BX	C.169
1780410000	SL-SMT 5.08/02/90LF 3.2SN BK BX	C.172
1780420000	SL-SMT 5.08/03/90LF 3.2SN BK BX	C.172
1780430000	SL-SMT 5.08/04/90LF 3.2SN BK BX	C.172
1780440000	SL-SMT 5.08/05/90LF 3.2SN BK BX	C.172
1780450000	SL-SMT 5.08/06/90LF 3.2SN BK BX	C.172
1780460000	SL-SMT 5.08/07/90LF 3.2SN BK BX	C.172
1780470000	SL-SMT 5.08/08/90LF 3.2SN BK BX	C.172
1780480000	SL-SMT 5.08/09/90LF 3.2SN BK BX	C.172
1780490000	SL-SMT 5.08/10/90LF 3.2SN BK BX	C.172
1780500000	SL-SMT 5.08/11/90LF 3.2SN BK BX	C.172
1780510000	SL-SMT 5.08/12/90LF 3.2SN BK BX	C.172
1780540000	SL-SMT 5.08/13/90LF 3.2SN BK BX	C.172
1780550000	SL-SMT 5.08/14/90LF 3.2SN BK BX	C.172
1780560000	SL-SMT 5.08/15/90LF 3.2SN BK BX	C.172
1780570000	SL-SMT 5.08/16/90LF 3.2SN BK BX	C.172
1780580000	SL-SMT 5.08/17/90LF 3.2SN BK BX	C.172
1780590000	SL-SMT 5.08/18/90LF 3.2SN BK BX	C.172
1780600000	SL-SMT 5.08/19/90LF 3.2SN BK BX	C.172
1780610000	SL-SMT 5.08/20/90LF 3.2SN BK BX	C.172
1780620000	SL-SMT 5.08/21/90LF 3.2SN BK BX	C.172
1780630000	SL-SMT 5.08/22/90LF 3.2SN BK BX	C.172

Order No.	Type	Page
1780640000	SL-SMT 5.08/23/90LF 3.2SN BK BX	C.172
1780650000	SL-SMT 5.08/24/90LF 3.2SN BK BX	C.172
1781560000	B2L 3.50-AH 6 SW	D.4
1781570000	B2L 3.50-AH 8 SW	D.4
1781580000	B2L 3.50-AH 10 SW	D.4
1781590000	B2L 3.50-AH 12 SW	D.4
1781600000	B2L 3.50-AH 14 SW	D.4
1781610000	B2L 3.50-AH 16 SW	D.4
1781620000	B2L 3.50-AH 18 SW	D.4
1781630000	B2L 3.50-AH 20 SW	D.4
1781640000	B2L 3.50-AH 22 SW	D.4
1781650000	B2L 3.50-AH 24 SW	D.4
1781660000	B2L 3.50-AH 26 SW	D.4
1781670000	B2L 3.50-AH 28 SW	D.4
1781680000	B2L 3.50-AH 30 SW	D.4
1781690000	B2L 3.50-AH 32 SW	D.4
1781700000	B2L 3.50-AH 34 SW	D.4
1781710000	B2L 3.50-AH 36 SW	D.4
1782490000	TOP1.56S15/180 5.2ST OR	B.47
1782500000	LM2NZF 5.08/26/135 3.5SN OR BX	B.102
1782510000	LM2NZF 5.08/28/135 3.5SN OR BX	B.102
1782520000	LM2NZF 5.08/30/135 3.5SN OR BX	B.102
1782530000	LM2NZF 5.08/32/135 3.5SN OR BX	B.102
1782540000	LM2NZF 5.08/34/135 3.5SN OR BX	B.102
1782550000	LM2NZF 5.08/36/135 3.5SN OR BX	B.102
1786030000	TOP4GS4/90 6.35 OR	B.50
1786040000	TOP4GS6/90 6.35 OR	B.50
1786050000	TOP4GS6/90 6.35 OR	B.50
1786060000	TOP4GS7/90 6.35 OR	B.50
1786070000	TOP4GS9/90 6.35 OR	B.50
1786080000	TOP4GS10/90 6.35 OR	B.50
1786090000	TOP4GS11/90 6.35 OR	B.50
1786100000	TOP4GS12/90 6.35 OR	B.50
1786190000	TOP4GS2/180 6.35 OR	B.51
1786200000	TOP4GS3/180 6.35 OR	B.51
1786210000	TOP4GS4/180 6.35 OR	B.51
1786220000	TOP4GS5/180 6.35 OR	B.51
1786230000	TOP4GS6/180 6.35 OR	B.51
1786240000	TOP4GS7/180 6.35 OR	B.51
1786250000	TOP4GS8/180 6.35 OR	B.51
1786260000	TOP4GS9/180 6.35 OR	B.51
1786270000	TOP4GS10/180 6.35 OR	B.51
1786280000	TOP4GS11/180 6.35 OR	B.51
1786290000	TOP4GS12/180 6.35 OR	B.51
1786410000	TOP4GS6/90 7.62 OR	B.52
1786420000	TOP4GS8/90 7.62 OR	B.52
1786430000	TOP4GS9/90 7.62 OR	B.52
1786440000	TOP4GS10/90 7.62 OR	B.52
1786450000	TOP4GS12/90 7.62 OR	B.52
1786540000	TOP4GS5/180 7.62 OR	B.53
1786550000	TOP4GS7/180 7.62 OR	B.53
1786560000	TOP4GS8/180 7.62 OR	B.53
1786570000	TOP4GS10/180 7.62 OR	B.53
1786580000	TOP4GS11/180 7.62 OR	B.53
1789090000	BL/V 3.50/10F PNP LED SN BK BX	C.54
1789110000	BL/V 3.50/30F PNP LED SN BK BX	C.55

1790000000

1791610000	PM 5.00/02/90 3.5SN OR BX	B.56
1791620000	PM 5.00/03/90 3.5SN OR BX	B.56
1791710000	LP5.00/4/135 3.2 OR	B.25
1792770000	BCZ 3.81/02/180 SN BK BX	C.106
1792780000	BCZ 3.81/03/180 SN BK BX	C.106
1792790000	BCZ 3.81/04/180 SN BK BX	C.106
1792800000	BCZ 3.81/05/180 SN BK BX	C.106
1792810000	BCZ 3.81/06/180 SN BK BX	C.106
1792820000	BCZ 3.81/08/180 SN BK BX	C.106
1792830000	BCZ 3.81/10/180 SN BK BX	C.106
1792840000	BCZ 3.81/12/180 SN BK BX	C.106
1792850000	BCZ 3.81/16/180 SN BK BX	C.106
1792950000	BCZ 3.81/02/180F SN BK BX	C.107
1792960000	BCZ 3.81/03/180F SN BK BX	C.107
1792970000	BCZ 3.81/04/180F SN BK BX	C.107
1792980000	BCZ 3.81/05/180F SN BK BX	C.107
1792990000	BCZ 3.81/06/180F SN BK BX	C.107
1793000000	BCZ 3.81/08/180F SN BK BX	C.107
1793010000	BCZ 3.81/10/180F SN BK BX	C.107
1793020000	BCZ 3.81/12/180F SN BK BX	C.107
1793030000	BCZ 3.81/16/180F SN BK BX	C.107
1793130000	SC 3.81/02/90G 3.2SN BK BX	C.84
1793140000	SC 3.81/03/90G 3.2SN BK BX	C.84
1793150000	SC 3.81/04/90G 3.2SN BK BX	C.84
1793160000	SC 3.81/05/90G 3.2SN BK BX	C.84
1793170000	SC 3.81/06/90G 3.2SN BK BX	C.84
1793180000	SC 3.81/08/90G 3.2SN BK BX	C.84
1793190000	SC 3.81/10/90G 3.2SN BK BX	C.84
1793200000	SC 3.81/12/90G 3.2SN BK BX	C.84
1793210000	SC 3.81/16/90G 3.2SN BK BX	C.84
1793300000	SC 3.81/02/90F 3.2SN BK BX	C.85
1793340000	SC 3.81/03/90F 3.2SN BK BX	C.85
1793350000	SC 3.81/04/90F 3.2SN BK BX	C.85
1793360000	SC 3.81/05/90F 3.2SN BK BX	C.85
1793370000	SC 3.81/06/90F 3.2SN BK BX	C.85
1793380000	SC 3.81/08/90F 3.2SN BK BX	C.85
1793390000	SC 3.81/10/90F 3.2SN BK BX	C.85
1793400000	SC 3.81/12/90F 3.2SN BK BX	C.85
1793410000	SC 3.81/16/90F 3.2SN BK BX	C.85
1793520000	SC 3.81/02/180G 3.2SN BK BX	C.86

Order No.	Type	Page
1793530000	SC 3.81/03/180G 3.2SN BK BX	C.86
1793540000	SC 3.81/04/180G 3.2SN BK BX	C.86
1793550000	SC 3.81/05/180G 3.2SN BK BX	C.86
1793560000	SC 3.81/06/180G 3.2SN BK BX	C.86
1793570000	SC 3.81/08/180G 3.2SN BK BX	C.86
1793580000	SC 3.81/10/180G 3.2SN BK BX	C.86
1793590000	SC 3.81/12/180G 3.2SN BK BX	C.86
1793600000	SC 3.81/16/180G 3.2SN BK BX	C.86
1793700000	SC 3.81/02/180F 3.2SN BK BX	C.87
1793710000	SC 3.81/03/180F 3.2SN BK BX	C.87
1793720000	SC 3.81/04/180F 3.2SN BK BX	C.87
1793730000	SC 3.81/05/180F 3.2SN BK BX	C.87
1793740000	SC 3.81/06/180F 3.2SN BK BX	C.87
1793750000	SC 3.81/08/180F 3.2SN BK BX	C.87
1793760000	SC 3.81/10/180F 3.2SN BK BX	C.87
1793770000	SC 3.81/12/180F 3.2SN BK BX	C.87
1793780000	SC 3.81/16/180F 3.2SN BK BX	C.87
1793950000	ZQV 4N/2 RT	I.38
1793960000	ZQV 4N/2 BL	I.38
1796480000	SL-SMT 5.00/02/180 1.5SN BK BX	C.138
1796490000	SL-SMT 5.00/03/180 1.5SN BK BX	C.138
1796500000	SL-SMT 5.00/04/180 1.5SN BK BX	C.138
1796510000	SL-SMT 5.00/05/180 1.5SN BK BX	C.138
1796520000	SL-SMT 5.00/06/180 1.5SN BK BX	C.138
1796530000	SL-SMT 5.00/07/180 1.5SN BK BX	C.138
1796540000	SL-SMT 5.00/08/180 1.5SN BK BX	C.138
1796550000	SL-SMT 5.00/09/180 1.5SN BK BX	C.138
1796560000	SL-SMT 5.00/10/180 1.5SN BK BX	C.138
1796570000	SL-SMT 5.00/11/180 1.5SN BK BX	C.138
1796580000	SL-SMT 5.00/12/180 1.5SN BK BX	C.138
1796590000	SL-SMT 5.00/13/180 1.5SN BK BX	C.138
1796600000	SL-SMT 5.00/14/180 1.5SN BK BX	C.138
1796610000	SL-SMT 5.00/15/180 1.5SN BK BX	C.138

Order No.	Type	Page
1928500000	BVL 7.62HP/02/90SFI 3.5SN BK BX	F.71
1928510000	BVL 7.62HP/03/90SFI 3.5SN BK BX	F.71
1928520000	BVL 7.62HP/04/90SFI 3.5SN BK BX	F.71
1928530000	BVL 7.62HP/05/90SFI 3.5SN BK BX	F.71
1928540000	BVL 7.62HP/06/90SFI 3.5SN BK BX	F.71
1928550000	BVL 7.62HP/07/90SFI 3.5SN BK BX	F.71
1928610000	BVL 7.62HP/02/180 3.5SN BK BX	F.72
1928620000	BVL 7.62HP/03/180 3.5SN BK BX	F.72
1928630000	BVL 7.62HP/04/180 3.5SN BK BX	F.72
1928650000	BVL 7.62HP/05/180 3.5SN BK BX	F.72
1928660000	BVL 7.62HP/06/180 3.5SN BK BX	F.72
1928670000	BVL 7.62HP/07/180 3.5SN BK BX	F.72
1928730000	BVL 7.62HP/02/180FI 3.5SN BK BX	F.73
1928740000	BVL 7.62HP/03/180FI 3.5SN BK BX	F.73
1928750000	BVL 7.62HP/04/180FI 3.5SN BK BX	F.73
1928760000	BVL 7.62HP/05/180FI 3.5SN BK BX	F.73
1928770000	BVL 7.62HP/06/180FI 3.5SN BK BX	F.73
1928780000	BVL 7.62HP/07/180FI 3.5SN BK BX	F.73
1928840000	BVL 7.62HP/02/180SFI 3.5SN BK BX	F.73
1928850000	BVL 7.62HP/03/180SFI 3.5SN BK BX	F.73
1928860000	BVL 7.62HP/04/180SFI 3.5SN BK BX	F.73
1928870000	BVL 7.62HP/05/180SFI 3.5SN BK BX	F.73
1928900000	BVL 7.62HP/06/180SFI 3.5SN BK BX	F.73
1928910000	BVL 7.62HP/07/180SFI 3.5SN BK BX	F.73
1929300000	BVL 7.62HP/02/270 3.5SN BK BX	F.74
1929310000	BVL 7.62HP/03/270 3.5SN BK BX	F.74
1929320000	BVL 7.62HP/04/270 3.5SN BK BX	F.74
1929330000	BVL 7.62HP/05/270 3.5SN BK BX	F.74
1929340000	BVL 7.62HP/06/270 3.5SN BK BX	F.74
1929350000	BVL 7.62HP/07/270 3.5SN BK BX	F.74
1929410000	BVL 7.62HP/02/270FI 3.5SN BK BX	F.75
1929420000	BVL 7.62HP/03/270FI 3.5SN BK BX	F.75
1929430000	BVL 7.62HP/04/270FI 3.5SN BK BX	F.75
1929440000	BVL 7.62HP/05/270FI 3.5SN BK BX	F.75
1929450000	BVL 7.62HP/06/270FI 3.5SN BK BX	F.75
1929460000	BVL 7.62HP/07/270FI 3.5SN BK BX	F.75
1929520000	BVL 7.62HP/02/270SFI 3.5SN BK BX	F.75
1929530000	BVL 7.62HP/03/270SFI 3.5SN BK BX	F.75
1929540000	BVL 7.62HP/04/270SFI 3.5SN BK BX	F.75
1929550000	BVL 7.62HP/05/270SFI 3.5SN BK BX	F.75
1929560000	BVL 7.62HP/06/270SFI 3.5SN BK BX	F.75
1929570000	BVL 7.62HP/07/270SFI 3.5SN BK BX	F.75
1929740000	BVZ 7.62HP/02/180SFC SN BK BX	F.59
1929750000	BVZ 7.62HP/03/180SFC SN BK BX	F.59
1929760000	BVZ 7.62HP/04/180SFC SN BK BX	F.59
1929770000	BVZ 7.62HP/05/180SFC SN BK BX	F.59
1929780000	BVZ 7.62HP/06/180SFC SN BK BX	F.59
1929790000	BVZ 7.62HP/07/180SFC SN BK BX	F.59
1929850000	BVZ 7.62HP/03/180SH150 SN BK BX	F.60
1929860000	BVZ 7.62HP/04/180SH150 SN BK BX	F.60
1929870000	BVZ 7.62HP/05/180SH150 SN BK BX	F.60
1929880000	BVZ 7.62HP/06/180SH150 SN BK BX	F.60
1929890000	BVZ 7.62HP/03/180SH150C SN BK BX	F.62
1929900000	BVZ 7.62HP/04/180SH150C SN BK BX	F.62
1929910000	BVZ 7.62HP/05/180SH150C SN BK BX	F.62
1929920000	BVZ 7.62HP/06/180SH150C SN BK BX	F.62
1929930000	BVZ 7.62HP/07/180 SN BK BX	F.58
1929940000	BVZ 7.62HP/03/180 SN BK BX	F.58
1929950000	BVZ 7.62HP/04/180 SN BK BX	F.58
1929960000	BVZ 7.62HP/05/180 SN BK BX	F.58
1929970000	BVZ 7.62HP/06/180 SN BK BX	F.58
1929980000	BVZ 7.62HP/07/180 SN BK BX	F.58

1930000000

1930050000	BVZ 7.62HP/02/180F SN BK BX	F.59
1930060000	BVZ 7.62HP/03/180F SN BK BX	F.59
1930070000	BVZ 7.62HP/04/180F SN BK BX	F.59
1930080000	BVZ 7.62HP/05/180F SN BK BX	F.59
1930090000	BVZ 7.62HP/06/180F SN BK BX	F.59
1930100000	BVZ 7.62HP/07/180F SN BK BX	F.59
1930160000	BVZ 7.62HP/02/180SF SN BK BX	F.59
1930170000	BVZ 7.62HP/03/180SF SN BK BX	F.59
1930180000	BVZ 7.62HP/04/180SF SN BK BX	F.59
1930190000	BVZ 7.62HP/05/180SF SN BK BX	F.59
1930200000	BVZ 7.62HP/06/180SF SN BK BX	F.59
1930210000	BVZ 7.62HP/07/180SF SN BK BX	F.59
1930270000	SV 7.62HP/02/90G 3.5SN BK BX	F.28
1930280000	SV 7.62HP/03/90G 3.5SN BK BX	F.28
1930290000	SV 7.62HP/04/90G 3.5SN BK BX	F.28
1930300000	SV 7.62HP/05/90G 3.5SN BK BX	F.28
1930310000	SV 7.62HP/06/90G 3.5SN BK BX	F.28
1930320000	SV 7.62HP/07/90G 3.5SN BK BX	F.28
1930380000	SV 7.62HP/02/90F 3.5SN BK BX	F.29
1930390000	SV 7.62HP/03/90F 3.5SN BK BX	F.29
1930400000	SV 7.62HP/04/90F 3.5SN BK BX	F.29
1930410000	SV 7.62HP/05/90F 3.5SN BK BX	F.29
1930420000	SV 7.62HP/06/90F 3.5SN BK BX	F.29
1930430000	SV 7.62HP/07/90F 3.5SN BK BX	F.29
1930490000	SV 7.62HP/02/90SF 3.5SN BK BX	F.29
1930500000	SV 7.62HP/03/90SF 3.5SN BK BX	F.29
1930510000	SV 7.62HP/04/90SF 3.5SN BK BX	F.29
1930520000	SV 7.62HP/05/90SF 3.5SN BK BX	F.29
1930530000	SV 7.62HP/06/90SF 3.5SN BK BX	F.29
1930540000	SV 7.62HP/07/90SF 3.5SN BK BX	F.29
1930600000	SV 7.62HP/02/180G 3.5SN BK BX	F.30
1930610000	SV 7.62HP/03/180G 3.5SN BK BX	F.30
1930620000	SV 7.62HP/04/180G 3.5SN BK BX	F.30
1930630000	SV 7.62HP/05/180G 3.5SN BK BX	F.30

Order No.	Type	Page
1930640000	SV 7.62HP/06/180G 3.5SN BK BX	F.30
1930650000	SV 7.62HP/07/180G 3.5SN BK BX	F.30
1930710000	SV 7.62HP/02/180F 3.5SN BK BX	F.31
1930720000	SV 7.62HP/03/180F 3.5SN BK BX	F.31
1930730000	SV 7.62HP/04/180F 3.5SN BK BX	F.31
1930740000	SV 7.62HP/05/180F 3.5SN BK BX	F.31
1930750000	SV 7.62HP/06/180F 3.5SN BK BX	F.31
1930760000	SV 7.62HP/07/180F 3.5SN BK BX	F.31
1930820000	SV 7.62HP/02/180SF 3.5SN BK BX	F.31
1930830000	SV 7.62HP/03/180SF 3.5SN BK BX	F.31
1930840000	SV 7.62HP/04/180SF 3.5SN BK BX	F.31
1930850000	SV 7.62HP/05/180SF 3.5SN BK BX	F.31
1930860000	SV 7.62HP/06/180SF 3.5SN BK BX	F.31
1930870000	SV 7.62HP/07/180SF 3.5SN BK BX	F.31
1931260000	SV 7.62HP/02/270G 3.5SN BK BX	F.34
1931270000	SV 7.62HP/03/270G 3.5SN BK BX	F.34
1931280000	SV 7.62HP/04/270G 3.5SN BK BX	F.34
1931290000	SV 7.62HP/05/270G 3.5SN BK BX	F.34
1931300000	SV 7.62HP/06/270G 3.5SN BK BX	F.34
1931310000	SV 7.62HP/07/270G 3.5SN BK BX	F.34
1931370000	SV 7.62HP/02/270F 3.5SN BK BX	F.35
1931380000	SV 7.62HP/03/270F 3.5SN BK BX	F.35
1931390000	SV 7.62HP/04/270F 3.5SN BK BX	F.35
1931400000	SV 7.62HP/05/270F 3.5SN BK BX	F.35
1931410000	SV 7.62HP/06/270F 3.5SN BK BX	F.35
1931420000	SV 7.62HP/07/270F 3.5SN BK BX	F.35
1931480000	SV 7.62HP/02/270SF 3.5SN BK BX	F.35
1931490000	SV 7.62HP/03/270SF 3.5SN BK BX	F.35
1931500000	SV 7.62HP/04/270SF 3.5SN BK BX	F.35
1931510000	SV 7.62HP/05/270SF 3.5SN BK BX	F.35
1931520000	SV 7.62HP/06/270SF 3.5SN BK BX	F.35
1931530000	SV 7.62HP/07/270SF 3.5SN BK BX	F.35
1931620000	SVZ 7.62HP/02/180G SN BK BX	F.38
1931630000	SVZ 7.62HP/03/180G SN BK BX	F.38
1931640000	SVZ 7.62HP/04/180G SN BK BX	F.38
1931660000	SVZ 7.62HP/05/180G SN BK BX	F.38
1931670000	SVZ 7.62HP/06/180G SN BK BX	F.38
1931680000	SVZ 7.62HP/07/180G SN BK BX	F.38
1931740000	SVZ 7.62HP/02/180F SN BK BX	F.39
1931760000	SVZ 7.62HP/03/180F SN BK BX	F.39
1931820000	SVZ 7.62HP/04/180F SN BK BX	F.39
1931840000	SVZ 7.62HP/05/180F SN BK BX	F.39
1931850000	SVZ 7.62HP/06/180F SN BK BX	F.39
1931860000	SVZ 7.62HP/07/180F SN BK BX	F.39
1931960000	SVZ 7.62HP/02/180SF SN BK BX	F.39
1931970000	SVZ 7.62HP/03/180SF SN BK BX	F.39
1931980000	SVZ 7.62HP/04/180SF SN BK BX	F.39
1931990000	SVZ 7.62HP/05/180SF SN BK BX	F.39
1932000000	SVZ 7.62HP/06/180SF SN BK BX	F.39
1932010000	SVZ 7.62HP/07/180SF SN BK BX	F.39
1932070000	SVZ 7.62HP/02/180FI SN BK BX	F.42
1932080000	SVZ 7.62HP/03/180FI SN BK BX	F.42
1932090000	SVZ 7.62HP/04/180FI SN BK BX	F.42
1932100000	SVZ 7.62HP/05/180FI SN BK BX	F.42
1932110000	SVZ 7.62HP/06/180FI SN BK BX	F.42
1932120000	SVZ 7.62HP/07/180FI SN BK BX	F.42
1932180000	SVZ 7.62HP/02/180SFI SN BK BX	F.43
1932190000	SVZ 7.62HP/03/180SFI SN BK BX	F.43
1932200000	SVZ 7.62HP/04/180SFI SN BK BX	F.43
1932210000	SVZ 7.62HP/05/180SFI SN BK BX	F.43
1932220000	SVZ 7.62HP/06/180SFI SN BK BX	F.43
1932230000	SVZ 7.62HP/07/180SFI SN BK BX	F.43
1932330000	SVZ 7.62HP/03/180SH150I SN BK BX	F.48
1932340000	SVZ 7.62HP/04/180SH150I SN BK BX	F.48
1932350000	SVZ 7.62HP/05/180SH150I SN BK BX	F.48
1932360000	SVZ 7.62HP/06/180SH150I SN BK BX	F.48
1932460000	SVZ 7.62HP/03/180SH180 SN BK BX	F.44
1932470000	SVZ 7.62HP/04/180SH180 SN BK BX	F.44
1932480000	SVZ 7.62HP/05/180SH180 SN BK BX	F.44
1932490000	SVZ 7.62HP/06/180SH180 SN BK BX	F.44
1932500000	SVZ 7.62HP/03/180SH180I SN BK BX	F.49
1932510000	SVZ 7.62HP/04/180SH180I SN BK BX	F.49
1932520000	SVZ 7.62HP/05/180SH180I SN BK BX	F.49
1932530000	SVZ 7.62HP/06/180SH180I SN BK BX	F.49
1932580000	SVZ 7.62HP/03/180SH210I SN BK BX	F.49
1932590000	SVZ 7.62HP/04/180SH210I SN BK BX	F.49
1932600000	SVZ 7.62HP/05/180SH210I SN BK BX	F.49
1932610000	SVZ 7.62HP/06/180SH210I SN BK BX	F.49
1933340000	BVZ 7.62HP/03/180SH180 SN BK BX	F.61
1933350000	BVZ 7.62HP/04/180SH180 SN BK BX	F.61
1933360000	BVZ 7.62HP/05/180SH180 SN BK BX	F.61
1933370000	BVZ 7.62HP/06/180SH180 SN BK BX	F.61
1933380000	BVZ 7.62HP/03/180SH180C SN BK BX	F.63
1933390000	BVZ 7.62HP/04/180SH180C SN BK BX	F.63
1933400000	BVZ 7.62HP/05/180SH180C SN BK BX	F.63
1933410000	BVZ 7.62HP/06/180SH180C SN BK BX	F.63
1933430000	BVZ 7.62HP/03/180SH210 SN BK BX	F.61
1933440000	BVZ 7.62HP/04/180SH210 SN BK BX	F.61
1933450000	BVZ 7.62HP/05/180SH210 SN BK BX	F.61
1933460000	BVZ 7.62HP/06/180SH210 SN BK BX	F.61
1933470000	BVZ 7.62HP/03/180SH210C SN BK BX	F.63
1933480000	BVZ 7.62HP/04/180SH210C SN BK BX	F.63
1933490000	BVZ 7.62HP/05/180SH210C SN BK BX	F.63
1933500000	BVZ 7.62HP/06/180SH210C SN BK BX	F.63
1933550000	BLZ DN 5.08/05/180F AU GY PRT	C.231
1933560000	BLZ DN 5.08/05/180 AU GY SO	C.230
1933570000	BLZ DN 5.08/05/180F AU GY SO	C.231
1934050000	WGKV 4	G.8
1934060000	WGKV 10	G.9

Order No.	Type	Page
1934070000	WGKV 25	G.12
1934140000	LU 10.16/02/90 4.5SN BK BX	E.6
1934250000	LL 5.08/02/90 3.2SN OR BX	B.39
1934260000	LL 5.08/03/90 3.2SN OR BX	B.39
1934270000	LL 5.00/02/90 3.2SN OR BX	B.38
1934280000	LL 5.00/03/90 3.2SN OR BX	B.38
1934310000	LL2N 5.00/04/90 3.2SN OR BX	B.41
1934340000	LL3R 5.08/06/90 3.2SN OR BX	B.43
1934360000	LL3R 5.00/06/90 3.2SN OR BX	B.41
1936430000	DP VWGK 4	G.15
1936440000	DP WGK 10	G.9
1936450000	DP WGK 4	G.9
1936470000	DP WGKV 4	G.8
1936480000	VWGK 4 GN/YE	G.15
1936490000	VWGK 4	G.15
1936500000	WGK 10 GN/YE	G.9
1936510000	WGK 10	G.9
1936520000	WGK 10/Z gn/ye	G.9
1936530000	WGK 10/Z	G.9
1936540000	WGK 4 GN/YE	G.8
1936550000	WGK 4	G.8
1936560000	WGK 4/Z gn/ye	G.8
1936570000	WGK 4/Z	G.8
1936580000	WGKV 10 gn/ye	G.9
1936590000	WGKV 10/Z gn/ye	G.9
1936600000	WGKV 10/Z	G.9
1936610000	WGKV 4 gn/ye	G.8
1936620000	WGKV 4/Z gn/ye	G.8
1936630000	WGKV 4/Z	G.8
1936700000	DP WGK 16	G.10
1936710000	DP WGK 25	G.11
1936720000	WGKV 25 gn/ye	G.12
1936740000	WGKV 25/Z gn/ye	G.12
1936750000	WGKV 25/Z	G.12
1936760000	WGK 16 gn/ye	G.10
19367		

Order No.	Type	Page
1979750000	SC 3.81 FLA 2.3/14.25	D.9
1979790000	BLF 5.00HC/02/90LR SN BK BX	C.161
1979800000	BLF 5.00HC/03/90LR SN BK BX	C.161
1979810000	BLF 5.00HC/04/90LR SN BK BX	C.161
1979820000	BLF 5.00HC/05/90LR SN BK BX	C.161
1979830000	BLF 5.00HC/06/90LR SN BK BX	C.161
1979840000	BLF 5.00HC/07/90LR SN BK BX	C.161
1979850000	BLF 5.00HC/08/90LR SN BK BX	C.161
1979860000	BLF 5.00HC/09/90LR SN BK BX	C.161
1979870000	BLF 5.00HC/10/90LR SN BK BX	C.161
1979880000	BLF 5.00HC/11/90LR SN BK BX	C.161
1979890000	BLF 5.00HC/12/90LR SN BK BX	C.161
1979900000	BLF 5.00HC/13/90LR SN BK BX	C.161
1979910000	BLF 5.00HC/14/90LR SN BK BX	C.161
1979920000	BLF 5.00HC/15/90LR SN BK BX	C.161
1979930000	BLF 5.00HC/16/90LR SN BK BX	C.161
1979940000	BLF 5.00HC/17/90LR SN BK BX	C.161
1979950000	BLF 5.00HC/18/90LR SN BK BX	C.161
1979960000	BLF 5.00HC/19/90LR SN BK BX	C.161
1979970000	BLF 5.00HC/20/90LR SN BK BX	C.161

1980000000

1980170000	BLF 5.00HC/02/90 SN DR BX	C.160
1980180000	BLF 5.00HC/03/90 SN DR BX	C.160
1980190000	BLF 5.00HC/04/90 SN DR BX	C.160
1980200000	BLF 5.00HC/05/90 SN DR BX	C.160
1980210000	BLF 5.00HC/06/90 SN DR BX	C.160
1980220000	BLF 5.00HC/07/90 SN DR BX	C.160
1980230000	BLF 5.00HC/08/90 SN DR BX	C.160
1980240000	BLF 5.00HC/09/90 SN DR BX	C.160
1980250000	BLF 5.00HC/10/90 SN DR BX	C.160
1980260000	BLF 5.00HC/11/90 SN DR BX	C.160
1980270000	BLF 5.00HC/12/90 SN DR BX	C.160
1980280000	BLF 5.00HC/13/90 SN DR BX	C.160
1980290000	BLF 5.00HC/14/90 SN DR BX	C.160
1980300000	BLF 5.00HC/15/90 SN DR BX	C.160
1980310000	BLF 5.00HC/16/90 SN DR BX	C.160
1980320000	BLF 5.00HC/17/90 SN DR BX	C.160
1980330000	BLF 5.00HC/18/90 SN DR BX	C.160
1980340000	BLF 5.00HC/19/90 SN DR BX	C.160
1980360000	BLF 5.00HC/20/90 SN DR BX	C.160
1980640000	BLF 5.00HC/02/90F SN DR BX	C.161
1980650000	BLF 5.00HC/03/90F SN DR BX	C.161
1980660000	BLF 5.00HC/04/90F SN DR BX	C.161
1980670000	BLF 5.00HC/05/90F SN DR BX	C.161
1980680000	BLF 5.00HC/06/90F SN DR BX	C.161
1980690000	BLF 5.00HC/07/90F SN DR BX	C.161
1980700000	BLF 5.00HC/08/90F SN DR BX	C.161
1980710000	BLF 5.00HC/09/90F SN DR BX	C.161
1980720000	BLF 5.00HC/10/90F SN DR BX	C.161
1980730000	BLF 5.00HC/11/90F SN DR BX	C.161
1980740000	BLF 5.00HC/12/90F SN DR BX	C.161
1980750000	BLF 5.00HC/13/90F SN DR BX	C.161
1980760000	BLF 5.00HC/14/90F SN DR BX	C.161
1980780000	BLF 5.00HC/15/90F SN DR BX	C.161
1980790000	BLF 5.00HC/16/90F SN DR BX	C.161
1980800000	BLF 5.00HC/17/90F SN DR BX	C.161
1980810000	BLF 5.00HC/18/90F SN DR BX	C.161
1980820000	BLF 5.00HC/19/90F SN DR BX	C.161
1980840000	BLF 5.00HC/20/90F SN DR BX	C.161
1980870000	BLF 5.00HC/02/90LR SN DR BX	C.161
1980880000	BLF 5.00HC/03/90LR SN DR BX	C.161
1980890000	BLF 5.00HC/04/90LR SN DR BX	C.161
1980900000	BLF 5.00HC/05/90LR SN DR BX	C.161
1980910000	BLF 5.00HC/06/90LR SN DR BX	C.161
1980920000	BLF 5.00HC/07/90LR SN DR BX	C.161
1980930000	BLF 5.00HC/08/90LR SN DR BX	C.161
1980940000	BLF 5.00HC/09/90LR SN DR BX	C.161
1980950000	BLF 5.00HC/10/90LR SN DR BX	C.161
1980960000	BLF 5.00HC/11/90LR SN DR BX	C.161
1980970000	BLF 5.00HC/12/90LR SN DR BX	C.161
1980980000	BLF 5.00HC/13/90LR SN DR BX	C.161
1980990000	BLF 5.00HC/14/90LR SN DR BX	C.161
1981000000	BLF 5.00HC/15/90LR SN DR BX	C.161
1981010000	BLF 5.00HC/16/90LR SN DR BX	C.161
1981020000	BLF 5.00HC/17/90LR SN DR BX	C.161
1981030000	BLF 5.00HC/18/90LR SN DR BX	C.161
1981040000	BLF 5.00HC/19/90LR SN DR BX	C.161
1981050000	BLF 5.00HC/20/90LR SN DR BX	C.161
1981880000	WGK 10 VP	G.10
1981890000	WGK 4 VP	G.9
1981930000	BLF 5.08HC/02/270 SN BK BX	C.244
1981940000	BLF 5.08HC/03/270 SN BK BX	C.244
1981950000	BLF 5.08HC/04/270 SN BK BX	C.244
1981960000	BLF 5.08HC/05/270 SN BK BX	C.244
1981970000	BLF 5.08HC/06/270 SN BK BX	C.244
1981980000	BLF 5.08HC/07/270 SN BK BX	C.244
1981990000	BLF 5.08HC/08/270 SN BK BX	C.244
1982000000	BLF 5.08HC/09/270 SN BK BX	C.244
1982010000	BLF 5.08HC/10/270 SN BK BX	C.244
1982020000	BLF 5.08HC/11/270 SN BK BX	C.244
1982030000	BLF 5.08HC/12/270 SN BK BX	C.244
1982040000	BLF 5.08HC/13/270 SN BK BX	C.244
1982050000	BLF 5.08HC/14/270 SN BK BX	C.244
1982060000	BLF 5.08HC/15/270 SN BK BX	C.244
1982070000	BLF 5.08HC/16/270 SN BK BX	C.244
1982080000	BLF 5.08HC/17/270 SN BK BX	C.244
1982090000	BLF 5.08HC/18/270 SN BK BX	C.244

Order No.	Type	Page
1982100000	BLF 5.08HC/19/270 SN BK BX	C.244
1982110000	BLF 5.08HC/20/270 SN BK BX	C.244
1982120000	BLF 5.08HC/02/270F SN BK BX	C.245
1982130000	BLF 5.08HC/03/270F SN BK BX	C.245
1982140000	BLF 5.08HC/04/270F SN BK BX	C.245
1982150000	BLF 5.08HC/05/270F SN BK BX	C.245
1982160000	BLF 5.08HC/06/270F SN BK BX	C.245
1982170000	BLF 5.08HC/07/270F SN BK BX	C.245
1982180000	BLF 5.08HC/08/270F SN BK BX	C.245
1982190000	BLF 5.08HC/09/270F SN BK BX	C.245
1982200000	BLF 5.08HC/10/270F SN BK BX	C.245
1982210000	BLF 5.08HC/11/270F SN BK BX	C.245
1982220000	BLF 5.08HC/12/270F SN BK BX	C.245
1982230000	BLF 5.08HC/13/270F SN BK BX	C.245
1982240000	BLF 5.08HC/14/270F SN BK BX	C.245
1982250000	BLF 5.08HC/15/270F SN BK BX	C.245
1982260000	BLF 5.08HC/16/270F SN BK BX	C.245
1982270000	BLF 5.08HC/17/270F SN BK BX	C.245
1982280000	BLF 5.08HC/18/270F SN BK BX	C.245
1982290000	BLF 5.08HC/19/270F SN BK BX	C.245
1982300000	BLF 5.08HC/20/270F SN BK BX	C.245
1982310000	BLF 5.08HC/02/270LR SN BK BX	C.245
1982320000	BLF 5.08HC/03/270LR SN BK BX	C.245
1982330000	BLF 5.08HC/04/270LR SN BK BX	C.245
1982340000	BLF 5.08HC/05/270LR SN BK BX	C.245
1982350000	BLF 5.08HC/06/270LR SN BK BX	C.245
1982360000	BLF 5.08HC/07/270LR SN BK BX	C.245
1982370000	BLF 5.08HC/08/270LR SN BK BX	C.245
1982380000	BLF 5.08HC/09/270LR SN BK BX	C.245
1982390000	BLF 5.08HC/10/270LR SN BK BX	C.245
1982400000	BLF 5.08HC/11/270LR SN BK BX	C.245
1982410000	BLF 5.08HC/12/270LR SN BK BX	C.245
1982420000	BLF 5.08HC/13/270LR SN BK BX	C.245
1982430000	BLF 5.08HC/14/270LR SN BK BX	C.245
1982440000	BLF 5.08HC/15/270LR SN BK BX	C.245
1982450000	BLF 5.08HC/16/270LR SN BK BX	C.245
1982460000	BLF 5.08HC/17/270LR SN BK BX	C.245
1982470000	BLF 5.08HC/18/270LR SN BK BX	C.245
1982480000	BLF 5.08HC/19/270LR SN BK BX	C.245
1982490000	BLF 5.08HC/20/270LR SN BK BX	C.245
1982700000	BLF 5.08HC/02/270 SN DR BX	C.244
1982710000	BLF 5.08HC/03/270 SN DR BX	C.244
1982720000	BLF 5.08HC/04/270 SN DR BX	C.244
1982730000	BLF 5.08HC/05/270 SN DR BX	C.244
1982740000	BLF 5.08HC/06/270 SN DR BX	C.244
1982750000	BLF 5.08HC/07/270 SN DR BX	C.244
1982760000	BLF 5.08HC/08/270 SN DR BX	C.244
1982770000	BLF 5.08HC/09/270 SN DR BX	C.244
1982780000	BLF 5.08HC/10/270 SN DR BX	C.244
1982790000	BLF 5.08HC/11/270 SN DR BX	C.244
1982800000	BLF 5.08HC/12/270 SN DR BX	C.244
1982810000	BLF 5.08HC/13/270 SN DR BX	C.244
1982820000	BLF 5.08HC/14/270 SN DR BX	C.244
1982830000	BLF 5.08HC/15/270 SN DR BX	C.244
1982840000	BLF 5.08HC/16/270 SN DR BX	C.244
1982850000	BLF 5.08HC/17/270 SN DR BX	C.244
1982860000	BLF 5.08HC/18/270 SN DR BX	C.244
1982870000	BLF 5.08HC/19/270 SN DR BX	C.244
1982880000	BLF 5.08HC/20/270 SN DR BX	C.244
1982890000	BLF 5.08HC/02/270F SN DR BX	C.245
1982900000	BLF 5.08HC/03/270F SN DR BX	C.245
1982910000	BLF 5.08HC/04/270F SN DR BX	C.245
1982920000	BLF 5.08HC/05/270F SN DR BX	C.245
1982930000	BLF 5.08HC/06/270F SN DR BX	C.245
1982940000	BLF 5.08HC/07/270F SN DR BX	C.245
1982950000	BLF 5.08HC/08/270F SN DR BX	C.245
1982960000	BLF 5.08HC/09/270F SN DR BX	C.245
1982970000	BLF 5.08HC/10/270F SN DR BX	C.245
1982980000	BLF 5.08HC/11/270F SN DR BX	C.245
1982990000	BLF 5.08HC/12/270F SN DR BX	C.245
1983000000	BLF 5.08HC/13/270F SN DR BX	C.245
1983010000	BLF 5.08HC/14/270F SN DR BX	C.245
1983020000	BLF 5.08HC/15/270F SN DR BX	C.245
1983030000	BLF 5.08HC/16/270F SN DR BX	C.245
1983040000	BLF 5.08HC/17/270F SN DR BX	C.245
1983050000	BLF 5.08HC/18/270F SN DR BX	C.245
1983060000	BLF 5.08HC/19/270F SN DR BX	C.245
1983070000	BLF 5.08HC/20/270F SN DR BX	C.245
1983080000	BLF 5.08HC/02/270LR SN DR BX	C.245
1983090000	BLF 5.08HC/03/270LR SN DR BX	C.245
1983100000	BLF 5.08HC/04/270LR SN DR BX	C.245
1983110000	BLF 5.08HC/05/270LR SN DR BX	C.245
1983120000	BLF 5.08HC/06/270LR SN DR BX	C.245
1983130000	BLF 5.08HC/07/270LR SN DR BX	C.245
1983140000	BLF 5.08HC/08/270LR SN DR BX	C.245
1983150000	BLF 5.08HC/09/270LR SN DR BX	C.245
1983160000	BLF 5.08HC/10/270LR SN DR BX	C.245
1983170000	BLF 5.08HC/11/270LR SN DR BX	C.245
1983180000	BLF 5.08HC/12/270LR SN DR BX	C.245
1983190000	BLF 5.08HC/13/270LR SN DR BX	C.245
1983200000	BLF 5.08HC/14/270LR SN DR BX	C.245
1983210000	BLF 5.08HC/15/270LR SN DR BX	C.245
1983220000	BLF 5.08HC/16/270LR SN DR BX	C.245
1983230000	BLF 5.08HC/17/270LR SN DR BX	C.245
1983240000	BLF 5.08HC/18/270LR SN DR BX	C.245
1983250000	BLF 5.08HC/19/270LR SN DR BX	C.245
1983260000	BLF 5.08HC/20/270LR SN DR BX	C.245

Order No.	Type	Page
2220000000		
2224040000	KOPL MCZ 1.5	I.39
2224220000	GH MC21.5	I.39
2224240000	RA MCZ1.5	I.39
2224380000	SMSE LN FE MCZ 1.5	I.39
2224390000	SMSE KU FE MCZ 1.5	I.39

2270000000

2277000000	SMSE2 ZF MSD	I.38
2277700000	EBGH MSA ZB	I.38
2277710000	EBGH MSA ZF	I.38
2279280000	GHDE MSA ZB FR 12	I.38
2279300000	GHDE MSA ZF	I.38
2279350000	SMSE FE MSA	I.38

2310000000

2312290000	GH MCZUE1.5/UE	I.39
------------	----------------	------

2410000000

2418580000	LHZ-SMT L 1.5SN BK RL	I.17
2418590000	LHZ-SMT R 1.5SN BK RL	I.17
2418600000	CH20M6 BP 4P-4P BK	I.16
2418610000	CH20M6 BC 4P-4P BK	I.16
2418620000	CH20M6 C BK	I.17
2418630000	CH20M22 B BK/BK	I.22
2418640000	CH20M22 F BK	I.23
2418650000	CH20M22 5 PPSK BK	I.22
2418670000	CH20M22 C BK	I.23

4010000000

4010870000	PF RS 100 GR 2000MM A.1	I.48
4011200000	LKSC M2.9x13VZ	I.44
4019420000	PTSC KB40X14	I.48

4020000000

4027750000	PF RS 45 GR 2000MM	I.44
------------	--------------------	------

4050000000

4051810000	PF RS 90 GR 2000MM	I.47
4053240000	PF RS 90 OR 2000MM	I.47

4060000000

4060540000	SMSE 1 MSD ZB	I.38
------------	---------------	------

4140000000

Order No.	Type	Page
-----------	------	------

8380000000

8389030000	AP MCZ1.5	1.39
------------	-----------	------

8850000000

8857560000	MCZ 5	1.39
------------	-------	------

9000000000

9004530000	DW RSV 1.6	D.21
9004590000	H0,5/14S W	C.158
9005990000	PZ 1.5	C.12
9008320000	SDS 0.5X3.0X80	D.22
9008330000	SDS 0.6X3.5X100	J.3
9008340000	SDS 0.8X4.0X100	D.22
9008350000	SDS 1.0X5.5X150	D.22
9008370000	SDIS 0.4X2.5X75	D.22
9008380000	SDIS 0.5X3.0X100	D.22
9008390000	SDIS 0.6X3.5X100	D.22
9008400000	SDIS 0.8X4.0X100	D.22
9008410000	SDIS 1.0X5.5X125	D.22
9008420000	SDIS 1.2X6.5X150	D.22
9008430000	SDIS 1.6X8.0X175	D.22
9008470000	SDK PH0	D.22
9008480000	SDK PH1	J.3
9008490000	SDK PH2	D.22
9008500000	SDK PH3	D.22
9008530000	SDK PZ1	J.3
9008540000	SDK PZ2	D.22
9008550000	SDK PZ3	D.22
9008890000	SDIK PZ2	E.10
9008910000	SDIS 1.0X4.5X125	D.22
9009010000	SDS 1.2X6.5X150	D.22
9009020000	SDS 0.8X4.0X125	D.22
9009030000	SDS 0.4X2.5X75	D.22

9010000000

9011460000	PZ 6/5	F.68
9013090000	HTF 28	D.20
9013400000	HTF 63	D.20
9013550000	HTF RSV 12	D.20
9013560000	HTF RSV 16 WI	D.20
9014140000	HTF DFF	D.20
9018560000	H1,0/14S R	C.158

9020000000

9025240000	H1,5/14S SW	C.158
------------	-------------	-------

9990000000

9994130000	LM 5.08/04/90 3.5SN OR BX	B.18
9994140000	LM 5.08/05/90 3.5SN OR BX	B.18
9994150000	LM 5.08/06/90 3.5SN OR BX	B.18
9994160000	LM 5.08/07/90 3.5SN OR BX	B.18
9994170000	LM 5.08/08/90 3.5SN OR BX	B.18
9994180000	LM 5.08/09/90 3.5SN OR BX	B.18
9994190000	LM 5.08/10/90 3.5SN OR BX	B.18
9994200000	LM 5.08/11/90 3.5SN OR BX	B.18
9994210000	LM 5.08/12/90 3.5SN OR BX	B.18
9994220000	LM 5.08/13/90 3.5SN OR BX	B.18
9994230000	LM 5.08/14/90 3.5SN OR BX	B.18
9994240000	LM 5.08/15/90 3.5SN OR BX	B.18
9994250000	LM 5.08/16/90 3.5SN OR BX	B.18
9994260000	LM 5.08/17/90 3.5SN OR BX	B.18
9994270000	LM 5.08/18/90 3.5SN OR BX	B.18
9994280000	LM 5.08/19/90 3.5SN OR BX	B.18
9994290000	LM 5.08/20/90 3.5SN OR BX	B.18
9994300000	LM 5.08/21/90 3.5SN OR BX	B.18
9994310000	LM 5.08/22/90 3.5SN OR BX	B.18
9994320000	LM 5.08/23/90 3.5SN OR BX	B.18
9994330000	LM 5.08/24/90 3.5SN OR BX	B.18
9994550000	LM 5.08/04/135 3.5SN OR BX	B.19
9994560000	LM 5.08/05/135 3.5SN OR BX	B.19
9994570000	LM 5.08/06/135 3.5SN OR BX	B.19
9994580000	LM 5.08/07/135 3.5SN OR BX	B.19
9994590000	LM 5.08/08/135 3.5SN OR BX	B.19
9994600000	LM 5.08/09/135 3.5SN OR BX	B.19
9994610000	LM 5.08/10/135 3.5SN OR BX	B.19
9994620000	LM 5.08/11/135 3.5SN OR BX	B.19
9994630000	LM 5.08/12/135 3.5SN OR BX	B.19
9994640000	LM 5.08/13/135 3.5SN OR BX	B.19
9994650000	LM 5.08/14/135 3.5SN OR BX	B.19
9994660000	LM 5.08/15/135 3.5SN OR BX	B.19
9994670000	LM 5.08/16/135 3.5SN OR BX	B.19
9994680000	LM 5.08/17/135 3.5SN OR BX	B.19
9994690000	LM 5.08/18/135 3.5SN OR BX	B.19
9994700000	LM 5.08/19/135 3.5SN OR BX	B.19
9994710000	LM 5.08/20/135 3.5SN OR BX	B.19
9994720000	LM 5.08/21/135 3.5SN OR BX	B.19
9994730000	LM 5.08/22/135 3.5SN OR BX	B.19
9994740000	LM 5.08/23/135 3.5SN OR BX	B.19
9994750000	LM 5.08/24/135 3.5SN OR BX	B.19
9994970000	LM 5.08/04/180 3.5SN OR BX	B.19
9994980000	LM 5.08/05/180 3.5SN OR BX	B.19
9994990000	LM 5.08/06/180 3.5SN OR BX	B.19
9995000000	LM 5.08/07/180 3.5SN OR BX	B.19

Order No.	Type	Page
-----------	------	------

9995010000	LM 5.08/08/180 3.5SN OR BX	B.19
9995020000	LM 5.08/09/180 3.5SN OR BX	B.19
9995030000	LM 5.08/10/180 3.5SN OR BX	B.19
9995040000	LM 5.08/11/180 3.5SN OR BX	B.19
9995050000	LM 5.08/12/180 3.5SN OR BX	B.19
9995060000	LM 5.08/13/180 3.5SN OR BX	B.19
9995070000	LM 5.08/14/180 3.5SN OR BX	B.19
9995080000	LM 5.08/15/180 3.5SN OR BX	B.19
9995090000	LM 5.08/16/180 3.5SN OR BX	B.19
9995100000	LM 5.08/17/180 3.5SN OR BX	B.19
9995110000	LM 5.08/18/180 3.5SN OR BX	B.19
9995120000	LM 5.08/19/180 3.5SN OR BX	B.19
9995130000	LM 5.08/20/180 3.5SN OR BX	B.19
9995140000	LM 5.08/21/180 3.5SN OR BX	B.19
9995150000	LM 5.08/22/180 3.5SN OR BX	B.19
9995210000	LM 5.08/23/180 3.5SN OR BX	B.19
9995220000	LM 5.08/24/180 3.5SN OR BX	B.19

Addresses worldwide

- AE United Arab Emirates**
Weidmüller Middle East FZE
P.O. Box 8591, SAIF-Zone
Sharjah U. A. E.
Phone +971 6 5572723
Fax +971 6 5572724
wme.info@weidmuller.com
- AR Argentina**
CPI SA
Bauness 2660
1431 Buenos Aires
Phone +54 11 45238008
Fax +54 11 45220546
info@cpi.com.ar
www.cpi.com.ar
- AT Austria**
Weidmüller GmbH Austria
Straße 2, Industriezentrum M
Süd Straße 2b M59
2355 Wiener Neudorf
Phone +43 2236 6708-0
Fax +43 2236 6708-199
office.at@weidmuller.com
- AU Australia**
Weidmüller Pty. Ltd.
P.O. Box 6944
Huntingwood Drive 43
Huntingwood,
NSW, 2148
Phone +61 2 9671-9999
Fax +61 2 9671-9911
info@weidmuller.com.au
www.weidmuller.com.au
- AZ Azerbaijan**
West Industries Ltd.
Caspian Plaza, 5-th Floor
44 J. Jabbarly Str., Baku
Phone +99412 596 15 15
Fax +99412 596 14 93
sales@west-i.com
- BA Bosnia and Herzegovina**
Representative Office
Weidmüller Interface
GmbH & Co. KG
Beograd-Stari Grad
Danice Marković 2
11050 Beograd
Srbija
Phone +381 11 288 5274
Fax +381 11 288 5274
zoran.rabrenovic@weidmuller.com
- BH ES ELEKTROSISTEM d.o.o.
Bul. Vojvode S.
Stepanovica kod br. 272
78000 BiH - Banja Luka
Phone +387 51 420-340
Fax +387 51 420-341
elsist@inecco.net
www.elektrosistem.ba
- BE Belgium**
Weidmüller Benelux B.V.
Mechelsesteenweg 519 bus
6 en 7
1930 Nossegem
Phone +32 2 752 4070
Fax +32 2 751 3606
info@weidmuller.be
www.weidmuller.be
- BG Bulgaria**
Weid-Bul EOOD
1756 Sofia
13, bul. "Kliment Ohridski"
Phone +359 2 9632560
Fax +359 2 9631098
sofia@weidbul.com
www.weidbul.com
- BH Bahrain**
Khayber Trading Company
P.O. Box 1976 Manama,
Phone +973 720747
Fax +973 720331
khayber@batelco.com.bh
- BR Brazil**
Weidmüller Conexel do Brasil
Conexões Elétricas Ltda.
Rua Garcia Lora, 176
09695-900, Sao Paulo SP
Phone +55 11 43669600
Fax +55 11 43621677
vendas@weidmuller.com.br
www.weidmuller.com.br
- BY Belarus**
Technikon Ltd.
Nezavisimosti pr.177-9
Minsk 220125
Phone +375 17 3931177
Fax +375 17 3930080
wm@technikon.by
- CA Canada**
W Interconnections CANADA
Ltd.
10 Spy Court, Markham,
Ontario L3R 5H6
Phone +1 905 475-1507
Fax +1 905 475-2788
info1@weidmuller.ca
www.weidmuller.ca
- CH Switzerland**
Weidmüller Schweiz AG
Rundbuckstraße 2
8212 Neuhausen am Rheinfall
Phone +41 52 6740707
Fax +41 52 6740708
info@weidmuller.ch
www.weidmuller.ch
- CL Chile**
Felipe Bahamondes S.A./
ATS AGRO
Maria Luisa Santander 0475
Casilla 3425
Santiago
Phone +56 2 341-1271
Fax +56 2 341-1275
felipe@atsintech.com
- CPI CHILE LTDA
Av. Presidente Frei Montalva
6001-47, Conchali -
Region Metropolitana -
Santiago
cpi@cpichile.cl
- CN China**
Weidmüller Interface
International Trading
(Shanghai) Co., Ltd.
25F, BM Intercontinental
Business Center,
100 Yutong Road, Shanghai
200070
P.R. China
Phone +86 21 22195008
Fax +86 21 22195009
www.cnweidmuller.com
- CO Colombia**
Automatización Avanzada S. A.
Carrera 97 No.24c, 23 B4
4 Bogotá D. C.
Phone +57 1 5478510
Fax +57 1 4223044
comercial@
automatizacionavanzada.com
www.
automatizacionavanzada.com
- CR Costa Rica**
ELVATRON S.A.
la Uruca 400 Norte
Banco Costa Rica
San José Costa Rica
Phone +506 2 961060
Fax +506 5 200609
dirk.haase@elvatron.com
www.elvatron.com
- CZ Czech Republic**
Weidmüller s. r. o.
Lomnického 5/1705
14000 Praha 4
Phone +420 2 44001400
Fax +420 2 44001499
office@weidmuller.cz
www.weidmuller.cz
- DE Germany**
Weidmüller GmbH & Co. KG
Postfach 3054
32720 Detmold
Ohmstraße 9
32758 Detmold
Phone +49 5231 1428-0
Fax +49 5231 1428-116
weidmuller@weidmuller.de
www.weidmuller.de
- DK Denmark**
Wexøe A/S
Lejrvej 31
3500 Værløse
Phone +45 45465800
Fax +45 45465801
wexoe@wexoe.dk
www.wexoe.dk
- EC Ecuador**
Elsystec S. A. Electricidad
Sistemas y Tecnología
Vasco de Contreras N35-25
y Mañosa, Quito
Phone +593 2 2456510
Fax +593 2 2456755
Elsystec@uio.satnet.net
- EE Estonia**
Representative Office
Weidmüller Interface
GmbH & Co. KG
Udens str. 12-118
Riga, LV-1007
Latvia
Phone +371 29254766
Fax +371 6724562
ilgonis.rudaks@weidmuller.com
- Soots Interface OÜ
Pärnu mnt 142
11317 Tallinn
Phone +372 5296177
Fax +372 6096933
info@sootsinterface.ee
www.sootsinterface.ee
- EG Egypt**
Standard Electric (OMEGA)
87, Mohamed Farid Street
Heliopolis, Cairo
Phone +20 26422977
Fax +20 26422955
stdelec@rite.com
- ES Spain**
Weidmüller S. A.
Narcis Monturiol 11-13
Pol. Ind. Sudoste
08960 Sant Just Desvern
Barcelona
Phone +34 93 4803386
Fax +34 93 3718055
weidmuller@weidmuller.es
www.weidmuller.es
- FI Finland**
JUHA-ELEKTRO OY
P. O. Box 57, 641 Helsinki
Kylvöpolku 6, 680 Helsinki
Phone +358 10 8328 100
Fax +358 10 8328 109
info@juha-elektro.fi
www.juha-elektro.fi
- FR France**
Weidmüller E. U. R. L.
12, Chaussée Jules César
B.P. 263 Osny
95523 Cergy Pontoise Cedex
Phone +33 1 34245500
Fax +33 1 34245501
mail@weidmuller.fr
- GB Great Britain**
Weidmüller Ltd
Klippon House
Centurion Court Office
Meridian East, Meridian
Business Park
Leicester, LE19 1TP
Phone +44 1162 823470
Fax +44 1162 893582
marketing@weidmuller.co.uk
www.weidmuller.co.uk
- GR Greece**
Electrorama S.A.
1 An. Martali Str.
41335 Larissa
Phone +30 2410 55253188
Fax +30 2410 283463189
valvizes@electrorama.com.gr
- GA Contact Solutions
11, Ippokratou Str.
14452 Metamorfoisi Attika
Phone +30 210 2823233
Fax +30 210 2823233
gasaless@gmail.com
- HK Hong Kong**
Weidmüller (Hong Kong)
Limited
Unit 1617, The Metropolis
Tower, No.10, Metropolis
Drive, Hung Hom, Kowloon
Phone +852 31548082
Fax +852 31548099
info-hk@weidmuller.de
Hong Kong
- HR Croatia**
Elektro Partner d.o.o.
Slavonska Avenija 24/6
10000 Zagreb
Phone +385 1 6184793
Fax +385 1 6184795
elektropartner@zg.t-com.hr
- HU Hungary**
Weidmüller Kft
Gubacsi út 6
1097 Budapest
Phone +36 1 3827700
Fax +36 1 3827701
info@weidmuller.hu
- ID Indonesia**
PT. Nego Electrindo
Ruko Mega Grosir Cempaka
Mas, Blok I No 20 - 22
Jl. Let.Jend. Suprato -
Jakarta 10640
Phone +62 21 42882255
Fax +62 21 42882266
sales@negoelectrindo.co.id
- IE Ireland**
Please contact
Weidmüller Ltd.
in Great Britain
- IL Israel**
A.U.Shay Ltd.
P.O. Box 10049
Embar Street 23/25
43222 Petach-Tikva
Phone +972 3 9233601
Fax +972 3 9234601
- ATEKA Ltd.
4, Ha Tavor lane
Industrial area Segula
49691 Petach-Tikva
Phone +972 73 2001311
Fax +972 3 9244245
marketing@ateka.co.il
www.ateka.co.il
- IN India**
Weidmüller
Electronics India Pvt. Ltd
Plot # 32, 3rd Floor,
North Court
Lane North Avenue,
Opp Jogger's Park
Kalyani Nagar, Maharastra
411006 Pune
Phone +91 9049800960
Nitish.Rajan@weidmuller.de
- IS Iceland**
Samey Automation Center
Lyngas 13, 210 Garoabaer,
Phone +354 510 5200
Fax +354 510 5201
samey@samey.is
- IT Italy**
Weidmüller S.R.L.
Via Albert Einstein 4
20092 Cinisello Balsamo
Milano
Phone +39 02 660681
Fax +39 02 6124945
weidmuller@weidmuller.it
www.weidmuller.it
- JO Jordan**
HORIZONS
P.O.Box: 330607
Amman Jordan 11133
Phone +962 6 4882114
Fax +962 6 4882115
horizons@go.com.jo
- JP Japan**
Nihon Weidmüller Co. Ltd.
Sphere Tower Tennoz,
2-2-8 Higashi-Shinagawa,
Shinagawa-Ku,
Tokyo 140-0002
Phone +81 3 6711-5300
Fax +81 3 6711-5333
www.weidmuller.co.jp
- KR Korea**
Weidmüller Korea Co. Ltd.
6F Seokyoung B/D,
242-54 Nonhyun-dong,
Gangnam-gu
Seoul, 135-830
Phone +82 2 5160003
Fax +82 2 5160090
info@weidmuller.co.kr
- KW Kuwait**
KANA CONTROLS General
Trading & Com. CO. W.L.L.
Al Rai Industrial Area,
Plot 28-30, St. 31
P.O.Box: 25593
Safat, 13016
Phone +966-474 1373/4
Fax +966-474 1537
info@kanacontrols.com
- LB Lebanon**
Progress Engineering &
Trading Enterprises
Al Nahr Street, Beirut
Phone +961 1 444664
Fax +961 1 561880
progress@inco.com.lb
- LT Lithuania**
Representative Office
Weidmüller Interface
GmbH & Co. KG
Udens str. 12-118
Riga, LV-1007
Latvia
Phone +371 29254766
Fax +371 6724562
ilgonis.rudaks@weidmuller.com
- ELEKTROS IRANGA
Tinklu g.29a, 5319 Panevezys
Phone +370 45582828
Fax +370 45582727
info@eliranga.lt
- LU Luxembourg**
Please contact
Weidmüller Benelux B.V.
in the Netherlands
- LV Latvia**
Representative Office
Weidmüller Interface
GmbH & Co. KG
Udens str. 12-118
Riga, LV-1007
Latvia
Phone +371 29254766
Fax +371 6724562
ilgonis.rudaks@weidmuller.com
- SIA "ABIA"
Daugavgrivas str. 31b
1007 Riga
Phone +371 67470999
Fax +371 67465637
abi_4@tvnet.lv
- MD Moldova**
BERHORD A&D srl
44, str. Sarmizgetusa 37/3
Of. art. b-dul Decebal, 3,
Chisinau, MD 2001
Phone +373 22 507137
Fax +373 22 507134
atiuleanu@berhord.com
- ME Montenegro**
Representative Office
Weidmüller Interface
GmbH & Co. KG
Beograd-Stari Grad
Danice Marković 2
11050 Beograd
Srbija
Phone +381 11 288 5274
Fax +381 11 288 5274
zoran.rabrenovic@weidmuller.com
- MK Macedonia**
Representative Office
Weidmüller Interface
GmbH & Co. KG
Beograd-Stari Grad
Danice Marković 2
11050 Beograd
Srbija
Phone +381 11 288 5274
Fax +381 11 288 5274
zoran.rabrenovic@weidmuller.com
- ELEKTRO - SMK doool
UL III Makedonska brigada b.b.
1000 Skopje
Phone +389 22 460 295
Fax +389 22 460 298
Elektro-smk@telekabel.net.mk

Group companies **DE**Agency abroad **DE**Without own Agency **DE**

- MT Malta**
E. S. S., Electrical Supplies & Services Ltd
104 J. Sciberras Str.
Hamrun HMR 08
Phone +356 21 255 777
Fax +356 21 255 999
robert@ess.com.mt
- MU Mauritius**
MUBELO Electrical Ltd
Office 26, Gateway building,
St Jean Road, Quatre Bornes
Phone +230 467 0989
Fax +230 465 4051
richard.mubelo@orange.mu
- MX Mexico**
W Interconnections,
S.A. DE C.V.
Blvd. Hermanos Serdán
No. 698
Col. San Rafael Oriente
Puebla, C.P. 72029
Phone +52 222 22686227
clientes@weidmuller.com.mx
- MY Malaysia**
Connect Plus Technology
Sdn Bhd
No. 43, Jalan PJS, 11/22,
Bandar Sunway,
46150 Petaling Jaya
Selangor Darul Ehsan
Phone +60 3 5633 7363
Fax +60 3-5633 6562
paul@cptech.com.my
www.cptech.com.my
- NL Netherlands**
Weidmüller Benelux B.V.
Franciscusweg 221
1216 SE Hilversum
Postbus 1505
1200 BM Hilversum
Phone +31 35 6261261
Fax +31 35 6232044
info@weidmuller.nl
www.weidmuller.nl
- NO Norway**
Siv. Ing. J. F. Knudtzen A/S
Billingstadsletta 97
P.O. Box 160
1378 Nesbru
Phone +47 66 983350
Fax +47 66 980955
firmapost@jfknuetzen.no
www.jfknuetzen.no
- NZ New Zealand**
Cuthbert S. Steward Limited
27 Te Pahi Street
POB 38496
Petone, Wellington
Phone +64 4 5686156
Fax +64 4 5686056
info@weidmueller.de
- OM Oman**
DAN INTERNATIONAL LLC.
P.O. BOX 2901
111 Seeb
Phone +968 503 677
Fax +968 503 755
yedu@danintl.com
- PE Peru**
IMPEXINCA S.A.C.
Calle Ortiz de Zevallos N° 105,
18 Lima, Miraflores,
Phone +51 11 447 5608
info@impexinca.pe
- J & W CIA. S.A.
Calle 6 Mz. D Lte. 23
Urb. Ind. Grimanesa
Callao 01
Phone +51 1 57 22539
Fax +51 1 57 20152
lespinoza@jwcia.com
www.jwcia.com
- PH Philippines**
Enclosure Systems Specialists Inc
Room 103 Narra Building
2276 Don Chino Roces
Avenue
Makati City 1231
Phone +63 2 813 8580
Fax +63 2 813 8596
sales_encsys@pldtdsl.net
- PK Pakistan**
Kana Controls (Pak)
Apartment No. 33 C III
Chenab Block,
Allama Iqbal Town
Lahore, Pakistan
Phone +92 42 5419948
+92 42 7845160
Fax +92 42 5422895
nadeem@kanapak.com
www.kanapak.com
- PL Poland**
Weidmüller Sp. z o.o.
Ul. Golezdzinowska 10
03-302 Warszawa
Phone +48 22 5100940
Fax +48 22 5100941
biuro@weidmuller.com.pl
www.weidmuller.pl
- PT Portugal**
Weidmüller Sistemas de
Interface S. A.
Estrada Outeiro Polima,
R. Augusto
Dias da Silva, Lote B, Esc. 2
2785-515 Abóboda - São
Domingos de Rana
Phone +351 21 4459191
Fax +351 21 4455871
www.weidmueller.pt
- QA Qatar**
Doha Motors Trading Co.
(Technical Division)
Post Box No. 145
Airport Road
Doha - Qatar
Phone +974 465 1441
Fax +974 465 0925
dmtctech@qatar.net.qa
- RO Romania**
Weidmüller Interface
GmbH & Co.KG
Representative Office - Romania
Brasov Business Park
Ionescu Crum Street, no. 1
1st Tower, 1st Floor, Office 4
RO- 500446 Brasov
Romania
Phone +40 268 446 222
Fax +40 268 446 224
claudiu.totea@weidmueller.com
- RS Serbia**
Representative Office
Weidmüller Interface
GmbH & Co. KG
Ustanička 189, III sprat,
lokal 7a
11050 Beograd
Phone +381 11 288 5274
Fax +381 11 288 5274
zoran.rabrenovic@
weidmueller.com
- ES-YU Elektrosistem
Pariske komune 4 1
11070 Novi Beograd, Serbia
Phone +381 11 3018660
Fax +381 11 2693608
esyu@eunet.rs
- RU Russia**
OOO Weidmüller
Warshavskoye highway, 25A,
bld. 6
117105 Moskau
Phone +7 4 95 771-6940
Fax +7 4 95 771-6941
info@weidmueller.ru
www.weidmueller.ru
- SA Saudi-Arabia**
Al Abdulkarim Holding Co.
P.O. Box. 4
Dammam 31411
Phone +9668337110
Fax +9668338242
salehsk@akh.com.sa
www.weidmueller.ae
- Saudi Electric Supply Co.
P.O. Box 3298
Al Khobar 31952
Phone +966 3 882 9546227
Fax +966 3 882 9547
Safdar.malik@sesco-ge.com
- SE Sweden**
Weidmüller AB
Axel Dariessons väg 271
P.O. box 31025
200 49 Malmö
Phone +46 (0) 7 71 43 00 44
Fax +46 (0) 40 37 48 60
info@weidmuller.se
www.weidmuller.se
- SG Singapore**
Weidmüller Pte. Ltd.
70 Bendemeer Road
#04-03 Luzerne
Singapore 339940
Phone +65 6841 5311
Fax +65 6841 5377
info@weidmuller.com.sg
www.weidmuller.com.sg
- SI Slovenia**
ELEKTROPOJJI d.o.o.
Stegne 25, 1000 Ljubljana
Phone +386 15113810
Fax +386 15111604
info@elektropojji.si
www.elektropojji.si
- SK Slovakia**
ELEKTRIS s.r.o.
Elektrárenská 1
83104 Bratislava
Phone +421 2 49200113
Fax +421 2 49200119
bratislava@elektris.sk
- TH Thailand**
Pisanu Engineering Co., Ltd
800/43-45 Soi Trakulsuk
Asoke-dindaeng Road,
Dindaeng, Bangkok 10400
Phone +66 2 245 9113
Fax +66 2 6429220
jayasankar@pisanu.co.th
www.pisanu.co.th
- TN Tunisia**
Please contact
Weidmüller E.U.R.L.
in France
- TR Turkey**
Weidmüller Elektronik Ticaret
Ltd. Sirketi
Kavacik Mah. Orhan Veli Kanik
Kavacik 9/1
34810 Beykoz - Istanbul
Phone +90 216 5371070 (Pbx)
Fax +90 216 5371077
info@weidmuller.com.tr
www.weidmuller.com.tr
- TW Taiwan**
Fittatek Co., Ltd.
12F No. 185 Fu-Kuo Road,
Tso Ying Dist. Kaohsiung
Phone +886 7 556 0858
Fax +886 7 556 3279
stanley@fittatek.com.tw
www.fittatek.com.tw
- Eucan Enterprise Ltd.
No. 145 He Ping 2nd Rd
Kaohsiung
Phone +886 7 715 6610
Fax +886 7 715 8748
mark@eucan.com.tw
www.eucan.com.tw
- UA Ukraine**
TEKO INTERFACE
Lomonosova str. 73g
03022 Kiev
Phone +38 044 3740640
Fax +38 044 3740642
weidmueller@tekointerface.com.ua
www.tekointerface.com.ua
- US United States**
W-Interconnections Inc.
821 Southlake Boulevard,
Virginia - Richmond 23236
Phone +1 804 7942877
Fax +1 804 3792593
info@weidmuller.com
www.weidmuller.com
- UY Uruguay**
REVIVO Uruguay S.A
AV. Bolivia 2001 Esq Rocafuerte
Carrasco Montevideo 11300
Phone / Fax +598 260 48439
clorda@revouruguay.com.uy
- UZ Uzbekistan**
OOO "Elektro Potential"
Gani Mavlanova str., 2B
100084 Tashkent
Phone +998 98-3003821
Fax +998 71-1249286
mz1958@yandex.ru
- VE Venezuela**
Somerinca C.A.
Quinta Sagrado Corazon
de Jesus -
3ra Transversal -
Los Dos Caminos,
Caracas 1070 - A
Phone +58 212 2352748
Fax +58 212 2399341
klocmoeller@cantv.net
www.kmsomerinca.com.ve
- VN Vietnam**
AUMI Co., Ltd
E1, La Thanh Hotel,
218 Doi Can Street,
Lieu Giai Ward, Ba Dinh District,
Hanoi City
Phone +84 4762 8601
Fax +84 4266 1391
aumi@aumi.com.vn
- LinH Kim Hai Co., Ltd
78 Hoa Cuc Street Ward 7,
Phu Bhuang District,
Ho Chi Minh City
Phone +84 8517 1717
Fax +84 8517 1818
lkh@linhkimhai.com.vn
- ZA South Africa**
Phambili Interface (Pty) Ltd
P.O. Box 193,
1609 Johannesburg
5 Bundo Road, Sebenza
1610 Johannesburg,
Endersvale
Phone +27 11 452 1930
Fax +27 11 452 6455
sales@radinterface.co.za
www.radinterface.co.za
- DE Other countries**
Weidmüller Interface GmbH
& Co. KG
Postfach 3030
32720 Detmold
Klingenbergstraße 16
32758 Detmold
Phone +49 5231 14-0
Fax +49 5231 14-292083
info@weidmueller.de
www.weidmueller.com

We cannot guarantee that there are no mistakes in the publications or software provided by us to the customer for the purpose of making orders. We try our best to quickly correct errors in our printed media.

X

All orders are based on our general terms of delivery, which can be reviewed on the websites of our group companies where you place your order. On demand we can also send the general terms of delivery to you.

Weidmüller – Partner in Industrial Connectivity

As experienced experts we support our customers and partners around the world with products, solutions and services in the industrial environment of power, signal and data. We are at home in their industries and markets and know the technological challenges of tomorrow. We are therefore continuously developing innovative, sustainable and useful solutions for their individual needs. Together we set standards in Industrial Connectivity.

Weidmüller Interface GmbH & Co. KG
Klingenbergstraße 16
32758 Detmold, Germany
T +49 5231 14-0
F +49 5231 14-292083
info@weidmueller.com
www.weidmueller.com



Order number: 1381510000/01/2013/SMDM