



A New Direction in Mixed-Signal

SP481E / SP485E

Enhanced Low Power Half-Duplex RS-485 Transceivers

- +5V Only
- Low Power BiCMOS
- Driver / Receiver Enable for Multi-Drop configurations
- Low Power Shutdown mode (**SP481E**)
- Enhanced ESD Specifications:
 - +/-15kV Human Body Model
 - +/-15kV IEC61000-4-2 Air Discharge
- Available in RoHS Compliant, Lead Free Packaging.

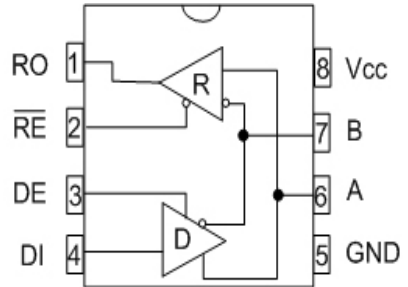

SP481E and SP485E
Pinout (Top View)

DESCRIPTION

The **SP481E** and **SP485E** are a family of half-duplex transceivers that meet the specifications of RS-485 and RS-422 serial protocols with enhanced ESD performance. The ESD tolerance has been improved on these devices to over $\pm 15\text{kV}$ for both Human Body Model and IEC61000-4-2 Air Discharge Method. These devices are pin-to-pin compatible with **Exar's** SP481 and SP485 devices as well as popular industry standards. As with the original versions, the **SP481E** and **SP485E** feature **Exar's** BiCMOS design allowing low power operation without sacrificing performance. The **SP481E** and **SP485E** meet the requirements of the RS-485 and RS-422 protocols up to 10Mbps under load. The **SP481E** is equipped with a low power shutdown mode.

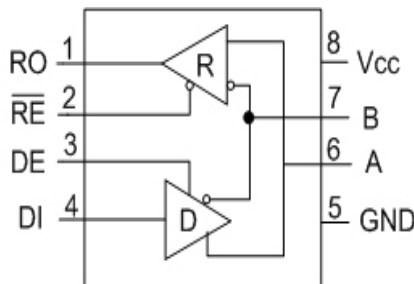

SP481E and SP485E

ABSOLUTE MAXIMUM RATINGS

These are stress ratings only and functional operation of the device at these ratings or any other above those indicated in the operation sections of the specifications below is not implied. Exposure to absolute maximum rating conditions for extended periods of time may affect reliability.

V_{CC}.....+7V

Input Voltages

Logic.....-0.3V to (V_{CC} + 0.5V)

Drivers.....-0.3V to (V_{CC} + 0.5V)

Receivers.....+/-15V

Output Voltages

Logic.....-0.3V to (V_{CC} + 0.5V)

Drivers.....+/-15V

Receivers.....-0.3V to (V_{CC} + 0.5V)

Storage Temperature.....-65°C to +150°C

Power Dissipation

8-pin NSOIC.....550mW
(derate 6.60mW/°C above +70°C)

8-pin PDIP.....1000mW
(derate 11.8mW/°C above +70°C)

ELECTRICAL CHARACTERISTICS

T_{MIN} to T_{MAX} and V_{CC} = +5.0V +/-5% unless otherwise noted.

PARAMETERS	MIN.	TYP.	MAX.	UNITS	CONDITIONS
SP481E/SP485E DRIVER					
DC Characteristics					
Differential Output Voltage	GND		V _{CC}	Volts	Unloaded; R = ∞ ; see Figure 1
Differential Output Voltage	2		V _{CC}	Volts	With Load; R = 50Ω (RS-422); see Figure 1
Differential Output Voltage	1.5		V _{CC}	Volts	With Load; R = 27Ω (RS-485); see Figure 1
Change in Magnitude of Driver Differential Output Voltage for Complimentary states			0.2	Volts	R = 27Ω or R = 50Ω; see Figure 1
Driver Common Mode Output Voltage			3	Volts	R = 27Ω or R = 50Ω; see Figure 1
Input High Voltage	2.0			Volts	Applies to DE, DI, \overline{RE}
Input Low Voltage			0.8	Volts	Applies to DE, DI, \overline{RE}
Input Current			+/-10	μA	Applies to DE, DI, \overline{RE}
Driver Short Circuit Current					
V _{OUT} = HIGH			+/-250	mA	-7V ≤ V _O ≤ +12V
V _{OUT} = LOW			+/-250	mA	-7V ≤ V _O ≤ +12V
SP481E/SP485E DRIVER					
AC Characteristics					
Max. Transmission Rate	10			Mbps	\overline{RE} = 5V, DE = 5V; R _{DIFF} = 54Ω, C _{L1} = C _{L2} = 100pF
Driver Input to Output, t _{PLH}		30	60	ns	See Figures 3 & 5, R _{DIFF} = 54Ω, C _{L1} = C _{L2} = 100pF
Driver Input to Output, t _{PLH} (SP485EMN ONLY)		30	80	ns	
Driver Input to Output, t _{PHL}		30	60	ns	See Figures 3 & 5, R _{DIFF} = 54Ω, C _{L1} = C _{L2} = 100pF
Driver Input to Output, t _{PHL} (SP485EMN ONLY)		30	80	ns	
Driver Skew		5	10	ns	see Figures 3 and 5, t _{SKREW} = t _{DPHL} - t _{DPLH}
Driver Rise or Fall Time		15	40	ns	From 10%-90%; R _{DIFF} = 54Ω C _{L1} = C _{L2} = 100pF; see Figures 3 and 6

ELECTRICAL CHARACTERISTICS

T_{MIN} to T_{MAX} and $V_{CC} = +5.0V \pm 5\%$ unless otherwise noted.

PARAMETERS	MIN.	TYP.	MAX.	UNITS	CONDITIONS
SP481E/SP485E DRIVER (continued)					
AC Characteristics					
Driver Enable to Output High		40	70	ns	$C_L = 100pF$, see Figures 4 and 6, S_2 closed
Driver Enable to Output Low		40	70	ns	$C_L = 100pF$, see Figures 4 and 6, S_1 closed
Driver Disable Time from High		40	70	ns	$C_L = 100pF$, see Figures 4 and 6, S_2 closed
Driver Disable Time from Low		40	70	ns	$C_L = 100pF$, see Figures 4 and 6, S_1 closed
SP481E/SP485E RECEIVER					
DC Characteristics					
Differential Input Threshold	-0.2		+0.2	Volts	$-7V \leq V_{CM} \leq +12V$
Differential Input Threshold (SP485EMN ONLY)	-0.4		+0.4	Volts	$-7V \leq V_{CM} \leq +12V$
Input Hysteresis		20		mV	$V_{CM} = 0V$
Output Voltage High	3.5			Volts	$I_O = -4mA$, $V_{ID} = +200mV$
Output Voltage Low			0.4	Volts	$I_O = +4mA$, $V_{ID} = +200mV$
Three-State (High Impedance) Output Current			+/-1	μA	$0.4V \leq V_O \leq 2.4V$; $\overline{RE} = 5V$
Input Resistance	12	15		k Ω	$-7V \leq V_{CM} \leq +12V$
Input Current (A, B); $V_{IN} = 12V$			+1.0	mA	$DE = 0V$, $V_{CC} = 0V$ or $5.25V$, $V_{IN} = 12V$
Input Current (A, B); $V_{IN} = -7V$			-0.8	mA	$DE = 0V$, $V_{CC} = 0V$ or $5.25V$, $V_{IN} = -7V$
Short Circuit Current	7		95	mA	$0V \leq V_O \leq V_{CC}$
SP481E/SP485E RECEIVER					
AC Characteristics					
Max. Transmission Rate	10			Mbps	$\overline{RE} = 0V$, $DE = 0V$
Receiver Input to Output	20	45	100	ns	t_{PLH} : See Figures 3 & 7, $R_{DIFF} = 54\Omega$, $C_{L1} = C_{L2} = 100pF$
Receiver Input to Output	20	45	100	ns	t_{PHL} : See Figures 3 & 7, $R_{DIFF} = 54\Omega$, $C_{L1} = C_{L2} = 100pF$
Differential Receiver Skew $ t_{PHL} - t_{PLH} $		13		ns	$R_{DIFF} = 54\Omega$, $C_{L1} = C_{L2} = 100pF$, see Figures 3 and 7
Receiver Enable to Output Low		45	70	ns	$C_{RL} = 15pF$, Figures 2 & 8; S_1 Closed
Receiver Enable to Output High		45	70	ns	$C_{RL} = 15pF$, Figures 2 & 8; S_2 Closed
Receiver Disable from LOW		45	70	ns	$C_{RL} = 15pF$, Figures 2 & 8; S_1 Closed
Receiver Disable from High		45	70	ns	$C_{RL} = 15pF$, Figures 2 & 8; S_2 Closed

ELECTRICAL CHARACTERISTICS

T_{MIN} to T_{MAX} and $V_{CC} = +5.0V \pm 5\%$ unless otherwise noted.

PARAMETERS	MIN.	TYP.	MAX.	UNITS	CONDITIONS
SP481E					
Shutdown Timing					
Time to Shutdown	50	200	600	ns	$\overline{RE} = 5V, DE = 0V$
Driver Enable from Shutdown to Output High		40	100	ns	$C_L = 100pF$; See Figures 4 and 6; S_2 Closed
Driver Enable from Shutdown to Output Low		40	100	ns	$C_L = 100pF$; See Figures 4 and 6; S_1 Closed
Receiver Enable from Shutdown to Output High		300	1000	ns	$C_L = 15pF$; See Figures 2 and 8; S_2 Closed
Receiver Enable from Shutdown to Output Low		300	1000	ns	$C_L = 15pF$; See Figures 2 and 8; S_1 Closed
POWER REQUIREMENTS					
Supply Voltage V_{CC}	+4.75		+5.25	Volts	
Supply Current					
SP481E/SP485E					
No Load		900		μA	$\overline{RE}, DI = 0V$ or V_{CC} ; $DE = V_{CC}$
		600		μA	$\overline{RE} = 0V, DI = 0V$ or $5V$; $DE = 0V$
SP481E					
Shutdown Mode			10	μA	$DE = 0V, \overline{RE} = V_{CC}$
ENVIRONMENTAL AND MECHANICAL					
Operating Temperature					
Commercial ($_{C}$)	0		70	$^{\circ}C$	
Industrial ($_{E}$)	-40		+85	$^{\circ}C$	
($_{M}$)	-40		+125	$^{\circ}C$	
Storage Temperature	-65		+150	$^{\circ}C$	
Package					
Plastic DIP ($_{P}$)					
NSOIC ($_{N}$)					

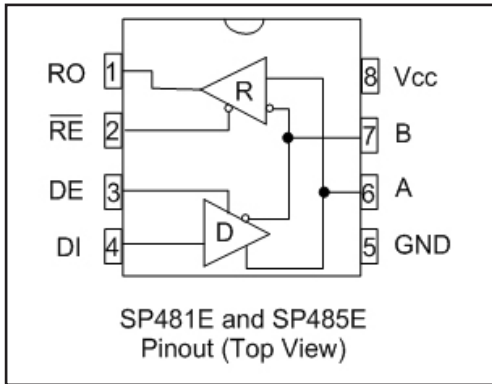

- Pin 1 - RO - Receiver Output
- Pin 2 - \overline{RE} - Receiver Output Enable Active LOW
- Pin 3 - DE - Driver Output Enable Active HIGH
- Pin 4 DI - Driver Input
- Pin 5 - GND - Ground Connection
- Pin 6 - A - Driver Output / Receiver input
Non-Inverting
- Pin 7 - B - Driver Output / Receiver Input Inverting
- Pin 8 - Vcc - Positive Supply $4.75V \leq V_{cc} \leq 5.25V$

TEST CIRCUITS

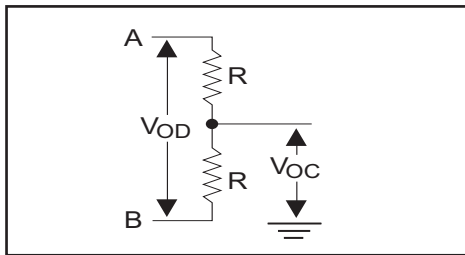

Figure 1. RS-485 Driver DC Test Load Circuit

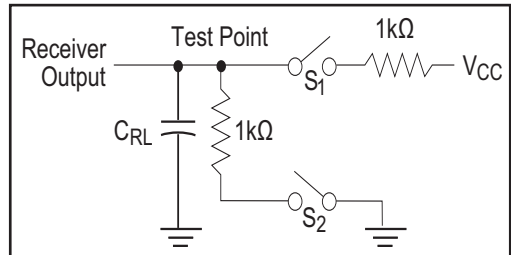

Figure 2. Receiver Timing Test Load Circuit

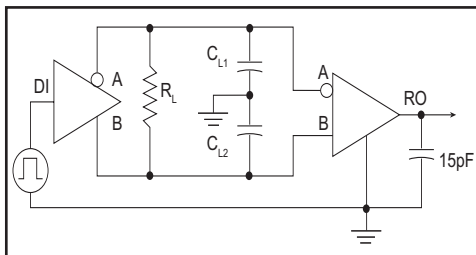

Figure 3. RS-485 Driver/Receiver Timing Test

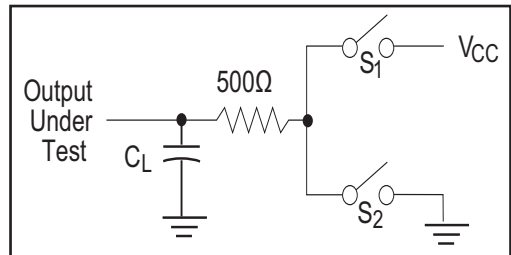

Figure 4. Driver Timing Test Load #2 Circuit

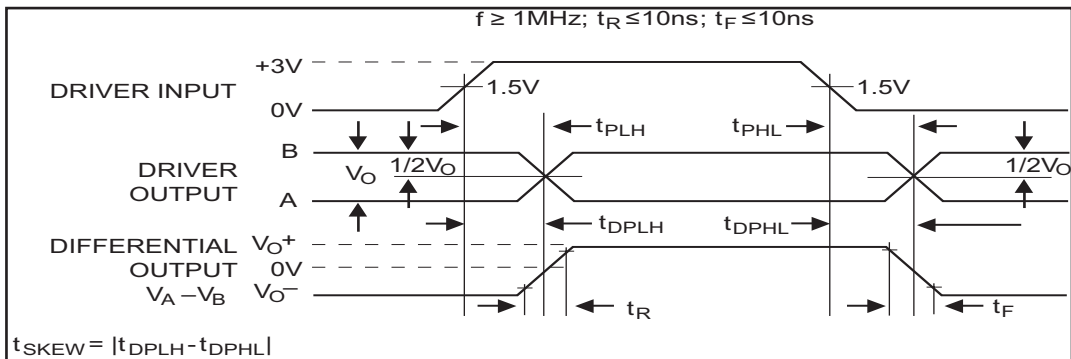

Figure 5. Driver Propagation Delays

FUNCTION TRUTH TABLES

INPUTS			LINE CONDITION	OUTPUTS	
\overline{RE}	DE	DI		A	B
X	1	1	No Fault	1	0
X	1	0	No Fault	0	1
X	0	X	X	Z	Z
X	1	X	Fault	Z	Z

Table 1. Transmit Function Truth Table

INPUTS		A - B	OUTPUTS
\overline{RE}	DE		R
0	0	+0.2V	1
0	0	-0.2V	0
0	0	Inputs Open	1
1	0	X	Z

Table 2. Receive Function Truth Table

SWITCHING WAVEFORMS

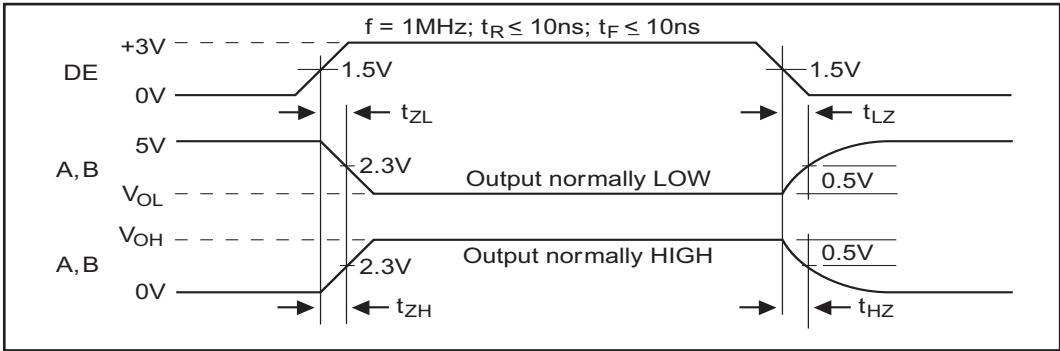

Figure 6. Driver Enable and Disable Times

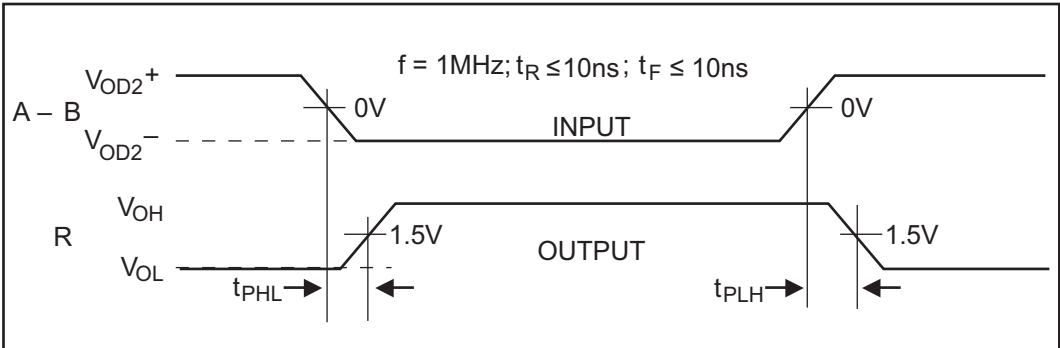

Figure 7. Receiver Propagation Delays

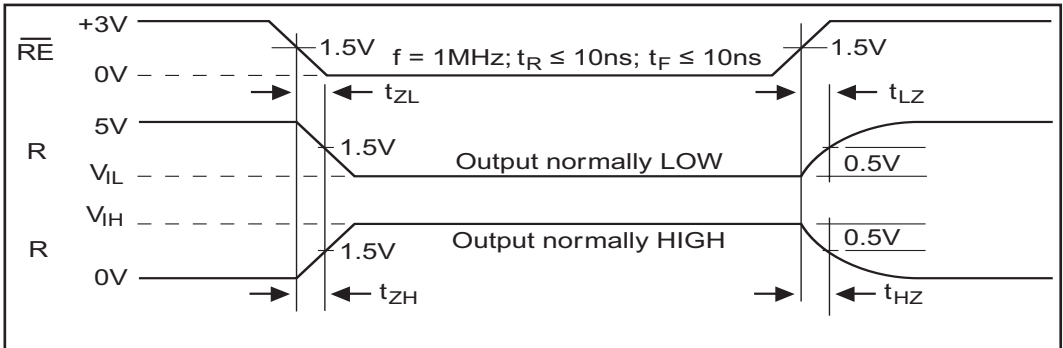

Figure 8. Receiver Enable and Disable Times

The **SP481E** and **SP485E** are half-duplex differential transceivers that meet the requirements of RS-485 and RS-422. Fabricated with an **Exar** proprietary BiCMOS process, this product requires a fraction of the power of older bipolar designs.

The RS-485 standard is ideal for multi-drop applications and for long-distance interfaces. RS-485 allows up to 32 drivers and 32 receivers to be connected to a data bus, making it an ideal choice for multi-drop applications. Since the cabling can be as long as 4,000 feet, RS-485 transceivers are equipped with a wide (-7V to +12V) common mode range to accommodate ground potential differences. Because RS-485 is a differential interface, data is virtually immune to noise in the transmission line.

Drivers

The driver outputs of the **SP481E** and **SP485E** are differential outputs meeting the RS-485 and RS-422 standards. The typical voltage output swing with no load will be 0 Volts to +5 Volts. With worst case loading of 54Ω across the differential outputs, the drivers can maintain greater than 1.5V voltage levels. The drivers of the **SP481E** and **SP485E** have an enable control line which is active HIGH. A logic HIGH on DE (pin 3) will enable the differential driver outputs. A logic LOW on the DE(pin 3) will tri-state the driver outputs.

The transmitters of the **SP481E** and **SP485E** will operate up to at least 10Mbps.

Receivers

The **SP481E** and **SP485E** receivers have differential inputs with an input sensitivity as low as ±200mV. Input impedance of the receivers is typically 15kΩ (12kΩ minimum). A wide common mode range of -7V to +12V allows for large ground potential differences between systems. The receivers of the **SP481E** and **SP485E** have a tri-state enable control pin. A logic LOW on \overline{RE} (pin 2) will enable the receiver, a logic HIGH on \overline{RE} (pin 2) will disable the receiver.

The receiver for the **SP481E** and **SP485E** will operate up to at least 10Mbps. The receiver for each of the two devices is equipped with the fail-safe feature. Fail-safe guarantees that the receiver output will be in a HIGH state when the input is left unconnected.

Shutdown Mode SP481E

The **SP481E** is equipped with a Shutdown mode. TO enable the shutdown state, both driver and receiver must be disabled simultaneously. A logic LOW on DE (pin 3) and a Logic HIGH on \overline{RE} (pin 2) will put the **SP481E** into Shutdown mode. In Shutdown, supply current will drop to typically 1μA.

REVISION HISTORY			
REV	DESCRIPTION	DATE	APP'D
A	DRAWING ORIGINATION	08/16/05	JL
B	DRAWING FORMAT MODIFICATION	07/19/06	JL
C	CHANGE DRAWING LOGO AND COMPANY NAME	11/16/07	JL

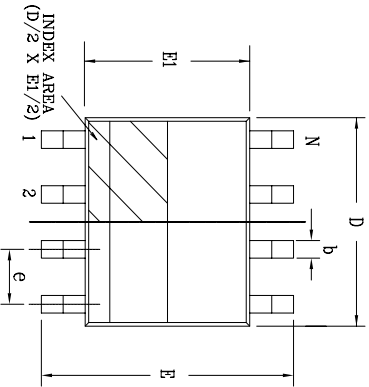

SYMBOLS	8 Pin SOICN			JEDEC MS-012			Variation AA		
	DIMENSIONS IN MM (Control Unit)			DIMENSIONS IN INCH (Reference Unit)					
	MIN	NOM	MAX	MIN	NOM	MAX			
A	1.35	—	1.75	0.053	—	0.069			
A1	0.10	—	0.25	0.004	—	0.010			
A2	1.25	—	1.65	0.049	—	0.065			
b	0.31	—	0.51	0.012	—	0.020			
c	0.17	—	0.25	0.007	—	0.010			
E	6.00 BSC			0.236 BSC					
E1	3.90 BSC			0.154 BSC					
e	0.25	—	0.50	0.010	—	0.020			
h	0.40	—	1.27	0.016	—	0.050			
L1	1.04 REF			0.041 REF					
L2	0.25 BSC			0.010 BSC					
R	0.07	—	—	0.003	—	—			
R1	0.07	—	—	0.003	—	—			
θ	0°	—	8°	0°	—	8°			
θ1	5°	—	15°	5°	—	15°			
θ2	0°	—	—	0°	—	—			
D	4.90 BSC			0.193 BSC					
N	8			8					

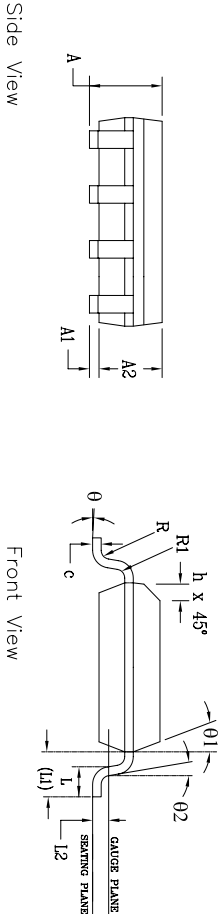

Side View

Side View diagram showing the package profile with dimensions A, A1, and A2.

Front View

EXAR CORPORATION
Revolutionary Connectivity

EXAR CORPORATION
 8 PIN SOICN PACKAGE OUTLINE

Packaging Approval: _____
 By: JL Date: 11/16/07 Drawing No: 8-PIN SOICN
 Revision: C Sheet: 1 OF 1

REVISION HISTORY			
REV/	DESCRIPTION	DATE	APP'D
A	DRAWING ORIGINATOR	04/26/06	JL
B	CHANGE DRAWING LOGO AND COMPANY NAME	11/28/07	JL

REMARKS:
 FOR 8LD AND 16LD
 ALL END LEADS (4X)
 ARE HALF LEAD TYPES

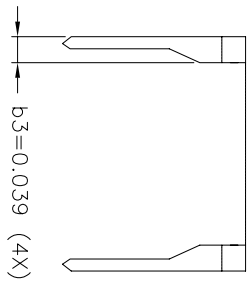
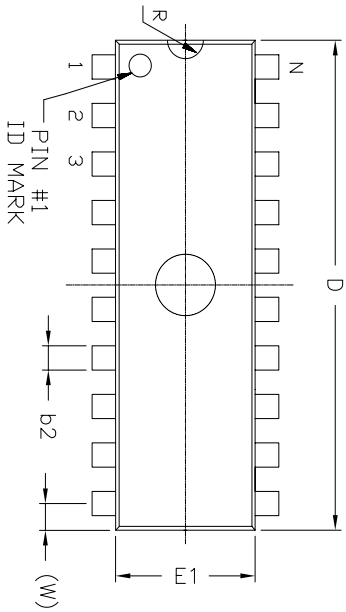

Top View

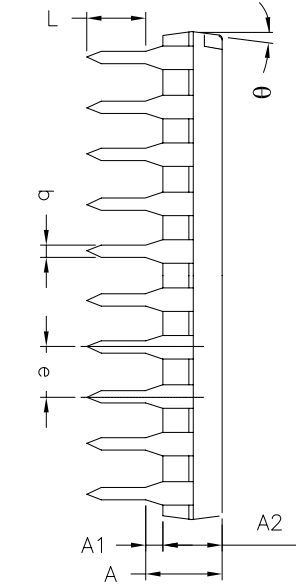

Side View

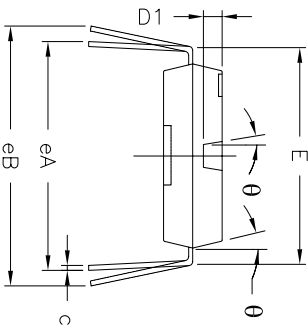

Front View

8 Pin PDIP JEDEC MS-001 Variation BA						
SYMBOLS	DIMENSIONS IN INCH (Control Unit)			DIMENSIONS IN MM (Reference Unit)		
	MIN	NOM	MAX	MIN	NOM	MAX
A	—	—	0.210	—	—	5.33
A1	0.015	—	—	0.38	—	—
A2	0.115	0.130	0.195	2.92	3.30	4.95
b	0.014	0.018	0.022	0.36	0.46	0.56
b2	0.045	0.060	0.070	1.14	1.52	1.78
c	0.008	0.010	0.014	0.20	0.25	0.36
D1	0.030	—	0.060	0.76	—	1.52
E	0.300	0.310	0.325	7.62	7.87	8.26
E1	0.240	0.250	0.280	6.10	6.35	7.11
e	0.100 BSC			2.54 BSC		
eA	0.300 BSC			7.62 BSC		
eB	—	—	0.430	—	—	10.92
L	0.115	0.130	0.150	2.92	3.30	3.81
W	0.075 REF			1.91 REF		
R	0.030 BSC			0.76 BSC		
theta	4°	7°	10°	4°	7°	10°
D	0.355	0.365	0.400	9.02	9.27	10.16
N	8			8		



EXAR CORPORATION

8 PIN PDIP PACKAGE OUTLINE

Packaging Approval:

Drawing No: 8-PIN PDIP

By: JL Date: 11/28/07

Revision: B Sheet: 1 OF 1

ORDERING INFORMATION

Model	Temperature Range	Package Types
SP481ECN-L.....	0°C to +70°C.....	8-pin NSOIC
SP481ECN-L/TR.....	0°C to +70°C.....	8-pin NSOIC
SP481EEN-L.....	-40°C to +85°C.....	8-pin NSOIC
SP481EEN-L/TR.....	-40°C to +85°C.....	8-pin NSOIC
SP485ECN-L.....	0°C to +70°C.....	8-pin NSOIC
SP485ECN-L/TR.....	0°C to +70°C.....	8-pin NSOIC
SP485ECP-L.....	0°C to +70°C.....	8-pin PDIP
SP485EEN-L.....	-40°C to +85°C.....	8-pin NSOIC
SP485EEN-L/TR.....	-40°C to +85°C.....	8-pin NSOIC
SP485EEP-L.....	-40°C to +85°C.....	8-pin PDIP
SP485EMN-L.....	-40°C to +125°C.....	8-pin NSOIC
SP485EMN-L/TR.....	-40°C to +125°C.....	8-pin NSOIC

Note: /TR = Tape and Reel

REVISION HISTORY

DATE	REVISION	DESCRIPTION
May 11/07	--	Legacy Sipex Datasheet
12/18/08	1.0.0	Convert to Exar Format. Update ordering information as a result of discontinued Lead type package options per PDN 081126-01. Remove "Top Mark" information from ordering page.
11/19/09	1.0.1	Correct table 1 error for driver output A and B outputs
08/08/10	1.0.2	Change SP485EMN-L and SP485EMN-L/TR temperature range error from +85C to +125C in ordering information section.
05/27/11	1.0.3	Remove driver minimum limits of propagation delay and Rise/Fall time. Remove SP481ECP-L and SP481EEP-L per PDN 110510-01
05/24/13	1.0.4	Correct type errors per PCN 13-0503-01 ECN: 1322-04 05/29/2013

Notice

EXAR Corporation reserves the right to make changes to any products contained in this publication in order to improve design, performance or reliability. EXAR Corporation assumes no representation that the circuits are free of patent infringement. Charts and schedules contained herein are only for illustration purposes and may vary depending upon a user's specific application. While the information in this publication has been carefully checked, no responsibility, however, is assumed for inaccuracies.

EXAR Corporation does not recommend the use of any of its products in life support applications where the failure or malfunction of the product can reasonably be expected to cause failure of the life support system or to significantly affect its safety or effectiveness. Products are not authorized for use in such applications unless EXAR Corporation receives, in writing, assurances to its satisfaction that: (a) the risk of injury or damage has been minimized; (b) the user assumes all such risks; (c) potential liability of EXAR Corporation is adequately protected under the circumstances.

Copyright 2013 EXAR Corporation

Datasheet May 2013

Send your serial transceiver technical inquiry with technical details to: serialtechsupport@exar.com

Reproduction, in part or whole, without the prior written consent of EXAR Corporation is prohibited.