

Surface Mount Power

COMMERCIAL

- RC Series: carbon composition (1/4 & 1/2 watt)
- RC Series: ceramic composition (above 1/2 watt)
- RF Series: metal film
- RW Series: wirewound
- RP Series: power film
- RM Series: high voltage thick film

FEATURES

- Tolerance 1%, 5%, 10%, depending on construction
- Twelve wattage ratings
- Seven package sizes
- Two mounting designs to accommodate your soldering process
- Five power resistor technologies to optimize your operating performance:
 1. Carbon and Ceramic composition for surge and low inductance
 2. Metal film for high ohmic value and low T.C.
 3. Wire element for inrush current combined with low ohmic values. Resistance values as low as 0.005Ω
 4. Power film for high ohmic value and high wattage
 5. High Voltage thick film for high voltage applications
- Flexible J-bend terminations
- Working Temperature Range: -55°C to +150°C

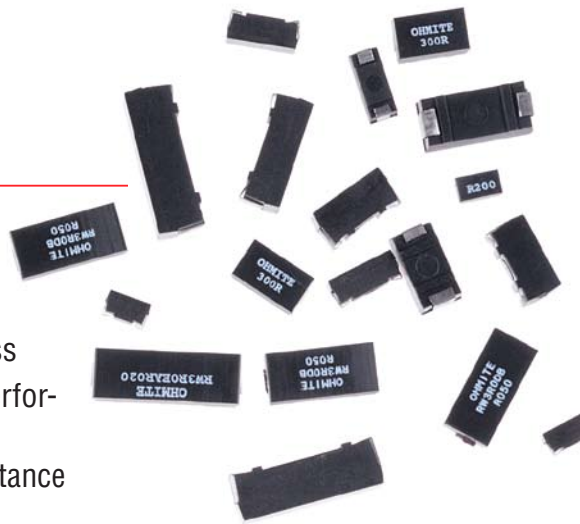
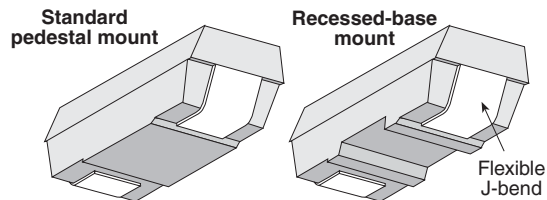

SERIES SPECIFICATIONS

Series*	Wattage	Ohms	Voltage
RC0S2CA	0.25	2.2–5.6M	250
RC0R5DB	0.50	2.2–20M	350
RW0S6BB	0.6	0.010-1K	50
RF0S8BA	0.80	1.0–10M	200
RW1S0BA	1.00	0.005–1K	50
RF1S0CA	1.00	1.0–10M	350
RC1R0EA	1.00	3.3–100K	500
RP1S3CA	1.25	1.0–1M	350
RW1S5CA	1.50	0.005–1.5K	75
RP1S5CB	1.50	1.0–1M	350

Series*	Wattage	Ohms	Voltage
RP1R5CB	1.50	1.0–1M	350
RW2S0CB	2.00	0.005–5K	100
RW2R0CB	2.00	0.005–5K	100
RP2S0DA	2.00	1.0–1M	500
RP2R0DA	2.00	1.0–1M	500
RW2S0DA	2.00	0.005–5K	100
RW2R0DA	2.00	0.005–5K	100
RP2R5DB	2.50	1.0–1M	500
RW3R0DB	3.00	0.005–13K	200
RP3R0EA	3.00	1.0–1M	750
RW3R5EA	3.50	0.005–25K	350

Military grade versions available; contact Ohmite.
*Last two digits designate package size

Surface Mount Power

COMMERCIAL

CHARACTERISTICS

Part Number	Power (watts)*	Maximum voltage	1% tol.	Resistance range 5% tol.	10% tol.	Temp. Coefficient 0.1Ω-1Ω	1Ω-10Ω	10Ω+	Dielectric Withstanding	Tape Size 13" reels	Quantity per reel
RC0S2CA	0.25	250	—	—	2.2Ω-5.6M	—	±400	±400	1000V	16mm	1500
RC0R5DB	0.50	350	—	—	2.2Ω-20M	—	±400	±400	1000V	24mm	1000
RW0S6BB	0.6	50	0.010Ω-1K	0.005Ω-1K	—	±90	±50	±20	1000V	12mm	2500
RF0S8BA	0.8	200	1Ω-5M	—	—	—	±100	±100	1000V	12mm	2000
RW1S0BA	1.0	50	0.005Ω-1K	0.005Ω-1K	—	±90	±50	±20	1000V	12mm	2000
RF1S0CA	1.0	350	10Ω-1M	1Ω-10M	—	—	±200	±100	1000V	16mm	1500
RC1R0EA	1.0	500	3.3-100K (10% tol only)			—	—	-1300	1000V	32mm	750
RP1S3CA	1.25	350	—	1Ω-1M	—	—	±250	±250	1000V	16mm	1500
RP1S5CA	1.5	75	0.005Ω-1.5K	0.005Ω-1.5K	—	±90	±250	±250	1000V	16mm	1500
RP1S5CB	1.5	350	—	1Ω-1M	—	—	±250	±250	1000V	16mm	1000
RP1R5CB	—	—	—	—	—	—	—	—	—	—	—
RW2S0CB	2.0	100	0.005Ω-5K	0.005Ω-5K	—	±90	±50	±20	1000V	16mm	1000
RW2R0CB	—	—	—	—	—	—	—	—	—	—	—
RP2S0DA	2.0	500	—	1Ω-1M	—	—	±250	±250	1000V	24mm	1000
RP2R0DA	—	—	—	—	—	—	—	—	—	—	—
RW2S0DA	2.0	100	0.005Ω-5K	0.005Ω-5K	—	±90	±50	±20	1000V	24mm	1000
RW2R0DA	—	—	—	—	—	—	—	—	—	—	—
RP2R5DB	2.5	500	—	1Ω-1M	—	—	±250	±250	1000V	24mm	1000
RW3R0DB	3.0	200	0.005Ω-13K	0.005Ω-13K	—	±90	±50	±20	1000V	24mm	1000
RP3R0EA	3.0	750	—	1Ω-1M	—	—	±250	±250	1000V	32mm	750
RW3R5EA	3.5	350	0.005Ω-25K	0.005Ω-25K	—	±90	±50	±20	1000V	32mm	750
RM0R7EA	0.75	2500	1KΩ-1000M	1KΩ-1000M	—	—	—	±50	1000V	32mm	750

*25°C ambient

PERFORMANCE DATA

Construction	Temp. cycle (-55°C to 125°C, 1000 cycles)	Load Life (1000 hours at 25°C)	Immersion (260°C for 10 sec.)	Momentary Overload
RC Carbon/Ceramic Comp.	±4.0%+.05Ω	±10.0%+.05Ω	±3.0%+.05Ω	6.3x rated power for 5 sec.
RF Metal Film	±0.5%+.05Ω	±0.5%+.05Ω	±0.1%+.05Ω	2x rated power for 0.1 sec.
RW Wirewound	±0.5%+.05Ω	±3.0%+.05Ω	±0.1%+.05Ω	5x rated power for 5 sec.
RP Power Film	±3.0%+.05Ω	±5.0%+.05Ω	±0.5%+.05Ω	2x rated power for 0.1 sec.
RN Wirewound, Non-inductive	±0.5%+.05Ω	±3.0%+.05Ω	±0.1%+.05Ω	5x rated power for 5 sec.
ALL models:	Leaching (260°C Solder immersion, 60 sec.).....			No visible leaching
	Thermal Shock (Units at -55°C, then rated power applied)..			No mechanical damage
	Flammability			UL Material rating, UL94V0

Derating

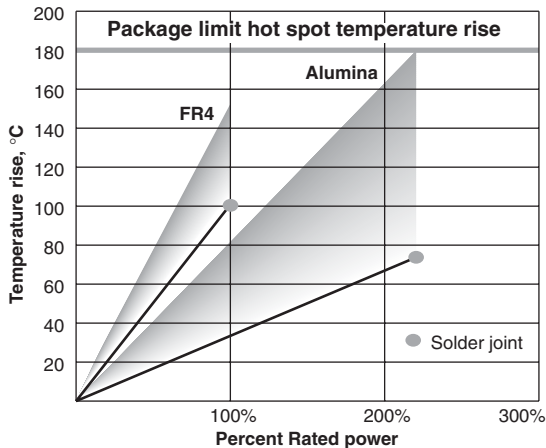
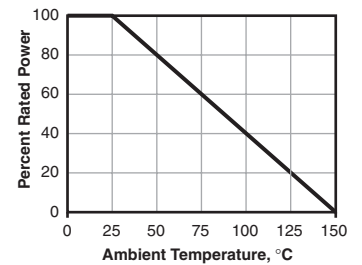

The temperature rise graph data was obtained by a selection of test substrate size and trace width for each resistor size to limit operating temperatures to safe values.

The operating temperature safe rises are either 100°C substrate temperature rise or 180°C package hot spot temperature rise at 25°C ambient.

FR4: 0.062 in. thick; 0.062 in. traces

Alumina: 0.040 in. thick; 0.010 in. traces

Molding material rated at 205°C continuous.

TCR

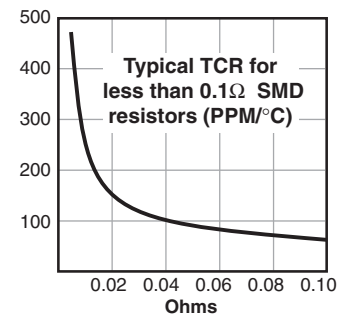

Surface Mount Power

DIMENSIONS

(in./mm)

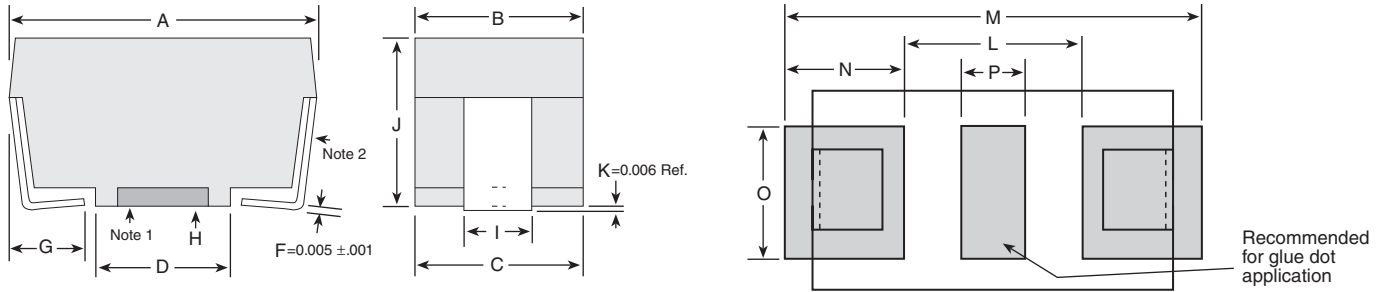

Package Outline Dimensions

PC Board Land Pattern

Packages	A	B	C	D	G	I	J	L	M	N	O	P
BA (in.)	.246±.020	.136±.005	.133 REF	.110±.010	.047 Nom.	.054±.012	.136±.005	.150	.346	.098	.126	.050
(mm)	6.248±.508	3.454±.127	3.378 REF	2.794±.254	1.194 Nom.	1.372±.305	3.454±.127	3.81	8.79	2.49	3.20	1.27
CA (in.)	.394±.020	.159±.005	.156 REF	.220±.010	.062 Nom.	.078±.012	.159±.005	.256	.524	.134	.126	.060
(mm)	10.008±.508	4.039±.127	3.962 REF	5.588±.254	1.575 Nom.	1.981±.305	4.038±.127	6.50	13.31	3.40	3.20	1.52
CB (in.)	.407±.020	.226±.005	.222 REF	.260±.010	.062 Nom.	.084±.012	.222±.005	.276	.537	.131	.126	.093
(mm)	10.338±.508	5.74±.127	5.639 REF	6.604±.254	1.575 Nom.	2.134±.305	5.639±.127	7.01	13.64	3.33	3.20	2.36
DA (in.)	.455±.020	.240±.005	.236 REF	.260±.010	.062 Nom.	.143±.012	.226±.005	.317	.585	.134	.155	.093
(mm)	11.557±.508	6.096±.127	5.994 REF	6.604±.254	1.575 Nom.	3.632±.305	5.740±.127	8.05	14.86	3.40	3.94	2.36
DB (in.)	.625±.020	.273±.005	.268 REF	.417±.010	.062 Nom.	.143±.012	.226±.005	.474	.742	.134	.155	.093
(mm)	15.875±.508	6.934±.127	6.807 REF	10.592±.254	1.575 Nom.	3.632±.305	5.740±.127	12.040	18.85	3.40	3.94	2.36
EA (in.)	.811±.020	.273±.005	.268 REF	.572±.010	.093 Nom.	.143±.012	.273±.005	.611	1.000	.195	.155	.093
(mm)	20.599±.508	6.934±.127	6.807 REF	14.529±.254	2.362 Nom.	3.632±.305	6.934±.127	15.52	25.4	4.95	3.94	2.36
BB (in.)	.202±.010	.10±.010	.095 REF	.079±.010	.050 Nom.	.065±.012	.135±.005	0.078	0.328	0.125	0.126	0.026
(mm)	5.140±.508	2.54±.127	2.41 REF	2.00±.254	1.280 Nom.	1.640±.305	3.420±.127	1.98	8.33	3.18	3.20	0.66

Note 1: Packages BA and CA are only available with a pedestal base. Packages CB and DA are available in either pedestal or recessed base. Packages DB and EA are only available in a recessed base.

Note 2: Test point is .020 above PCB.

Note 3: Tape and reel dimensions per EIA 481 A except "EA" size which is 12 mm component pitch versus 16mm pitch.

Land pattern dimensions are for reference only

Reel Dimensions

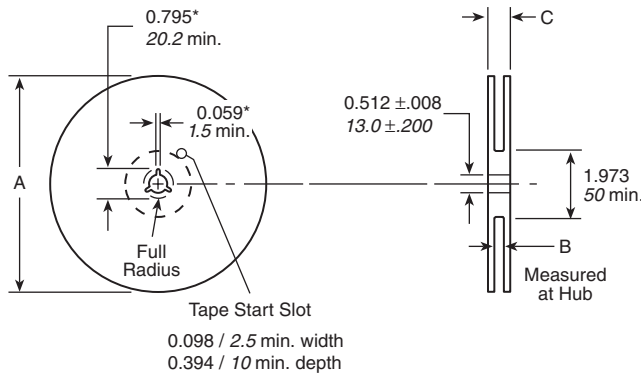

Size	A nom.	B	C max.	Quantity
12mm	13"	0.488" +0.078, -0.00	0.724"	2000 pcs. BA or
		12.4mm +2.0, -0.0	18.4mm	2500 pcs. BB
16mm	13"	0.646" +0.078, -0.00	0.882"	1500 pcs. CA or
		16.4mm +2.0, -0.0	22.4mm	1000 pcs. CB
24mm	13"	0.961" +0.078, -0.00	1.196"	1000 pcs. DA or DB
		24.4mm +2.0, -0.0	30.4mm	
32mm	13"	1.276" +0.078, -0.00	1.52"	750 pcs. EA
		32.4mm +2.0, -0.0	38.4mm	

All reels are compatible with major pick-and-place machines and made in accordance with EIA 481 A (except EA size, which is 12mm component pitch versus 16mm pitch).

Surface Mount Power

COMMERCIAL

ORDERING INFORMATION

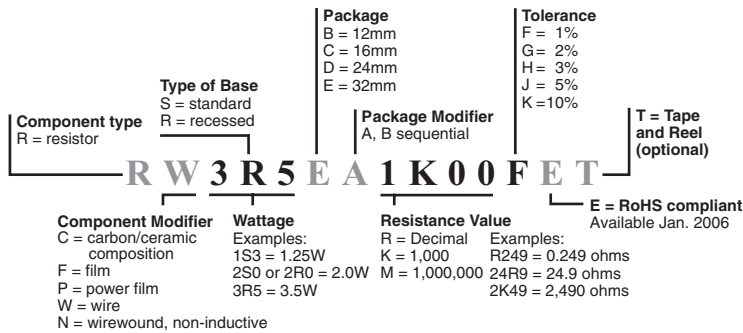

(For example, the part number shown is a wirewound resistor, 3.5 watt, recessed base, 32mm tape size, first case size [A], 1000 ohms 1% tolerance.)

Standard Part Numbers for Surface Mount Power Resistors

Ohmic value	Wirewound										
	Package style	BA	CA	CB	CB	DA	DA	DB	EA	BB	EA
	Base: standard or recessed	S	S	S	R	S	R	R	R	S	R
	Wattage	1.0	1.5	2.0	2.0	2.0	2.0	3.0	3.5	0.6	1.0
	Part No.	RW1S0BA	RW1S5CA	RW2S0CB	RW2R0CB	RW2S0DA	RW2R0DA	RW3R0DB	RW3R5EA	RW0S6BB	RC1R0EA
	Prefix										
	Suffix	Tolerance suffix: F = 1% J = 5% K = 10%									
0.005	R005	J	J		F/J						
0.010	R010	F/J	J	J	F	J	J	J	F		
0.015	R015	F/J	J						F		
0.020	R020	J	J	J	F	J		J	F		
0.025	R025	J									
0.027	R027	J									
0.030	R030	F	J	J				J	F		
0.033	R033	J									
0.036	R036	J									
0.050	R050	F/J	J	J	J	F	J	J	F		
0.056	R056	J									
0.075	R075	J							F		
0.080	R080	J						J			
0.100	R100	F/J	J	J	F	J	J	J	F		
0.150	R150	J	J	J	J						
0.200	R200	J	J					J			
0.220	R220	J	J								
0.240	R240	J	J						F		
0.300	R300	J		J							
0.330	R330			J							
0.400	R040	J									
0.400	R400			J							
0.470	R470	J	J			J			F		
0.500	R500	J	J		J			J			
0.750	R750	J							F		
1.00	R100	F/J	J	J		J	J		F		
2.00	R200								F		

Ohmic value	Wirewound										
	Package style	BA	CA	CB	CB	DA	DA	DB	EA	BB	EA
	Base: standard or recessed	S	S	S	R	S	R	R	R	S	R
	Wattage	1.0	1.5	2.0	2.0	2.0	2.0	3.0	3.5	0.6	1.0
	Part No.	RW1S0BA	RW1S5CA	RW2S0CB	RW2R0CB	RW2S0DA	RW2R0DA	RW3R0DB	RW3R5EA	RW0S6BB	RC1R0EA
	Prefix										
	Suffix	Tolerance suffix: F = 1% J = 5% K = 10%									
3.30	R330										K
4.70	R470										K
5.00	R500								F		
5.60	R560	J									
6.80	R680										K
7.50	R750							J	F		
10.00	R100	J	J	J		J			F	K	
15.00	R150	J	J						F	K	
20.00	R200			J							
22.00	R220										K
24.90	R249								F		
33.00	R330								F	K	
36.00	R360								F		
47.00	R470	J						J	F	K	
50.00	R500										
51.00	R510	J							J		
68.00	R680										K
82.00	R820				J						
100.00	R100			J					F	K	
120.00	R120		J								
180.00	R180	J									
300.00	R300	J									
470.00	R470					J					
1K	R1K00							J			K
4.7K	R4K70				J				J		
5K	R5K00								J		